

NON-CONFIDENTIAL
No. 2012-1338

UNITED STATES COURT OF APPEALS
FOR THE FEDERAL CIRCUIT

APPLE INC.,

Appellant,

– v. –

INTERNATIONAL TRADE COMMISSION,

Appellee,

and

MOTOROLA MOBILITY, INC.,

Intervenor.

ON APPEAL FROM THE UNITED STATES INTERNATIONAL TRADE COMMISSION
IN INVESTIGATION No. 337-TA-750

CORRECTED OPENING BRIEF AND ADDENDUM OF
APPELLANT APPLE INC.

Mark G. Davis
Weil, Gotshal & Manges LLP
1300 Eye Street, N.W., Ste 900
Washington, DC 20005

Matthew D. Powers
Tensegrity Law Group LLP
201 Redwood Shores Pkwy, Ste 401
Redwood Shores, CA 94065

E. Joshua Rosenkranz
Alyssa Caridis
Orrick, Herrington & Sutcliffe LLP
51 West 52nd Street
New York, NY 10019

Mark S. Davies
Rachel M. McKenzie
T. Vann Pearce
Amisha R. Patel
Orrick, Herrington & Sutcliffe LLP
1152 15th Street, N.W.
Washington, DC 20005

Attorneys for Appellant Apple Inc.

CERTIFICATE OF INTEREST

Counsel for appellant certifies the following:

1. We represent Apple Inc.
2. That is the real name of the real party in interest.
3. Apple Inc. has no parent corporation. No publicly held company owns 10 percent or more of Apple Inc.'s stock.
4. The following law firms and partners or associates appeared for Apple Inc. in the ITC or are expected to appear in this court:

ORRICK, HERRINGTON SUTCLIFFE LLP:

E. Joshua Rosenkranz
Mark S. Davies
Rachel M. McKenzie
T. Vann Pearce
Alyssa Caridis
Amisha R. Patel

WEIL GOTSHAL & MANGES LLP:

Carrie M. Anderson
Joshua A. Bachrach
Eva A. Belich
Jonathan Bloom
Carmen E. Bremer
Melissa Colon-Bosolet
Caitlyn M. Campbell
Anne M. Cappella
Brian C. Chang
Reed Collins
Justin L. Constant

WEIL GOTSHAL & MANGES LLP (continued):

Isaac S. Crum
Mark G. Davis
Timothy E. DeMasi
David M. DesRosier
Michael Eisenberg
Brian E. Ferguson
Erick Flores
Jacqueline T. Harlow (no longer with firm)
Erin Jones (no longer with firm)
Edward S. Jou
Jason D. Kipnis
Kevin Kudlac
Jason J. Lang
Kathy A. Le (no longer with firm)
Joseph H. Lee (no longer with firm)
Christopher T. Marando
Meghan A. McCaffrey
Arjun Mehra
Rodney R. Miller
Adrian C. Percer
Penny R. Reid
Danielle Rosenthal (no longer with firm)
Stephen K. Shahida
Caroline K. Simons
Stefani Smith (no longer with firm)
Christin Sullivan
Rachelle H. Thompson
Robert T. Vlasits
Megan H. Wantland
Robert Watkins (no longer with firm)
Elizabeth S. Weiswasser
Timothy C. Welch
Jeff L. White
Melissa J. Whitney
Jenny C. Wu (no longer with firm)
Patricia Young (no longer with firm)

COVINGTON & BURLING LLP:

Christopher K. Eppich
Samuel F. Ernst
Robert D. Fram
Jessica R. Gioia
Danielle L. Goldstein
Iris Y. Gonzalez
Leslie N. Harvey
Christine Saunders Haskett
Robert T. Haslam
Krista S. Jacobsen (no longer with firm)
R. Anthony Lopez
L.J. Chris Martiniak
Jeffrey T. Pearlman
Nathan Shafroth
Anupam Sharma
Ranganath Sudarshan
Winslow B. Taub

TENSEGRITY LAW GROUP LLP:

Steven S. Cherensky
Paul T. Ehrlich
Monica Mucchetti Eno
Robert L. Gerrity
Azra Hadzimehmedovic
Matthew D. Powers

BRIDGES & MAVRAKAKIS LLP

Lawrence Lien
Christopherh Lubeck
Michael T. Pieja
James A. Shimota

Dated: July 20, 2012

Respectfully submitted,

/s/ E. Joshua Rosenkranz

E. Joshua Rosenkranz

Orrick, Herrington & Sutcliffe LLP

51 West 52nd Street

New York, NY 10019

Attorney for Appellant

TABLE OF CONTENTS

	Page
TABLE OF AUTHORITIES	viii
STATEMENT OF RELATED CASES	xi
INTRODUCTION.....	1
JURISDICTIONAL STATEMENT	3
STATEMENT OF THE ISSUES.....	3
STATEMENT OF THE CASE	4
STATEMENT OF FACTS	5
Apple Makes It A Priority To Invent A Transparent Full Image Multi-Touch Sensor.....	5
Apple’s Engineers Choose One Tentative Path Among Many Possible Options	8
Apple’s Engineers Refine The Design.....	13
Apple Files For A Patent On Its New Touchscreen	19
The New Touchscreen Spurs The iPhone’s Spectacular Success.....	22
Motorola Copies Apple’s Touchscreen After Unsuccessfully Trying To Develop Its Own	25
The ITC Refuses To Bar Motorola’s Infringing Touchscreen Products.....	27
SUMMARY OF THE ARGUMENT	30
STANDARD OF REVIEW.....	34

ARGUMENT 35

I. THE ITC ERRED IN HOLDING THAT APPLE’S
TRANSPARENT FULL IMAGE MULTI-TOUCH SENSOR
WAS OBVIOUS..... 35

A. Apple’s Transparent Full Image Multi-Touch Sensor
Is Exactly The Type Of Innovation The Patent
System Is Meant To Foster 36

1. The prior art factors strongly support the
conclusion that the ’607 patent was not obvious 36

2. Objective indications reinforce the conclusion the
’607 patent was not obvious 44

B. The ITC’s Rationale For Finding Apple’s Touchscreen
Obvious Was Legally Flawed..... 48

II. THE ALJ ERRED IN HOLDING THAT THE PERSKI
PATENT ANTICIPATED APPLE’S TRANSPARENT FULL
IMAGE MULTI-TOUCH SENSOR 55

A. Motorola Did Not Sustain Its Burden Of Proving That
Perski’s Sensor Was Sufficiently Fast And Accurate
For Full Image Multi-Touch..... 56

1. Motorola presented no evidence that Perski’s
disclosed scanning algorithm can detect touches
“at the same time as viewed by a user” 57

2. Motorola presented no evidence that Perski’s
disclosed method can accurately detect multiple
touches 63

B. Perski Is Not Prior Art To The ’607 Patent 64

III. THE COMMISSION BASED ITS FINDING THAT THE ’828
PATENT WAS NOT INFRINGED ON THE ALJ’S
INCORRECT CONSTRUCTION OF THE
“MATHEMATICALLY FITTING AN ELLIPSE” TERM IN
THE ’828 PATENT..... 67

CONCLUSION 78

ADDENDUM

Notice Regarding Initial Determination on Violation of Section 337 and Recommended Determination on Remedy and Bond, Dated Jan. 13, 2012..... A33-34

Initial Determination on Violation of Section 337 and Recommended Determination on Remedy and Bond, Dated Jan. 13, 2012 (Excluding Attachments)..... A35-497

Notice of Commission Decision To Review in Part and on Review To Affirm a Final Determination Finding No Violation of Section 337; Termination of Investigation, Dated Mar. 16, 2012 A498-501

Commission Opinion, Dated Mar. 28, 2012..... A516-530

Patent No. 7,663,607, Dated Feb. 16, 2010 A531-563

Patent No. 7,812,828, Dated Oct. 12, 2010..... A564-648

Material has been deleted from pages 1, 6-14, 17-18, 25-27, 37-40, 45-46, 58-59, 61, and 77-78 of the Non-Confidential Opening Brief of Appellant Apple Inc. This material is deemed confidential business information pursuant to 19 U.S.C. § 1337(n) and 19 C.F.R. § 210.5, and pursuant to the Protective Order entered November 30, 2010, and the Orders Amending the Protective Order entered January 14, 2011, and June 16, 2011. The material omitted from these pages contains confidential deposition and hearing testimony, confidential business information, confidential patent application information, and confidential licensing information.

TABLE OF AUTHORITIES

	Page(s)
CASES	
<i>Akamai Techs., Inc. v. Cable & Wireless Internet Servs., Inc.</i> , 344 F.3d 1186 (Fed. Cir. 2003)	46
<i>Alco Standard Corp. v. Tennessee Valley Auth.</i> , 808 F.2d 1490 (Fed. Cir. 1986)	31, 44
<i>Allen Archery, Inc. v. Browning Mfg. Co.</i> , 819 F.2d 1087, 1092 (Fed. Cir. 1987)	44
<i>Apple Inc. v. Samsung Elecs. Co.</i> , No. 11-cv-01846, 2012 WL 1123752 (N.D. Cal. Apr. 4, 2012)	76
<i>Crocs, Inc. v. ITC</i> , 598 F.3d 1294 (Fed. Cir. 2010)	34, 45, 53
<i>In re Cyclobenzaprine Hydrochloride Extended-Release Capsule Patent Litig.</i> , 676 F.3d 1063 (Fed. Cir. 2012)	51, 52
<i>Diamond Rubber Co. v. Consol. Rubber Tire Co.</i> , 220 U.S. 428 (1911)	<i>passim</i>
<i>In re Giacomini</i> , 612 F.3d 1380 (Fed Cir. 2010)	65
<i>Graham v. John Deere Co.</i> , 383 U.S. 1 (1966)	36, 46, 52, 54
<i>Hybritech Inc. v. Monoclonal Antibodies, Inc.</i> , 802 F.2d 1367 (Fed. Cir. 1986)	52
<i>Innovention Toys, LLC v. MGA Entm’t, Inc.</i> , 637 F.3d 1314 (Fed. Cir. 2011)	40
<i>KSR Int’l Co. v. Teleflex, Inc.</i> , 550 U.S. 398 (2007)	<i>passim</i>

Mahurkar v. C.R. Bard, Inc.,
79 F.3d 1572 (Fed. Cir. 1996) 65

McGinley v. Franklin Sports, Inc.,
262 F.3d 1339 (Fed. Cir. 2001) 54

Microsoft Corp. v. i4i Ltd. P’ship,
131 S. Ct. 2238 (2011)..... 54, 56, 62

Mintz v. Dietz & Watson, Inc.,
679 F.3d 1372 (Fed. Cir. 2012) *passim*

Nippon Steel Corp. v. United States,
458 F.3d 1345 (Fed. Cir. 2006) 34

Ortho-McNeil Pharm., Inc. v. Mylan Labs., Inc.,
520 F.3d 1358 (Fed. Cir. 2008) 52

Power-One, Inc. v. Artesyn Techs., Inc.,
599 F.3d 1342 (Fed. Cir. 2010) 44

Radio Steel & Mfg. Co. v. MTD Prods., Inc.,
731 F.2d 840 (Fed. Cir. 1984) 76

In re Roemer,
258 F.3d 1303 (Fed. Cir. 2001) 43

Rolls-Royce, PLC v. United Techs. Corp.,
603 F.3d 1325 (Fed. Cir. 2010) 39

Sinorgchem Co., Shandong v. ITC,
511 F.3d 1132 (Fed. Cir. 2007) 74

Sorenson v. ITC,
427 F.3d 1375 (Fed. Cir. 2005) 34

Trintec Indus., Inc. v. Top-U.S.A. Corp.,
295 F.3d 1292 (Fed. Cir. 2002) 32, 56

Vizio, Inc. v. ITC,
605 F.3d 1330 (Fed. Cir. 2010) 34

Zenon Envt’l, Inc. v. U.S. Filter Corp.,
 506 F.3d 1370 (Fed. Cir. 2007) 67

CONSTITUTION AND STATUTES

U.S. Const. art. 1, § 8, cl. 8..... 2, 55
 19 U.S.C. § 1337 3, 4
 28 U.S.C. § 1295 3
 35 U.S.C. § 102 56
 35 U.S.C. § 103 35

REGULATIONS

19 C.F.R. § 210.42 30

MISCELLANEOUS

Apple Inc. Annual Report (Form 10-K) (Oct. 26, 2011),
<http://investor.apple.com/secfiling.cfm?filingID=1193125-11-282113&CIK=320193> 24, 46
 Steve Jobs, CEO, Apple Inc., Address at the Macworld Conference
 and Expo (Jan. 9, 2007),
<http://www.iphonebuzz.com/complete-transcript-of-steve-jobs-macworld-conference-and-expo-january-9-2007-23447.php> 23
 Richard L. Robbins, *Subtests of “Nonobviousness”: A Nontechnical Approach to Patent Validity*,
 112 U. Pa. L. Rev. 1169 (1964) 46
 Lance Whitney, *Apple Crowned Top Smartphone Vendor of 2011*
By Gartner, CNET, Feb. 15, 2012,
http://news.cnet.com/8301-13579_3-57378209-37/apple-crowned-top-smartphone-vendor-of-2011-by-gartner/..... 24, 46

STATEMENT OF RELATED CASES

No other appeal from this International Trade Commission (“ITC”) proceeding was previously before the Court or any other appellate court.

There are no cases that will directly affect or be directly affected by the Court’s decision in the pending appeal. Apple Inc. (“Apple”) filed a complaint with the ITC alleging (as relevant here) that Motorola Mobility, Inc. (“Motorola”) is infringing Apple’s patents including (as relevant here) U.S. Patent Nos. 7,633,607 and 7,812,828. A case pending between Apple and Samsung Electronics Co. originally involved the patents at issue here, but the claims involving both patents were dismissed without prejudice. *Apple Inc. v. Samsung Elecs. Co.*, Case No. 11-CV-01846-LHR (N.D. Cal. filed Apr. 15, 2011). There are several other district court actions in which Apple has alleged that Motorola and other makers of electronic devices infringe different Apple patents.

**Confidential
Material Omitted**

INTRODUCTION

Rarely has one product revolutionized an industry as Apple's touchscreen has. Just five years after Apple released the iPhone, it is hard to remember a time when we did not routinely touch the screens of our cell phones, tablets, and other portable electronic devices with our fingers. We did not tap to select "apps"; flick our index finger through articles, books, photographs, and music; or pinch our fingers together or apart to zoom in and out of pictures, maps, and text. We commanded our devices with keypads, track balls, or styluses.

One reason it is hard to remember that world is that virtually every major device manufacturer has mimicked Apple's patented touchscreen. This case is about one such copycat. Motorola tried to develop a useful touchscreen of its own, but failed. When Apple routed Motorola in the marketplace, [REDACTED] and copied Apple's hardware and software.

After Motorola initiated a patent attack against Apple in the fall of 2010, including in the ITC, Apple brought this action. Without a hint of irony, Motorola defended on the ground that this revolutionary technology—which the once-prolific innovator could not figure out for

itself—was obvious and anticipated. The ITC agreed and invalidated one of Apple’s core patents. It gutted another patent by construing a critical claim limitation in a nonsensical way that neither party had proposed.

Those rulings are wrong—and detrimental to future innovation. Apple is “unique” among its competitors because “it designs and develops nearly the entire solution for its products, including the hardware, operating system, numerous software applications, and related services.” A14,162. The development of both hardware and software is expensive. Apple “must make significant investments in research and development” and has protected its investments by obtaining “a significant number of patents.” *Id.* Here, Apple’s investments resulted in a patent on a “transparent” touch sensor that can “detect multiple touches or near touches that occur at a same time and at distinct locations.” A561, col. 21:34-41. Apple has invested in innovation expecting that the patent system “promote[s] ... Progress,” U.S. Const. art. 1, § 8, cl. 8, by rewarding innovation. When an agency invalidates or guts patents as path breaking as these, it discourages further investment and restrains Progress.

JURISDICTIONAL STATEMENT

Apple invoked the ITC's authority under Section 337 of the Tariff Act of 1930, as amended. A737. *See* 19 U.S.C §§ 1337(a)(1)(B)(1), (b)(1). On March 28, 2012, the ITC issued its final determination finding no violation of Section 337. A529. Apple timely filed its petition for review on April 12, 2012. *See* 19 U.S.C. § 1337(c); 28 U.S.C. § 1295(a)(6).

STATEMENT OF THE ISSUES

Apple's skilled engineers created the first touchscreen that could accurately and quickly sense and interpret multiple touches on a transparent screen. That touchscreen spurred the spectacular success of a revolutionary electronic device, the iPhone. The questions presented are:

1. Did the ITC err in declaring the patented touchscreen obvious, where (i) Apple alone recognized the problem with existing user interfaces and thus Apple alone saw a reason to combine technologies to create a new user interface; (ii) Apple's engineers had to overcome significant technical problems to make the touchscreen work; (iii) the touchscreen was largely responsible for the praise, copying, and

commercial success of the iPhone; and (iv) the Patent and Trademark Office granted Apple a patent fully aware of the cited prior art?

2. Did the ITC err in finding that another prior art reference anticipated Apple's new touchscreen where the reference (i) teaches only a touchscreen that senses "a single touch[]" by "either a finger or a special stylus"; (ii) operates differently; and (iii) does not predate Apple's invention?

3. Did the ITC err in superimposing on the claim term "mathematically fitting an ellipse" in another Apple patent the anachronistic requirement that the software "actually" fit an ellipse *before* ellipse parameters are calculated even though that was contrary to both the parties' proposed claim constructions and the patent's preferred embodiment?

STATEMENT OF THE CASE

On October 29, 2010, Apple filed a complaint with the ITC under 19 U.S.C. § 1337, alleging that Motorola's products infringed three Apple patents. Two—U.S. Patent Nos. 7,633,607 and 7,812,828—are at issue in this appeal. (Apple does not seek review on the third patent, which will expire in August 2013.) The ITC initiated an investigation.

On January 13, 2012, Administrative Law Judge (“ALJ”) Theodore Essex issued an initial determination finding that Motorola did not violate Section 337. Apple petitioned the ITC for review. Motorola filed a contingent petition. The ITC granted review in part on March 16, 2012, and affirmed the finding of no violation on March 28, 2012.

STATEMENT OF FACTS

Apple Makes It A Priority To Invent A Transparent Full Image Multi-Touch Sensor

Before the iPhone, no one was touching transparent screens on handheld devices in the fashion we routinely do now. There were transparent touchscreens that could detect a *single* touch in a specific spot—like an ATM that beeps in confused protest when you accidentally touch two places at once. A6657. There were also transparent screens that could *sometimes* detect more than one touch—depending upon exactly where on the screen they were—but not always and not reliably. A551, col. 2:3-9, 16-22; A7164, 7382. In industry parlance, these were not “full image” touchscreens. Engineers had figured out ways to provide full image multi-touch capability only on *opaque* surfaces.

**Confidential
Material Omitted**

Thus, for example, they could embed the requisite sensors in the now-familiar laptop trackpad:



**Opaque Touch-Pad
(Cannot Have LCD Display Under Touch Pad)**

A6711. But no one had invented a *transparent, full image* touchscreen that accurately detected and responded to multiple touches at once, regardless of where the screen is touched, in a way that has now become standard.

In the summer of 2003, Steve Jobs, then CEO of Apple, aspired to devise a touchscreen unlike any other. Jobs had long focused on how users interact with electronic devices. He had led Apple to develop the Mac with its metaphorical desktop and user-friendly mouse. Then came the iPod with a click wheel. He imagined an encore performance even more revolutionary than what came before. [REDACTED]

**Confidential
Material Omitted**

[REDACTED] A15,431; *see*
A30,258-59.

So, at Jobs’s direction, Apple set out to achieve what no one else
had ever done. A15,431; *see* A30,233-35. Running the touchscreen
effort was Steve Hotelling, [REDACTED]

[REDACTED]

A15,431, A7379-80. Hotelling knew it was a head-scratcher— [REDACTED]

[REDACTED]

[REDACTED] A15,431. [REDACTED]

[REDACTED]

[REDACTED] *Id.* (emphasis added).

But the challenge energized him, because [REDACTED]

[REDACTED]

[REDACTED] *Id.* (emphasis

added); *see* A30,257-58.

The team was not lacking in experience or expertise. A named
inventor of more than 50 patents, A30,144, Hotelling was a Stanford-
trained electrical engineer, A7379. By the time he joined Apple in 2002,
he had spent a decade inventing solutions for input devices. A7379,

**Confidential
Material Omitted**

13,719, 30,216-17. Hotelling hired Josh Strickon, who had three degrees (including a Ph.D.) from the Massachusetts Institute of Technology. A15,557. His master’s thesis project at MIT was a multipoint touchscreen using a fiber optic touch pad. *Id.*

Apple’s Engineers Choose One Tentative Path Among Many Possible Options

For all its intellectual firepower and experience, the team did not hit upon a solution quickly or directly. It got there through inspired guesswork, parallel research tracks, a few false starts, and healthy doses of ingenuity.

As if to illustrate the numerous challenges for posterity, early in the life of the project, [REDACTED]

[REDACTED]

[REDACTED] A15,733 (emphasis added).

[REDACTED] *Id.*;

A15,742-48. [REDACTED]

[REDACTED] A15,733.

Step one was a bet on which of the several approaches was most promising. As the project started, [REDACTED]

[REDACTED] A15,431. [REDACTED]

**Confidential
Material Omitted**

 *Id.* Capacitance is an object’s ability to store electricity. Capacitance sensing is based on the simple fact that when a finger approaches a charged object, it sucks electrons from the object. A555, col. 9:23-26. The stolen electrons cause a tiny reduction in the object’s capacitance. A555, col. 9:26-31; A30,230. The typical way to measure this change was with a tiny voltmeter. A555, col. 9:31-36; *see* A31,728-29.

Step two was to figure out what to make the sensor out of. Hotelling chose indium tin oxide, or “ITO.” A7643, 15,431. ITO has the advantage of being relatively transparent when painted in a thin layer over a surface, A30,262-63, but it is not completely transparent, which presented some problems. It also conducts electricity, but unfortunately very poorly, which presented other problems.

Step three was how to deal with the transparency problems—specifically, how to enable a display to shine through a layer of ITO without illuminating a distracting pattern of sensors and circuits etched across the face of the screen. 





**Confidential
Material Omitted**

[REDACTED]

[REDACTED] A15,431. [REDACTED]

[REDACTED] *Id.*

[REDACTED]

[REDACTED]

[REDACTED]

[REDACTED] A7643 (emphasis added).

[REDACTED]

**Confidential
Material Omitted**

Id.

[REDACTED]

[REDACTED]

[REDACTED] A7644. By “pixel array,” Hotelling was referring to rows and columns of individual sensors. *Id.*; 30,266-67. The ITO (or other conductive medium) is painted onto the screen and etched into a checkerboard pattern. Each tiny square is an individual sensor separated from the others by tiny channels. A30,233; *see* A553, col. 5:29-34. It is therefore called “*self*-capacitance.” A533, col. 5:29-34. In order for each box in the checkerboard to act as an individual sensor, it was necessary to run a lead from each box to a capacitive sensing circuit. The circuitry for each box had to be crammed in the channels running between the checkerboard rows and columns. [REDACTED]

[REDACTED]

[REDACTED]

[REDACTED]

**Confidential
Material Omitted**

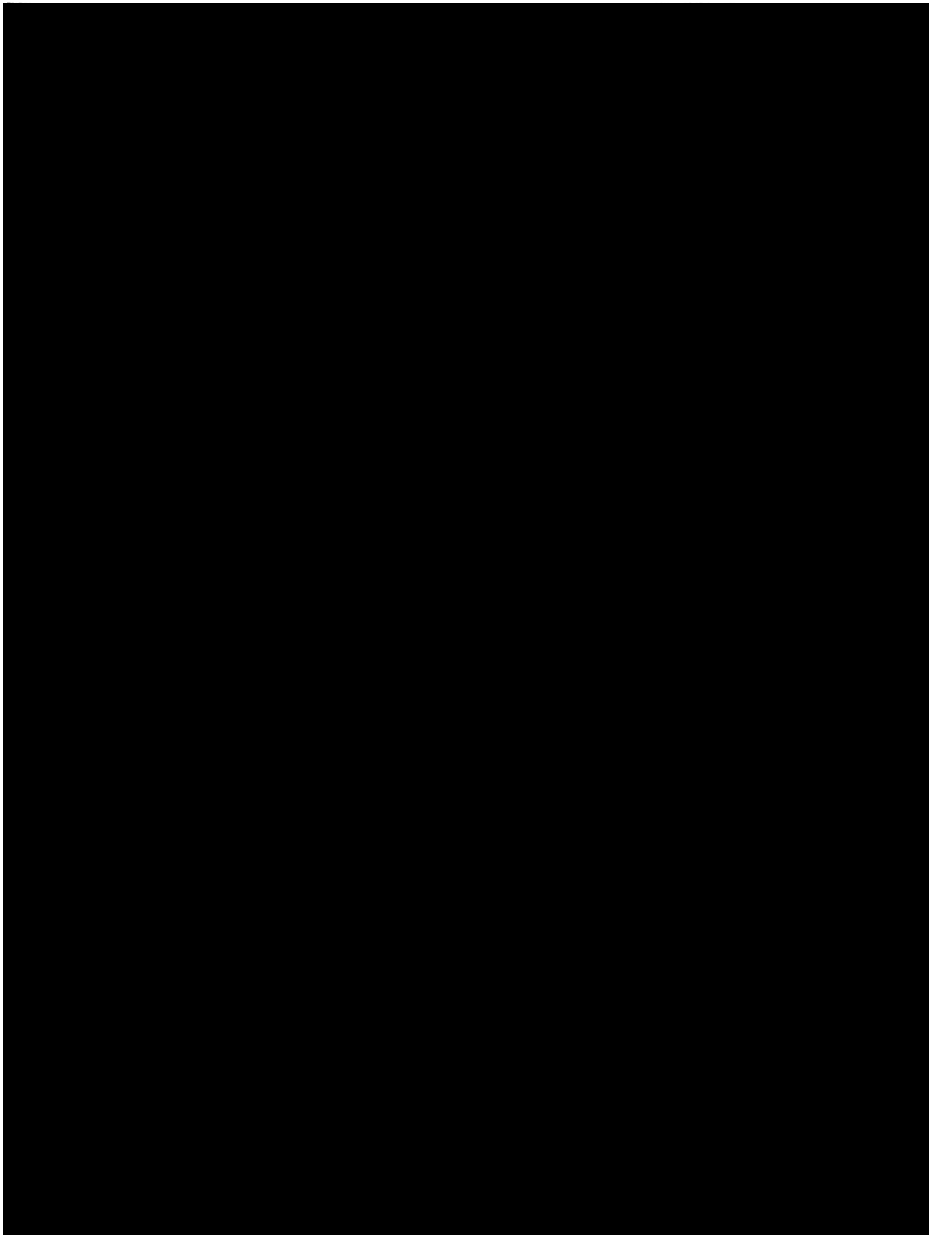

A7644.

Ingenious. But, as with any experimental technology, the solution raised more problems. One problem, [REDACTED]

[REDACTED]

[REDACTED]

**Confidential
Material Omitted**

A7643; see A542, fig. 7 (depicting an illustrative pattern). [REDACTED]

[REDACTED]

[REDACTED] A13,878. [REDACTED]

[REDACTED]

[REDACTED]

[REDACTED] A7643.

Apple’s Engineers Refine The Design

Not satisfied that the particular capacitance design that Hotelling sketched was perfect, the Apple team examined all sorts of multi-touch demonstrations on *opaque* surfaces in the hopes of learning something about how best to apply the technology to *transparent* surfaces.

A13,877, 15,422-23, 16,145. They also [REDACTED]

[REDACTED] A13,878.

One of the most fruitful contacts was with a company named FingerWorks. A7402-03, 13,874. One of FingerWorks’ most intriguing inventions was a way of detecting the size, shape, and relative position of each touch. Earlier methods of processing touch data could not distinguish between a finger tap and a pinch or finger and a palm. A13,263. But FingerWorks figured out a way that could distinguish

**Confidential
Material Omitted**

among many types of hand touches and gestures. A618-19, col. 6:66-7:46; A7339-400, 30,041-45, 30,357-59. The solution was software that mathematically converted each cluster of touched electrodes into parameters defining an ellipse. A7399-402. By 2003, *The New York Times*, *Time*, and *Wired* had all praised the software in FingerWorks' multitouch keyboards. A7408-09, 7485-87.

FingerWorks' devices were opaque. Unlike small trackpads on laptops, FingerWorks had developed capacitive touch sensors on large opaque multi-touch surfaces that replaced keyboards and mice. A7399-400, 7402-03, 30,338-39. FingerWorks had never layered a capacitive sensor over a transparent screen. A15,515-16, 30,251. [REDACTED]

[REDACTED]
[REDACTED] A15,516. But they agreed to collaborate with Apple to give it a try. Eventually, Apple acquired FingerWorks. A7418. With it, Apple also acquired a groundbreaking patent—the '828 patent—covering FingerWorks' ellipse-fitting multi-touch process. A7420, 7452; *see* A565 (assignee).

The Apple team also drew lessons from an approach that Sony Computer Science Laboratories developed. Sony described its approach

in an article entitled, *SmartSkin: An Infrastructure for Freehand Manipulation on Interactive Surfaces*. A13,597-604. SmartSkin involves a “grid” of “copper wires” running vertically and horizontally. A13,598. Each “crossing point” in the grid “acts as a (very weak) capacitor.” *Id.* When a “conductive and grounded object”—e.g., a finger—“approaches a crossing point,” it sucks electrons away from the grid. *Id.* “As a result, the received signal” becomes “weak” and by “measuring this effect, it is possible to detect proximity of a conductive object.” *Id.* Because the change in capacitance is measured by comparing a horizontal wire to a vertical one, A30,032, this design is called “mutual capacitance,” as distinguished from “self capacitance.” A555, col. 9:52-62.

Like conventional input devices, the SmartSkin sensor was opaque; that was the only way to hide the copper wires. Sony’s engineers were not focused on transparent touchscreens. Their agenda was to “extend[] [the] computerized workspace *beyond* the computer screen” by “turn[ing] *real-world surfaces, such as tabletops or walls*, into interactive surfaces.” A13,597 (emphasis added). They would project images onto those surfaces (and onto the user’s hand) as depicted below.

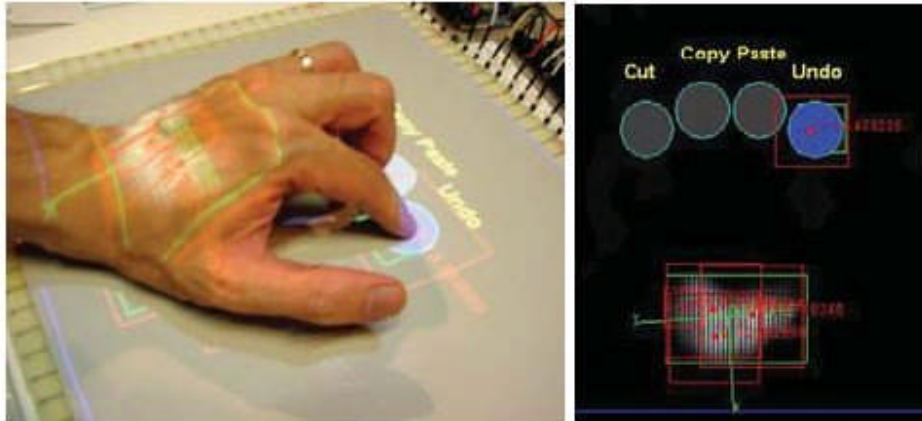

Figure 14: A palm is used to trigger a corresponding action (opening menu items). The user then taps on one of these menu items.

A13,601.

In a section entitled “Conclusions and Directions for Future Work,” the SmartSkin article provides a few sentences on four “research directions” that the authors were “interested” in maybe some day exploring. A13,603. For example, they dreamed of inventing “pet robots” that “would behave more naturally when interacting with humans” and devices that could “infer the user’s emotions.” *Id.* The final possible direction was the “[u]se of transparent electrodes.” *Id.* None of these suggestions for future work included any detail about how to make the sensor. Nearly 10 years after SmartSkin was published, Sony’s engineers never created a transparent sensor and, so far as appears from the record, they never even tried. It remained in

**Confidential
Material Omitted**

the dusty folder of ideas abandoned as impractical or pointless, along with the empathetic robotic Fido.

[REDACTED]

[REDACTED]

A16,145 (emphasis added). [REDACTED] A30,271-73.

As intriguing as the SmartSkin approach was, the Apple team did not drop everything to pursue it. [REDACTED]

[REDACTED]

A14,335. [REDACTED]

[REDACTED]

[REDACTED]

[REDACTED]

[REDACTED]

[REDACTED] *Id.*

Translating the SmartSkin approach to a transparent screen presented numerous quandaries. The main problems arose from the huge difference in conductivity between the copper wires that SmartSkin used and the transparent ITO in Apple's adaptation.

**Confidential
Material Omitted**

Copper “has a very high conductivity” (or low resistance). A31,782. Even with the very conductive copper wire, the capacitance signal that the SmartSkin grid generates is “very weak,” A13,598, and becomes weaker still upon the touch of a finger. But the difference is detectable with a sensitive voltmeter. In contrast to copper wires, ITO has a very low conductivity (or high resistance). A31,783. The difference is at least 100-fold. *Id.*; see A14,576. When the electrons are slogging through ITO, they have even lower energy, so the capacitance signal starts out 100 times weaker than it is in copper. A31,783. This makes it even harder to detect the (even tinier) downward fluctuation a finger touch causes, A14,576, 15,561, and extremely difficult to do so with a voltmeter, A31,783.

Existing solutions were unsatisfactory. [REDACTED]

[REDACTED]

[REDACTED] A14,335.

They figured out that they could discern whether a finger was draining electrons by literally counting electrons (i.e., charge) at the measuring point, rather than measuring their energy (i.e., voltage). A545, figs. 12-13; A559, col. 17:12-61; A31,728-29, 31,773, 31,780-81, 31,784. While it

was generally known “that you could count charge,” “prior to the ’607, no one figured out ... that you could finally get to use ITO in these mutual capacitance systems that implement multi-touch” by counting charge. A31,731-32.

Apple’s engineers also solved several other “significan[t] complexities” in mounting a transparent sensor in front of a display. A15,565-66. Most significant of these was that “the patterned ITO can become *quite visible*,” i.e., no longer transparent, “thereby producing a touch screen with undesirable optical properties.” A557-58, col. 14:65-15:3; *see* A7643, 13,875, 15,565-66. The ’607 patent details several solutions, including an elaboration on Hotelling’s ITO caulking idea. A556-59, col. 12:24-13:6, 14:60-17:11.

Apple Files For A Patent On Its New Touchscreen

In May 2004, the Apple engineers filed the patent application that ultimately became the ’607 patent. The application summarized existing touchscreen technologies and explained their inability to detect multiple touches accurately. A7164, 7382, 8845-46, 6663-66, 30,028-29; *see* A551, col. 1:34-2:22.

The application illustrates a mutual capacitance sensor. A8892, figs. 9-10; A8894, figs. 12-13; *see also* A557-59, col. 13:7-16:49, 17:12-61.¹ The mutual capacitance embodiment uses a screen built with multiple (almost) transparent layers. A543, fig. 10; A553, col. 5:47-49; A557, col. 13:62-64. On one layer is a set of parallel “driving” lines and on another is a set of parallel “sensing” lines, placed orthogonally to the driving lines. A543, fig. 9; A553, col. 5:49-50; A557, col. 13:62-66. Each intersection forms a capacitive coupling node that can sense a finger touch. A543, fig. 9; A553, col. 5:50-60; A557, col. 13:16-20.

The touch panel’s circuitry sends current through each row (the driving lines) in rapid succession while continuously checking all columns (the sensing lines) for changes in capacitance using the charge-counting method described above. A553, col. 5:62-65. After all rows are driven and all nodes are scanned, the sequence starts over. A557, col. 13:45-48. Using this method, the touch panel scans quickly enough to report touch information for each node “at about the same time (as

¹ The ’607 patent application also illustrates a self capacitance device like the one Hotelling sketched in September. A8890-91; *see also* A7644. But Apple eventually cancelled these self capacitance claims. A10,412-15.

viewed by a user) so as to provide multipoint sensing.” A559, col. 17:33-35.

After sensing any change in capacitance, the touch panel circuitry interprets the changes to accurately detect multiple touches. Figure 3 shows multiple objects in contact with the touch panel (contact patches 44), with each touch spanning multiple sensing nodes (42):

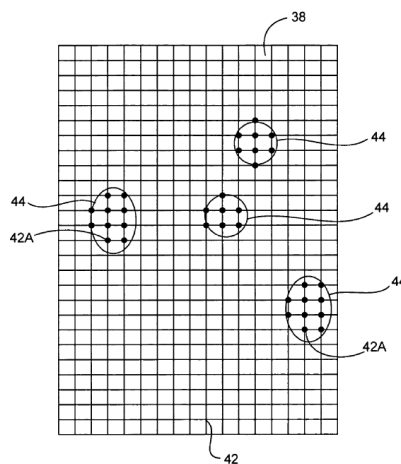

FIG. 3

A539, fig. 3; A553, col. 6:7-14. The touch panel circuitry recognizes these changes in capacitance as four different touches at distinct locations. A553, col. 6:14-25. It then reports touch information to a host device, such as a handheld device or tablet. A552-53, col. 4:28-30, 6:35-40.

Apple informed the Patent and Trademark Office (“PTO”) about the SmartSkin article. A8937-44, 9268-75. The examiner reviewed the

article twice (in 2005 and again in 2006), A9938, 9961, but nevertheless found the invention patentable, A9943-44; *see also* A10,140, 10,427-28.

In 2010, after six years of study, the PTO issued the '607 patent, entitled "Multipoint Touchscreen." A532. Claim 1 provides in relevant part:

A touch panel comprising a transparent capacitive sensing medium *configured to detect multiple touches or near touches that occur at a same time and at distinct locations* in a plane of the touch panel and to produce distinct signals representative of a location of the touches on the plane of the touch panel for each of the multiple touches

A561, col. 21:35-41 (emphasis added). The emphasized words are referred to as the "multi-touch limitations." Claim 10 has substantially similar text. *See* A561, col. 22:23-35.

The New Touchscreen Spurs The iPhone's Spectacular Success

While the lengthy patent prosecution was running its course, Steve Jobs introduced Apple's iPhone during his 2007 Macworld Conference keynote presentation. A30,130. Front and center was the transparent multi-touch user interface: "[W]e have invented a new technology called multi-touch, which is phenomenal. It works like magic. You don't need a stylus. It's far more accurate than any touch display that's ever been shipped. It ignores unintended touches, it's

super-smart. You can do multi-finger gestures on it. And boy, have we patented it.”²

Industry observers were blown away. One prominent critic lauded “Apple’s Magic Touch Screen.” A7826-27. The “sophisticated multipoint touch screen,” he enthused, is “the most impressive feature of the new iPhone.” A7826. *Time* named the iPhone “invention of the year.” A7483-84. And it singled out the touchscreen for special plaudits: “Because there’s no intermediary input device—like a mouse or a keyboard—there’s a powerful illusion that you’re physically handling data with your fingers.” A7490.

Consumers agreed. iPhones flew off the shelves. When Apple released the iPhone in June 2007, “analysts were speculating that customers would snap up about 3 million units by the end of 2007, making it the fastest-selling smartphone of all time.” A8259. Within a mere four years, iPhone sales reached into the *billions* of dollars. Over the past three years, net sales rocketed from \$6.7 billion in 2008 to \$47

² Steve Jobs, CEO, Apple Inc., Address at the Macworld Conference and Expo (Jan. 9, 2007), *available at* <http://www.iphonebuzz.com/complete-transcript-of-steve-jobs-macworld-conference-and-expo-january-9-2007-23447.php>.

billion in 2011. A14,184; Apple Inc. Annual Report (Form 10-K) 32 (Oct. 26, 2011).³ In 2011 alone, Apple sold an eye-popping 72 million iPhones worldwide, almost twice the 40 million units sold the previous year. 2011 Apple 10-K at 31-32; A14,184. Those sales figures translated into a 19% share of the worldwide smartphone market in 2011.⁴

The revolutionary touchscreen contributed to the success of Apple's next market sensation—the iPad, which Apple released to similar acclaim in 2010. A14,155. Within five months, the iPad had already netted nearly \$5 billion. A14,185. Once again, the iPad “left nearly every other big computer and consumer-electronics maker racing to get into the tablet market that [Apple’s] iPad had suddenly created.” A17,715.

³ Available at <http://investor.apple.com/secfiling.cfm?filingID=1193125-11-282113&CIK=320193> (“2011 Apple 10-K”).

⁴ Lance Whitney, *Apple Crowned Top Smartphone Vendor of 2011 By Gartner*, CNET, Feb. 15, 2012, http://news.cnet.com/8301-13579_3-57378209-37/apple-crowned-top-smartphone-vendor-of-2011-by-gartner/.

**Confidential
Material Omitted**

Motorola Copies Apple's Touchscreen After Unsuccessfully Trying To Develop Its Own

While Apple was developing its new touchscreen, Motorola had also been working on a touchscreen. It bet on resistive, instead of capacitive, technology. A30,140-41, 31,052-54. Resistive touchscreens include an electrically conductive panel and an electrically resistive panel that meet when the top panel is touched. A551, col. 1:38-43. In 2006, Motorola released a phone called "Ming" with a resistive touchscreen. A30,141, 31,052-54. But, [REDACTED] and as Apple's '607 patent notes, these resistive touchscreens could not detect multiple touches. A551, col. 1:63-2:3; see A30,141-42, 31,055-56.

For a time, the crudeness of Motorola's touchscreen did not matter. Motorola enjoyed a 22% market share in 2006, A8255, and made what "was once the top-selling U.S. handset," A8252. But immediately after the iPhone came out Motorola's market share "plummeted" to "around 4.5% in 2009"—a fifth of where it stood three years earlier. A8249, 8252. Industry analysts were already writing Motorola's obituary, fretting that Motorola was "stuck heavily in [a] handset death spiral." A8249.

**Confidential
Material Omitted**

Motorola's only hope was to produce a multi-touch screen that could compete with Apple's. [REDACTED]

[REDACTED]

[REDACTED] A7496 (emphasis added), [REDACTED]

[REDACTED]

[REDACTED] *Id.* [REDACTED]

[REDACTED]

[REDACTED] *Id.*; see A12,858-59

[REDACTED]

[REDACTED] That was more than four years after Hotelling's Eureka moment.

[REDACTED]

[REDACTED] A7511. [REDACTED]

[REDACTED] A7546. [REDACTED]

[REDACTED]

A7498. [REDACTED] A7552. [REDACTED]

[REDACTED]

[REDACTED]

**Confidential
Material Omitted**

[REDACTED] A7554. [REDACTED]

[REDACTED]

The ITC Refuses To Bar Motorola’s Infringing Touchscreen Products

Apple filed a complaint with the ITC seeking to exclude Motorola’s infringing products. A717-40. It asserted infringement of claims 1-7 and 10 of the ’607 patent (claims 2-7 depend from claim 1) and claims 1, 2, 10, 11, 24-26, and 29 of the ’828 patent, as well as another patent not raised in this appeal. A730. It accused 18 Motorola mobile devices of infringing both the ’607 and ’828 patents, and another three products of infringing just the ’828 patent. A47.

The ALJ opinion. The ALJ found no violation. A36. With respect to the **’607 patent**, the ALJ found that all 18 of the accused Motorola devices infringe all asserted claims. A148-68, 244. But he found no violation because he believed the ’607 patent was invalid as both obvious and anticipated. A244.

Specifically, the ALJ found all asserted claims obvious in light of Sony’s SmartSkin combined with another reference by the SmartSkin author, Unexamined Japanese Patent Application No. 2002-342033A (“Rekimoto ‘033”) that is no longer relevant on appeal (because the ITC

declined to rely on it with regard to the claim limitations at issue here, A523). A213-16. The ALJ acknowledged both “the iPhone 4’s commercial success,” A216-17, and that the iPhone practices the patent, A238-42. But he concluded that objective indications of nonobviousness “cannot overcome the strong showing of obviousness in this instance.” A216-17.

The ALJ did not believe that SmartSkin anticipated the invention claimed in the ’607 patent. A187-89. Nevertheless, the ALJ ruled that all asserted claims were anticipated by U.S. Patent No. 7,372,455 to Perski et al. (“Perski”). A182-86; *see* A16,601-36. Perski discloses a transparent touchscreen that uses mutual capacitance, but scans differently—and much more slowly—than the ’607 patent. It also uses a voltmeter rather than Apple’s innovative charge sensor. The ALJ found the differences irrelevant. *Id.* Finally, the ALJ rejected Apple’s argument that Perski was not prior art because it was filed the year after Apple’s invention. A181-82. He held that Perski could claim priority back to an earlier provisional application. A181.

With respect to the **’828 patent**, the ALJ found that it was valid, A179-81, 211-12, and that the iPhone practices it, A237-38. He held,

however, that Motorola was not infringing it. A244. Critical to that ruling was a claim construction—of “mathematically fitting an ellipse,” A645, col. 60:5-16, and similar phrases—that no party had proposed. A58-70.

The ITC opinion. The ITC reviewed only the ALJ’s finding that the asserted claims of the ’607 patent are obvious. A517. The ITC agreed with the ALJ that the invention was obvious in light of SmartSkin, but for “different reasons.” A523; *see also* A518 (“modified reasoning”). For example, the ITC “disagree[d] with the ALJ’s conclusion that Rekimoto ’033,” in addition to SmartSkin, “teaches the use of transparent electrodes.” A523. Moreover, the ITC held that SmartSkin provides the “reason to combine” the “use of transparent electrodes made of materials such as ITO with the mutual capacitance sensor for detecting multiple touches on the sensor surface disclosed in SmartSkin.” A522-23. The ITC also found that “one of ordinary skill” would have had a “reasonable expectation of success” in that combination. A523.

The ITC did “not review, and therefore d[id] not address, the [ALJ’s] findings concerning secondary considerations.” *Id.* The ITC

also did not review the ALJ's analysis of the Perski patent or the '828 claim construction ruling. These determinations therefore became effective by operation of law. *See* 19 C.F.R. § 210.42(h)(2).

SUMMARY OF THE ARGUMENT

I. On “the question of obviousness,” the Supreme Court’s “cases have set forth an expansive and flexible approach.” *KSR Int’l Co. v. Teleflex, Inc.*, 550 U.S. 398, 415 (2007). That flexible inquiry compels a finding of nonobviousness here. It was not possible to produce a “transparent” touch sensor that can “detect multiple touches or near touches that occur at a same time and at distinct locations”—as the claims require—without significant innovation. It is undisputed that at the moment Steve Jobs told his engineers that his highest priority was to invent a revolutionary new touchscreen, no technology on the market could do what he had in mind. Until Jobs issued his edict, there was no “motivation to combine” capacitive sensing with transparent screens. *Id.* at 418. Even after Apple defined the problem in a “new revelatory way,” *Mintz v. Dietz & Watson, Inc.*, 679 F.3d 1372, 1377 (Fed. Cir. 2012), Apple’s experienced and accomplished engineers explored various twists and turns before settling on the right path. The PTO was correct

in concluding (as Apple's team had) that "[n]one of the cited art teaches or suggests a touch panel comprising a transparent capacitive sensing medium" that provided full image multi-touch. A10,427.

Moreover, objective indicia can compel a finding of nonobviousness even where "standing alone, the prior art provides significant support for the ... contention that the ... patent would have been obvious." *Alco Standard Corp. v. Tennessee Valley Auth.*, 808 F.2d 1490, 1499-1500 (Fed. Cir. 1986). Rarely has a single invention garnered as much praise as Apple's touchscreen. And the decision by just about every major manufacturer of cellphones to "follow[] Apple's lead" and "us[e] transparent full-image, multitouch sensors based on mutual capacitance" confirms their view of the touchscreen's novelty and utility. A7390; see A7828.

In declaring the '607 patent invalid, the ITC made basic errors of patent law. Most fundamentally, the ITC would deny Apple a patent to an invention that is, by all reasonable accounts, a revolutionary invention that occurred only because Apple invested resources on the assumption that the patent system would live up to its constitutional promise. The ITC ignored Apple's technical innovations, such as

figuring out how to measure the subtle changes in capacitance that occurred on the transparent screen, and ignored the high level of skill deployed by Apple's engineers. Impermissibly relying on hindsight, the ITC declared the Apple sensor an obvious combination of familiar technologies even though both the prior art and the record of Apple's critical and commercial success demonstrates that the sensor was new. And the ITC paid no mind to the PTO's careful consideration of the relevant prior art, disregarding the presumption of validity and the particularly high burden of showing invalidity where, as here, the PTO specifically considered the prior art.

II. Anticipation requires strict identity, not mere similarity, between the prior art's disclosure and the claimed invention, and as a result anticipation cases are "quite rare." *Trintec Indus., Inc. v. Top-U.S.A. Corp.*, 295 F.3d 1292, 1296-97 (Fed. Cir. 2002). Perski's touchscreen was first disclosed in a patent application filed in January 2004, *after* Steve Hotelling and his colleagues conceived their innovative touchscreen and reduced it to practice. Moreover, the '607 patent claims define the invention by *both* how it is built *and* what it can do. The touchscreen disclosed in Perski is *built* somewhat similarly

but *operates* differently than the touchscreen in the '607 patent. The '607 patent describes and claims a *full image multi-touch* sensor while Perski does not. The '607 patent's touchscreen advances over Perski, just as it advances over the many touchscreens disclosed in the 300-plus prior art references considered by the PTO. The decision below rests on a reading of the '607 patent's claims that is contrary to the evidence about what multi-touch means to those skilled in the art.

III. Before the ALJ, “[t]he key dispute for the '828 Patent [wa]s whether ‘mathematically fitting an ellipse’ is limited to the methodology defined in the patent.” A59. Yet after agreeing with Apple that the “fitting terms” were not limited to that methodology, the ALJ then adopted a construction not proposed by any party: “Performing a mathematical process whereby an ellipse is actually fitted to the data consisting of one or more pixel groups and from that ellipse various parameters can be calculated.” A58-70. The ALJ’s circular construction obscures the claim’s meaning and defies the intrinsic evidence. Chief among its problems is that it separates calculating parameters from the ellipse fitting when *an ellipse is fitted by calculating parameters*.

Apple respectfully requests a remand directing the ALJ to assess infringement under the correct construction.

STANDARD OF REVIEW

This Court reviews the ITC's legal determinations without deference and reviews factual findings for substantial evidence. *Crocs, Inc. v. ITC*, 598 F.3d 1294, 1302 (Fed. Cir. 2010). Under the substantial evidence standard, “[a] reviewing court must consider the record as a whole, including that which fairly detracts from its weight, to determine whether there exists such relevant evidence as a reasonable mind might accept as adequate to support a conclusion.” *Nippon Steel Corp. v. United States*, 458 F.3d 1345, 1351 (Fed. Cir. 2006) (citations omitted).

Claim construction is a legal determination. *Sorenson v. ITC*, 427 F.3d 1375, 1378 (Fed. Cir. 2005). Obviousness is a question of law based on underlying factual inquiries. *Crocs*, 598 F.3d at 1308. Whether prior art anticipates a patent claim is a question of fact. *Vizio, Inc. v. ITC*, 605 F.3d 1330, 1342 (Fed. Cir. 2010).

ARGUMENT

I. THE ITC ERRED IN HOLDING THAT APPLE'S TRANSPARENT FULL IMAGE MULTI-TOUCH SENSOR WAS OBVIOUS

Apple invented a touchscreen that no one else had ever achieved. As described in the claims, Apple invented a “touch panel” that could “detect multiple touches ... at a same time.” A561, col. 21:35-41. The “touch panel” could accurately discern the “location of the touches,” even if they were “at distinct locations” anywhere on the screen. *Id.* What’s more, the “touch panel” was “transparent,” which means that it had to be see-through—i.e., that the user would not see a “quite visible” pattern of electrodes superimposed over the display. A557-58, col. 14:65-15:7. To achieve these results, Apple had to solve technological problems that no one before it had ever solved.

The factors that are relevant to obviousness under 35 U.S.C. § 103(a) lead inexorably to the conclusion that this invention was not obvious. *See infra* Point I.A. The ITC’s contrary conclusion was based on several legal errors that warrant reversal. *See infra* Point I.B.

A. Apple's Transparent Full Image Multi-Touch Sensor Is Exactly The Type Of Innovation The Patent System Is Meant To Foster

On “the question of obviousness,” the Supreme Court’s “cases have set forth an expansive and flexible approach.” *KSR*, 550 U.S. at 415.

The framework entails two categories of factors. One category frames an analysis of the prior art: “the scope and content of the prior art are to be determined; differences between the prior art and the claims at issue are to be ascertained; and the level of ordinary skill in the pertinent art resolved.” *Id.* (quoting *Graham v. John Deere Co.*, 383 U.S. 1, 17 (1966)). The other category, sometimes called “secondary considerations,” is an assortment of objective indicia of nonobviousness. *KSR*, 550 U.S. at 406. Among them are “commercial success, long felt but unsolved needs, failure of others, etc.,” any of which “give light to the circumstances surrounding the origin of the subject matter sought to be patented.” *Id.* (citation and internal quotation marks omitted).

We address the two sets of factors in turn.

1. The prior art factors strongly support the conclusion that the '607 patent was not obvious

Apple’s improvement on the prior art is evident from every relevant angle—from the very framing of the problem to be solved and

**Confidential
Material Omitted**

the motivation to combine and improve technologies, to the various design choices the team had to make along the way, to the ingenuity with which they solved technological problems that no one else had ever solved.

To start, it is undisputed that at the moment Steve Jobs told his engineers that his highest priority was to invent a revolutionary new touchscreen—one that satisfied all the claimed criteria described immediately above—no technology on the market could do what he had in mind. *See supra* at 7. More to the point, no one had articulated a meaningful plan to do so. But Apple surveyed existing user interfaces and found them unsuitable. *See supra* at 8, 13-15. Only Apple envisioned a future user experience [REDACTED]

[REDACTED] A8384-89, 7379, 7390,15,431. Thus, a significant part of Apple’s “inventive contribution lies in defining the problem in a new revelatory way.” *Mintz*, 679 F.3d at 1377.

Until Jobs issued his edict, there was no “motivation to combine” capacitive sensing with transparent screens. *KSR*, 550 U.S. at 418. Unlike in *KSR*, there was no “exist[ing] marketplace that created a

**Confidential
Material Omitted**

strong incentive” to combine those elements. *Id.* at 424. “Technological developments” certainly had not “made it clear” that this new approach “would become standard.” *Id.* Apple created the marketplace and defined the *new* standard. As this Court has held, that inventive contribution, alone, would defeat an obviousness challenge even if an artisan would have been “virtually certain” to have figured out how to achieve Apple’s vision once he heard it and concluded it was worth pursuing. *Mintz*, 679 F.3d at 1377.

But, in fact, Apple’s ultimate success in achieving that vision was far from certain, even after Apple defined the problem in a “new revelatory way.” *Id.* One skilled in the art would have had numerous design decisions to make and obstacles to overcome. As detailed above, the artisan would have had to choose which among at least *five* types of touchscreen technologies to build upon, all of which Apple had studied and considered to be [REDACTED]

[REDACTED] A15,733; *see supra* at 8. Resistive, for example, was probably not the right choice, as Motorola discovered to its dismay. A7496. Or the artisan would have had to decide whether to try to devise a different technology entirely. *Ex ante*, there was no way to be sure which design

**Confidential
Material Omitted**

path would succeed. [REDACTED]

A15,431— [REDACTED] But, as Motorola learned from its ill-fated focus on a resistive technology— [REDACTED]

[REDACTED] A7496—that choice could not be taken for granted.

The twists and turns that Apple’s inventive process took before the optimum solution emerged further underscores that the expectation of success was fairly slim. *See Rolls-Royce, PLC v. United Techs. Corp.*, 603 F.3d 1325, 1339 (Fed. Cir. 2010) (“The important question is whether the invention is an ‘identified, predictable solution’ and an ‘anticipated success.’”) (citation omitted). Hotelling correctly predicted that the team would [REDACTED]

[REDACTED] A15,431 (emphasis added). Particularly relevant here was the team’s detour through a less fruitful form of capacitance sensing, [REDACTED]

[REDACTED] A16,145. [REDACTED]

[REDACTED]

**Confidential
Material Omitted**

[REDACTED]

[REDACTED] A14,335.

All this was especially telling in light of the Apple team's expertise. They were far more experienced and accomplished than the hypothetical engineer "of ordinary skill in the art," which the ITC defined as one who "would have a bachelor's degree in electrical engineering, physics, computer engineering, or a related field and [two to three] years of work experience with input devices." A522 (quoting ALJ) (alterations in original). If a technique was obvious to one skilled in the art, it should have been obvious to these considerably more experienced and proven innovators. *See Innovention Toys, LLC v. MGA Entm't, Inc.*, 637 F.3d 1314, 1323 (Fed. Cir. 2011) ("fewer inventions are obvious to a person with a lower level of skill than to one with a higher level of skill").

In view of the prior art, the PTO was correct in concluding (as Apple's team had) that "[n]one of the cited art teaches or suggests a touch panel having a transparent capacitive sensing medium" that provided full image multi-touch. A10,140, *see also* A9943-44. That was certainly true of Sony's SmartSkin, which the examiner twice analyzed.

A8937-44, 9268-75, *see also* A9938, 9961. SmartSkin technology was impressive, but did not solve Apple's puzzle: Copper wires are not invisible and SmartSkin was thus necessarily opaque. Sony's objective was the opposite of Apple's. Whereas Sony aspired to "extend[] [the] computerized workspace *beyond* the computer screen" by "turn[ing] *real-world surfaces, such as tabletops or walls*, into interactive surfaces," A13,597 (emphasis added), Apple was zeroing in directly on the computer screen in the hopes of making *it* the interactive surface, obviating any need for additional surface area for built-in touchscreens (e.g., trackpads) or external devices (e.g., a mouse, a joystick, a tabletop, or a wall).

Sony itself underscored the point when it mused about one day, in the "Future," adapting SmartSkin technology to a transparent surface just as it dreamed about some day applying it to an empathetic robot-pet. A13,603. Sony never studied how to achieve that goal. Thus, as the ALJ held, the "Future Work" section of the article "indicates" that use of transparent electrodes "likely was not contemplated" by Sony because "it would seem more likely that this would be entitled 'alternatives' or 'other embodiments' or some similar language." A188.

That should have been the end of the inquiry. As is evident from all the work the Apple team had to do to adapt mutual capacitance to ITO, it was not as simple as substituting “ITO” for “copper” wherever the SmartSkin design spec calls for “copper wire.” SmartSkin did not teach how to overcome the thorny problems that arose from the fact that ITO’s resistivity is at least 100 times greater than copper wire, thereby eliminating a voltmeter as an option to measure capacitance as SmartSkin did. And without a solution to that problem, a “transparent” “touch panel” would have been incapable of “detect[ing] multiple touches ... at a same time.” A561, col. 21:35-41. (Apple’s solution: Count electrons rather than measuring voltage. *See supra* at 18-19.) Nor did Sony teach how to make a display that a user could see through multiple layers of ITO without the distracting grid of ITO strips. And without a solution to that problem, the touchscreen would not be “transparent.” A557-58, col. 14:66-15:7; A561, col. 21:35-41. (Apple’s solution: Caulk the gaps with non-conducting ITO, among other things. *See supra* at 12-13, 19.)

To the contrary, as is true of other prior art references that this Court has found insufficient to support an obviousness finding,

SmartSkin did not even give “general guidance” on how to construct a transparent multi-touch sensor. *In re Roemer*, 258 F.3d 1303, 1309-10 (Fed. Cir. 2001) (citation omitted). The article’s “assertion” that it might be possible—with more “[w]ork”—to design such a sensor using ITO “is not accompanied by any teaching of how to adopt” the disclosed opaque sensor for use with a transparent screen displaying a graphical user interface. *Id.* at 1309. The SmartSkin article “does not teach or suggest how to specially design” a transparent multi-touch sensor that would work with ITO “nor does it [even] suggest the need” to alter the structure of the disclosed sensor in any way to accommodate the differences in electrical properties between copper and ITO. *Id.*

Apple—not Sony—invented all that. And it did so through the very sort of inventiveness that is synonymous with the Apple brand and that the patent system is supposed to encourage. Did Apple draw inspiration from SmartSkin? Of course. A16,145. “[I]nventions in most, if not all, instances rely upon building blocks long since uncovered, and claimed discoveries almost of necessity will be combinations of what, in some sense, is already known.” *KSR*, 550 U.S. at 418-19. If an invention is invalid merely because it builds upon

publicly available works, the PTO could just shutter its operations and deny every patent.

2. Objective indications reinforce the conclusion the '607 patent was not obvious

Objective indicia can compel a finding of nonobviousness even where “standing alone, the prior art provides significant support for the ... contention that the ... patent would have been obvious.” *Alco Standard*, 808 F.2d at 1499-1500. If ever there were a case for applying that principle, this is it. Three of the most significant criteria—praise, imitation, and commercial success—compel a finding of nonobviousness.

First, “praise in the industry that specifically relate[s] to features of the patented invention ... ‘indicat[es] that the invention was not obvious.’” *Power-One, Inc. v. Artesyn Techs., Inc.*, 599 F.3d 1342, 1352 (Fed. Cir. 2010) (quoting *Allen Archery, Inc. v. Browning Mfg. Co.*, 819 F.2d 1087, 1092 (Fed. Cir. 1987)). Rarely, has a single invention garnered as much praise as Apple’s touchscreen—from the commentator who lauded “Apple’s Magic Touch Screen,” A7826-27, to *Time* naming the iPhone the “invention of the year,” A7483, and marveling about the touchscreen’s “powerful illusion that you’re physically handling data with your fingers,” A7490, to the AT&T

**Confidential
Material Omitted**

executive who deemed the iPhone “the best device I have ever seen,” based in part on its “brilliant screen,” A8259.

Second, “imitation of” an invention is a “concession to its advance beyond the prior art and of its novelty and utility.” *Diamond Rubber Co. v. Consolidated Rubber Tire Co.*, 220 U.S. 428, 441 (1911); *see also Crocs*, 598 F.3d at 1311 (reversing the ITC’s holding of obviousness, noting that “[c]opying may indeed be another form of flattering praise for inventive features”). The decision by just about every major manufacturer of cellphones to “follow[] Apple’s lead” and “us[e] transparent full image, multitouch sensors based on mutual capacitance” confirms their view of the touchscreen’s novelty and utility. A7390; *see* A7828.

Especially probative in this regard was [REDACTED]

[REDACTED] A7537, [REDACTED]

[REDACTED] A7511.

See supra at 25-27; *Crocs*, 598 F.3d at 1311. This is a classic example of an accused infringer’s “redesign process [being] documented in the record in internal emails from [the accused infringer’s] engineers discussing [the patent owner’s] approach [and] identifying weaknesses

**Confidential
Material Omitted**

in [the accused infringer's] approach,” and the accused infringer “ultimately deciding to switch to the [patent owner's] system.” *Akamai Techs., Inc. v. Cable & Wireless Internet Servs., Inc.*, 344 F.3d 1186, 1196-97 (Fed. Cir. 2003). If the touchscreen was so obvious, Motorola's acclaimed engineers would have solved the technological problems itself, [REDACTED]

■ A7498.

Third, “[i]f in fact a product attains a high degree of commercial success, there is a basis for inferring that such attempts have been made and have failed.” Richard L. Robbins, *Subtests of “Nonobviousness”: A Nontechnical Approach to Patent Validity*, 112 U. Pa. L. Rev. 1169, 1175 (1964) (cited in *Graham*, 383 U.S. at 18). By this metric, Apple's touchscreen is about as nonobvious as can be, with worldwide revenues from the iPhone and related products almost doubling year on year, from \$7 billion in 2008, to \$13 billion in 2009, to \$25 billion in 2010, to \$47 billion in 2011, A14,184, 2011 Apple 10-K at 33, resulting in a 19% market share in 2011. See Whitney, *supra* at 24 n.4.

* * *

With all these indications of nonobviousness, this case bears a striking resemblance to *Diamond Rubber*, 220 U.S. at 428, where the Supreme Court long ago rejected an obviousness argument. Like the invention at issue there, Apple’s touchscreen “was not the result of chance or the haphazard selection of parts; [its] success could only have been achieved by a careful study of the scientific and mechanical problems necessary to overcome the defects which rendered the then-existing [sensors] ineffective and useless.” *Id.* at 443-44. Like the invention in *Diamond Rubber*, the touchscreen in phones “immediately established and has ever since maintained its supremacy over all other [sensors], and has been commercially successful while [all other designs] have been failures.” *Id.* at 441. The “extensive use” the iPhone’s touchscreen has attained “could only have been the result of its essential excellence, indeed, its pronounced superiority over all other forms.” *Id.* at 442. Moreover, the touchscreen “possess[es] such amount of change from the prior art to have received the approval of the Patent Office, and is entitled to the presumption of invention which attaches to a patent.” *Id.* at 434.

B. The ITC’s Rationale For Finding Apple’s Touchscreen Obvious Was Legally Flawed

The ITC overlooked or discounted all of this evidence of true innovation to hold that “the use of transparent ITO in combination with the mesh grid touch sensor of SmartSkin is just the type of ‘combination of familiar elements’” that was obvious under Supreme Court precedent. A525 (quoting *KSR*, 550 U.S. at 416). The ITC would not have reached this conclusion but for several fundamental mistakes of patent law.

Using the invention to define the problem. This Court has repeatedly warned against the temptation to infect the obviousness analysis with various “form[s] of prohibited reliance on hindsight.” *Mintz*, 679 F.3d at 1377. The ITC did just that in the passage quoted immediately above by using “the invention to define the problem that the invention solves.” *Id.* The ITC did not so much as acknowledge the point (discussed above) that Apple’s “inventive contribution” lay, in part, in defining the problem “in a new revelatory way.” *Id.* Instead, it collapsed the entire inventive process, entailing multiple layers of complexity and design choice, into the ultimate technical solution disclosed in the patent.

This myopic focus on how to make mutual capacitance work on a transparent surface is the analytical equivalent of reducing Thomas Edison's light bulb down to the question, "If I'm going to make an incandescent bulb using an especially strong vacuum, a high-resistance lamp, and a carbon filament, how thick should I make the carbon filament?"

Undervaluing ingenuity. Even accepting the ITC's focus on the narrow technical problem solved—how to replace the copper wires in SmartSkin with transparent ITO—the ITC erroneously undervalued Apple's ingenuity. The ALJ did not address Apple's technical innovations. Announcing "different reasons" than the ALJ, A523, the ITC dismissed the technical challenge of measuring capacitance changes in a material as non-conductive as ITO. It also entirely ignored the ingenuity behind hiding the pattern of ITO circuitry, which, as the specification indicated, would otherwise be "quite visible" (and hence not transparent) to the user. A557-58, col. 14:65-15:7; *see supra* at 12-13, 19.

The ITC made passing reference only to the former innovation, not the latter. All it said was that "Apple's arguments concerning the

difficulty of implementing a transparent ITO sensor with a voltage-sensing system are irrelevant,” because “the claimed invention is not drawn to a particular sensing arrangement.” A528. That is incorrect. While the claims do not explicitly mention “charge counting,” they *do* explicitly require a transparent sensor to meet the multi-touch limitations, and “the way you can get there in the ’607 [patent] is with the charge counter.” A31,784. Apple’s expert testified, at length and without contradiction, that simply swapping ITO for copper in SmartSkin would not have created the claimed invention. The multi-touch limitations, he explained, would not be met because SmartSkin’s voltage-sensing circuitry could not detect drastically weaker signals. A31,770-85. The ’607 patent solves this problem by employing charge-counting sensing circuitry, which is described in every embodiment. A31,773; *see also* A545, figs. 12, 13; A559, col. 17:12-61.

In the end, the ITC fell into another trap the Supreme Court warned of long ago: “[E]xpert witnesses may be brought forward to show that the new thing which seemed to have eluded the search of the world was always ready at hand and easy to be seen by a merely skillful artisan.” *Diamond Rubber*, 220 U.S. at 435. That is all Motorola’s

expert did with his facile pronouncement that “to a person who understands [the SmartSkin] paper, figure 2 tells you exactly how they would do it with a transparent sensor.” A31,451; *see* A525. That testimony is conclusory and demonstrably wrong. Nowhere in the SmartSkin article is there any hint on how to overcome the technical problems Apple solved, much less direction on “exactly how” to do it.

Objective indicia of obviousness. The ALJ’s analysis of the objective indications of obviousness (which the ITC declined to “review,” A523) mentioned only one factor—commercial success—and ignored the ample evidence of the other factors. A216-17. That, alone, was error. But even its analysis of that one factor was doubly flawed.

First, the ALJ violated this Court’s repeated direction that a fact finder must “consider the objective evidence *before* reaching an obviousness determination” and “may not defer examination of the objective considerations until after [it] makes an obviousness finding.” *In re Cyclobenzaprine Hydrochloride Extended-Release Capsule Patent Litig.*, 676 F.3d 1063, 1075, 1079 (Fed. Cir. 2012) (emphasis added); *see also Mintz*, 679 F.3d at 1379 (holding that district court erred in “believ[ing] that it need not fully weigh objective indicia evidence”);

Hybritech Inc. v. Monoclonal Antibodies, Inc., 802 F.2d 1367, 1380 (Fed. Cir. 1986).

The ALJ did the opposite here. He first concluded, based on the prior art factors, that Apple’s solution was obvious. A216. Only then did he ask, in a brief afterthought, whether the one objective factor he considered could “overcome the strong showing of obviousness” based on prior art. A216-17. Approaching the inquiry this way negates the critical role the Supreme Court assigned to objective factors: preventing hindsight bias in the examination of prior art. *See In re Cyclobenzaprine Hydrochloride Litig.*, 676 F.3d at 1079 (citing *Graham*, 383 U.S. at 36). Objective evidence “constitutes *independent* evidence of nonobviousness” and “is not just a cumulative or confirmatory part of the obviousness calculus.” *Ortho-McNeil Pharm., Inc. v. Mylan Labs., Inc.*, 520 F.3d 1358, 1365 (Fed. Cir. 2008) (emphasis added).

Second, the ALJ also erred in holding that “the required nexus between the commercial success of the iPhone 4 and the specific features covered by the ’607 patent does not exist” because “the evidence shows that the iPhone’s success stems from other product characteristics.” A217. Reversing the ITC just two years ago, this

Court held that where, as here, a product is commercially successful and practices a patent, these two facts, alone, establish a prima facie case of nexus between the patent and the commercial success. *Crocs*, 598 F.3d at 1310-11. Motorola could not overcome that prima facie case merely by noting that “many market forces unrelated to the inventiveness of [a] patent may influence commercial success.” *Id.* at 1311. It was required to “make a *convincing case* that those market forces indeed were the likely cause of success.” *Id.* (emphasis added).

Motorola did not come forward with any competent evidence, much less “convincing” evidence. It adduced nothing but its technical expert’s unsupported assertion that Apple’s products “have been successful primarily because of other ... characteristics” unrelated to the touchscreen. A18,188 (cited by ALJ at A217). Since this witness was an engineer with no expertise in marketing or consumer behavior, his opinion lacked any foundation. But even if he was qualified to testify on the subject, he conceded that his opinion was baseless: He had “not done any surveys about why consumers buy the iPhone 4” and had no evidence as to “why people are buying the iPhone 4 in droves.” A31,486.

Failure to grant the PTO any deference. Even in the usual case, the ITC would have to presume the '607 patent valid, and would not be able to declare it invalid without holding Motorola to the especially high burden of proving obviousness by clear and convincing evidence. *Microsoft Corp. v. i4i Ltd. P'ship*, 131 S. Ct. 2238, 2246 (2011). But the threshold is even higher than usual here. The PTO took six years to study the relevant prior art and technology, including SmartSkin. So Motorola had the "added burden of overcoming the deference that is due" to the PTO where, as here, the relevant prior art plainly was disclosed to and considered by the examiner. *McGinley v. Franklin Sports, Inc.*, 262 F.3d 1339, 1353 (Fed. Cir. 2001). Yet the ITC failed even to mention that the art at issue in this case was before the PTO.

* * *

"The inherent problem" that the obviousness requirement addresses is "weeding out those inventions which would not be disclosed or devised but for the inducement of a patent." *Graham*, 383 U.S. at 11. An inventor who "has added a new and valuable article to the world's utilities ... is entitled to the rank and protection of an inventor."

Diamond Rubber, 220 U.S. at 435. Apple did just that—in the most spectacular way. Apple did so, as it has done it time and again, by applying its business strategy of designing and developing “nearly the entire solution for its products, including the hardware, operating system, numerous software applications, and related services.”

A14,162. The only way Apple can maintain this strategy—and continue to innovate—is by “mak[ing] significant investments in research and development.” *Id.* But for every innovation that does work, countless others fail. If this Court wishes to encourage this sort of innovation, it must grant them patent protection when they pan out. The Patent Act will not “promote ... Progress,” U.S. Const. art. 1, § 8, cl. 8, if it is interpreted to invalidate patents like this one. The ITC must be reversed.

II. THE ALJ ERRED IN HOLDING THAT THE PERSKI PATENT ANTICIPATED APPLE’S TRANSPARENT FULL IMAGE MULTI-TOUCH SENSOR

The ITC also erred in leaving intact the ALJ’s conclusion that the ’607 patent was invalid as anticipated by the Perski ’455 patent. First, Perski came after the ’607 patent’s invention, and the earlier application that Motorola invoked to relate the Perski patent back to an

earlier date omits disclosures critical to Motorola’s anticipation argument. *See infra* Point II.B. Second, the Perski invention did not satisfy every claim limitation in the ’607 patent. *See infra* Point II.A. Because the first argument is easier to understand in light of the claim limitations, we begin with the second.

A. Motorola Did Not Sustain Its Burden Of Proving That Perski’s Sensor Was Sufficiently Fast And Accurate For Full Image Multi-Touch

It was improper for the ITC to find anticipation unless Motorola presented clear and convincing evidence that “the invention was described in a patent granted on an application for patent by another filed in the United States before the invention thereof by the applicant for patent.” 35 U.S.C. § 102(e); *see Microsoft*, 131 S. Ct. at 2242. It is “quite rare” for this Court to find a patent invalid on this ground because anticipation requires “strict identity” between the prior art’s disclosure and the invention. *Trintec Indus.*, 295 F.3d at 1296-97.

Perski does not teach a full image multi-touch sensor, much less pose the solutions necessary to make it a reality. A16,604, col. 1:14-2:60; A31,794. Perski was explicit about its intention to “teach[]” “a *single touchscreen* that can detect either *a finger* or *a special stylus*,”

A18,160-62 (emphasis added), to allow “natural and intuitive operation of an ‘on-screen-keyboard,’” which necessarily involves one touch at a time. A16,607, col. 8:33-37; *see* A16,604, col. 1:14-2:60; A16,607, col. 8:9-13; A31,794. Because that was all Perski was trying to address, it is unsurprising that the patent describes a touchscreen that differs from the ’607 patent’s claimed invention in two crucial respects: the *speed* and the *accuracy* of multi-touch detection. The ’607 patent’s touchscreen advances over Perski, just as it advances over the many touchscreens disclosed in the 300-plus prior art references considered by the PTO.

1. Motorola presented no evidence that Perski’s disclosed scanning algorithm can detect touches “at the same time as viewed by a user”

As we explain more fully below, the undisputed evidence was that Perski scanned for touches much more slowly than the ’607 patent—and not nearly fast enough to enable multi-touch. But the ALJ ignored all this evidence on the ground that “the speed at which multiple touches [are] detected [is] irrelevant” to the claims. A186. That was a clear error of law.

The ’607 patent defines the invention by *both* how it is built *and*

**Confidential
Material Omitted**

what it can do. The plain language of the relevant claims requires a touchscreen that is “configured to detect multiple touches ... that occur *at a same time.*” A561, col. 21:35-56 (claim 1) (emphasis added); *see also* A561, col. 22:23-55 (claim 10 requires a touchscreen “capable of recognizing multiple touch events that occur at different locations on the touch panel at a same time”). The specification confirms that these limitations are not satisfied unless all nodes are sensed at “about the same time (as viewed by a user) so as to provide multipoint sensing.” A559, col. 17:33-36; A7167, 7195-96. If you have to leave your fingers fixed on the same spots on a touchscreen for a long while before the screen recognizes them as distinct touches, the technology is not “multi-touch.” It is press-and-freeze, which is of limited value.

Both Apple and Motorola agreed that these “at the same time” limitations required the claimed touchscreen to detect multiple touches quickly. Indeed, Motorola insisted that “at the same time” allowed for no delay at all—perceptible or not. A19,316-19, 19,333, 19,336-37; *see also* A1008-09, 1013, 1032-35. Motorola’s expert argued that

_____ A19,316-19; *see* A19,336-37.

**Confidential
Material Omitted**

The extrinsic evidence supported Apple’s and Motorola’s view. [REDACTED]

[REDACTED]

[REDACTED]

[REDACTED] A7510. [REDACTED]

[REDACTED] *Id.* [REDACTED]

[REDACTED]

[REDACTED] *Id.*

Despite all this, the ALJ held that speed was irrelevant. That would mean that a touchscreen that required a user to hold his fingers still for minutes, or even hours, to register as multiple touches would still qualify as a device that detects touches that occur “at a same time.” That is obviously wrong. And the ALJ himself seemed to acknowledge as much elsewhere: He looked to scanning speed in Motorola’s products [REDACTED] as evidence that they infringed the “at the same time” limitations. A149-50.

Had the ALJ applied the claims correctly in deciding anticipation, he would have had to conclude that Motorola failed to sustain its burden of proving that the Perski sensor was fast enough to satisfy this “at the same time” limitation. The touchscreen disclosed in Perski is

built somewhat similarly but *operates* differently than the touchscreen claimed in the '607 patent. The only evidence in the record supports Apple's position that the Perski sensor is too slow to detect multiple touches "at the same time."

Perski itself explains why: Perski requires many more steps in detecting a touch, and those extra steps drastically slow down the sensor. Essentially, in an array of rows and columns of ITO, Perski will not detect multiple touches unless and until it scans each individual sensor sequentially, one at a time. A16,610, col. 14:20-31. For m rows and n columns, that is $n*m$ scanning steps. A16,610, col. 14:31-35. And the specification states that the scan must "typically" be performed twice, for $n*m*2$ steps. A16,610, col. 14:35-37. In contrast, the invention described in the '607 patent achieves the same result by scanning *all the rows at once*, while measuring each column sequentially, which means just m steps. It is like the difference between one farmhand scanning the whole grid, plant by plant, versus 50 farmhands racing down 50 rows of tomato plants scanning for ripe tomatoes.

**Confidential
Material Omitted**

Put another way, consider an array of the sort described in the '607 patent—with 50 sensing lines (rows) and 38 driving lines (columns). A557, col. 14:57-59. To scan each individual sensor twice, Perski would require 3,800 scanning steps (50*38*2). See A16,610, col. 14:20-24, col. 14:31-35, A31,790-92. In contrast, the '607 patent can do the same job just by scanning all 50 rows at once for each drive pulse—**or 100 times faster**. Perski *itself* cites this as the “disadvantage” of its detection method. A16,610, col. 14:31-56.

Apple’s expert unequivocally testified that the sheer number of scanning steps described in Perski made the device so slow that it could not detect multiple touches at the same time. A31,743, 31,749-50, 31,790-94, 31,812-24. [REDACTED]

[REDACTED]

[REDACTED] A14,574, 14,577, [REDACTED]

[REDACTED]

[REDACTED] A14,574;

see A7202-03, 7208-10. In other words, scanning one sensor at a time does not disclose or enable multi-touch.

The ALJ turned Motorola's burden upside down when he reasoned that "[t]here is nothing in Perski '455 to indicate that the method disclosed therein *would not* be able to detect touches 'at the same time' as viewed by a user." A186 (emphasis added). The ALJ seemed to forget that he could not find that '607 patent anticipated without clear and convincing evidence that Perski *could* meet the '607 patent's claim limitations. *See Microsoft*, 131 S. Ct. at 2242. This was Motorola's burden, not Apple's. And the ITC did nothing to acknowledge or correct the ALJ's plain burden-shifting error.

The simple fact is that despite its burden of proof, Motorola presented *no evidence* whatsoever that the Perski sensor could detect multiple touches quickly enough to satisfy the multi-touch limitations. This basic failure of proof by Motorola precludes a finding of anticipation. Motorola simply repeated its mantra that Perski and the '607 patent were "similar" or "virtually identical," which the ALJ accepted without acknowledging the actual, unrebutted evidence (discussed above) of how the scanning algorithms in Perski and the '607 patent differed. *See* A183-85.

2. Motorola presented no evidence that Perski's disclosed method can accurately detect multiple touches

Motorola's expert agreed that "[t]he '607 patent ... requires detecting two or more touches anywhere on the touch panel Anything else would be inconsistent with the teachings of the patent." A19,317-19. But Motorola presented no evidence that Perski is capable of sensing simultaneous touches anywhere on the touch panel. The only evidence on the record is that Perski does not, for its goal was to improve a "single touch[]" device. A18,161-62. All Perski says on the subject is: "When an output signal is detected on more than [sic] one conductor that means more than one finger touch is present." A16,610, col. 14:38-40. This way of interpreting signals will inevitably result in inaccurate simultaneous multi-touch detection. For example, as Apple's expert testified, Perski would not accurately report the number of touches in any scenario where "a single large touch could cause an output signal to be detected on more than one conductor line," because it would report that one touch as multiple touches. A8748-51, 31,753-54.

The ALJ mistakenly stated that “Apple concedes that Perski ’455 does, in fact, disclose multitouch detection.” A186 (citing A31,757-58). The cited testimony came moments after the above-quoted passage in which Apple’s expert said exactly the opposite. A31,753-54. In the passage the ALJ cited, the expert merely agreed that Perski’s detection method would not suffer from one specific sort of problem called “shadowing.” A31,757-58. But as Apple’s expert explained, “shadowing” is just one of several types of multi-touch detection problems. A7164. He cited a variety of “*other problems that prevent the accurate detection of multiple touches.*” *Id.* (emphasis added).

B. Perski Is Not Prior Art To The ’607 Patent

Even if Perski did describe the ’607 patent’s inventions, the ALJ still erred in finding that Perski anticipated the ’607 patent. Apple conceived of the ’607 patent’s inventions and reduced them to practice in 2003. *See supra* at 6-19; A8728-8734. That was *before* Perski filed his patent application in 2004, which means that Perski could not have anticipated the ’607 patent. The ALJ erred in concluding that Perski could claim priority back to an earlier provisional application (the “’808 application”) that predated the ’607 patent.

The ALJ was required to reject Motorola’s backdating effort unless it presented clear and convincing evidence “that the provisional application ... provide[d] written description support for the claimed [Perski] invention” (and in turn the ’607 patent claims that Perski allegedly anticipates). *In re Giacomini*, 612 F.3d 1380, 1383 (Fed Cir. 2010); see *Mahurkar v. C.R. Bard, Inc.*, 79 F.3d 1572, 1576 (Fed. Cir. 1996) (burden applies to “all issues relating to the status of [Perski] as prior art”).

The ’808 application does not provide written description support for Perski in two respects. First, the provisional application does not disclose any way of determining whether multiple fingers touch the screen. The critical sentence in Perski that Motorola and the ALJ seized upon in reasoning that Perski satisfied the multi-touch limitation—*the only sentence on the subject in Perski*—was this: “When an output signal is detected on more than one conductor that means more than one finger touch is present” such that the touch panel “enables the detection of multiple finger touches.” A184-85 (citing 16,610, col. 14:20-43). No such proposition appears anywhere in the ’808 application. A16,147-55; see also A31,796-97; A6856-57 (redline

indicating additions and deletions between the '808 application and Perski); A8752-53. This disclosure makes its first appearance in the 2004 Perski application. A16,412. Without this disclosure, Motorola has not cited a shred of support for the argument that the provisional application discloses how to determine whether multiple fingers touch the screen. *See* A16,147-55, 16,610, col. 13:26-14:59; A18,341-42.

Second, in attempting to show that the '808 application provides written description support for the “output this information to a host device to form a pixilated image” element of claim 10, Motorola entirely relied on another provisional application, Morag '662. Specifically, Motorola relied on that application's descriptions of a “Front End” and “Digital Unit.” A18,416-17, 18,432-33, 18,460-74, 18,475-80. But the '808 application does not incorporate by reference that particular material from Morag '662. Motorola's expert acknowledged that only “certain portions” of Morag '662 are incorporated by reference in the '808 application, namely the transparent sensor's description—not the “Front End” and “Digital Unit” descriptions. A18,412-13; *see* A16,577-81, fig. 1. When the incorporation statement is limited in this way, it cannot be read to incorporate “separate and distinct” elements of the

referenced document. *Zenon Env'tl, Inc. v. U.S. Filter Corp.*, 506 F.3d 1370, 1380 (Fed. Cir. 2007).

Because Perski is not entitled to the '808 application's priority date, it is not prior art to the '607 patent. For this reason, alone, the ALJ's anticipation ruling must be reversed.

III. THE COMMISSION BASED ITS FINDING THAT THE '828 PATENT WAS NOT INFRINGED ON THE ALJ'S INCORRECT CONSTRUCTION OF THE "MATHEMATICALLY FITTING AN ELLIPSE" TERM IN THE '828 PATENT

By acquiring the '828 patent, entitled "Ellipse Fitting for Multi-Touch Surfaces," Apple was able to combine its innovative hardware with cutting-edge software that made multi-touch even more precise and seamless. A7403-04. The relevant claims focus on a way of tracking multiple simultaneous finger and palm contacts on or near a touch surface. The program begins by taking an image representing a scan of electrodes (a "proximity image") and arranging it into groups (called "pixel groups" or "electrode groups"). A645, col. 60:5-16 (claim 1); A7095-96. Figure 13 below is a sample proximity image:

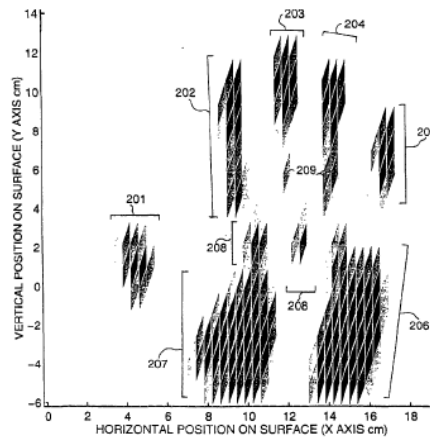

FIG. 13

A583, fig. 13. The software then “mathematically fit[s]” one or more pixel groups into an ellipse. A588, fig. 18.

Claim 1 describes:

A method of processing input from a touch-sensitive surface, the method comprising:

receiving at least one proximity image representing a scan of a plurality of electrodes of the touch-sensitive surface;

segmenting each proximity image into one or more pixel groups that indicate significant proximity, each pixel group representing proximity of a distinguishable hand part or other touch object on or near the touch-sensitive surface; and

mathematically fitting an ellipse to at least one of the pixel groups.

A645, col. 60:5-16 (emphasis added). Claim 10 uses the nearly identical term, “mathematically fit an ellipse,” A645, col. 60:49-67, and Claim 24

uses, “fitting an ellipse,” A646, col. 62:4-13. Motorola’s entire non-infringement position revolved around this claim limitation.

The disputed claim limitation applies principles of data fitting. Data fitting is about finding a geometric shape—here, an ellipse—that approximates the shape of a cluster of data points. A6715. “An ellipse can be fully described” in mathematical terms with five numbers, indicated the graphic below: “(1) X position of centroid [the center point of the shape]; (2) Y position of centroid; (3) minor axis length; (4) major axis length; and (5) orientation angle.” A4495; *see* A18,058.

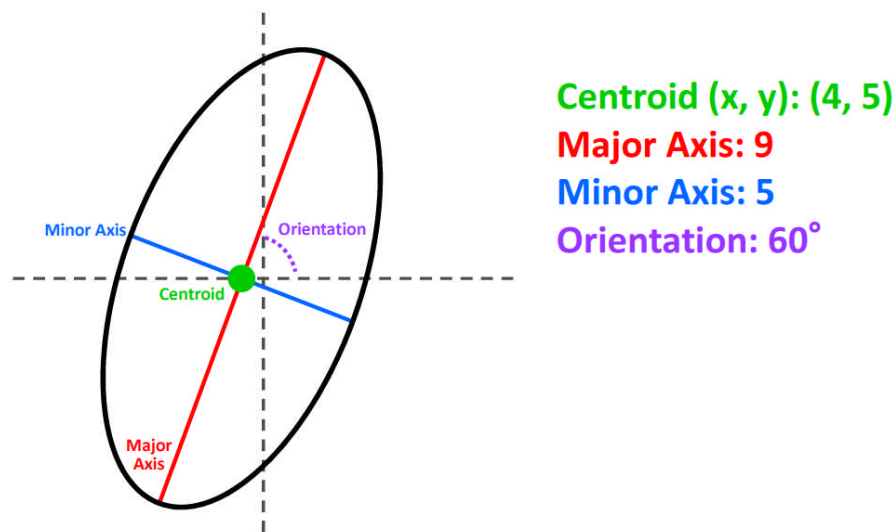

A6716.

The most reliable way to fit a cluster of data points to a shape is “mathematical fitting,” which entails applying a series of mathematical

formulas directly to the data points. Before the advent of high-speed computers, performing these calculations on paper was arduous. So engineers would routinely take a shortcut: The engineer could plot the data points on graph paper, eyeball the cluster, and actually draw a standard geometric shape that approximates the data. The draftsman could then take a ruler and measure the size, the x and y locations, and the exact contours of the approximated shape. A30,703-04.

The '828 patent invokes a far more reliable mathematical fitting, which is now much easier through modern computers. Mathematical fitting is not accomplished by drawing a shape (here, an ellipse) first. Rather, the software plugs data from the pixel group into a series of equations. A628, col. 25:54-26:56; A7116-17. The equations then yield numbers representing the parameters of an ellipse that approximates the shape of the pixel group. A7116-17, 18,062.

Both Apple and Motorola agreed that “mathematically fitting an ellipse,” as used in the relevant claims, means calculating the five parameters of a standard ellipse. *See, e.g.*, A4475 (“[t]he '828 patent refers to the mathematical modeling of pixel data resulting from touches by fingers and other hand parts as ‘ellipse fitting’”); *see also*

A7116, 7401, 8691-712, 18,057-58, 18,062, 18212-13, 30,071, 30,329-30, 30,366. That was the concept behind Apple’s proposed construction of “mathematically fitting an ellipse,” which was to “comput[e] numerical parameters that mathematically define an ellipse which approximates the shape of at least one of the pixel groups.” A3112-16.

Motorola did not dispute how mathematical fitting works, instead arguing only a much narrower point: that in this particular patent there is an additional, unstated limitation, requiring that any calculation of the ellipse parameters be performed using particular equations recited in the specification. A30,613-14 (Motorola’s counsel frames the difference between Apple’s and Motorola’s positions as “whether you need to include some specific procedure or whether you can use any mathematical procedure to compute the parameters”). Thus, the Apple-Motorola dispute was a classic claim construction question of the kind this Court has resolved many times: should a facially broad claim be limited in scope to cover only the preferred embodiment?

Instead of resolving that narrow dispute between the parties, the ALJ overrode the agreement between Apple and Motorola regarding the

meaning of “mathematically fitting an ellipse” and announced his own new construction. He construed the term to require a two-step process: “[1] performing a mathematical process where by an ellipse is *actually fitted* to the data consisting of one or more pixel groups and [2] *from that* ellipse various parameters can be calculated.” A70 (emphasis and bracketed numbers added). In this construction, ellipse parameters are calculated only *after* an ellipse has somehow been “actually fitted.”

The ALJ’s two-step construction betrays a fundamental misunderstanding about how a mathematical fitting process works and (more importantly) of what the ’828 patent says. The specification itself exposes the ALJ’s mistake in three ways. First, the preferred embodiment—which all parties agree practice the claims—fits an ellipse *by calculating the parameters of that ellipse*. A628, col. 25:54-26:67; A7401, 18,212-13, 30,318-20. The patent lists a series of equations that output a set of ellipse parameters. A628, col. 25:54-26:67. (These same equations are used to fit an ellipse in the iPhone. A237-38.) The ALJ’s construction has it backwards. In the ALJ’s view, it is as if the software were a human draftsman fitting an ellipse the old fashioned way—by actually drawing a shape with a pencil around data

points on graph paper. But, in fact, no ellipse is “actually fit” first before the parameters are calculated. There is no way to read this illustration—or any other sentence in the specification—and conclude that the invention requires the software to mathematically fit an ellipse *before* calculating ellipse parameters.

Second is the specification’s explanation of a flow chart (Figure 18) that tracks the steps of claim 1. A588, fig. 18; *see* A6144, 7095-96, 7116-17, 20,030-39, 30,070. The figure shows steps in boxes with verbs (e.g., “fit,” “combine”) and inputs/outputs of the steps in circles. A588, fig. 18; A627, col. 23:9-15, 23:20-23, 23:58-60; A628, col. 25:11-14; 25:54-56. For present purposes, the key step is step 272, toward the bottom of the chart, labeled “FIT ELLIPSES TO COMBINED GROUPS,” which corresponds to “mathematically fitting an ellipse” in the claims.

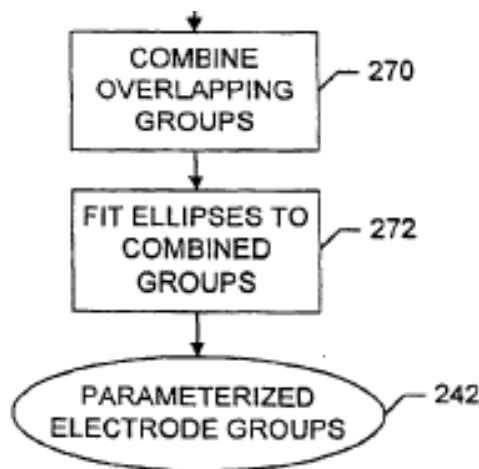

FIG. 18

A588, fig. 18 (cropped); A621, col. 11:55-56; *see* A6144, 7095-96, 7116-17, 30,070. The specification explains: “The last step 272 of the segmentation process is to extract shape, size, and position *parameters* from each electrode group.” A628, col. 25:54-56 (emphasis added). It further notes that, for “most [pixel] groups,” “their shape is well approximated by *ellipse parameters*.” A628, col. 26:17-18 (emphasis added); *see also* A586, fig. 16; A588, fig. 18; A625, col. 19:8-12. Likewise, “fit[ting] ellipses” results in “parameterized electrode groups” in Figure 18. A588, fig. 18. Nowhere does the flow chart or the specification suggest that the computer “actually” draws or fits an ellipse first and then measures the parameters from that ellipse. Of course, the specification’s express definition of mathematically fitting should control. *See, e.g., Sinorgchem Co., Shandong v. ITC*, 511 F.3d 1132, 1136 (Fed. Cir. 2007). But the ALJ did not even mention step 272.

Third, the ALJ’s construction also reads out of the patent an alternative way to perform step 272 described in the patent. A629, col. 27:1-8; A30,350-51; *see also* A7117-18 (testimony confirming that this section describes a second embodiment of the “fit ellipses” step). In the

second embodiment, like in many Motorola products, default values are used for some ellipse parameters. A629, col. 27:3-6. This second embodiment does not “actually” fit an ellipse before measuring ellipse parameters either.

Even the extrinsic evidence that the ALJ cited confirms the same point. For example, the ALJ cited a dictionary definition of “curve fitting” as “the empirical determination of a curve or function that *approximates a set of data.*” A69 (emphasis added). This definition does not require the drawing of a curve first, before calculating the parameters that “determin[e] a curve.”

The ALJ also found inventor testimony “informative.” A70. And it is—albeit in Apple’s favor. The inventor testified that “to fit an ellipse, as an example, to a collection of data points means that you want to *find the parameters* that describe that ellipse.” A69 (emphasis added). That is precisely our point. You manipulate the “collection of data points” to “find the parameters that describe that ellipse.” You do not draw the ellipse first, and then “find the parameters.”

In short, all the extrinsic evidence confirms that you do not need to do anything more than “mathematically fit” an ellipse than to

calculate ellipse parameters. In the words of Motorola's expert, the "five parameters are" all that is "required to *fully describe* an ellipse." A18,057, 18062 (emphasis added). Based on similar evidence, a district court in California recently agreed with Apple's construction, holding that "mathematically fitting an ellipse" ordinarily means calculating the parameters of an ellipse, and that the "fitting terms" should be given that ordinary meaning. *Apple Inc. v. Samsung Elecs. Co.*, No. 11-cv-01846, 2012 WL 1123752, at *19-20, 25 (N.D. Cal. Apr. 4, 2012).

Here, the ALJ rejected Apple's construction for two reasons. First, the ALJ held that Apple's construction was wrong because the parameters that define an ellipse (centroid position, axes lengths, and orientation) theoretically could define other shapes as well. A64. But the ALJ's logic overlooks a basic point of patent law: A claim is infringed if an ellipse is mathematically fitted; it is irrelevant that the same fitting process results in variables that could, in theory, *also* define other shapes. *See, e.g., Radio Steel & Mfg. Co. v. MTD Prods., Inc.*, 731 F.2d 840, 848 (Fed. Cir. 1984) ("[A]n accused device that contains the same feature as the patented device cannot escape infringement because in it that feature performs an additional function

**Confidential
Material Omitted**

it does not perform in the patented device.”). Indeed, even the ’828 patent’s preferred embodiment—which the ALJ and all parties agree “mathematically fit an ellipse”—merely computes variables (centroid position, axes lengths, orientation) that could define shapes other than an ellipse. A628, col. 25:65-26:67; A8691-92.

Second, the ALJ believed that Apple’s construction “would *read out* the requirement that an ‘ellipse’ be ‘fitted’ ‘mathematically’ to the pixel groups.” A63 (emphasis added). Not so. Apple’s construction contemplates “fitting” by specifically stating that the ellipse must “approximate the shape” of the pixel group. Apple’s construction also entails the “mathematical” limitation, because it requires “computing numerical parameters,” which is a mathematical operation.

* * *

The ALJ’s finding that Motorola did not infringe the ’828 patent flowed directly from his incorrect construction of “mathematically fitting an ellipse.” Apple will prevail under its construction. [REDACTED]

[REDACTED]

**Confidential
Material Omitted**

[Redacted]

[Redacted]

A6813, 13,706, 17,991, 19,289-90, 19,292, 30,741-43, 31,120-26. [Redacted]

[Redacted]

[Redacted]

[Redacted] A7135, 6162-65, 19,288-92,

30,710. Accordingly, this Court should reverse the ALJ’s conclusion that Motorola did not infringe the ’828 patent.⁵

CONCLUSION

For the foregoing reasons, the judgment of the ITC should be reversed and the case remanded.

⁵ This appeal focuses on the threshold legal issue of claim construction. On remand, and if necessary in any subsequent appeal, Apple will address both literal and doctrine of equivalents infringement under the correct construction, as well as the ALJ’s erroneous finding that prosecution history estoppel applies. *See* A145-47.

Dated: July 20, 2012

Respectfully submitted,

/s/ E. Joshua Rosenkranz

E. Joshua Rosenkranz

Orrick, Herrington & Sutcliffe LLP

51 West 52nd Street

New York, NY 10019

Attorney for Appellant

ADDENDUM

Notice Regarding Initial
Determination on Violation of
Section 337 and Recommended
Determination on Remedy and Bond,
Dated January 13, 2012

UNITED STATES INTERNATIONAL TRADE COMMISSION

Washington, D.C.

In the Matter of

**CERTAIN MOBILE DEVICES,
AND RELATED SOFTWARE THEREOF**

Inv. No. 337-TA-750

**NOTICE REGARDING INITIAL DETERMINATION ON VIOLATION OF SECTION
337 AND RECOMMENDED DETERMINATION ON REMEDY AND BONDING**

(January 13, 2012)

On this date, the ALJ issued an initial determination on violation of Section 337 and recommended determination on remedy and bond in the above-referenced investigation. It is held that no violation of section 337 of the Tariff Act of 1930, as amended, 19 U.S.C. § 1337, has occurred in the importation into the United States, the sale for importation, or the sale within the United States after importation of certain mobile devices and related software by reason of infringement of one or more of Claims 1, 2, 10, 11, 24-26, and 29 U.S. Patent No. 7,812,828 ("the '828 Patent"), claims 1-7 and 10 of U.S. Patent No. 7,663,607 ("the '607 Patent"), and claims 1, 3, and 5 of the U.S. Patent No. 5,379,430 ("the '430 Patent").



Theodore R. Essex
Administrative Law Judge

**IN THE MATTER OF CERTAIN MOBILE DEVICES,
AND RELATED SOFTWARE THEREOF**

Inv. No. 337-TA-750

PUBLIC CERTIFICATE OF SERVICE

I, James R. Holbein, hereby certify that the attached **NOTICE** has been served by hand upon, the Commission Investigative Attorney, **Lisa A. Kattan, Esq.** and the following parties as indicated on **January 13, 2012.**

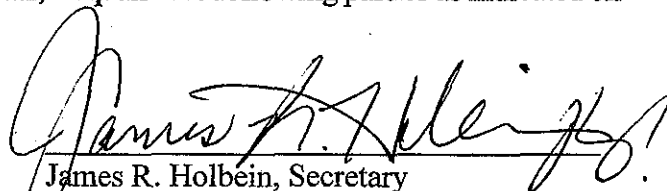
James R. Holbein, Secretary
U.S. International Trade Commission
500 E Street, SW, Room 112A
Washington, D.C. 20436

ON BEHALF OF COMPLAINANT APPLE INC.:

Mark G. Davis, Esq.
WEIL, GOTSHALL & MANGES LLP
1300 Eye Street, NW, Suite 900
Washington, DC 20005

- Via Hand Delivery
- Via Overnight Mail
- Via First Class Mail
- Other: _____

ON BEHALF OF RESPONDENT MOTOROLA MOBILITY, INC.:

Charles F. Schill, Esq.
STEPTOE & JOHNSON LLP
1330 Connecticut Avenue, NW
Washington, DC 20036

- Via Hand Delivery
- Via Overnight Mail
- Via First Class Mail
- Other: _____

PUBLIC MAILING LIST:

Heather Hall
LEXIS - NEXIS
9443 Springboro Pike
Miamisburg, OH 45342

- Via Hand Delivery
- Via Overnight Mail
- Via First Class Mail
- Other: _____

Kenneth Clair
THOMSON WEST
1100 Thirteenth Street, NW, Suite 200
Washington, D.C. 20005

- Via Hand Delivery
- Via Overnight Mail
- Via First Class Mail
- Other: _____

Initial Determination on Violation of
Section 337 and Recommended
Determination on Remedy and Bond,
Dated January 13, 2012

PUBLIC VERSION

UNITED STATES INTERNATIONAL TRADE COMMISSION
Washington, D.C.

In the Matter of

CERTAIN MOBILE DEVICES AND
RELATED SOFTWARE

Inv. No. 337-TA-750

INITIAL DETERMINATION ON VIOLATION OF SECTION 337 AND
RECOMMENDED DETERMINATION ON REMEDY AND BOND

Administrative Law Judge Theodore R. Essex

(January 13, 2012)

Appearances:

For the Complainant Apple, Inc.:

Mark G. Davis, Esq., Brian E. Ferguson, Esq., Robert T. Vlasis, Esq., Edward S. Jou, Esq.,
Christopher T. Marando, Esq. of Weil, Gotshal & Manges LLP of Washington, D.C.

Anne M. Cappella, Esq., Jill J. Ho, Esq., Brian C. Chang, Esq.
of Weil, Gotshal & Manges LLP of Redwood Shores, California

Matthew D. Powers, Esq., Steven S. Cherenky, Esq., Paul T. Ehrlich, Esq.,
Robert L. Gerrity, Esq., of Tensegrity Law Group LLP of Redwood Shores, California

For the Respondent Motorola Mobility, Inc.:

Charles F. Schill, Esq. and Jamie B. Beaver, Esq. of
Steptoe & Johnson LLP of Washington, D.C.

Charles K. Verhoeven, Esq. and David Eiseman, Esq. of
Quinn Emanuel Urquhart & Sullivan LLP of San Francisco, California

Edward J. DeFranco, Esq. and Stephen T. Straub, Esq. of
Quinn Emanuel Urquhart & Sullivan LLP of New York, New York

David A. Nelson, Esq. of
Quinn Emanuel Urquhart & Sullivan LLP of Chicago, Illinois

For the Commission Investigative Staff:

Lynn I. Levine, Esq., Director; Anne M. Goalwin, Esq., Supervising Attorney; Lisa M. Kattan,
Esq., Investigative Attorney of the Office of Unfair Import Investigations, U.S. International
Trade Commission, of Washington, D.C.

CONTAINS CONFIDENTIAL BUSINESS INFORMATION

Pursuant to the Notice of Investigation, 75 Fed. Reg. 74081 (November 30, 2010), this is the Initial Determination of the in the matter of *Certain Mobile Devices and Related Software*, United States International Trade Commission Investigation No. 337-TA-750. See 19 C.F.R. § 210.42(a).

It is held that no violation of section 337 of the Tariff Act of 1930, as amended, 19 U.S.C. § 1337, has occurred in the importation into the United States, the sale for importation, or the sale within the United States after importation of certain mobile devices and related software by reason of infringement of one or more of Claims 1, 2, 10, 11, 24-26, and 29 U.S. Patent No. 7,812,828 (“the ’828 Patent”), claims 1-7 and 10 of U.S. Patent No. 7,663,607 (“the ’607 Patent”), and claims 1, 3, and 5 of the U.S. Patent No. 5,379,430 (“the ’430 Patent”).

PUBLIC VERSION

TABLE OF CONTENTS

I. BACKGROUND 1

 A. Institution and Procedural History of This Investigation..... 1

 B. The Parties 2

 C. The Patents at Issue and Overview of the Technology..... 2

 1. The '828 Patent 2

 2. The '607 Patent 4

 3. The '430 Patent 6

 D. The Products At Issue..... 7

 1. '828 Patent 7

 2. '607 Patent 7

 3. '430 Patent 7

II. IMPORTATION OR SALE 8

III. JURISDICTION 9

 A. Personal and Subject Matter Jurisdiction 9

IV. CLAIM CONSTRUCTION..... 10

 A. Applicable Law..... 10

 B. Level of Ordinary Skill in the Art 16

 1. '828 Patent 16

 2. '607 Patent 17

 3. '430 Patent 18

 C. The '828 Patent..... 18

 1. “mathematically fit(ting) an ellipse” 18

 2. “ellipse parameters” (claims 2, 11, 29) 31

 3. “means for fitting an ellipse to at least one of the pixel groups” (claim 24)..... 31

 4. “proximity” and “electrode” terms..... 34

 5. “a calibration module operatively coupled to the electronic scanning hardware and adapted to construct a proximity image having a plurality of pixels corresponding to the touch-sensing electrodes” (claim 10) 40

 6. “each pixel group representing proximity of a distinguishable hand part or other touch object” (claim 1, 10)..... 41

 7. “contact tracking and identification module” (claim 10) 42

 8. “means for producing a proximity image representing a scan of a plurality of electrodes of a touch-sensitive surface, the proximity image having a plurality of pixels corresponding to the touch-sensing electrodes” (claim 24) 43

 9. “segment(ing)” terms 45

 10. “means for segmenting the proximity image into one or more pixel groups, each pixel group representing a touch object on or near the touch-sensitive surface” (claim 24) 46

 11. “transmitting one or more ellipse parameters as a control signal to an electronic or electromechanical device” (claim 2)/“transmit one or more ellipse parameters as a control signal to an electronic or electromechanical device” (claim 11)..... 47

 12. “means for transmitting one or more ellipse parameters as a control signal to an electronic or electromechanical device” (claim 29) 48

 13. “Adapted to” 49

 D. The '607 Patent..... 49

 1. “electrically isolated” (claims 1-7)..... 49

 2. “operatively coupled” 50

 3. “Glass member” 52

CONTAINS CONFIDENTIAL BUSINESS INFORMATION

- E. The '430 Patent..... 53
 - 1. “dynamically adding support for hardware or software components with one or more properties” (Claim 1)..... 53
 - 2. component” terms 58
 - 3. specifying a target hardware or software component search criteria including one or more properties” (claim 1) 60
 - 4. “querying the operating system” (claim 1) 65
 - 5. “returning hardware or software components meeting the target hardware or software component search criteria” (Claim 1) 66
 - 6. “adding support for the hardware and software components to the operating system” (Claim 1) 69
- V. INFRINGEMENT DETERMINATION 73
 - A. Applicable Law..... 73
 - B. The '828 Patent..... 78
 - 1. Mathematically Fit(ing) An Ellipse 78
 - C. The '607 Patent..... 108
 - 1. Claim 1 108
 - 2. Claims 2 and 3..... 117
 - 3. Claims 4 and 5..... 118
 - 4. Claim 6..... 122
 - 5. Claim 7..... 122
 - 6. Claim 10..... 122
 - D. The '430 Patent..... 129
 - 1. specifying a target hardware or software component search criteria including one or more properties..... 129
 - 2. querying the operating system to identify one or more hardware or software components that meet the target hardware or software component search criteria..... 131
 - 3. returning hardware or software components meeting the target hardware or software component search criteria..... 132
 - 4. adding support for the hardware and software components to the operating system without rebooting the operating system 133
- VI. VALIDITY 135
 - A. Background..... 135
 - B. Anticipation 136
 - 1. The '828 Patent 139
 - 2. The '607 Patent 141
 - 3. The '430 Patent 149
 - C. Obviousness..... 166
 - 1. The '828 Patent 171
 - 2. The '607 Patent 172
 - 3. The '430 Patent 178
 - D. Written Description 178
 - E. Enablement 179
 - F. Best Mode..... 180
 - G. Indefiniteness..... 184
- VII. Standing and Licensing..... 184
 - A. Standing..... 184
 - B. Licensing 186
 - 1. Motorola and IBM License 187
 - 2. History of Taligent Ownership..... 187
 - 3. The Assignment Of Taligent’s Patents To OTLC..... 188

CONTAINS CONFIDENTIAL BUSINESS INFORMATION

- 4. Arguments..... 188
- VIII. DOMESTIC INDUSTRY 193
 - A. Applicable Law..... 193
 - B. Technical Prong..... 197
 - 1. The '828 Patent 197
 - 2. The '607 Patent 198
 - 3. The '430 Patent 202
 - C. Economic Prong 203
- IX. CONCLUSIONS OF LAW 204
- X. INITIAL DETERMINATION AND ORDER 205
 - I. Remedy and Bonding 206
 - A. Limited Exclusion Order 206
 - B. Cease and Desist Order..... 208
 - C. Bond During Presidential Review Period..... 209
 - II. Conclusion 211

PUBLIC VERSION

The following abbreviations may be used in this Initial Determination:

CDX	Complainant's demonstrative exhibit
CIB	Complainant's initial post-hearing brief
CPX	Complainant's physical exhibit
CRB	Complainant's reply post-hearing brief
CX	Complainant's exhibit
Dep.	Deposition
JX	Joint Exhibit
RDX	Respondent's demonstrative exhibit
RIB	Respondent's initial post-hearing brief
RPX	Respondent's physical exhibit
RRB	Respondent's reply post-hearing brief
RRX	Respondent's rebuttal exhibit
RX	Respondent's exhibit
SIB	Staff's initial post-hearing brief
SRB	Staff's reply post-hearing brief
Tr.	Transcript

PUBLIC VERSION

I. BACKGROUND

A. Institution and Procedural History of This Investigation

By publication of a notice in the *Federal Register* on November 30, 2010, pursuant to subsection (b) of section 337 of the Tariff Act of 1930, as amended, the Commission instituted Investigation No. 337-TA-750 with respect to U.S. Patent Nos. 7,812,828 (“the ’828 Patent”), 7,663,607 (“the ’607 Patent”), 5,379,430 (“the ’430 Patent”) to determine:

[W]hether there is a violation of subsection (a)(1)(B) of section 337 in the importation into the United States, the sale for importation, or the sale within the United States after importation of certain mobile devices and related software that infringe one or more of claims 1, 2, 10, 11, 24-26 and 29 of the ’828 patent; claims 1-7 and 10 of the ’607 patent; claims 1, 3, and 5 of the ’430 patent, and whether an industry in the United States exists as required by subsection (a)(2) of section 337.

75 Fed. Reg. 74081 (November 30, 2010).

The complainant is Apple Inc., f/k/a Apple Computer, Inc. (“Apple”) of Cupertino, California. The respondents were Motorola, Inc. of Schaumburg, Illinois and Motorola Mobility, Inc. of Libertyville, Illinois. The Commission Investigative Staff of the Office of Unfair Import Investigations is also a party in this investigation. (*Id.*)

The parties filed a joint unopposed motion to terminate Motorola Inc. on July 28, 2011, which was granted on August 16, 2011. (*See* Order No. 10.) The Commission determined not to review the Initial Determination Terminating the Investigation as to Motorola, Inc. n/k/a Motorola Solutions, Inc. on August 31, 2011. (*See* Notice of a Commission Determination Not to Review an Initial Determination Terminating the Investigation as to Motorola, Inc. n/k/a Motorola Solutions, Inc.) (August 31, 2011).

Apple filed a Motion for Summary Determination that it has Satisfied the Economic Prong of the Domestic Industry Requirement on August 28, 2011, which was granted on

PUBLIC VERSION

September 15, 2011. (*See* Order No. 14.) The Commission determined not to review the Initial Determination granting the motion on October 14, 2011. (*See* Notice of a Commission Determination Not to Review an Initial Determination Granting Complainant’s Motion for Summary Determination on the Economic Prong of the Domestic Industry Requirement) (October 14, 2011).

The evidentiary hearing took place from September 26-30, 2011.

B. The Parties

Apple is a California corporation with its headquarters located in Cupertino, California. Apple is in the business of, *inter alia*, developing, manufacturing, and selling innovative electronic devices and software. (JX-491 at 2.)

Motorola Mobility, Inc. (“Motorola”) is a Delaware corporation formed in January 2011 as a spinoff of Motorola, Inc. and is located in Libertyville, Illinois. Motorola is in the business of, *inter alia*, developing, manufacturing, and selling innovative mobile electronic devices. (RX-1887C at Q10.)

C. The Patents at Issue and Overview of the Technology

1. The ’828 Patent

U.S. Patent No. 7,812,828 (“the ’828 Patent”), entitled “Ellipse Fitting for Multi-Touch Surfaces,” was filed on February 22, 2007, and issued on October 12, 2010. (*See* JX-3). Wayne Westerman and John G. Elias are the named inventors of the ’828 Patent, and complainant Apple, Inc. is the named assignee. (*Id.* & CX-365.) The ’828 Patent claims priority back to two patent applications. The first of which was filed January 25, 1999. (JX-3.) The patent also claims priority to a provisional patent application filed January 26, 1998. (JX-3.)

PUBLIC VERSION

The asserted claims of the '828 Patent are claims 1, 2, 10, 11, 24-26, and 29. These claims read as follows (with the disputed claim terms in **bold**):

1. A method of processing input from a touch-sensitive surface, the method comprising: receiving at least one proximity image representing a scan of a plurality of electrodes of the touch-sensitive surface; segmenting each proximity image into one or more pixel groups that indicate significant proximity, each pixel group representing proximity of a distinguishable hand part or other touch object on or near the touch-sensitive surface; and **mathematically fitting an ellipse to at least one of the pixel groups.**

2. The method of claim 1 further comprising transmitting one or more ellipse parameters as a control signal to an electronic or electromechanical device.

10. A touch-sensing device comprising: a substrate; a plurality of touch-sensing electrodes arranged on the substrate; electronic scanning hardware adapted to read the plurality of touch-sensing electrodes; a calibration module operatively coupled to the electronic scanning hardware and adapted to construct a proximity image having a plurality of pixels corresponding to the touch-sensing electrodes; and a contact tracking and identification module adapted to: segment the proximity image into one or more pixel groups, each pixel group representing proximity of a distinguishable hand part or other touch object on or near the touch-sensitive surface; and **mathematically fit an ellipse to at least one of the one or more pixel groups.**

11. The touch-sensing device of claim 10 further comprising a host communication interface adapted to transmit one or more ellipse parameters as a control signal to an electronic or electromechanical device.

24. A touch-sensing device comprising: means for producing a proximity image representing a scan of a plurality of electrodes of a touch-sensitive surface, the proximity image having a plurality of pixels corresponding to the touch-sensing electrodes; and means for segmenting the proximity image into one or more pixel groups, each pixel group representing a touch object on or near the touch-sensitive surface; and **means for fitting an ellipse to at least one of the pixel groups.**

25. The touch-sensing device of claim 24 wherein the touch object comprises at least a portion of a hand.

26. The touch-sensing device of claim 24 wherein the touch object comprises at least a portion of one or more fingers.

PUBLIC VERSION

29. The touch-sensing device of claim 24 further comprising means for transmitting one or more ellipse parameters as a control signal to an electronic or electromechanical device.

The '828 Patent generally discloses and claims an apparatus and method for simultaneously tracking multiple finger and palm contacts as hands approach, touch, and slide across a proximity-sensing, multi-touch surface. (*Id.* at Abstract.)

2. The '607 Patent

U.S. Patent No. 7,663,607 (“the '607 Patent”), entitled “Multipoint Touchscreen,” was filed on May 6, 2004, and issued on February 16, 2010. (*See* JX-2 (the '607 Patent)). Steve Hotelling, Joshua A. Strickon, and Brian Q. Huppi are the named inventors of the '607 Patent and complainant Apple is the assignee. (*Id.*)

The asserted claims of the '607 Patent are claims 1-7 and 10. These claims read as follows (with the disputed claim terms in **bold**):

1. A touch panel comprising a transparent capacitive sensing medium configured to detect multiple touches or near touches that occur at a same time and at distinct locations in a plane of the touch panel and to produce distinct signals representative of a location of the touches on the plane of the touch panel for each of the multiple touches, wherein the transparent capacitive sensing medium comprises: a first layer having a plurality of transparent first conductive lines that are **electrically isolated** from one another; and a second layer spatially separated from the first layer and having a plurality of transparent second conductive lines that are electrically isolated from one another, the second conductive lines being positioned transverse to the first conductive lines, the intersection of transverse lines being positioned at different locations in the plane of the touch panel, each of the second conductive lines being **operatively coupled** to capacitive monitoring circuitry; wherein the capacitive monitoring circuitry is configured to detect changes in charge coupling between the first conductive lines and the second conductive lines.

2. The touch panel as recited in claim 1 wherein the conductive lines on each of the layers are substantially parallel to one another.

3. The touch panel as recited in claim 2 wherein the conductive lines on different layers are substantially perpendicular to one another.

PUBLIC VERSION

4. The touch panel as recited in claim 1 wherein the transparent first conductive lines of the first layer are disposed on a first **glass member**, and wherein the transparent second conductive lines of the second layer are disposed on a second **glass member**, the first glass member being disposed over the second glass member.

5. The touch panel as recited in claim 4 further including a third **glass member** disposed over the first glass member, the first and second glass members being attached to one another via an adhesive layer, the third glass member being attached to the first glass member via another adhesive layer.

6. The touch panel as recited in claim 1 wherein the conductive lines are formed from indium tin oxide (ITO).

7. The touch panel as recited in claim 1, wherein the capacitive sensing medium is a mutual capacitance sensing medium.

10. A display arrangement comprising: a display having a screen for displaying a graphical user interface; and a transparent touch panel allowing the screen to be viewed therethrough and capable of recognizing multiple touch events that occur at different locations on the touch panel at a same time and to output this information to a host device to form a pixilated image; wherein the touch panel includes a multipoint sensing arrangement configured to simultaneously detect and monitor the touch events and a change in capacitive coupling associated with those touch events at distinct points across the touch panel; and wherein the touch panel comprises: a first **glass member** disposed over the screen of the display; a first transparent conductive layer disposed over the first glass member, the first transparent conductive layer comprising a plurality of spaced apart parallel lines having the same pitch and linewidths; a second **glass member** disposed over the first transparent conductive layer; a second transparent conductive layer disposed over the second glass member, the second transparent conductive layer comprising a plurality of spaced apart parallel lines having the same pitch and linewidths, the parallel lines of the second transparent conductive layer being substantially perpendicular to the parallel lines of the first transparent conductive layer; a third **glass member** disposed over the second transparent conductive layer; and one or more sensor integrated circuits **operatively coupled** to the lines.

The '607 Patent generally discloses and claims an apparatus for a touch panel having a transparent capacitive sensing medium configured to detect multiple touches or near touches that occur at the same time and at distinct locations in the plane of the touch panel and to produce distinct signals representative of the location of the touches on the plane of the touch panel for each of the multiple touches is disclosed. (*Id.* at Abstract.)

PUBLIC VERSION

3. The '430 Patent

U.S. Patent No. 5,379,430 (“the ‘430 Patent”), entitled “Object-Oriented System Locator ,” was filed on August 4, 1993, and issued on January 3, 1995. (See JX-1 (the ‘430 Patent)). Frank T. Nguyen is the named inventor of the ‘430 Patent. The patent was originally assigned to Taligent, Inc. and Apple alleges that it is the current owner. (*Id.* and JX-489)

The asserted claims of the ‘430 Patent are claims 1, 3 and 5. These claims read as follows:

1. A computer implemented method for **dynamically adding support for hardware or software components** with one or more **properties** to an operating system active on a computer with a memory, comprising the steps of:

(a) specifying a target **hardware or software component** search criteria including one or more **properties**;

(b) **querying the operating system** to identify one or more hardware or software components that meet the target hardware or software component search criteria;

(c) **returning hardware or software components meeting the target hardware or software component search criteria**; and

(d) **adding support for the hardware and software components to the operating system** without rebooting the operating system.

3. A method as recited in claim 1, wherein the hardware or software components include system components.

5. A method as recited in claim 1, wherein the software components include application components.

The ‘430 Patent generally discloses and claims a method and system for adding system components (documents, tools, fonts, libraries, etc.) to a computer system without running an installation program. (*Id.* at Abstract.)

PUBLIC VERSION

D. The Products At Issue

The accused products are, broadly, mobile devices and tablet computers with touchscreens. (CIB at 1-2.) Apple has accused slightly different groups of products of infringing the three Asserted Patents and those groups of accused products are set forth below.

1. '828 Patent

Apple accuses Motorola's multi-touch devices of infringing the '828 Patent. These include the: Motorola Atrix, Bravo, Charm, Citrus, Cliq 2, Cliq XT/Quench, Defy, Droid, Droid 2, Droid 2 Global, Droid Bionic, Droid Pro, Droid X, Droid X2, Droid 3, Flipout, Flipside, i1, Titanium, Xoom, and XPRT (collectively, the "Accused '828 Products").¹

2. '607 Patent

Apple accuses Motorola mobile devices that include multi-point touchscreens of infringing the '607 Patent. These include the following: Motorola Atrix, Bravo, Charm, Citrus, Cliq 2, Defy, Droid, Droid 2, Droid 2 Global, Droid Bionic, Droid Pro, Droid X, Droid X2, Droid 3, Flipout, Flipside, Titanium, and XPRT (collectively "the '607 Accused Products").

3. '430 Patent

Apple accuses all Motorola mobile devices that run the Android operating system of infringing the '430 Patent. These include Motorola mobile devices that run Android 1.5-3.1: Motorola Atrix, Bravo, Charm, Citrus, Cliq, Cliq/Dext, Cliq 2, Cliq XT/Quench, Defy, Devour, Droid, Droid 2, Droid 2 Global, Droid Bionic, Droid Pro, Droid X, Droid X2, Droid 3, Flipout, Flipside, i1, Titanium, Xoom (4G/LTE), Xoom (Everest), Xoom (UMTS), Xoom (Wi-Fi), and XPRT (collectively, the "Accused '430 Products").

¹ There seems to be some inconsistency between the parties as to whether the i1 is still accused of infringing the '828 Patent. (Compare CIB at 14 with RIB at 10 n.2.)

PUBLIC VERSION

II. IMPORTATION OR SALE

Section 337 of the Tariff Act prohibits the importation into the United States, the sale for importation, or the sale within the United States after importation by the owner, importer, or consignees of articles that infringe a valid and enforceable United States patent. *See* 19 U.S.C. § 1337(a)(1)(B). A complainant “need only prove importation of a single accused product to satisfy the importation element.” *Certain Purple Protective Gloves*, 337-TA-500, Order No. 17 (September 23, 2004). The importation requirement can be established through a summary determination motion and irrespective of any finding of infringement of the patents in issue. *See Certain Wireless Communications Equipment, Articles Therein, and Products Containing Same*, 337-TA-577, Order No. 18 (February 22, 2007); *Certain Automated Mechanical Transmission Systems for Medium-Duty and Heavy Duty Trucks and Components Thereof*, 337-TA-503, Order No. 38 (August 12, 2004); *Certain Audio Digital-To-Analog Converters and Products Containing Same*, 337-TA-499, Order No. 15 (June 29, 2004), Notice of Commission Not To Review (July 28, 2004).

On September 16, 2011, Apple and Motorola stipulated that Motorola has imported, sold for importation, or sold after importation in the United States at least one unit of each Accused Product and that there is no dispute that the importation requirement has been satisfied. (Joint Stipulation Regarding Respondent Motorola Mobility, Inc.’s Importation of Accused Products and Motorola Mobility, Inc.’s IBM License Rights (September 19, 2011); *see also* CIB at 15; RIB at 11.) Accordingly, the ALJ finds that Apple has established the importation requirement.

PUBLIC VERSION

III. JURISDICTION**A. Personal and Subject Matter Jurisdiction**

In order to have the power to decide a case, a court or agency must have both subject matter jurisdiction and jurisdiction over either the parties or the property involved. *See Certain Steel Rod Treating Apparatus and Components Thereof*, Inv. No. 337-TA-97, Commission Memorandum Opinion, 215 U.S.P.Q. 229, 231 (1981). For the reasons discussed below, the ALJ finds the Commission has jurisdiction over this investigation.

Section 337 declares unlawful the importation, the sale for importation, or the sale after importation into the United States of articles that infringe a valid and enforceable United States patent by the owner, importer, or consignee of the articles, if an industry relating to the articles protected by the patent exists or is in the process of being established in the United States. *See* 19 U.S.C. §§ 1337(a)(1)(B)(I) and (a)(2). Pursuant to Section 337, the Commission shall investigate alleged violations of the Section and hear and decide actions involving those alleged violations.

As set forth *supra* in Section II, Apple has met the importation requirement. Furthermore, the parties do not dispute that the Commission has *in personam* and *in rem* jurisdiction.² (CIB at 15; RIB at 11.) Motorola has fully participated in the investigation, including participating in discovery, participating in the hearing, and filing pre-hearing and post-hearing briefs. Accordingly, the ALJ finds that Motorola has submitted to the jurisdiction of the Commission. *See Certain Miniature Hacksaws*, Inv. No. 337-TA-237, Pub. No. 1948, Initial Determination at 4, 1986 WL 379287 (U.S.I.T.C., October 15, 1986) (unreviewed by Commission in relevant part).

² Motorola asserts that Apple does not have standing to bring suit under the '430 Patent. That is addressed *infra* at Section VI.H.1.

PUBLIC VERSION

IV. CLAIM CONSTRUCTION

A. Applicable Law

Pursuant to the Commission's Notice of Investigation, this investigation is a patent-based investigation. *See* 75 Fed. Reg. 74081 (November 30, 2010). Accordingly, all of the unfair acts alleged by Apple to have occurred are instances of alleged infringement of the '828, '607 and '430 Patents. A finding of infringement or non-infringement requires a two-step analytical approach. First, the asserted patent claims must be construed as a matter of law to determine their proper scope.³ Claim interpretation is a question of law. *Markman v. Westview Instruments, Inc.*, 52 F.3d 967, 979 (Fed. Cir. 1995) (*en banc*), *aff'd*, 517 U.S. 370 (1996); *Cybor Corp. v. FAS Techs., Inc.*, 138 F.3d 1448, 1455 (Fed. Cir. 1998). Second, a factual determination must be made as to whether the properly construed claims read on the accused devices. (*Id.* at 976).

In construing claims, the ALJ should first look to intrinsic evidence, which consists of the language of the claims, the patent's specification, and the prosecution history, as such evidence "is the most significant source of the legally operative meaning of disputed claim language." *Vitronics Corp. v. Conception, Inc.*, 90 F.3d 1576, 1582 (Fed. Cir. 1996); *see also Bell Atl. Network Servs., Inc. v. Covad Comm'n. Group, Inc.*, 262 F.3d 1258, 1267 (Fed. Cir. 2001). The words of the claims "define the scope of the patented invention." *Id.* And, the claims themselves "provide substantial guidance as to the meaning of particular claim terms." *Phillips v. AWH Corp.*, 415 F.3d 1303, 1314 (Fed. Cir. 2005), *cert. denied*, 546 U.S. 1170 (2006). It is essential to consider a claim as a whole when construing each term, because the context in which a term is used in a claim "can be highly instructive." *Id.* Claim terms are presumed to be used consistently throughout the patent, such that the usage of the term in one claim can often

³ Only claim terms in controversy need to be construed, and only to the extent necessary to resolve the controversy. *Vanderlande Indus. Nederland BV v. Int'l Trade Comm'n.*, 366 F.3d 1311, 1323 (Fed. Cir. 2004); *Vivid Tech., Inc. v. Am. Sci. & Eng'g, Inc.*, 200 F.3d 795, 803 (Fed. Cir. 1999).

PUBLIC VERSION

illuminate the meaning of the same term in other claims. *Research Plastics, Inc. v. Federal Pkg. Corp.*, 421 F.3d 1290, 1295 (Fed. Cir. 2005). In addition:

. . . in clarifying the meaning of claim terms, courts are free to use words that do not appear in the claim so long as the resulting claim interpretation . . . accord[s] with the words chosen by the patentee to stake out the boundary of the claimed property.

Pause Tech., Inc. v. TIVO, Inc., 419 F.3d 1326, 1333 (Fed. Cir. 2005).

Some claim terms do not have particular meaning in a field of art, in which case claim construction involves little more than applying the widely accepted meaning of commonly understood words. *Phillips*, 415 F.3d at 1314. Under such circumstances, a general purpose dictionary may be of use.⁴ The presumption of ordinary meaning, however, will be “rebutted if the inventor has disavowed or disclaimed scope of coverage, by using words or expressions of manifest exclusion or restriction, representing a clear disavowal of claim scope.” *ACTV, Inc. v. Walt Disney Co.*, 346 F.3d 1082, 1091 (Fed. Cir. 2003).

Sometimes a claim term will have a specialized meaning in a field of art, in which case it is necessary to determine what a person of ordinary skill in that field of art would understand the disputed claim language to mean, viewing the claim terms in the context of the entire patent. *Phillips*, 415 F.3d at 1312-14; *Vitronics*, 90 F.3d at 1582. Under such circumstances, the ALJ must conduct an analysis of the words of the claims themselves, the patent specification, the prosecution history, and extrinsic evidence concerning relevant scientific principles, as well as the meaning of technical terms and the state of the art. *Id.*

A patentee may deviate from the conventional meaning of claim term by making his or her intended meaning clear (1) in the specification and/or (2) during the patent’s prosecution

⁴ Use of a dictionary, however, may extend patent protection beyond that to which a patent should properly be afforded. There is also no guarantee that a term is used the same way in a treatise as it would be by a patentee. *Id.* at 1322.

PUBLIC VERSION

history. *Lear Siegler, Inc. v. Aeroquip Corp.*, 733 F.2d 881, 889 (Fed. Cir. 1984). If a claim term is defined contrary to the meaning given to it by those of ordinary skill in the art, the specification must communicate a deliberate and clear preference for the alternate definition. *Kumar v. Ovonic Battery Co.*, 351 F.3d 1364, 1368 (Fed. Cir. 2003). In other words, the intrinsic evidence must “clearly set forth” or “clearly redefine” a claim term so as to put one reasonably skilled in the art on notice that the patentee intended to so redefine the claim term. *Bell Atl.*, 262 F.3d at 1268.

When the meaning of a claim term is uncertain, the specification is usually the first and best place to look, aside from the claim itself, in order to find that meaning. *Phillips*, 415 F.3d at 1315. The specification of a patent “acts as a dictionary” both “when it expressly defines terms used in the claims” and “when it defines terms by implication.” *Vitronics*, 90 F.3d at 1582. For example, the specification “may define claim terms by implication such that the meaning may be found in or ascertained by a reading of the patent documents.” *Phillips*, 415 F.3d at 1323. “The construction that stays true to the claim language and most naturally aligns with the patent’s description of the invention will be, in the end, the correct construction.” *Id.* at 1316. However, as a general rule, particular examples or embodiments discussed in the specification are not to be read into the claims as limitations. *Markman*, 52 F.3d at 979.

The prosecution history “provides evidence of how the inventor and the PTO understood the patent.” *Phillips*, 415 F.3d at 1317. For example, the prosecution history may inform the meaning of the claim language by demonstrating how an inventor understood the invention and whether the inventor limited the invention in the course of prosecution, making the claim scope narrower than it otherwise would be. *Vitronics*, 90 F.3d at 1582-83; *see also Chimie v. PPG Indus., Inc.*, 402 F.3d 1371, 1384 (Fed. Cir. 2005) (stating, “The purpose of consulting the

PUBLIC VERSION

prosecution history in construing a claim is to exclude any interpretation that was disclaimed during prosecution.”); *Microsoft Corp. v. Multi-tech Sys., Inc.*, 357 F.3d 1340, 1350 (Fed. Cir. 2004) (stating, “We have held that a statement made by the patentee during prosecution history of a patent in the same family as the patent-in-suit can operate as a disclaimer.”). The prosecution history includes the prior art cited, *Phillips*, 415 F.3d at 1317, as well as any reexamination of the patent. *E.I. du Pont de Nemours & Co. v. Phillips Petroleum Co.* 849 F.2d 1430, 1440 (Fed. Cir. 1988) (“Statements made during reissue are relevant prosecution history when interpreting claims.”) (internal citations omitted).

Differences between claims may be helpful in understanding the meaning of claim terms. *Phillips*, 415 F.3d at 1314. A claim construction that gives meaning to all the terms of a claim is preferred over one that does not do so. *Merck & Co. v. Teva Pharms. USA, Inc.*, 395 F.3d 1364, 1372 (Fed. Cir.), *cert. denied*, 546 U.S. 972 (2005); *Alza Corp. v. Mylan Labs. Inc.*, 391 F.3d 1365, 1370 (Fed. Cir. 2004). In addition, the presence of a specific limitation in a dependent claim raises a presumption that the limitation is not present in the independent claim. *Phillips*, 415 F.3d at 1315. This presumption of claim differentiation is especially strong when the only difference between the independent and dependent claim is the limitation in dispute. *SunRace Roots Enter. Co., v. SRAM Corp.*, 336 F.3d 1298, 1303 (Fed. Cir. 2003). “[C]laim differentiation takes on relevance in the context of a claim construction that would render additional, or different, language in another independent claim superfluous.” *AllVoice Computing PLC v. Nuance Comm’ns, Inc.*, 504 F.3d 1236, 1247 (Fed. Cir. 2007).

The preamble of a claim may also be significant in interpreting that claim. The preamble is generally not construed to be a limitation on a claim. *Bell Commc’ns Research, Inc. v.*

PUBLIC VERSION

Vitalink Commc'ns Corp., 55 F.3d 615, 620 (Fed. Cir. 1995). However, the Federal Circuit has stated that:

[A] claim preamble has the import that the claim as a whole suggests for it. In other words, when the claim drafter chooses to use both the preamble and the body to define the subject matter of the claimed invention, the invention so defined, and not some other, is the one the patent protects.

Eaton Corp. v. Rockwell Int'l Corp., 323 F.3d 1332, 1339 (Fed. Cir. 2003). If said preamble, when read in the context of an entire claim, recites limitations of the claim, or if the claim preamble is “necessary to give life, meaning, and vitality” to the claim, then the claim preamble should be construed as if in the balance of the claim. *Kropa v. Robie*, 187 F.2d 150, 152 (CCPA 1951); *see also Rowe v. Dror*, 112 F.3d 473, 478 (Fed. Cir. 1997); *Corning Glass Works v. Sumitomo Elec. U.S.A., Inc.*, 868 F.2d 1251, 1257 (Fed. Cir. 1989). In addition:

[W]hen discussing the “claim” in such a circumstance, there is no meaningful distinction to be drawn between the claim preamble and the rest of the claim, for only together do they comprise the “claim.” If, however, the body of the claim fully and intrinsically sets forth the complete invention, including all of its limitations, and the preamble offers no distinct definition of any of the claimed invention’s limitations, but rather merely states the purpose or intended use of the invention, then the preamble may have no significance to claim construction because it cannot be said to constitute or explain a claim limitation.

Pitney Bowes, Inc. v. Hewlett-Packard Co., 182 F.3d 1298, 1305 (Fed. Cir. 1999). In *Pitney Bowes*, the claim preamble stated that the patent claimed a method of, or apparatus for, “producing on a photoreceptor an image of generated shapes made up of spots.” *Id.* at 1306. The Federal Circuit found that this was not merely a statement describing the invention’s intended field of use, but rather that said statement was intimately meshed with the ensuing language in the claim. *Id.* For example, both of the patent’s independent claims concluded with the clause, “whereby the appearance of smoothed edges are given to the generated shapes.” *Id.* Because this was the first appearance in the claim body of the term “generated shapes,” the Court

PUBLIC VERSION

found that it could only be understood in the context of the preamble statement “producing on a photoreceptor an image of generated shapes made up of spots.” *Id.* The Court concluded that it was essential that the preamble and the remainder of the claim be construed as one unified and internally consistent recitation of the claimed invention. *Id.*

Finally, when the intrinsic evidence does not establish the meaning of a claim, the ALJ may consider extrinsic evidence, *i.e.*, all evidence external to the patent and the prosecution history, including inventor testimony, expert testimony and learned treatises. *Phillips*, 415 F.3d at 1317. Extrinsic evidence may be helpful in explaining scientific principles, the meaning of technical terms, and terms of art. *Vitronics*, 90 F.3d at 1583; *Markman*, 52 F.3d at 980. However, the Federal Circuit has generally viewed extrinsic evidence as less reliable than the patent itself and its prosecution history in determining how to define claim terms. *Phillips*, 415 F.3d at 1318. With respect to expert witnesses, any testimony that is clearly at odds with the claim construction mandated by the claims themselves, the patent specification, and the prosecution history should be discounted. *Id.* at 1318.

If the meaning of a claim term remains ambiguous after a review of the intrinsic and extrinsic evidence, then the patent claims should be construed so as to maintain their validity. *Id.* at 1327. However, if the only reasonable interpretation renders a claim invalid, then the claim should be found invalid. *See Rhine v. Casio, Inc.*, 183 F.3d 1342, 1345 (Fed. Cir. 1999).

Section 112, paragraph 6 of the Patent Act states that:

An element in a claim for a combination may be expressed as a means or step for performing a specified function without the recital of structure, material, or acts in support thereof, and such claim shall be construed to cover the corresponding structure, material, or acts described in the specification and equivalents thereof.

35 U.S.C. § 112, ¶ 6 (2009).

PUBLIC VERSION

“Section 112, paragraph 6 was intended to allow the use of means expressions in patent claims without requiring the patentee to recite in the claims all possible structures that could be used as means in the claimed apparatus.” *Med. Instrumentation & Diagnostics Corp. v. Elekta AB*, 344 F.3d 1205, 1211 (Fed. Cir. 2003). The process of construing a means-plus-function term differs from the process of construing other claim language. “The first step in the construction of a means-plus-function claim element is to identify the particular claimed function. The second step in the analysis is to look to the specification and identify the corresponding structure for that function.” *Id.* at 1210 (citations omitted).

The construction of a means-plus-function term is thus limited by the disclosure of the corresponding structure in the specification. As explained by the Federal Circuit, “[t]he literal scope of a properly construed means-plus-function limitation does not extend to all means for performing a certain function. Rather, the scope of such claim language is sharply limited to the structure disclosed in the specification and its equivalents.” *J & M Corp. v. Harley-Davidson, Inc.*, 269 F.3d 1360, 1367 (Fed. Cir. 2001). Section 112, paragraph 6 has been described as representing “a *quid pro quo* by permitting inventors to use a generic means expression for a claim limitation *provided that* the specification indicates what structure(s) constitute(s) the means.” *Atmel Corp. v. Info. Storage Devices, Inc.*, 198 F.3d 1374, 1381 (Fed. Cir. 1999).

B. Level of Ordinary Skill in the Art**1. '828 Patent**

With respect to the '828 Patent, the parties largely agree on definition of person of ordinary skill at the time of the invention. Apple contends that a person of ordinary skill in the art related to the '828 Patent would have a bachelor's degree in computer science, electrical engineering, or mathematics and several years of experience working in the area of signal

PUBLIC VERSION

processing, human-computer interaction, or the design, use, or evaluation of touch-sensitive input devices. (CX-201C at Q/A 337.) Motorola contends that that a person of ordinary skill in the art related to the '828 Patent would have a bachelor's degree in computer science, electrical engineering, or a related field and three to five years of experience with input device, including some experience with image processing, human-computer interaction, or touch-sensing methods, or devices on January 25, 1999. (RX-1885C at Q/A 368.) The Staff agrees with Apple's definition, but notes that the differences between the parties' definitions do not appear to affect the outcome of any issues in this case. (SIB at 8.)

The ALJ finds that the level of ordinary skill in the art related to the '828 Patent at the time of the invention would have a bachelor's degree in computer science, electrical engineering, or a related field, including mathematics, and three to five years of experience working in the area of signal processing, human-computer interaction, or the design, use, or evaluation of touch-sensitive input devices.

2. '607 Patent

With respect to the '607 Patent, the parties largely agree on definition of person of ordinary skill at the time of the invention. Apple contends that a person of ordinary skill in the art related to the '607 Patent would have a bachelor's degree in electrical engineering, physics, computer engineering, or a related field and 2-3 years of work experience with input devices. (CX-202C at Q/A 34.) Motorola contends that that a person of ordinary skill in the art related to the '607 Patent would have a bachelor's degree in computer science, electrical engineering, or a related field and three years of experience with touch input devices. (RX-1885C at Q/A 76.) The Staff notes that the parties have offered similar definitions as to the level of ordinary skill in the art and that there does not seem to be a dispute on this issue. (SIB at 48.)

PUBLIC VERSION

The ALJ finds that the level of ordinary skill in the art related to the '607 Patent at the time of the invention would have a bachelor's degree in electrical engineering or a related field and three years of experience working in the area of touch input devices.

3. '430 Patent

With respect to the '430 Patent, the parties largely agree on definition of person of ordinary skill at the time of the invention. Apple contends that a person of ordinary skill in the art related to the '430 Patent would have a bachelor's degree in computer science, or equivalent industry experience, and several years of experience working in the area of computer programming and or operating systems. (CIB at 156 n.38; CX-201C at Q/A 34.) Motorola contends that that a person of ordinary skill in the art related to the '430 Patent would have a bachelor's degree in computer science or a related field and three years of experience in designing and developing software. (RX-1874C at Q/A 38.) The Staff notes that the parties have offered similar definitions as to the level of ordinary skill in the art and that there does not seem to be a dispute on this issue. (SIB at 98.)

The ALJ finds that the level of ordinary skill in the art related to the '430 Patent at the time of the invention would have a bachelor's degree in computer science, or equivalent industry experience, and three years of experience working in the area of computer programming and/or operating systems.

C. The '828 Patent

1. "mathematically fit(ting) an ellipse"

Claim Term	Apple's Proposed Constructions	Motorola's Proposed Constructions	Staff's Proposed Constructions
"mathematically fitting an ellipse"	comput(ing) numerical parameters	applying a unitary transformation of the group covariance matrix of second moments of	

PUBLIC VERSION

Claim Term	Apple's Proposed Constructions	Motorola's Proposed Constructions	Staff's Proposed Constructions
(claim 1) "mathematically fit an ellipse" (claim 10)	that mathematically define an ellipse	proximity data to fit an ellipse	
"mathematically fitting an ellipse to at least one of the pixel groups" (claim 1) "mathematically fit an ellipse to at least one of the one or more pixel groups" (claim 10)	comput(ing) numerical parameters that mathematically define an ellipse which approximates the shape of at least one of the pixel groups	for at least one of the pixel groups, applying a unitary transformation of the group covariance matrix of second moments of proximity data for all pixels in that pixel group to fit an ellipse	

The key dispute for the '828 Patent is whether "mathematically fitting an ellipse" is limited to the methodology defined in the patent. All of the claims contain a similar limitation, including the means plus function claims that will be discussed later. Apple proposes a construction that would have this term mean "comput(ing) numerical parameters that mathematically define an ellipse which approximates the shape of at least one of the pixel groups." Motorola and Staff propose identical constructions that construe these terms as "apply[ing] a unitary transformation of the group covariance matrix of second moments of proximity data for all pixels in a pixel group to fit an ellipse."

Motorola and Staff argue that the specification unambiguously states that "the ellipse-fitting procedure *requires* a unitary transformation of the group covariance matrix G_{cov} of second moments Q_{xx} , Q_{yy} , G_{zz} ." (JX-3 at 26:18-21 (emphasis added).) Motorola argues that the use of the word "requires" indicates that this particular technique (the group covariance matrix) must be used. (RIB at 80-82; SIB at 11-14.)

PUBLIC VERSION

Moreover, Motorola argues that the prosecution history requires this result as well. When filed, claims 1 and 10 contained the limitation “fit[ting] an ellipse to at least one of the [one or more] pixel groups.” (RIB at 82 (citing JX-6 at 150-151).) The PTO rejected all of the asserted claims based on U.S. Patent No. 5,825,352 to Bisset et al. (“Bisset”). (JX-6 at 1407-25.) In response to this rejection, the applicants argued that Bisset simply disclosed “a series of capacitance values measured when a finger contacts a touchpad, discloses the feature of ‘fitting an ellipse to’” (JX-6 at 1468.) The applicants disagreed with the examiner’s contention that “merely obtaining measured data is the same as fitting an ellipse to the data, so long as the measured data happens to be measured from an object that ‘is in general ellipse-like’ was the same as mathematically fitting an ellipse. (JX-6 at 1468-69 (quotation marks and emphasis omitted).) Indeed, the applicants contended that “the Office Action’s interpretation is particularly unreasonable when the claim language is viewed in light of the specification, as it must be viewed.” (JX-6 at 1469.) Applicants further urged that “the Office Action fails to consider the disclosure of the specification when interpreting at least the feature of ‘fitting an ellipse to at least one of the pixel groups.’” (JX-6 at 1469.) Nevertheless, applicants amended the claim to recite “mathematically fitting an ellipse to one or more pixel groups” because the examiner indicated that limitation would traverse the rejection. (JX-6 at 1469.)

Motorola also argues that Apple’s proposed construction is incorrect because it focuses on what parameters are computed and not on how parameters are computed. (RIB at 85.) Indeed, Motorola argues that the same five parameters could be could define both an ellipse and a rectangle, but that the claims require fitting an ellipse to the data. (RIB at 85.)

Apple argues that its construction is consistent with plain and ordinary meaning of the claim term – namely, “‘mathematically fit(ting) an ellipse’ is a process of computing numerical

PUBLIC VERSION

parameters that mathematically define an ellipse.” (CIB at 26.) Apple contends that “both experts explained during their tutorials that the results of an ellipse fitting process are numerical parameters that describe an ellipse, for example centroid, major axis, minor axis, and orientation.” (CIB at 27.)

Apple further contends that both experts also agree that there are a variety of methods of mathematically fitting an ellipse and that fitting is a well-known concept. (CIB at 27.) Apple argues that the specification is consistent with this plain meaning. Specifically, Apple points to statements in the specification that mention “parameters” or “parameterization.” (CIB at 27-28 (quoting JX-3 at 19:8-12 (“electrode group data structures which are parameterized by fitting an ellipse to the position and proximity measurements of the electrodes within each group”); JX-3 at 25:54-56 (“shape, size, and position parameters”).) Apple also relies on what it terms the “second embodiment” that it describes as where “the ‘total group proximity G_z ’ is used to indicate contact size and finger pressure and default mathematical values are for certain ellipse parameters rather than applying a unitary transformation of the group covariance matrix.” (CIB at 28; CIB at 30 (citing JX-3 at 27:1-8).) Apple claims that a person of ordinary skill would understand this “second embodiment” to be another form of ellipse fitting, and, thus, Motorola and Staff’s construction excludes this preferred embodiment and improperly reads limitations into the claims. (CIB at 30, 32-33.)

Apple argues that its proposed construction “follows directly from the ordinary meaning of ellipse fitting and is the only construction that does not exclude embodiments of the ’828 Patent.” (CIB at 28.) Apple argues that Motorola’s and Staff’s constructions “fail to capture the most important element of ellipse fitting – the setting of ellipse parameters – and instead focus on a single sentence describing one step of one embodiment of the ’828 Patent.” (CIB at 28.)

PUBLIC VERSION

Apple argues that the statement Motorola and the Staff rely on does not meet the Federal Circuit's requirements to be a definition, but that, even if it was, Motorola and Staff deviate from that statement by requiring the use of all pixels in the pixel group. (CIB at 29, 34-35.)

Apple also asserts that Motorola's construction runs afoul of the doctrine of claim differentiation because dependent claims 5 and 15 refer to calculating eigenvalues and eigenvectors of a covariance matrix. Apple argues that Motorola's and Staff construction would make the independent claims have the same scope as the dependent claims. (CIB at 31.) Apple also argues that the dependent claims also "support Apple's proposed construction by describing the results of ellipse fitting as a broad list of parameters that is consistent with reading the 'low resolution' embodiment as one method for 'mathematically fit(ing) an ellipse.'" (CIB at 31 (citing claims 2, 3, 11, and 12).)

Apple also relies heavily on the testimony of the named inventor Dr. Wayne Westerman as establishing that the "second embodiment" is indeed a type of ellipse fitting. (CIB at 32.) Apple further notes that Dr. Westerman explained that while fitting all of the pixels in a pixel group would be preferred, it is not required. (CIB at 34-35.)

As for the prosecution history, Apple asserts that the statements were not intended to limit the scope of the claims (CIB at 35), and that the prosecution history was not distinguishing between different ways of fitting an ellipse, but was distinguishing the claims from a reference (Bisset) that does not disclose any type of ellipse fitting. (CIB at 35.)

Instead, Apple argues that the comments in the prosecution history "only distinguishes the ellipse fitting step from the data acquisition steps that precede ellipse fitting." (CIB at 36), and that "[t]here was no comparison made between Bisset's computation of parameters and the ellipse fitting computations claimed in the '828 Patent, and, further, there can be no comparison

PUBLIC VERSION

because Bisset '352 only computed the center of the perceived touches and did not use these as part of an ellipse model, such as by assigning values to a major or minor axis.” (CIB at 36.) Apple argues that “[t]he distinction in the file history between Bisset '352 and the '828 Patent is consistent with Apple’s construction, and Motorola cannot point to any statements in the file history that refer to the ‘unitary transformation of the group covariance matrix’ in its construction.” (CIB at 36.) Apple contends that the law requires a clear and unambiguous disclaimer, and that the statements that Motorola relies on are “ambiguous at best” and do not “support Motorola’s restrictive construction.” (CIB at 36-37.)

The ALJ finds that neither Motorola’s and Staff’s nor Apple’s proposed construction is particularly appealing. While the ALJ certainly agrees with Motorola and Staff that the plain meaning of “mathematically fit(ing) and ellipse” is substantially narrower than Apple’s proposed construction, the ALJ does not agree that it is limited to only the method using the group covariance matrix disclosed in the specification. Apple’s construction is inconsistent with the claim language in that it would read out the requirement that an “ellipse” must be “fitted” “mathematically” to the pixel groups. Moreover, the specification and prosecution history also do not support Apple’s arguments as will be discussed below.

Beginning with the claim language, the claim term itself requires that an “ellipse” be “mathematically fit(ted)” to the “pixel group.” Apple’s construction would eliminate nearly all of those limitations. Moreover, Apple’s argument that its construction is the plain meaning of the term because the “*results* of an ellipse fitting process are numerical parameters that describe an ellipse. . .” highlights the key problem with Apple’s construction. Apple’s construction, in effect, is that the ends define the means. But, the independent claims do not discuss parameters at all – they merely discuss this process of fitting an ellipse. Thus, the claims focus on a

PUBLIC VERSION

particular way in which parameters could be calculated – mathematically fitting – not just on the end parameters as Apple’s construction would.

A second major problem with Apple’s construction is the tenuous connection between the ellipse and the parameters. Motorola illustrated the ambiguity that results in Apple’s construction when you focus on the parameters and not on “fitting” as the claims require. As Motorola demonstrated the parameters that could define an ellipse can also define a rectangle or other shape:

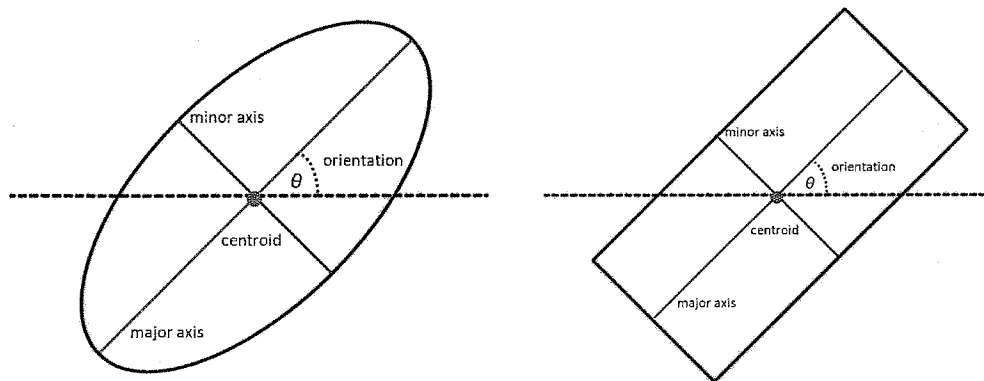

(RDX-9.36 and 9.37.) Merely calculating the parameters that could define an ellipse does not mean that the figure “fitted” to the data is an ellipse since these same parameters can define many different geometric figures. Thus, the claim language requires greater precision than merely calculating ellipse parameters; the claim language requires actually fitting an ellipse to the data.

As for Motorola’s and Staff’s construction, the claim language by itself neither supports nor refutes their construction. The use of the group covariance matrix is certainly one way that ellipse fitting can be performed. The parties do not dispute, however, that it is not the only way. Thus, Motorola’s and Staff’s construction would narrow the plain language of the claims.

The specification supports a narrower construction than Apple’s and provides some support for Motorola’s and Staff’s construction. The specification does not equate

PUBLIC VERSION

parameterization with ellipse fitting as Apple contends, but clearly explains that parameters (such as centroid, major and minor axis) are determined by ellipse fitting. (See JX-3 at 19:8-12 (“The image segmentation process 241 outputs a set of electrode group data structures 242 which *are parameterized by fitting an ellipse* to the positions and proximity measurements of the electrodes within each group.”) (emphasis added).) As for Apple’s argument that there are two embodiments for ellipse fitting, the specification demonstrates that this “second embodiment” is not ellipse fitting, but an alternative to ellipse fitting. (See JX-3 at 27:1-8 (“On low resolution electrode arrays, the total group proximity G_z is a more reliable indicator of contact size as well as finger pressure *than the fitted ellipse parameters*. Therefore, if proximity images have low resolution, the orientation and eccentricity of small contacts are set to default values rather than their measured values, and total group proximity G_z is used as the primary measure *instead of major and minor axis lengths*.”) (emphasis added)).) Thus, it is clear from the specification that the “second embodiment” is not a method of mathematically fitting an ellipse – it is a completely alternative method to analyze proximity data.

As for Motorola’s and Staff’s construction, it relies heavily on the following passage from the specification:

Since most groups are convex, their shape is well approximated by ellipse parameters. The ellipse fitting procedure requires a unitary transformation of the group covariance matrix G_{cov} of second moments Q_{xx} , Q_{yy} , G_{xy} :

$$G_{cov} = \begin{bmatrix} G_{xx} & G_{xy} \\ G_{yx} & G_{yy} \end{bmatrix} \quad (15)$$

$$G_{xx} = \sum_{e_i \in G_E} e_i (G_x - e_x)^2 \quad (16)$$

$$G_{yx} = G_{xy} = \sum_{e_i \in G_E} e_i (G_x - e_x)(G_y - e_y) \quad (17)$$

$$G_{yy} = \sum_{e_i \in G_E} e_i (G_y - e_y)^2 \quad (18)$$

PUBLIC VERSION

The eigenvalues λ_0 and λ_1 of the covariance matrix G_{cov} determine the ellipse axis lengths and orientation G_0 :

$$G_{major} = \sqrt{\lambda_0} \quad (19)$$

$$G_{minor} = \sqrt{\lambda_1} \quad (20)$$

$$G_0 = \arctan\left(\frac{\lambda_0 - G_{xx}}{G_{xy}}\right) \quad (21)$$

where G_0 is uniquely wrapped into the range $(0, 180^\circ)$.

For convenience while distinguishing fingertips from palms at higher system levels, the major and minor axis lengths are converted via their ratio into an eccentricity G_e :

$$G_e = \frac{G_{major}}{G_{minor}} \quad (22)$$

(JX-3 at 26:18-55.) This passage does provide strong support for a construction that is narrower than Apple's. It clearly indicates that "fit(ing) an ellipse" to the pixel group means what the claim language says: it requires actually fitting an ellipse to the data before the parameters are calculated, not merely calculating "parameters" that could represent an ellipse as Apple contends. The ALJ, however, disagrees with Motorola and Staff that this passage limits the claim term only to the group covariance methodology described in this passage. Motorola and Staff rely on the use of the "requires" in the description above, *i.e.*, "the ellipse fitting procedure requires."

In support of their argument, Motorola and Staff rely on an unpublished Federal Circuit opinion, *ImageCUBE LLC v. Boeing Co.*, No. 2010-1265, 2011 WL 2438634 (Fed. Cir. June 20, 2011). The ALJ finds that this case does not support Motorola's and Staff's construction. As Apple points out, the Federal Circuit did not hold that the word "requires" by itself supports reading a limitation into the claims from the specification in *ImageCUBE*. Indeed, limiting claims to particular embodiments is heady stuff not to be taken lightly. As the Federal Circuit in another case has explained:

There is a fine line between construing the claims in light of the specification and improperly importing a limitation from the specification into the claims.

PUBLIC VERSION

In reviewing the intrinsic record to construe the claims, we strive to capture the scope of the actual invention, rather than strictly limit the scope of claims to disclosed embodiments or allow the claim language to become divorced from what the specification conveys is the invention

Retractable Tech., Inc. v. Becton, Dickinson & Co., 653 F.3d 1293, 1305 (Fed. Cir. 2011).

In *Retractable Technologies*, the Federal Circuit found the claims limited to a particular embodiment in the specification where the evidence far more overwhelming than here. It included repeated emphasis that “invention” included a particular limitation. *See id.*

In sum, while these cases do not support reading the specific methodology described in the specification into the claims, the ALJ does note that, consistent with the holding in *ImageCUBE*, the specification and claims in this case clearly indicate that a mathematical fitting procedure that fits an ellipse to the pixel group must be used here. Moreover, the plain language of the claims make clear that merely calculating ellipse parameters without using a fitting technique is insufficient.

As for the final piece of evidence relied on by Motorola and Staff, the prosecution history, the ALJ finds this does not limit the claims as narrowly as Motorola and Staff suggest. But the ALJ finds that the prosecution history supports a much narrower construction than Apple proposes. As discussed above, when filed, claims 1 and 10 contained the limitation “fit[ting] an ellipse to at least one of the [one or more] pixel groups.” (*See* JX-6.0150-0151.) In an office action dated December 24, 2009, the PTO rejected all the asserted claims based on Bisset(JX-196). (*See* JX-6.1407-25.) The applicants disagreed with the PTO (*id.* at 1454) in amendments to claims 1 and 10 (*id.* at 1456-57; and in written remarks. (*Id.* at 1468-72.) According to the applicants, the PTO’s interpretation was that “merely *obtaining* measured data is the same as *fitting an ellipse to* the data, so long as the measured data happens to be measured from an object that ‘is in general ellipse-like.’” *Id.* The applicants disagreed, explaining:

PUBLIC VERSION

[U]nder the plain meaning of the language of the claims, without more, one skilled in the art would not interpret “fitting an ellipse to at least one of the pixel groups in such a manner.” *Furthermore, the Office Action’s interpretation is particularly unreasonable when the claim language is viewed in light of the specification, as it must be viewed. In this regard, Applicants submit that the Office Action fails to consider the disclosure of the specification when interpreting at least the feature of “fitting an ellipse to at least one of the pixel groups.” . . .*

Nevertheless, claim 1 has been amended to recite *mathematically* fitting an ellipse to at least one of the pixel groups. . . . Claim 10 has been similarly amended.

(JX-6 at 1468-69 (emphasis added).) While this confirms (as the specification does) that claim language does require actually fitting an ellipse to the pixel group data, it does not limit the method of fitting to only the method disclosed in the specification. Accordingly, the ALJ finds that while the prosecution history provides further support to reject Apple’s extremely broad construction, the prosecution history does not limit the claims as narrowly as Motorola and Staff suggest.

Apple argues that its construction is not so broad as to encompass any computation of numerical parameters for fitting any shape. (CRB at 14.) Apple argues that there are two requirements of its construction: (1) the accused process must compute numerical parameters and (2) those parameters must mathematically define an ellipse. (CRB at 14.) This explanation further highlights the disjointedness of Apple’s construction. The first requirement of Apple’s construction is a non-limitation, because nearly any computer process will involve computation of numerical parameters. The second requirement turns the claim language on its head. Instead of “mathematically fitting” an ellipse *to* the pixel groups, as a person of ordinary skill would understand that term, Apple’s construction would reverse the process. A parameter, generated in any way possible that could be used *ex post* to generate an ellipse that could be fitted over the pixel groups would meet its construction. The claim language demands a different process,

PUBLIC VERSION

whereby a fitting procedure (such as the group covariance matrix method described in the specification) could be used to fit an ellipse to the pixel group from which ellipse parameters could be derived.

Apple also relies on the hearing testimony of Dr. Westerman in an effort to suggest that the methodology at the top of column 27 is a method of “mathematically fit(ting) an ellipse.” (CIB at 32.) The ALJ agrees with Staff and Motorola that testimony by the inventor that seeks to broaden the scope of the patent in litigation should be approached with great caution. *See N. Am. Vaccine, Inc. v. Am. Cyanamid Co.*, 7 F.3d 1571, 1577 (Fed. Cir. 1993) (“Where meaning of a claim term is clear from the specification and prosecution history, the inventor’s self-serving post-hoc opinion testimony on the legal question whether it should have a different meaning was of little if any significance.”). This caution seems especially true in this case because Dr. Westerman at times testified (consistent with the specification) that the methodology disclosed at the top of column 27 was an alternative to—not an example of—ellipse fitting. (Tr. 339:25-340:8.) Nevertheless, the named inventors did offer some helpful definitions at their depositions. (See RX-1895C at Q/A 447.) Specifically, when asked about what the term meant, Mr. John Elias, one of the two named inventors, testified:

Well, from a mathematical point of view or a [*sic.*] electrical engineering point of view, to fit an ellipse, as an example, to a collection of data points means that you want to find the parameters that describe that ellipse, such that it minimizes the differences between the ellipse, the model, and the data.

(RX-1895C at Q/A 447 (quoting Elias Dep. Tr. At 186-87).) This definition is most consistent with the common mathematical meaning of the term “fitting” used in a variety of similar contexts (most commonly in statistics). *See, e.g.*, Merriam Webster Dictionary ([http://www.merriam-webster.com/dictionary/curve fitting](http://www.merriam-webster.com/dictionary/curve%20fitting)) (defining “curve fitting” as “the empirical determination of a curve or function that approximates a set of data”) (last visited Dec.

PUBLIC VERSION

30, 2011); *ATA Airlines, Inc. v. Fed. Express Corp.*, --- F.3d ----, 2011 WL 6762865, at *8 (7th Cir. Dec. 30, 2011) (Posner, J.) (line fitting using “least squares”) (“[A] linear regression is an equation for the straight line that provides the best fit for the data being analyzed. The ‘best fit’ is the line that minimizes the sum of the squares of the vertical distance between each data point and the line.”); *Burlington N., Inc. v. United States*, 676 F.2d 566, 578 n.37 (Ct. Cl. 1982) (curve fitting using “least squares”) (noting the expert “used the mathematical ‘least squares’ method of analysis. More accurately this method is described as the least sum of the squared differences. It is a mathematical measure of the differences between the hypothesized line (the curve being fit) and the observed data for the purpose of determining how closely the hypothesized line describes the data.”). The ALJ does not consider any of these sources of extrinsic evidence to be controlling (although the ALJ does find Mr. Elias’s testimony informative), but most importantly they are not inconsistent with the understanding expressed in the specification and prosecution history discussed above.

In sum, the ALJ finds that neither the specification nor prosecution history limits the claims to only the group covariance method described in the specification. However, the ALJ does find that the plain meaning of the claims supported by the specification and prosecution history requires that an ellipse actually be fitted to the pixel groups. Thus, Apple’s construction that requires only that ellipse parameters be calculated without fitting an ellipse to the data cannot be correct. Accordingly, the ALJ construes the term “mathematically fit(ting) an ellipse to one or more pixel groups” to mean performing a mathematical process where by an ellipse is actually fitted to the data consisting of one or more pixel groups and from that ellipse various parameters can be calculated.

PUBLIC VERSION

2. “ellipse parameters” (claims 2, 11, 29)

Apple’s Proposed Constructions	Motorola’s Proposed Constructions	Staff’s Proposed Constructions
Plain and ordinary meaning, or: parameters that describe an ellipse	geometric parameters obtained from mathematically fitting an ellipse	Parameters that describe an ellipse, e.g. position, shape, size, orientation, eccentricity, major radius, minor radius.

Apple argues that this term should be given its plain and ordinary meaning or in the alternative, it should be defined as “parameters that describe an ellipse.” Motorola offered, in its pre-hearing brief, an alternative construction that effectively seeks to incorporate the “mathematically fitting” limitation that is the parties’ primary dispute. Motorola offered no arguments for its construction in its post-hearing brief, so those arguments are waived. The Staff argues that its definition is based on the common understanding of the parameters that define an ellipse as recognized by both parties and described in the ’828 Patent. (SIB at 14-15.) The Staff’s primary concern is that Apple seeks to include terms beyond the “classical parameters of an ellipse in order to encompass parameters derived by the Accused Products...” (SIB at 15.)

The ALJ agrees with Staff’s construction that the term should be given its plain and ordinary meaning, which is parameters that describe an ellipse, e.g., position, shape, size, orientation, eccentricity, major radius, minor radius.

3. “means for fitting an ellipse to at least one of the pixel groups” (claim 24)

Apple’s Proposed Constructions	Motorola’s Proposed Constructions	Staff’s Proposed Constructions
<p>§ 112 ¶ 6 function: computing numerical parameters that mathematically define an ellipse which approximates the shape of at least one of the pixel groups (as construed above)</p> <p>§ 112 ¶ 6 structure: a module that computes numerical parameters that mathematically define an ellipse which approximates the shape of at least one of the pixel groups using</p>	<p>This element is subject to 35 U.S.C. § 112 ¶ 6.</p> <p>Function: “fitting an ellipse to at least one of the pixel groups”</p> <p>Structure: Using a programmed host computer as described in 14:6-8, parameterizing the grouped pixel data in at least one of the pixel groups by (1) computing a</p>	<p>Function: fitting an ellipse to at least one of the pixel groups</p> <p>Structure: a computer that computes numerical parameters that mathematically define an ellipse which approximates the shape of at least one of the pixel groups using equations 12-21 or equivalents thereof.</p>

PUBLIC VERSION

Apple's Proposed Constructions	Motorola's Proposed Constructions	Staff's Proposed Constructions
one or more of equations 12-23 or equivalents. (25:62-26:65)	proximity-weighted centroid from positions and proximities of each pixel in a pixel group using equations 12-14 in the specification; (2) computing a group covariance matrix of x-y second moments using equations 15-18 of the specification; (3) after calculating the eigenvalues of the covariance matrix in equation 15, using these eigenvalues to determine axis lengths and orientation of an ellipse using equations 19-21 of the specification; and equivalents thereof.	

As the Staff explains, “[t]he main dispute regarding this term is the proper construction of the phrase “fitting an ellipse” as discussed previously . . . regarding the ‘mathematically fitting an ellipse’ limitation.” (SIB at 24.) Apple agrees. (CIB at 38-39.) Motorola offered no separate arguments regarding this term apart from its arguments regarding “mathematically fitting an ellipse.” (See RIB at 79-87.)

“When a claim uses the term ‘means’ to describe a limitation, a presumption inheres that the inventor used the term to invoke § 112, ¶ 6.” *Biomedino, LLC v. Waters Tech. Corp.*, 490 F.3d 946, 950 (Fed. Cir. 2007) (citing *Altiris, Inc. v. Symantec Corp.*, 318 F.3d 1363, 1375 (Fed. Cir. 2003)). “This presumption can be rebutted when the claim, in addition to the functional language, recites structure sufficient to perform the claimed function in its entirety.” *Id.* (quotation marks omitted). The parties agree and the ALJ finds that § 112 ¶ 6 applies to this claim term.

“Once a court concludes that a claim limitation is a means-plus-function limitation, two steps of claim construction remain: 1) the court must first identify the function of the limitation; and 2) the court must then look to the specification and identify the corresponding structure for

PUBLIC VERSION

that function.” *Id.* Apple defines the function as “computing numerical parameters that mathematically define an ellipse which approximates the shape of at least one of the pixel groups.” The Staff contends that the function is simply “fitting an ellipse to one or more pixel groups.” The ALJ is mindful that “[w]hen construing the functional statement in a means-plus-function limitation, we must take great care not to impermissibly limit the function by adopting a function different from that explicitly recited in the claim,” *Generation II Orthotics, Inc. v. Med. Tech., Inc.*, 263 F.3d 1356, 1364-65 (Fed. Cir. 2001), and that we must “stay[] true to the claim language and the limitations expressly recited by the claim[,]” *Omega Eng’g, Inc. v. Raytek Corp.*, 334 F.3d 1314, 1321 (Fed. Cir. 2003). The ALJ sees no reason to indulge in re-writing the claims when the function is clear from the claim language itself. The identified function does not impermissibly narrow the claims, but neither does it impermissibly broaden the claims. Apple’s function would substantially broaden the claim by eliminating the “fitting” requirement recited in all of the claims. As set forth *supra*, this requirement was essential for obtaining allowance of the patent. (See Section IV.C.1.) Accordingly, the ALJ finds that the function is “fitting an ellipse to at least one of the pixel groups.”

As for the corresponding structure, Apple proposes a structure of “a module that computes numerical parameters that mathematically define an ellipse which approximates the shape of at least one of the pixel groups using one or more of equations 12-23 or equivalents.” (CIB at 37-38.) The Staff defines the structure as “a computer that computes numerical parameters that mathematically define an ellipse which approximates the shape of at least one of the pixel groups using equations 12-21 or equivalents thereof.” (SIB at 23-25.) The ALJ perceives two main disputes. The first is whether the program is running on a “module,” a

PUBLIC VERSION

“computer,” or a “host computer.” Second, whether equations 22-23 should be included in the structure.

Regardless of what a “module” is precisely, the ALJ sees no distinction (at least of any importance to this case) between defining the structure as a “computer” versus a “module.”

As for the equations that should included in the structure, the ALJ agrees with Staff that equations 22-23 should not be included. There is simply no link between those equations and “fitting an ellipse.” As discussed above, those equations represent an alternative to fitting an ellipse. (*See supra* at IV.C.1.) Accordingly, the ALJ finds the structure limited as the Staff suggests.

4. “proximity” and “electrode” terms

Claim Term	Apple’s Proposed Constructions	Motorola’s Proposed Constructions	Staff’s Proposed Constructions
“proximity” (claims 1, 10)	the distance or pressure between an object (such as a finger) and a touch-sensitive surface	the distance or pressure between a touch object and the touch-sensitive surface	distance or pressure between the touch device such as a finger and a surface
“proximity image representing a scan of a plurality of electrodes” (claims 1, 24)	a proximity image where the data corresponds to signals from a plurality of electrodes	a two-dimensional pixilated image corresponding to a two-dimensional array of pixilated electrodes wherein each pixel represents self-capacitance measured at a single electrode during a particular scan cycle	a proximity image where the data corresponds to signals from a plurality of electrodes
“proximity image” (claims 1, 10, 24)	an array of proximity data	see “proximity image representing a scan of a plurality of electrodes”	an array of proximity data
“a plurality of touch-sensing electrodes arranged on the substrate” (claim 10)	multiple electrically conductive elements arranged on the substrate that can sense the distance or pressure between the conductive elements and objects on or near the conductive elements	an array of pixilated self-capacitance sensing electrodes arranged on a surface	multiple electrodes arranged on the substrate that can sense the distance or pressure between the conductive elements and touch objects on or near the conductive elements

PUBLIC VERSION

These terms have been grouped together by Apple and they all raise related issues regarding the electrodes of the touch surface, so the ALJ will consider them together. The parties have proposed slightly different constructions for “proximity” in the ’828 Patent. The term “proximity” is explicitly defined in the ’828 Patent specification, and all of the parties’ proposed constructions are based on this explicit definition:

The term “proximity” will only be used in reference to the distance or pressure between a touch device such as a finger and the surface 2, not in reference to the distance between adjacent fingers.

(JX-3 at 14:22-25.) The ’828 Patent describes “surface 2” as “the multi-touch surface 2.” (JX-3 at 12:67-13:1.) The Staff argues that its construction is correct because the claimed “proximity” is not between any object and the surface; rather, it is between a touch object (that is, a conducting touch object) and the touch-sensitive surface. (SIB at 28.) The ALJ finds that there are no significant differences between the three proposed constructions. The ALJ finds that Staff’s definition best harmonizes the explicit definition in the specification with the requirement that the distance be between the touch object and the touch-sensitive surface. Accordingly, the ALJ adopts the Staff’s basic construction (with some slight tweaks for greater clarity) and defines the term “proximity” as “the distance or pressure between the touch device (such as a finger) and the touch-sensitive surface.”

The second term of this group is “proximity image.” Apple and Staff argue that this should be construed as “an array of proximity data.” Motorola argued previously that this term should mean “a two-dimensional pixilated image corresponding to a two-dimensional array of pixilated electrodes wherein each pixel represents self-capacitance measured at a single electrode during a particular scan cycle.” The primary dispute between the parties is Motorola’s effort to read in the “self-capacitance” limitation from its “electrode” construction (hence why these terms

PUBLIC VERSION

are grouped together). Motorola offered no arguments on this particular term although it continues to argue for the self-capacitance limitation in the “a plurality of touch-sensing electrodes arranged on the substrate” limitation of claim 10. The claim language and specification in no way limits the term “proximity image” to only self-capacitance measurements. (See JX-3 at 6:22-49.) Thus, the ALJ finds that Motorola is improperly trying to limit “proximity image” by incorporating a limitation that simply doesn’t belong there. Accordingly, the ALJ finds that “proximity image” means an array of proximity data.

The third term “proximity image representing a scan of a plurality of electrodes” involves the same dispute as “proximity image.” As with that claim term, the ALJ rejects Motorola’s efforts to read self-capacitance into the claim term. Accordingly, the ALJ adopts Apple’s and Staff’s construction for this term, namely a proximity image where the data corresponds to signals from a plurality of electrodes.

The final term is “a plurality of touch-sensing electrodes arranged on the substrate.” Apple and Staff argue that this term should be construed as “multiple electrodes arranged on the substrate that can sense the distance or pressure between the conductive elements and touch objects on or near the conductive elements.” (CIB at 47-48; SIB at 16-17.) Motorola proposes a construction of “an array of pixelated self-capacitance sensing electrodes arranged on a surface.” (RIB at 87-89.)

Apple argues that “Motorola [*sic.*] proposed construction[] . . . ignore[s] the plain language of the disputed terms” and that “Motorola’s proposed construction would restrict this claim to the pixelated self-capacitance electrodes described in the specification and would exclude so-called ‘row and column’ electrodes.” (CIB at 40.) According to Apple, “[t]his is not consistent with the use of the general terms ‘electrode’ in the claims, however, which is used

PUBLIC VERSION

throughout the patent to refer to different types of electrodes that existed in the prior art, including row and column electrodes.” (CIB at 40.) Similarly, Staff argues that Motorola is “attempting to read a self-capacitance requirement into the limitation” and that “the ’828 Patent’s specification recognizes that electrodes may have either self or mutual capacitance, and specifically notes when an electrodes is limited to one or the other.” (SIB at 17.)

Motorola responds by pointing to the “Background” section in the specification that describes the problems confronting the inventors. Motorola argues that the specification distinguishes “mutual capacitance devices from “the present invention” noting that in the prior art there are devices which “measure the mutual capacitance between row and column electrodes by driving one set of electrodes at one frequency and sensing how much of that frequency is coupled onto a second electrode set.” (RIB at 88 (quoting JX-3 at 5:1-5).) Motorola argues that the specification then asserts that “there exists a need in the art for a capacitance-sensing apparatus which does not suffer from poor signal-to-noise ratio and the multiple finger indistinguishability problems of touchpads with long row and column electrodes.” (RIB at 88 (quoting JX-3 at 5:40-43).) Motorola argues that the “Summary of Invention” section then provides the named inventors’ solution:

To achieve the objects and in accordance with the purpose of the invention, as embodied and broadly described herein, ***the invention comprises*** a sensing device that is sensitive to changes in ***self-capacitance*** brought about by changes in proximity of a touch device to the sensing device, the sensing device comprising: two electrical switching means connected together in series having a common node, an input node, and an output node; a dielectric-covered sensing electrode connected to the common node between the two switching means; a power supply providing an approximately constant voltage connected to the input node of the series-connected switching means; an integrating capacitor to accumulate charge transferred during multiple consecutive switchings of the series connected switching means; another switching means connected in parallel across the integrating capacitor to deplete its residual charge; and a voltage-to-voltage translation device connected to the output node of the series-connected switching means which produces a voltage

PUBLIC VERSION

representing the magnitude of the self-capacitance of the sensing device. Alternatively, the sensing device comprises: two electrical switching means connected together in series having a common node, an input node, and an output node; a dielectric-covered sensing electrode connected to the common node between the two switching means; a power supply providing an approximately constant voltage connected to the input node of the series-connected switching means; and an integrating current-to-voltage translation device connected to the output node of the series connected switching means, the current-to-voltage translation device producing a voltage representing the magnitude of the *self-capacitance* of the sensing device.

(JX-3 at 7:54-8:17 (emphasis added).) Motorola argues that “[b]y stating that ‘*the invention comprises* a sensing device that is sensitive to changes in self-capacitance’ in the ‘Summary of Invention’ section, the specification of the ’828 Patent indicates that ‘a sensing device that is sensitive to changes in self-capacitance’ is not simply a potential embodiment, but a limitation of the ‘touch-sensing device’ of claim 10.” (RIB at 89.) Motorola argues there is a line of cases that hold when the specification describes features as the “present invention” or the “invention,” then it limits the claims. (See RIB at 89 (citing *Cook Biotech Inc. v. Acell, Inc.*, 460 F.3d 1365, 1374 (Fed. Cir. 2006) (by using “the present invention comprises,” the “specification indicate[d] [that] the composition was defined” in a particular way); *TiVo, Inc. v. Echostar Commc’ns Corp.*, 516 F.3d 1290, 1300 (Fed. Cir. 2008) (“[W]hen a patent thus describes the features of the ‘present invention’ as a whole, this limits the scope of the invention.”); *SciMed Life Sys., Inc. v. Advanced Cardiovascular*, 242 F.3d 1337, 1342-43 (Fed. Cir. 2001) (“[T]he written description supports the district court’s conclusion that the claims should not be read so broadly as to encompass the distinguished prior art structure [T]he characterization of the coaxial configuration as part of the ‘present invention’ [in the ‘Summary of the Invention’] is strong evidence that the claims should not be read to encompass the opposite structure.”)).)

This dispute requires the ALJ to determine the effect of the use of the language “this

PUBLIC VERSION

invention” (or the “the present invention”) in the specification on the scope of the claims. The parties do not dispute that the term “plurality of . . . electrodes . . .” by itself is not limited to self-capacitance, but dispute whether, read in light of the specification, this term should be so limited. The recent case of *Retractable Technologies, Inc. v. Becton, Dickinson & Co.*, 653 F.3d 1293 (Fed. Cir. 2011) is instructive. In that case, the claims involved claims directed to retractable syringes. The disputed limitation was the term “body,” which the parties agreed could include a multi-piece body or single piece body, but the defendant argued that, in light of the specification, the term was limited to only single piece bodies. The district court disagreed and interpreted the term “body” broadly to encompass both possibilities. The Federal Circuit reversed this claim construction finding that, in light of the specification, the claims were limited to a single piece body. Specifically, the Federal Circuit noted that:

The specifications indicate that the claimed “body” refers to a one-piece body. In distinguishing prior art syringes comprised of multiple pieces, the specifications state that the prior art had failed to recognize a retractable syringe that “can be molded as one piece outer body.” . . . Consistent with this characterization of the prior art, the Summary of the Invention states that “[t]he invention is a retractable tamperproof syringe,” and that this syringe “features a one piece hollow body.”

Similarly, the specifications, in describing the invention, expressly state that each syringe embodiment contains a one-piece body. . . . In addition, each figure that depicts a syringe body shows a one-piece body. In contrast, the specifications do not disclose a body that consists of multiple pieces or indicate that the body is anything other than a one-piece body.

Retractable Tech., 653 F.3d at 1305.

The ALJ finds that this is a close call in this investigation. The specification does repeatedly describe the “invention” as using “self-capacitance” electrodes. However, the ALJ finds that the evidence in this case is simply not as strong as that in *Retractable Technologies* to limit the plain language of the claims to only self-capacitance. In particular, the ALJ notes that the discussion of prior art discusses both self and mutual capacitance embodiments and there

PUBLIC VERSION

does not appear to be any distinction drawn between self-capacitance and any other technology in the prior art that would lead a person of ordinary skill to believe that the invention was limited only to “self-capacitance” embodiments. (See JX-3 at 5:1-57.) Accordingly, the ALJ rejects Motorola’s construction. The ALJ finds that “a plurality of touch-sensing electrodes arranged on the substrate” means multiple electrical elements arranged on the substrate that can sense the distance or pressure between the electrical elements and objects on or near the electrical elements.

5. “a calibration module operatively coupled to the electronic scanning hardware and adapted to construct a proximity image having a plurality of pixels corresponding to the touch-sensing electrodes” (claim 10)

Apple’s Proposed Constructions	Motorola’s Proposed Constructions	Staff’s Proposed Constructions
a module that receives data from the electronic scanning hardware, which corrects for background noise and constructs a proximity image having multiple pixels with proximity data that corresponds to signals from the touch-sensing electrodes	hardware module electrically connected to scanning circuitry for creating a proximity image having a plurality of pixels corresponding to the touch-sensing electrodes	Module, which is indirectly or directly electrically connected to scanning circuitry, that constructs a proximity image having multiple pixels from a scan of the touch-sensing electrodes and that subtracts off any background noise

Apple and Staff offer very similar constructions. The principal dispute between them is whether the claim term is limited to a particular method of correcting for background noise or not. (CIB at 47; SIB at 18-19.) The Staff points to the specification as support where it teaches the use of only subtracting the background noise as the method for removing background noise. (See JX-3 at 13:10-13 (“calibration module 8 constructs a raw proximity image from a complete scan of the sensor array and subtracts off any background sensor offsets”); *id.* at 14:40-44 (“[i]t is desirable to remove this non-zero background signal before converting the sensor output 58 to

PUBLIC VERSION

a digital code. This is done by using a differential amplifier 64 to subtract a stored record of the background signal 68 from the sensor output 58.”.) Apple makes no arguments regarding this point.

The ALJ finds that Staff’s construction is correct. The specification consistently describes the calibration module as a module that “subtracts off any background sensor offsets.” (JX-3 at 14:40-44.) Apple points to no specification support for its construction. Accordingly, the ALJ finds that “a calibration module operatively coupled to the electronic scanning hardware and adapted to construct a proximity image having a plurality of pixels corresponding to the touch-sensing electrodes” means a module, which is indirectly or directly electrically connected to scanning circuitry, that constructs a proximity image having multiple pixels from a scan of the touch-sensing electrodes and that subtracts off any background noise.

6. “each pixel group representing proximity of a distinguishable hand part or other touch object” (claim 1, 10)

Apple’s Proposed Constructions	Motorola’s Proposed Constructions	Staff’s Proposed Constructions
each pixel group representing the distance or pressure between the touch-sensitive surface and a different part of a hand or other touch object	each pixel group representing proximity of a specific hand part such as a thumb, fingertip, or palm that can be assigned a specific hand and finger identity so that hand configurations and motions can be distinguished	Each pixel group representing the distance or pressure between the touch-sensitive surface and a distinguishable part of a hand or other touch object

Apple and Staff agree that the term “each pixel group representing proximity of a distinguishable hand part or other touch object” of independent claims 1 and 10 means “each pixel group representing the distance or pressure between the touch-sensitive surface and a different part of a hand or other touch object.” Motorola argued in its pre-hearing brief that this

PUBLIC VERSION

term should be construed to mean “each pixel group representing proximity of a specific hand part such as a thumb, fingertip, or palm that can be assigned a specific hand and finger identity so that hand configurations and motions can be distinguished.” Apple and Staff argue that their construction is correct because it comports with the description of this limitation in the specification (*See* CIB at 45; SIB at 10 (citing JX-3 at 8:53-63, 17:21-29, 23:8-25:2).) Motorola offered no arguments regarding this term in its post-hearing brief. (*See* RIB at 79-89.) Staff argues that “distinguishing different hand parts as Motorola proposes is specifically claimed in dependent claims 4 and 14, which depend from Claim 1.” (SIB at 10 (citing JX-003 at 60:23-25; 61:13-15; 19:2-5; 23:15-19).) Apple agrees with this argument. (CIB at 45.)

The ALJ finds that Apple’s and Staff’s construction of this term most comports with the plain and ordinary meaning of this term. It is consistent with the specification and the the claim language, and the dependent claims. Accordingly, the term “each pixel group representing proximity of a distinguishable hand part or other touch object” of independent claims 1 and 10 means each pixel group representing the distance or pressure between the touch-sensitive surface and a different part of a hand or other touch object.

7. “contact tracking and identification module” (claim 10)

Apple’s Proposed Constructions	Motorola’s Proposed Constructions	Staff’s Proposed Constructions
a module that can identify and track data that represents an object (such as a finger)	software or circuitry that uniquely identifies each individual hand part as it moves through successive images by mathematically fitting one or more ellipses and using the geometric parameters of these ellipses to specifically identify individual fingers, thumbs, and other distinguishable portions of a hand	a module that can identify and track data that represents an object (such as a finger)

PUBLIC VERSION

Apple and Staff agree on the construction of this term as “a module that can identify and track data that represents an object (such as a finger).” Motorola sought a more complicated definition that sought to read in limitations from other parts of the claim into this claim term. Motorola did not present any arguments in support of its construction in its post-hearing brief.

As Apple and the Staff point out, the '828 Patent specification explicitly describes “contact tracking and identification module 10, which segments the image into distinguishable hand-surface contacts, tracks and identifies them as they move through successive images.” (CIB at 48; SIB at 19-20 (both citing JX-3 at 13:15-19).) Thus, the ALJ finds that Apple and Staff’s construction is consistent with the specification and adopts it.

8. “means for producing a proximity image representing a scan of a plurality of electrodes of a touch-sensitive surface, the proximity image having a plurality of pixels corresponding to the touch-sensing electrodes” (claim 24)

Apple’s Proposed Constructions	Motorola’s Proposed Constructions	Staff’s Proposed Constructions
<p>§ 112 ¶ 6 function: producing an array of proximity data representing a scan of multiple electrical elements of a surface that can sense the distance or pressure between the surface and objects on or near the surface</p> <p>§ 112 ¶ 6 structure: circuitry that scans an array of proximity sensors 47 and converts the proximity sensor output 58 to a digital code appropriate for digital processing or an equivalent. (16:4-53)</p>	<p>This element is subject to 35 U.S.C. § 112 ¶ 6.</p> <p>Function: “producing a proximity image representing a scan of a plurality of electrodes of a touch-sensitive surface, the proximity image having a plurality of pixels corresponding to the touch-sensing electrodes”</p> <p>Structure: Circuitry that constructs and outputs a proximity image including: (1) a proximity sensing device that measures self-</p>	<p>Function: producing a proximity image representing a scan of a plurality of electrodes of a touch-sensitive surface</p> <p>Structure: circuitry that scans an array of proximity sensors 47 and converts the proximity sensor output 58 to a code appropriate for digital processing as in Figures 7A and 7B or equivalents thereof</p>

PUBLIC VERSION

Apple's Proposed Constructions	Motorola's Proposed Constructions	Staff's Proposed Constructions
	capacitance of one or more pixelated sensing electrodes, as in figs. 2-6; and (2) circuitry that converts each signal from the proximity sensing device to a digital code appropriate for processing by computer by using digital-to-analog converter to convert a digital stored background signal value to a voltage, using a differential amplifier to subtract that background signal from the proximity sensing device signal, and then converting this difference signal to digital code using an analog to digital converter, as in figs. 7A and 7B; and equivalents thereof.	

The parties agree that this term is subject to 35 U.S.C. § 112 ¶ 6. Apple and Staff largely agree on the function. The only difference between them appears to be that Apple replaced a number of terms in the Staff's function (e.g., "proximity image" and "plurality of electrodes of a touch-sensitive surface") with the claim construction for that term. Motorola's construction of the claimed function in its pre-hearing brief includes a sub-clause from the claim "the proximity image having a plurality of pixels corresponding to the touch-sensing electrodes." Motorola included no argument in its post-hearing brief regarding this claim element. (See RIB at 79-90.)

The ALJ finds that the Staff's description of the function of this element is the correct one. Apple's proposed function simply inserts the definitions for the claim terms and such an exercise is unnecessary because those terms have been separately defined. Therefore, the function is producing a proximity image representing a scan of a plurality of electrodes of a

PUBLIC VERSION

touch-sensitive surface.

The main dispute between the parties regarding the structure is whether the array must be limited to a self-capacitance array. As discussed above (and for the exact same reasons), the ALJ declined to incorporate such a limitation. (See Section IV.C.4.) The parties largely agree on the remainder of the structure as set forth in Figures 5-7 and the corresponding text, see 16:4-53, and equivalents thereof.

9. “segment(ing)” terms

Claim Term	Apple’s Proposed Constructions	Motorola’s Proposed Constructions	Staff’s Proposed Constructions
“segmenting each proximity image into one or more pixel groups that indicate significant proximity” (claim 1)	collecting pixels in each proximity image into one or more pixel groups that are identified by their proximity values	plain and ordinary meaning	Collecting pixels in each proximity image into one or more pixel groups that are identified by their proximity values
“segment the proximity image into one or more pixel groups” (claim 10)	collect pixels in each proximity image into one or more pixel groups	plain and ordinary meaning	Collecting pixels in each proximity image into one or more pixel groups

Apple and Staff agree on the definition of these terms. Motorola contended in its pre-hearing brief that the construction should be the plain and ordinary meaning, but offered no arguments in its post-hearing brief. (See RIB at 79-90.)

The ALJ discerns no real difference or significance between these constructions. However, the ALJ finds that Apple’s and Staff’s construction does represent the plain and ordinary meaning and are consistent with the specification. The ALJ, therefore, adopts their constructions for these two terms. Accordingly, “segmenting each proximity image into one or more pixel groups that indicate significant proximity” means collecting pixels in each proximity

PUBLIC VERSION

image into one or more pixel groups that are identified by their proximity values and “segment the proximity image into one or more pixel groups” means collecting pixels in each proximity image into one or more pixel groups.

10. “means for segmenting the proximity image into one or more pixel groups, each pixel group representing a touch object on or near the touch-sensitive surface” (claim 24)

Apple’s Proposed Constructions	Motorola’s Proposed Constructions	Staff’s Proposed Constructions
<p>§ 112 ¶ 6 function: collecting pixels in each proximity image into one or more pixel groups (as construed above)</p> <p>§ 112 ¶ 6 structure: a module that collects pixels in the proximity image into pixel groups using process 268 or an equivalent. (23:8-40)</p>	<p>This element is subject to 35 U.S.C. § 112 ¶ 6.</p> <p>Function: “segmenting the proximity image into one or more pixel groups, each pixel group representing a touch object on or near the touch-sensitive surface”</p> <p>Structure: A host computer programmed to perform the steps diagrammed in figure 18 and equivalents thereof.</p>	<p>Function: segmenting the proximity image into one or more pixel groups</p> <p>Structure: a computer programmed to perform the steps diagrammed in Fig. 18 and equivalents thereof</p>

The parties agree that this term is subject to 35 U.S.C. § 112 ¶ 6. The parties also agree that the function is “segmenting,” but Apple seeks to define the function further by inserting the definition for the “segmenting” term into the function. The ALJ finds that there is no need to insert the definition for “segmenting” into the function because the claim language is clear. The ALJ finds that the function for this term is “segmenting the proximity image into one or more pixel groups.”

As for the corresponding structure, Staff and Motorola contend that the corresponding structure is “a computer programmed to perform the steps diagrammed in Figure 18 and

PUBLIC VERSION

equivalents thereof.”⁵ Apple argues that Figure 18 is overinclusive because some of the steps (such as the smoothing step) are not part of segmenting. (CIB at 46.) The ALJ finds that the appropriate structure is Figure 18 and equivalents thereof. The specification clearly links Figure 18 to the segmenting means stating: “FIG. 18 represents the data flow within the proximity image segmentation process 241.” (JX-3 at 23:8-9.) As the specification explains, “[t]he image segmentation process 241 takes the most recently scanned proximity image data 240 and segments it into groups of electrodes 242 corresponding to the distinguishable hand parts of FIG. 13.” (JX-3 at 19:2-5.) Thus, “Image Segmentation” is linked to the claimed “segmenting” function and Figure 18 outlines the steps the computer must be programmed to perform that function. Accordingly, the ALJ finds that the appropriate structure is Figure 18 and equivalents thereof.

11. “transmitting one or more ellipse parameters as a control signal to an electronic or electromechanical device” (claim 2)/“transmit one or more ellipse parameters as a control signal to an electronic or electromechanical device” (claim 11)

Claim Term	Apple’s Proposed Constructions	Motorola’s Proposed Constructions	Staff’s Proposed Constructions
“transmitting one or more ellipse parameters as a control signal to an electronic or electromechanical device” (claim 2) “transmit one or more ellipse parameters as a control signal to an electronic or	Plain and ordinary meaning, or: transmit(ing) one or more ellipse parameters as a signal that can be used to control some aspect of an electronic or electromechanical device	<i>plain and ordinary meaning</i> , subject to Motorola’s proposed construction for “ellipse parameters”	Transmitting one or more ellipse parameters as a signal that can be used to control some aspect of an electronic or electromechanical device

⁵ Motorola sought to further limit the term to “host computer.” Motorola never raised this in its post-hearing briefs. However, even if this argument was considered, it is improper to limit computer to a “host computer” as discussed above. (See Section IV.C.3.)

PUBLIC VERSION

Claim Term	Apple's Proposed Constructions	Motorola's Proposed Constructions	Staff's Proposed Constructions
electromechanical device" (claim 11)			

The parties do not appear to dispute this term. Motorola has offered a construction that is "subject to" its proposed construction for "ellipse parameters." The Staff offers a slightly reworded version of the claim language. The ALJ finds this language plain on its face and that there is no significant difference between the Staff's proposed construction and the actual claim language. Accordingly, the ALJ finds there is no construction necessary of this term and adopts the plain and ordinary meaning of this claim term as the construction.

12. "means for transmitting one or more ellipse parameters as a control signal to an electronic or electromechanical device" (claim 29)

Apple's Proposed Constructions	Motorola's Proposed Constructions	Staff's Proposed Constructions
<p>§ 112 ¶ 6 function: transmitting one or more ellipse parameters as a signal that can be used to control some aspect of an electronic or electromechanical device (as construed above)</p> <p>§ 112 ¶ 6 structure: host communication interface 20 or an equivalent (13:63-14:15)</p>	<p>This element is subject to 35 U.S.C. § 112 ¶ 6.</p> <p>Function: "transmitting one or more ellipse parameters as a control signal to an electronic or electromechanical device"</p> <p>Structure: Indefinite. There is no structure that performs the claimed function."</p>	<p>Function: transmitting one or more ellipse parameters as a control signal to an electronic or electromechanical device</p> <p>Structure: host communication interface 20 or equivalents thereof</p>

The parties agree that this term is subject to 35 U.S.C. § 112 ¶ 6. Motorola and Staff agree on the function. Apple offers a slightly re-worded version of the claim language. There is no apparent significance to the different functions offered. Accordingly, the ALJ finds that the claim language is clear and construes the function as "transmitting one or more ellipse parameters as a control signal to an electronic or electromechanical device." As for the

PUBLIC VERSION

associated structure, Apple and Staff agree that the corresponding structure is the “host communication interface 20 or equivalents thereof.” Thus, the ALJ finds that the corresponding structure is the host communication interface 20 (JX-3 at 13:63-14:15) or equivalents thereof.

13. “Adapted to”

Claim Term	Apple’s Proposed Constructions	Motorola’s Proposed Constructions	Staff’s Proposed Constructions
“adapted to” (claim 11)	Plain and ordinary meaning, or: configured to	made suitable for	Made suitable for, configured to

As the Staff explained, the parties appear to be offering constructions of the term “adapted to” that differ in wording, but not in substance. (SIB at 29.) The Staff argues that its construction should be adopted because it comports with the plain meaning of the term, and incorporates the definitions offered by both the private parties. The ALJ agrees. Accordingly, the ALJ adopts the Staff’s construction of “adapted to” meaning “made suitable for, configured to.”

D. The ‘607 Patent⁶

1. “electrically isolated” (claims 1-7)

Apple	Motorola	Staff
Separated to prevent any significant current flow between the lines	Physically separated, electrically and mechanically	Separated to prevent any significant current flow between the lines

Apple and Staff argue that “electrically isolated” should be construed to mean “separated to prevent any significant current flow between the lines.” (CIB at 99; SIB at 50-51.) Motorola

⁶ Respondents argue that “capacitive monitoring circuitry” requires construction (RIB at 19-20) while Apple and Staff argue that the term does not need construction as no issue of infringement, validity or domestic industry turns on this issue. (CIB at 107; SIB at 52-53.) The ALJ agrees that this claim term need not be construed. *See Vanderlande*, 366 F.3d at 1323. Indeed, the parties’ claim constructions are quite similar. In addition, throughout Respondents’ brief, it is clear that issues surrounding this claim term are whether the circuitry identified by Apple in the ‘607 Accused Products and in the domestic industry product actually satisfy this limitation (under either construction) and are not dependent on the actual construction of this claim term.

PUBLIC VERSION

argues that it should be construed to mean “physically separated, electrically and mechanically.” (RIB at 14-16.) Motorola argues that its construction is supported by the specification and is consistent with the IEEE Standard Dictionary of Electrical and Electronics Terms from 1996. (RIB at 15.) Motorola further argues that Apple’s and Staff’s construction introduces uncertainty and, further, it is unclear what “significant” means. (RIB at 15-16.)

The ALJ finds that “electrically isolated” means separated to prevent any significant current flow between the lines. The specification repeatedly describes instances where the lines are separated enough to prevent significant current flow between the lines. (See ‘607 Patent at 9:22-10:21; 13:7-14:59; 15:7-15; 16:50-17:47.) Similarly, Figures 6, 7, 8, 10, 11, 18 and 19 show that “electrical isolation” in the ‘607 Patent does not require physical, electrical and mechanical separation. (‘607 Patent, Figs. 6, 7, 8, 10, 11, 18 and 19 and accompanying text.) Furthermore, the evidence shows that one of ordinary skill in the art would understand that complete isolation is not required and, further, would not be feasible in the real world as there will always be some degree of coupling between lines. (CX-202C at Q&A 91.)

The ALJ finds nothing in the ‘607 Patent specification that supports complete isolation as required by Motorola. Indeed, the portions of the specification cited by Motorola simply show that the conductive lines should be separated (indeed separated enough to prevent significant current flow), but fail to show the complete isolation proposed by Motorola.

Therefore, the ALJ finds that “electrically isolated” means separated to prevent any significant current flow between the lines.

2. “operatively coupled”

Apple	Motorola	Staff
Directly or indirectly electrically connected	Electrically connected	Directly or indirectly electrically connected

PUBLIC VERSION

Apple and Staff argue that “operatively coupled” should mean “directly or indirectly electrically connected.” (CIB at 106; SIB at 52.) Motorola argues that it means “electrically connected.” (RIB at 18.) Motorola argues that its claim construction is supported by the prosecution history and the understanding of one of ordinary skill in the art. (RIB at 16-18.) Motorola further argues that Apple’s and Staff’s proposed construction removes any distinction between drive lines and sense lines and is unsupported by the intrinsic evidence and general understanding of “operatively coupled.” (RIB at 18.)

The ALJ finds that “operatively coupled” means directly or indirectly electrically connected. The specification repeatedly uses “operatively coupled” or “coupled” to describe direct and indirect electrical connections. For example, in describing Figure 5, the ’607 Patent uses “operatively coupled” to describe direct and indirect connections:

In most cases, the processor 56 together with an operating system operates to execute computer code and produce and use data. The computer code and data may reside within a program storage block 58 that is operatively coupled to the processor 56.

* * *

The computer system 50 also includes a touch screen 70 that is operatively coupled to the processor 56.

PUBLIC VERSION

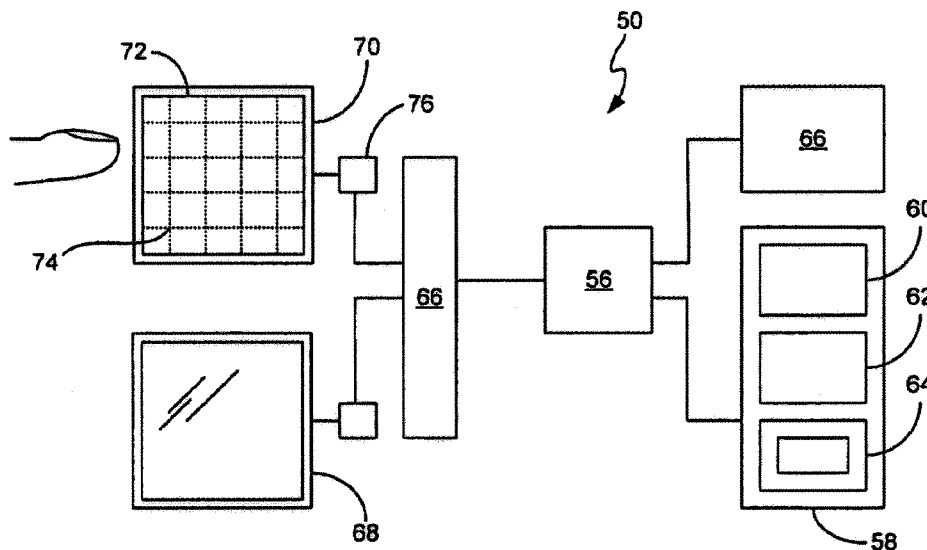

FIG. 5

(’607 Patent at 7:9-14, 53-54, Figure 5; *see also* 2:50-67; 6:26-39; 9:22-65; 10:47-58; 13:7-14:11; 17:12-35; 14:48-61; 18:11-39 and 29:32-47; Figures 14, 18 and 19 and accompanying text.) While Motorola’s construction could include indirect electrical connections, the ALJ finds that Apple’s and Staff’s construction more accurately reflects the meaning of “operatively connected” as used in the ’607 Patent.

Therefore, the ALJ finds that “operatively connected” means directly or indirectly electrically connected.

3. “Glass member”

Apple	Motorola	Staff
Glass or plastic element	A member made of glass	Glass or plastic element

Apple and Staff argue that “glass member” should be construed to mean a “glass or plastic element.” (CIB at 113; SIB at 54-55.) Motorola argues that it means “a member made of glass.” (RIB at 34.) Motorola argues that throughout the ’607 Patent, the use of “glass member”

PUBLIC VERSION

is limited to “glass” except for one instance, but that this instance is insufficient to redefine “glass member” to mean anything but a member made of glass.

The ALJ finds that “glass member” means glass or plastic element. The specification specifically states

Furthermore, each of the layers may be formed with various materials. By way fo example, each particular type of layer may be formed from the same or different material. **For example, any suitable glass or plastic material may be used for the glass members.**

(’607 Patent at 16:43-47) (emphasis added). Motorola argues that this is insufficient “to completely redefine a term as simple and non-technical as ‘glass member’ to a person of ordinary skill in the art.” (RIB at 35.) The ALJ finds Motorola’s argument unpersuasive as it fails to cite any evidence or legal precedence to support its argument. The specification explicitly states that the glass member may be composed of glass or plastic material. Therefore, the ALJ finds that “glass member” means a glass or plastic element.

E. The ’430 Patent

1. “dynamically adding support for hardware or software components with one or more properties” (Claim 1)

Claim Term	Apple’s Proposed Construction	Motorola’s Proposed Construction	Staff’s Proposed Construction
“dynamically adding support for hardware or software components with one or more properties”	The preamble is not limiting.	adding hardware or software components with one or more properties without running an installation program	adding support for hardware or software components to a computer system without running an installation program

Apple argues that the preamble of Claim 1 should not be limiting. Apple further argues that even if the preamble is limiting, Motorola’s construction is incorrect because “dynamically” does not require that the adding support occur “without running an installation program.” (CIB at 157-159.) Motorola and Staff argue that the preamble is limiting. Motorola and Staff offer

PUBLIC VERSION

slightly different, but essentially similar, definitions for the preamble. (RIB at 128-134; SIB at 98-101.)

Apple argues that “[t]he preamble of claim 1 is a classic example of a set-up to the actual limitations, setting the stage for the claim without adding a separate meaningful limitation.” (CIB at 157; CRB at 57.) And that “[w]here the preamble describes the purpose or use of the invention, there is a presumption that this description is not an independent claim limitation.” (CIB at 157.) It argues that “[t]he phrase ‘dynamically adding support’ in the preamble summarizes the four-step method of the claim rather than proving a whole new limitation.” Apple further argues that “[t]he four steps of the claim set for the actual limitations of what it means to add support ‘dynamically’—the operating system is queried for properties, and the result is the addition of support for the components ‘without rebooting the operating system.’” (CIB at 157.) Apple further argues that Motorola’s arguments fail as a matter of law because (1) “Federal Circuit law is clear that amendment to the preamble may be limiting only in the narrow circumstances where there was reliance on the preamble to overcome prior art” and (2) “the Federal Circuit has directed only where there is ‘dependence on *a particular disputed preamble phrase for antecedent basis* may the preamble limit claim scope.” (CIB at 158-59 (emphasis in the original).)

“Whether to treat a preamble term as a claim limitation is ‘determined on the facts of each case in light of the claim as a whole and the invention described in the patent.’” *Am. Med. Sys., Inc. v. Biolitec, Inc.*, 618 F.3d 1354, 1358 (Fed. Cir. 2010) (quoting *Storage Tech. Corp. v. Cisco Sys., Inc.*, 329 F.3d 823, 831 (Fed. Cir. 2003)). “[T]here is no simple test for determining when a preamble limits claim scope[.]” *Id.* “Generally, the preamble does not limit the claims.” *Allen Eng’g Corp. v. Bartell Indus., Inc.*, 299 F.3d 1336, 1346 (Fed. Cir. 2002). “Nonetheless,

PUBLIC VERSION

the preamble may be construed as limiting “if it recites essential structure or steps, or if it is necessary to give life, meaning, and vitality to the claim.” *Am. Med. Sys.*, 618 F.3d at 1358 (quoting *Catalina Mktg. Int'l, Inc. v. Coolsavings.com, Inc.*, 289 F.3d 801, 808 (Fed. Cir. 2002) (internal quotation marks omitted)).

The ALJ finds that the preamble is not limiting in this case. There are several factors that contribute to this finding. First, the ALJ finds that the preamble merely provides a “set up” for the invention, as Apple suggests. It does not give context, meaning, and structure to the remainder of the claim. *See Pitney Bowes, Inc. v. Hewlett-Packard Co.*, 189 F.3d 1298, 1306 (Fed. Cir. 1997). Apple is correct that it is irrelevant that some of the terms in the preamble provide antecedent basis for other terms in the claim body because they are not terms at issue.

The ALJ finds that the word “dynamically” does not limit claim 1, because “dynamically adding support” merely summarizes the other steps of the claim. Indeed, Motorola’s and Staff’s construction largely repeats element (d) of the claims. Neither Motorola nor Staff is able provide a convincing argument how their construction really differs from element (d), which further undermines a finding that the preamble is limiting. *Marrin v. Griffin*, 599 F.3d 1290, 1294-95 (Fed. Cir. 2010).

As for the prosecution history, the ALJ finds that it is clear enough to overcome the other evidence that the preamble is limiting. The preamble of Claim 1 originally read: “A method for processing system components on a computer with a memory and an operating system resident in the memory.” (JX-4 at 25.) The examiner rejected this claim finding that “processing system components” in the preamble was “vague and indefinite.” (JX-4 at 933.) The examiner went on to say that: “It is not clear what is meant by system components (are these hardware and/or software components?) or how they are processed.” (JX-4 at 933.)

PUBLIC VERSION

The applicant responded to these rejections by the amending claim 1. The applicant responded directly to the examiner's question by replacing "system components" with "hardware and software components." (JX-4 at 963.) The applicant commented that in response to the indefiniteness rejection that "[a]pplicant has made appropriate amendments to particularly point out and distinctly claim the invention in clear and definite terms." (JX-4 at 967.) Indeed, the applicant specifically stated that "the hardware and software components are discussed on page 9 with reference to Figure 2. The hardware components, as shown in Figure 4, could be a printer, machine, or a place. The software components could be a device driver, shared library as shown in Figure 3, or a tool or stationary as shown in Figure 5." (JX-4 at 967.) However, this was still insufficient to obtain allowance of the claims.

The examiner again rejected the claims as being indefinite for "failing to point out and distinctly claim the subject matter which applicant regards as the invention." (JX-4 at 972.) Specifically, the examiner noted that in the preamble, "processing hardware and software components is vague and indefinite." (JX-4 at 972 (quotation marks omitted).) The examiner explained that "[i]t is not clear how these components are processed or what is meant by 'processing[]'" and "[i]t is not seen that there is any processing being done." (JX-4 at 972.) The examiner summed up that "[t]his appears to be a method and apparatus for searching for hardware and software components of a computer system." (JX-4 at 972.) The examiner again repeated that "[i]n claims 1 and 22 the preamble indicates processing hardware and software components; however, the body of the claim speaks of hardware or software components. It is not clear if a search criteria can be directed to hardware only or software only, or if there can be a search for a combination of hardware and software components." (JX-4 at 973.)

PUBLIC VERSION

In response to this rejection, the applicant again amended the preamble. The applicant replaced the problematic “processing” limitation with the phrase “dynamically adding support for” and changed the “and” between “hardware and software” to an “or.” Finally, the applicant also reworded and added to the last clause of the preamble. This clause originally read “on a computer with a memory and an operating system resident in the memory....” The amendment reordered it and added a requirement that the components have properties. The clause now read “with one or more properties to an operating system active on a computer with a memory. . . .” (JX-4 at 983.) The applicant explained that “[t]he Examiner’s § 112 objection in paragraph 3 [of the prior office action] is addressed in the claims that have been crafted to present the patentable subject matter in a clear, concise manner and particularly point out and distinctly claim the invention.” (JX-3 at 985.) The applicant went on to state that “[t]he changes were made to expressly claim the steps summarized in the SUMMARY OF THE INVENTION, ‘add system components (documents, tools, fonts, libraries, etc.) to a computer system without running an installation program.’” (JX-4 at 985.) In addition, the application explained that “[t]he ‘properties’ of the components are also emphasized in the independent claims.” (JX-4 at 985.) Finally, the applicant pointed the examiner to where in the specification the “processing” of the invention was described: “An example in accordance with the claimed invention is presented on page 15 at the bottom of the page and the C++ code used to implement a preferred embodiment is presented to *clarify the processing* and assist a developer to make and use the invention.” (JX-4 at 985 (emphasis added).) Of course, “processing” in the claims had been replaced with “dynamically adding support for.” (JX-4 at 984.)

The prosecution history makes this a close case, but the ALJ is not persuaded the language in the preamble was what was added to necessarily obtain allowance. Indeed, the

PUBLIC VERSION

applicant also amended element (d) during this time to add the limitations of “adding support . . . without rebooting the operating system.” As the ALJ discussed above, the ALJ finds that preamble merely recapitulates that limitation. The remainder of the claim sets forth a complete invention. Accordingly, the ALJ finds that the prosecution history is at best ambiguous as to whether the preamble should be limiting. Where the remainder of the claim sets out a complete invention and there is no clear reliance on the preamble during the prosecution history to obtain allowance, the preamble is not limiting. Accordingly, the ALJ finds that Motorola has not overcome the presumption that the preamble is not a limitation. *Catalina Mktg. Int'l v. Coolsavings.com, Inc.*, 289 F.3d 801, 808-09 (Fed. Cir. 2002).

2. component” terms

Term	Apple’s Proposed Constructions	Motorola’s Proposed Constructions	Staff’s Proposed Constructions
“component(s)” Claims 1, 3, 5	item(s) or resource(s)	indefinite Alternate construction should ALJ Essex determine that this term is not indefinite: documents, fonts, tools, shared libraries, or other such resources	Item or resource
“hardware . . . component(s)” Claims 1, 3	hardware item(s), or resource(s) used by hardware	indefinite Alternate construction should ALJ Essex determine that this term is not indefinite: machines, printers, or persons/places	Hardware resources, such as a machine, printer, or persons/places
“software component(s)” Claims 1, 3	software item(s), or resource(s) used by software	indefinite Alternate construction should ALJ Essex determine that this term is not indefinite: device driver shared libraries, tools, or stationeries	Software resources, such as device drivers, shared libraries, and files

PUBLIC VERSION

Term	Apple's Proposed Constructions	Motorola's Proposed Constructions	Staff's Proposed Constructions
"hardware or software components"	Plain and ordinary meaning, or: hardware or software item(s), or resource(s) used by hardware or software	indefinite Alternate construction should ALJ Essex determine that this term is not indefinite: system components, network components, or application components	Hardware or software resources
"system components" Claim 3	Plain and ordinary meaning, or: system items, or resources used by the system	documents, fonts, tools, shared libraries, or other system resources	Plain and ordinary meaning
"application components" Claim 5	Plain and ordinary meaning, or: application items, or resources used by an application	application resources such as tools, stationeries, or preferences	Plain and ordinary meaning

Apple and Staff agree that the term "component(s)" is used broadly in the patent and means "items or resources." In its pre-hearing statement, Motorola argued that the term was indefinite, but if the ALJ believed that it was capable of construction, that it should be construed as "documents, fonts, tools, shared libraries, or other such resources." Motorola presented no arguments regarding its indefiniteness argument for this term or its alternative construction. Accordingly, the ALJ will deem those arguments waived.

The ALJ finds that the term "component" should be construed to mean "an item or a resource." The intrinsic evidence supports this construction. For example, the patent states that "in the framework an item to be added/removed from the system is called a component." (JX-1 at 5:62-64; *see also* JX-1 at 8:67-68 ("Classes which require locating a specified item within a

PUBLIC VERSION

specified scope. . . .”); *id.* at 1:62-66 (“The method and system include capability for . . . querying the system to identify resources that match the specified system search criteria.”). The breadth of the definition does not mean that it is indefinite.

As for the remaining “component” terms, the ALJ finds that they are merely different types of “components” and no separate construction is necessary. The ALJ notes that several of the constructions offered include examples of the resource in question. The ALJ does not find those additional examples to be necessarily helpful to clarifying the meaning of these terms and declines to include them.

3. specifying a target hardware or software component search criteria including one or more properties” (claim 1)

Apple’s Proposed Constructions	Motorola’s Proposed Constructions	Staff’s Proposed Constructions
specifying desired attributes that are potentially shared by one or more hardware or software components	Plain and ordinary meaning	Plain and ordinary meaning

Motorola and Staff argue that this term should be given its plain and ordinary meaning. Apple suggests a construction of “specifying desired attributes that are potentially shared by one or more hardware or software components.” The key dispute between the parties regards the claim term “properties.” In reality, Apple’s proposed construction hides an additional layer of meaning that Apple seeks to apply to the term. In its brief, Apple clarifies that the term “properties” means “desired attributes that are attached to components rather than being intrinsic parts of the components before use in the framework.” (CIB at 165.) This statement, not Apple’s construction, draws out the main distinction that Apple seeks to make between what Apple calls “intrinsic” or “inherent” parts of a component and “non-intrinsic” or “non-inherent” parts. Apple gives examples such as file names and files sizes, which Apple claims are

PUBLIC VERSION

“intrinsic” parts of a component and cannot be a “property.” (CIB at 165-166.)

Apple’s argument begins with the language of the claims by arguing that Motorola’s construction seeks to render “properties” meaningless. (CIB at 163.) Apple notes that the preamble specifies that the components must have one or more properties and that properties are a narrower subset of the search criteria, but Motorola’s construction does not distinguish between components with properties and those without properties. (CIB at 164.) Apple argues that this difference is captured by the claims using different terms for “search criteria” and “properties.” (CIB at 164.)

Motorola and Staff respond to this argument by asserting that “[t]he term ‘search criteria’ is much broader than ‘properties’ and a user can specify search criteria that are not properties of the target hardware or software components.” (RRB at 63.) For example, the search criteria can include Boolean operators or location limitations. (RRB at 63-64.)

The ALJ finds that under Motorola and Staff’s construction “properties” is not rendered superfluous. “Search criteria” is certainly broader than “properties” and can include non-property entities such as Boolean operators. Indeed, Motorola’s argument that “search criteria” is broader than “properties” is supported by the specification. (*See* JX-1 at 9:30-40 (“The search scope can be a volume, a machine, or anything depending of the implementation provided by the sub-class.”).) As such, the claim language does not preclude Motorola and Staff’s construction. As for Apple’s construction, there is nothing in the claim language that would support Apple’s construction. The claims do not distinguish between “intrinsic characteristics” and properties, so the claim language is at best neutral to Apple’s construction.

As for the specification, Apple argues that the ’430 Patent “institutes a second layer of searchability for components by ‘attaching’ or ‘associating’ properties with every component in

PUBLIC VERSION

the system, and it is a ‘set’ of properties that makes a component findable.” (CIB at 165.) Apple relies on portions of the specification that state “[a] component can have properties associated with it. Every component has some set of properties which identify it.” (CIB at 165 (quoting JX-1 at 5:66-68).) Pointing to the part of the specification that describes the preferred embodiments shown in Figures 9-11, Apple argues that “[t]he patent further describes requests being made to locate components with ‘desired attributes,’ which are ‘system-defined attributes’ attached to components by the system.” (CIB at 165 (citing JX-1 at 13:2-7, 13:11-15, 13:21-24).) Apple argues that “[t]he method described in the preferred embodiment distinguishes between a FindALL command, that would locate all components that share a set of properties, and a FindOne command that would be run after the broader search, and return only the single ‘named’ component that had been located based on ‘properties.’” (CIB at 165 (citing JX-1 at 9:25-46).) Apple argues that “[e]very description in the patent, and every example, treat properties as ‘desired attributes’ that are ‘attached’ to components, rather than as intrinsic characteristics that are not attached, like names and file sizes.” (CIB at 165.)

However, the ALJ finds that the specification does not support Apple’s construction. As Motorola notes, “the words ‘inherent’ and ‘non-inherent’ (as well as ‘intrinsic’ and ‘non-intrinsic’) do not appear anywhere in the ’430 patent.” The ALJ agrees that specification uses properties broadly. For example, the Abstract describes the invention as “[a] location framework is employed to locate system components whose properties match those specified in a search criteria.” (JX-1 at 1:54-56.) Additionally, the specification defines properties broadly and without limitation when it states that “[e]very component has some set of properties which *identify* it.” (JX-1 at 5:67-68 (emphasis added).) Thus, this quote uses “properties” very broadly.

The ALJ further notes that Apple’s efforts to cobble together the three preferred

PUBLIC VERSION

embodiments in columns 12 and 13 support its construction are not persuasive. Apple claims that this section describes “designed attributes, which are system defined attributes.” (CIB at 165.) However, a review of this section reveals that it describes three separate embodiments – a “smart folder,” a “place,” and a “Parts Bin.” The description of the “smart folder” states that “[t]he smart folder then invokes the locator and requests particular documents containing the desired attributes to be collected in the folder.” (JX-1 at 13:2-4.) And that “[a]dditionally, the smart folder can instruct the locator to notify it when new documents containing the desired attributes are added or removed from the system.” (JX-1 at 13:4-7.) At no time does this embodiment suggest that “desired attributes” or properties are limited only to “non-intrinsic” properties or attributes as Apple suggests.

Indeed, this is in sharp contrast to the other two embodiments – the “place” and the “Parts Bin,” in both of those preferred embodiments, the system attaches “system-defined attributes” to the files or devices to be placed in the place or “Parts Bin.” (JX-1 at 13:8-30.) Thus, Apple is incorrect that all three embodiments discuss “system defined attributes” as being “desired attributes.” Thus, it appears from the specification that the embodiment of Figure 9 is not expressly limited as Apple claims and does not support Apple’s inherent/non-inherent distinction.

As for Apple’s last argument regarding the specification that the specification draws a distinction between searching on “properties” and searching on intrinsic properties such as name in column 9, lines 25-45 of the ’430 Patent, the ALJ finds that the ’430 Patent (and this example) does not appear to contain such a distinction. (RIB at 136.) As such, it does not support the limitation that Apple seeks to read into the claims.

The final piece of intrinsic evidence that Apple seeks to rely on is its assertion that “the Patent Office’s decision to treat the property search of the claims differently from the known

PUBLIC VERSION

searches for intrinsic characteristics, like names and file sizes, in the prior art, is supported by the specification's consistent treatment of 'properties' as desired attributes that are attached to components rather than being intrinsic parts of the components before use in the framework." (CIB at 165.) But, there are no statements or actions in the prosecution history to which Apple can point. Apple is relying on the examiner's failure to reject the claims as evidence that the examiner read the claims as Apple now seeks to do so. This is not a proper basis on which to interpret claims. *See, e.g., Prima Tek II, L.L.C. v. Polypap, S.A.R.L.*, 318 F.3d 1143, 1150 (Fed. Cir. 2003) ("We note that drawing inferences of the meaning of claim terms from an examiner's silence is not a proper basis on which to construe a patent claim."). Accordingly, the ALJ rejects this argument.

Apple also relies on extrinsic evidence, the testimony of the named inventor, to support its construction. (CIB at 164-165 (citing JX-469C at 21:9-21; *see also id.* at 57:6-59:19 ("The find command asks the user to manually specify a pattern that resembles the file name. But file name is an intrinsic characteristic of a file, inseparable from the file. It's not additional property that a system or user define and attach to the file.")) However, the ALJ does not find this testimony persuasive in light of the complete lack of support for Apple's construction in the intrinsic evidence. *See N. Am. Vaccine*, 7 F.3d at 1577 ("[W]here the meaning of a claim term is clear from the specification and prosecution history, the inventor's self-serving post-hoc opinion testimony on the legal question whether it should a different meaning was of little if any significance." (citation and quotation marks omitted)).

Finally, Apple and Motorola both resort to the claim construction canon that claims should interpreted to preserve their validity. Apple argues that Motorola is impermissibly attempting to broaden the claims to invalidate them (CIB at 165) and Motorola argues that

PUBLIC VERSION

Apple’s construction would leave the claims vague and indefinite (RIB at 137-138). Motorola also argues that Apple’s argument should be rejected because the claim term is not ambiguous. (RRB at 65.) The ALJ sees no need to resort to this canon of claim construction. The claim language is broad but clear. Moreover, the specification and prosecution history do not support Apple’s construction. This is not an instance to resort to the canon that claims should be interpreted to preserve their validity. *See AK Steel Corp. v. Sollac & Ugine*, 344 F.3d 1234, 1243 (Fed. Cir. 2003) (“That axiom [(construing claims to preserve validity)] is a qualified one, dependent upon the likelihood that a validity-preserving interpretation would be a permissible one.”); *Generation II Orthotics Inc. v. Med. Tech. Inc.*, 263 F.3d 1356, 1365 (Fed. Cir. 2001) (“[C]laims can only be construed to preserve their validity where the proposed claim construction is ‘practicable,’ is based on sound claim construction principles, and does not revise or ignore the explicit language of the claims.”).

Accordingly, the ALJ rejects Apple’s proposed construction and adopts Motorola’s and Staff’s proposed construction that this term should be accorded its plain and ordinary meaning.

4. “querying the operating system” (claim 1)

Apple’s Proposed Constructions	Motorola’s Proposed Constructions	Staff’s Proposed Constructions
attempting to locate components via an operating system protocol or framework	making a system call	Plain and ordinary meaning

The parties do not appear to genuinely dispute this limitation. Motorola offers no argument in its brief and Apple concedes “there should be no real dispute over this claim limitation.” (CIB at 166.) Staff argues that this term should be given its plain and ordinary meaning in this art. (SIB at 107.) Staff argues that the ’430 Patent does not give a special

PUBLIC VERSION

definition to this term, nor does it disclaim anything that would otherwise be considered “querying the operating system.” (SIB at 107.) Staff argues that Motorola’s construction is one type of query, but the literal claim language is not limited to making a system call. Staff also contends that the language Apple proposes reads limitations into the claim. (SIB at 107.) Apple argues that, at times, Motorola has attempted to construe its construction to require querying the “kernel” of the operating system. (CIB at 166.) But the parties now seem to agree that the term is not so limited. (Tr. 1163:2-6; 1164:23-1165:5). As for the rest of the definition, Apple offers no argument or evidence at all in its brief for the additional “framework” limitation that it includes in its definition. (See CIB at 166-167.) Thus, the ALJ agrees with Staff. Both Apple’s and Motorola’s constructions seek to improperly limit the claims without any justification and are rejected. Accordingly, the ALJ accords this term its plain and ordinary meaning.

5. “returning hardware or software components meeting the target hardware or software component search criteria” (Claim 1)

Claim Term	Apple’s Proposed Construction	Motorola’s Proposed Construction	Staff’s Proposed Construction
“meet the target hardware or software component search criteria”	match the desired attributes in the search	Plain and ordinary meaning	Plain and ordinary meaning

The parties’ real dispute (at this point) regarding the construction of “returning hardware or software components meeting the target hardware or software component search criteria” appears to center around what is being returned. Both Motorola and the Staff believe that this term should therefore be given its plain and ordinary meaning, which they assert requires “hardware or software components” to be returned. (RIB at 138.) Additionally, it is Motorola’s position that when the “returning” limitation also requires that the hardware or software

PUBLIC VERSION

components are returned to the initiating class or entity. (RIB at 138.) Apple proposes the construction “providing information identifying the hardware or software components.” Apple argues that Motorola’s construction, which requires additional limitations, is not the plain and ordinary meaning. (CRB at 62.)

Motorola argues that throughout the specification, the terms “return” and “returning” are used in conjunction with returning components, not with returning information identifying components. (RIB at 138-139 (citing JX-1 at 1:66-67; JX-1 at 6:31-36).) Motorola argues that in Figures 6, 7 and 8, “entities” are returned to the initiating class, not information identifying entities. (RIB at 139 (citing JX-1 at 8-10).) Specifically, Motorola notes that the portion of the specification describing Figure 6 reads, “[n]ext, at function block 640, the search is performed to locate appropriate system entities, which are returned via function block 650 to the initiating class, and processing is terminated at terminal 600.” (JX-1 at 8:13-16.) Motorola notes that the specification provides similar descriptions for Figures 7 and 8. (JX-1 at 8:25-29, 8:38-42.)

Apple argues that Motorola is simply incorrect that the “ordinary meaning” supports returning entire components during a search. The result of a search in the computer arts, Apple contends, is more often information (for example, a set of links, pointers, or other references) that allows a user to obtain the actual documents or other desired components after the search. (CX-568C at Q/A 45.)

Beginning with the language of the claims, the claims require that “hardware or software components” be returned. The claims cannot be clearer as to what is returned – it does not say “information about” hardware or software components. For the ALJ to adopt Apple’s construction, the ALJ would have to rewrite the claim. The ALJ further finds that there is no support in the claim language for Motorola’s second limitation that the “hardware or software

PUBLIC VERSION

components” be returned to the initiating class or entity. The claim language is entirely silent as to where the component is returned to.

Apple seeks support from claim 10, which depends on claim 1. Claim 10 requires the additional step of “creating a list of component pointers which provide direct access to the components.” (JX-1 at 14:19-20.) Apple argues that “[t]hat type of list is consistent with how ordinary searches are done[, and] Motorola’s overly narrow reading of the patent would exclude the types of pointers specifically claimed in the dependent claims.” However, the ALJ finds that claim 10 does little to clarify the meaning of the “returning” limitation because Claim 10 does not limit the “returning” element directly, so it does not provide direct differentiation. Moreover, the ALJ finds that there is nothing in Motorola and Staff’s construction that is inconsistent with claim 10. Their construction does not, as Apple alleges, preclude the creation of a list of pointers. The returning limitation deals only with what is returned and does not say where it is returned or what else can be done with what is returned. Claim 10 provides the additional step of creating a list of pointers to directly access the hardware or software component. The ALJ finds that this is perfectly consistent with Motorola’s and Staff’s construction because even after the component is returned, there could still be an additional unrelated step of creating a list of pointers.

The specification provides no help to Apple’s construction. As Motorola demonstrated, the specification repeatedly provides that it is the hardware or software components that are returned. (JX-1 at Figures 6-7; 8:13-16; 8:25-29, 8:38-42.) Apple points to no specific support in the specification for its construction. As for Motorola’s second limitation (that the returning must be to the initiating requester), while there is some support in the specification for that limitation, Motorola points to nothing the specification that would actually require reading that limitation into the claim.

PUBLIC VERSION

Finally, Apple argues, based on Dr. Balakrishnan’s testimony, that “[t]he result of a search, in the computer arts, is more often information (for example, a set of links, pointers, or other references) that allows a user to obtain the actual documents or other desired components after the search.” Apple then goes on to provide an example:

[W]hen a user searches on Google.com for a target web page, a Google web search returns a series of links to web sites or other information; it does not instantiate every web page that potentially matches the search. The user must click through the link to get to the actual target web page. What is “returned” are links, pointers, or other information. The patent discusses returning components in these terms. For example, when the user seeks a hardware component, the system does not somehow return the physical hardware as a result of the search—even in Motorola’s example, what is returned is an “object,” a piece of software that somehow identifies the physical hardware.

This extrinsic evidence, which untethered to the intrinsic evidence or any specific contemporaneous source, is not very persuasive.⁷ This is especially true when the extrinsic evidence is used to support a construction that is inconsistent with claim language.

6. “adding support for the hardware and software components to the operating system” (Claim 1)

Claim Term	Apple’s Proposed Construction	Motorola’s Proposed Construction	Staff’s Proposed Construction
“adding support for the hardware and software components to the operating system”	facilitating access to the hardware or software components	Indefinite	Plain and ordinary meaning

The parties dispute the term “adding support for the hardware and software components to the operating system.” Apple contends that the term should be construed as “facilitating

⁷ The ALJ notes that Apple’s example is particularly inapt because Google did not even exist until several years after the patent was filed. (See <http://www.google.com/about/corporate/company/history.html> (the predecessor to Google did not begin until 1996 and “Google” was not launched until 1997) (last visited January 12, 2012).)

PUBLIC VERSION

access to the hardware or software components.” Motorola contends that the term is indefinite. Staff argues that the term should be given its plain and ordinary meaning.

Claims must “. . . particularly point[] out and distinctly claim[] the subject matter which the applicant regards as his invention.” 35 U.S.C. § 112, ¶ 2; *Miles Laboratories, Inc. v. Shandon Inc.*, 997 F.2d 870, 874-75 (Fed. Cir. 1994). The purpose of this definiteness requirement is to ensure that the claims delineate the scope of the invention using language that adequately notifies the public of the patentee’s right to exclude. *Young v. Lumenis, Inc.*, 492 F.3d 1336, 1346 (Fed. Cir. 2007). If a claim read in light of the specification reasonably apprises one of ordinary skill in the art of its meaning, that claim satisfies § 112, ¶2. *Id.* In contrast, if a claim limitation is “insolubly ambiguous” or “not amenable to construction,” then the claim containing that limitation is invalid for indefiniteness. *See, e.g., Datamize, LLC v. Plumtree Software, Inc.*, 417 F.3d 1342, 1347-1356 (Fed. Cir. 2005) (affirming summary judgment of invalidity due to indefiniteness); *Honeywell Int’l, Inc. v. United States Int’l Trade Comm.*, 341 F.3d 1332, 1338-1339 (Fed. Cir. 2003).

The ALJ finds that the term should be given its plain and ordinary meaning. The ALJ further finds that Apple’s proposed construction fails. The claims as originally filed included a limitation of “to enable access to the one or more system components.” The examiner objected to this limitation saying “it is not clear what ‘enable access’ to a system component means.” (JX-4 at 935.) In response, the applicant deleted the entire phrase “enable access to the one or more system components.” (JX-4 at 963.) The ALJ can discern no difference (and Apple provides none) between Apple’s proposed construction and the claim language that the examiner rejected as indefinite. (Tr. 464:24-465:6, 475:7-12; *see also* RX-1796.) The ALJ finds that adopting Apple’s construction would in effect re-write the claim to include the language that the

PUBLIC VERSION

examiner objected to and that was deleted from the claim. Moreover, Apple's construction would eliminate the requirement that support be added "to the operating system." This is contrary to the plain language of the claim, which further suggests that Apple's construction is incorrect.

As for Motorola's contention that the claim is indefinite, there is certainly some merit to that argument. Apple's own expert claimed that none of the embodiments in the patent disclosed adding support as described in the claims. (Tr. 1664:7-1666:2.) Indeed, Dr. Balakrishnan's testimony at the hearing was not confidence inspiring as to the definiteness of the claims:

Q. And how is someone acting in good faith who doesn't want to infringe this patent going to be able to determine under your construction how many degrees is safe, if it is a question of degree? They are not going to be able to, are they?

A. If you are saying is there something drawn in the sand, a line drawn in the sand per se, yes, *it is a little bit flexible, let's put it that way.*

Q. *It is flexible. Is that what you said?*

A. *Yes.*

...

Q. And it is your contention to His Honor that this phrase "facilitating access," that a person of ordinary skill would know when they were facilitating access and when they weren't?

A. In terms of adding support, which is element D of the claim --

Q. In terms of your construction, facilitating access.

A. For that element D, yes.

Q. Okay. *And where would they draw the bright line boundary there?*

A. Well, *I don't think there is a hard boundary per se, no.*

(Tr. 467:13-25; 475:13-25 (emphasis added).)

However, the ALJ finds that Dr. Balakrishnan's earlier testimony regarding "support" to be informative on the issue of indefiniteness:

PUBLIC VERSION

QUESTION 100: How does the patent specification discuss “adding support” for components?

ANSWER: There are at least three distinct situations in the patent where support is added for components. The first is for new components that are added to the system, such as new hardware devices that would ordinarily require new driver code. **CDX-001.034** shows column 5, lines 7 to 14, where the patent discusses adding support for new multimedia devices by using the properties of the device to locate and load existing driver code. The second is the technique used for applications, whether or not they are brand new to the system, where existing “puzzle pieces” can be fit together on the fly. This is shown at **CDX-001.035**, which shows column 5, lines 29 to 65. The third is for components that are on the system but must be collected and tracked, for example in smart folders. Beyond the typical smart foldering functionality, these components are supported

throughout the system, for example by permitting the system to provide notifications that components have been added, removed, or changed. That is shown in **CDX-001.036** at column 1, lines 44-47.

(CX-201C at Q/A 100; *see also* Tr. 1726:25-1727:21.) The ALJ finds that this testimony shows that there are some guideposts for the person of ordinary skill in the art as to the scope of the claims.

Taking all this evidence together, the ALJ finds that although the disclosure is very sparse, it is sufficient to give the claim term definition. Accordingly, in light of all of the evidence, the ALJ finds that the claim term is not indefinite.

As for the proper construction, the ALJ finds that the claim language provides the best guidance. It is clear that “support” is used in the patent very broadly as Apple suggests. However, the ALJ finds that “adding support for hardware or software components to the operating system” is slightly narrower because it requires “support” be added to the operating system and is contained in the plain language of the claims. Accordingly, the ALJ finds that

PUBLIC VERSION

“adding support for hardware or software components to the operating system” has its plain and ordinary meaning.

V. INFRINGEMENT DETERMINATION

A. Applicable Law

In a Section 337 investigation, the complainant bears the burden of proving infringement of the asserted patent claims by a preponderance of the evidence. *Certain Flooring Products*, Inv. No. 337-TA-443, Commission Notice of Final Determination of No Violation of Section 337, 2002 WL 448690 at 59, (March 22, 2002); *Enercon GmbH v. Int’l Trade Comm’n*, 151 F.3d 1376 (Fed. Cir. 1998).

Each patent claim element or limitation is considered material and essential. *London v. Carson Pirie Scott & Co.*, 946 F.2d 1534, 1538 (Fed. Cir. 1991). Literal infringement of a claim occurs when every limitation recited in the claim appears in the accused device, *i.e.*, when the properly construed claim reads on the accused device exactly. *Amhil Enters., Ltd. v. Wawa, Inc.*, 81 F.3d 1554, 1562 (Fed. Cir. 1996); *Southwall Tech. v. Cardinal IG Co.*, 54 F.3d 1570, 1575 (Fed Cir. 1995).

If the accused product does not literally infringe the patent claim, infringement might be found under the doctrine of equivalents. The Supreme Court has described the essential inquiry of the doctrine of equivalents analysis in terms of whether the accused product or process contains elements identical or equivalent to each claimed element of the patented invention. *Warner-Jenkinson Co., Inc. v. Hilton Davis Chemical Co.*, 520 U.S. 17, 40 (1997).

Under the doctrine of equivalents, infringement may be found if the accused product or process performs substantially the same function in substantially the same way to obtain substantially the same result. *Valmont Indus., Inc. v. Reinke Mfg. Co.*, 983 F.2d 1039, 1043 (Fed.

PUBLIC VERSION

Cir. 1993). The doctrine of equivalents does not allow claim limitations to be ignored. Evidence must be presented on a limitation-by-limitation basis, and not for the invention as a whole. *Warner-Jenkinson*, 520 U.S. at 29; *Hughes Aircraft Co. v. U.S.*, 86 F.3d 1566 (Fed. Cir. 1996). Thus, if an element is missing or not satisfied, infringement cannot be found under the doctrine of equivalents as a matter of law. *See, e.g., Wright Medical*, 122 F.3d 1440, 1444 (Fed. Cir. 1997); *Dolly, Inc. v. Spalding & Evenflo Cos., Inc.*, 16 F.3d 394, 398 (Fed. Cir. 1994); *London v. Carson Pirie Scott & Co.*, 946 F.2d 1534, 1538-39 (Fed. Cir. 1991); *Becton Dickinson and Co. v. C.R. Bard, Inc.*, 922 F.2d 792, 798 (Fed. Cir. 1990).

The concept of equivalency cannot embrace a structure that is specifically excluded from the scope of the claims. *Athletic Alternatives v. Prince Mfg., Inc.*, 73 F.3d 1573, 1581 (Fed. Cir. 1996). In applying the doctrine of equivalents, the Commission must be informed by the fundamental principle that a patent's claims define the limits of its protection. *See Charles Greiner & Co. v. Mari-Med. Mfg., Inc.*, 92 F.2d 1031, 1036 (Fed. Cir. 1992). As the Supreme Court has affirmed:

Each element contained in a patent claim is deemed material to defining the scope of the patented invention, and thus the doctrine of equivalents must be applied to individual elements of the claim, not to the invention as a whole. It is important to ensure that the application of the doctrine, even as to an individual element, is not allowed such broad play as to effectively eliminate that element in its entirety.

Warner-Jenkinson, 520 U.S. at 29.

Prosecution history estoppel may bar the patentee from asserting equivalents if the scope of the claims has been narrowed by amendment during prosecution. A narrowing amendment may occur when either a preexisting claim limitation is narrowed by amendment, or a new claim limitation is added by amendment. These decisions make no distinction between the narrowing of a preexisting limitation and the addition of a new limitation. Either amendment will give rise

PUBLIC VERSION

to a presumptive estoppel if made for a reason related to patentability. *Honeywell Int'l Inc. v. Hamilton Sundstrand Corp.*, 370 F.3d 1131, 1139-41 (Fed. Cir. 2004), *cert. denied*, 545 U.S. 1127 (2005)(citing *Warner-Jenkinson*, 520 U.S. at 22, 33-34; and *Festo Corp. v. Shoketsu Kinzoku Kogyo Kabushiki Co.*, 535 U.S. 722, 733-34, 741 (2002)). The presumption of estoppel may be rebutted if the patentee can demonstrate that: (1) the alleged equivalent would have been unforeseeable at the time the narrowing amendment was made; (2) the rationale underlying the narrowing amendment bore no more than a tangential relation to the equivalent at issue; or (3) there was some other reason suggesting that the patentee could not reasonably have been expected to have described the alleged equivalent. *Honeywell*, 370 F.3d at 1140 (citing, *inter alia*, *Festo Corp. v. Shoketsu Kinzoku Kogyo Kabushiki Co.*, 344 F.3d 1359 (Fed. Cir. 2003)(*en banc*)). “Generalized testimony as to the overall similarity between the claims and the accused infringer’s product or process will not suffice [to prove infringement under the doctrine of equivalents].” *Tex. Instruments, Inc. v. Cypress Semiconductor Corp.*, 90 F.3d 1558, 1567 (Fed. Cir. 1996).

Section 271(b) of the Patent Act prohibits inducement: “[w]hoever actively induces infringement of a patent shall be liable as an infringer.” 35 U.S.C. § 271(b) (2008). As the Federal Circuit stated:

To establish liability under section 271(b), a patent holder must prove that once the defendants knew of the patent, they “actively and knowingly aid[ed] and abett[ed] another’s direct infringement.” However, “knowledge of the acts alleged to constitute infringement” is not enough. The “mere knowledge of possible infringement by others does not amount to inducement; specific intent and action to induce infringement must be proven.”

DSU Med. Corp. v. JMS Co., 471 F.3d 1293, 1305 (Fed. Cir. 2006) (*en banc*) (citations omitted);
See also Cross Medical Products, Inc. v. Medtronic Sofamor Danek, Inc., 424 F.3d 1293, 1312

PUBLIC VERSION

(Fed. Cir. 2005) (“In order to succeed on a claim inducement, the patentee must show, first that there has been direct infringement, and second, that the alleged infringer knowingly induced infringement and possessed specific intent to encourage another’s infringement.”). Mere knowledge of possible infringement by others does not amount to inducement. Specific intent and action to induce infringement must be proven. *Warner-Lambert Co. v. Apotex Corp.*, 316 F.3d 1348, 1363 (Fed. Cir. 2003). In *DSU*, the Federal Circuit clarified the intent requirement necessary to prove inducement. As the court recently explained:

In *DSU Med. Corp. v. JMS Co.*, this court clarified en banc that the specific intent necessary to induce infringement “requires more than just intent to cause the acts that produce direct infringement. Beyond that threshold knowledge, the inducer must have an affirmative intent to cause direct infringement.”

Kyocera Wireless Corp. v. Int’l Trade Comm’n, 545 F.3d 1340, 1354, (Fed. Cir. 2008) (citation omitted). “Proof of inducing infringement requires the establishment of a high level of specific intent.” *Lucent Techs. Inc. v. Gateway, Inc.*, 2007 WL 925510, at *2-3 (S.D. Cal. 2007)

Under 35 U.S.C. § 271(c), “[w]hoever offers to sell or sells within the United States or imports into the United States a component of a patented machine, manufacture, combination, or composition, or a material or apparatus for use in practicing a patented process, constituting a material part of the invention, knowing the same to be specifically made to or specially adapted for use in the infringement of the patent, and not a staple article or commodity suitable for substantial non-infringing use, shall be liable as a contributory infringer.”

A seller of a component of an infringing product can also be held liable for contributory infringement if: (1) there is an act of direct infringement by another person; (2) the accused contributory infringer knows its component is included in a combination that is both patented and infringing; and (3) there are no substantial non-infringing uses for the accused component,

PUBLIC VERSION

i.e., the component is not a staple article of commerce. *Carborundum Co. v. Molten Equip. Innovations, Inc.*, 72 F.3d 872, 876 (Fed. Cir. 1995).

To prove direct infringement, Apple must prove by a preponderance of the evidence that the accused products either literally infringe or infringe under the doctrine of equivalents the method of asserted claims of the '828, the '607 and the '430 Patents. *Advanced Cardiovascular Sys., Inc. v. Scimed Life Sys., Inc.*, 261 F.3d 1329, 1336 (Fed. Cir. 2001). Notably, method claims are only infringed when the claimed process is performed. *Ormco Corp. v. Align Technology, Inc.*, 463 F.3d 1299, 1311 (Fed. Cir. 2006).

In order to determine whether an accused structure literally meets a 35 U.S.C. §112, ¶ 6 means-plus-function limitation, the accused structure must either be the same as the disclosed structure or be a 35 U.S.C. §112, ¶ 6 “equivalent,” *i.e.*, (1) perform the identical function and (2) be insubstantially different with respect to structure. Two structures may be “equivalent” for purposes of 35 U.S.C. §112, ¶ 6 if they perform the identical function, in substantially the same way, with substantially the same result. *Kemco Sales, Inc. v. Control Papers Co.*, 208 F.3d 1352, 1364 (Fed. Cir. 2000) (internal citations omitted). In other words, once identity of function has been established, the test for infringement is whether the structure of the accused product performs in substantially the same way to achieve substantially the same result as the structure disclosed in the specification. *Minks v. Polaris Industries, Inc.*, 546 F.3d 1364, 1379 (Fed. Cir. 2008

However, if an accused structure is not a 35 U.S.C. §112, ¶ 6 equivalent of the disclosed structure because it does not perform the identical function of that disclosed structure, it may still be an “equivalent” under the doctrine of equivalents. Applying the traditional function-way-result test, the accused structure must perform substantially the same function, in substantially

PUBLIC VERSION

the same way, to achieve substantially the same result, as the disclosed structure. A key feature that distinguishes “equivalents” under 35 U.S.C. §112, ¶ 6 and “equivalents” under the doctrine of equivalents is that equivalents under 35 U.S.C. §112, ¶ 6 must perform the identical function of the disclosed structure, while equivalents under the doctrine of equivalents need only perform a substantially similar function. *Kemco Sales*, 208 F.3d at 1364 (internal citations omitted). Furthermore, a structure failing to meet either the “way” and/or “result” prong under the 35 U.S.C. §112, ¶ 6 test must fail the doctrine of equivalents test for the same reason(s). *Id.*

B. The '828 Patent

Apple asserts that the Motorola Atrix, Backflip, Bravo, Charm, Citrus, Cliq 2, Cliq XT/Quench, Defy, Droid, Droid 2, Droid 2 Global, Droid Bionic, Droid Pro, Droid X, Droid X2, Droid 3, Flipout, Flipside, i1, Titanium, Xoom, and XPRT (the “Accused '828 Products”) infringe claims 1, 2, 10, 11, 24, 25, 26, and 29 of the '828 Patent. (CIB at 51-52.) Each of these products contains an integrated circuit supplied by Atmel Corporation for processing touch data. (CIB at 52; RIB at 90.) The parties largely agree about how the products work. (RIB at 90; CIB at 52-53.) The primary dispute between the parties regarding the '828 Patent centers on whether the Accused '828 Products meet the “mathematically fit(ting) an ellipse” limitation found in all of the asserted claims. (RIB at 90-118; SIB at 31-41; CIB at 52-72.)

1. Mathematically Fit(ting) An Ellipse

Apple argues that all of the Accused '828 Products meet this limitation. (CIB at 76.) There is no dispute that the Atmel touch sensor ICs read electrical signals from the touchscreen and run firmware for processing the touch data. (CIB at 52; RIB at 90; RX-1895C at Q/A 72-74; CX-201C at Q/A 510-511.) As Motorola explained (and Apple agrees), the Atmel chip XXXXXXXXXX

PUBLIC VERSION

[REDACTED]

[REDACTED]. (RIB

at 90 (citing RX-1895C at Q/A 75-76); CIB at 53 (citing CX-201C at Q/A 518-519; JX-661C at

8 [REDACTED]

[REDACTED]

[REDACTED]

[REDACTED] The Accused '828 Products [REDACTED] and, under the ALJ's construction, the claims are not limited to self-capacitance.

Motorola explains that [REDACTED]

[REDACTED], as shown in the example below:

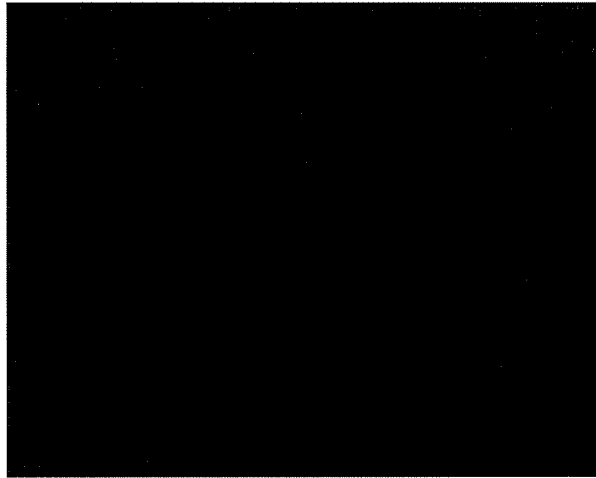

(RIB at 90 & RX-1895C at Q/A 76 at Fig. WB9). In the example shown above, the numbers represent values proportional to [REDACTED]

[REDACTED] (RIB at 90.)

The parties agree that after assembling an array of data such as that shown in the example above, the Atmel chip filters out noise and looks for one or more touches using what are called

“search algorithms [REDACTED]. (RIB

PUBLIC VERSION

at 90 (citing RX-1895C at Q/A 76); CIB at 54-55 (citing JX-661C at 1; CX-201C at Q/A 518-519; RX-1895C at Q/A 76.) The result of this process is the identification of a touch or touches, such as in the examples shown below:



(RDX-11.32C (orange and green touches); RDX-11.33C (purple and blue touches).)

The parties agree that once the Atmel chip has identified a touch or touches, the Atmel chip performs further processing to generate what is called [REDACTED] (RIB at 91 (citing RX-1895C at Q/A 75); CIB at 56 (citing CX-201C at Q/A 527-528; RX-1895C at Q/A 77-92; RX-1879C at Q/A 12-19; JX-662C at 39-42) (Motorola Xoom); CIB at 63 (citing RDX-12.3; RDX-12.4) (Motorola Xoom test build); CIB at 64 (citing RDX-12.5; RDX-12.6) (Motorola handsets); CIB at 65 (citing RDX-12.7; RDX-12.8) (Motorola Droid X test build); CIB at 68-69.) This [REDACTED]—which in the Accused '828 Products comprises the values [REDACTED] [REDACTED] and (for non-test build Motorola Xoom) [REDACTED]—provides specific information about each touch to [REDACTED]. (RIB at 91; CIB at 56, 64, 65, 68-69.) In the Accused '828 Products, [REDACTED] [REDACTED] so that the device can perform functions in response to input from the touchscreen. (RIB at 91 (citing RX-1895C at Q/A 93-115); CIB at 56-57).

PUBLIC VERSION

The parties also do not dispute what the [REDACTED] values represent. (RIB at 93-96; CIB at 56.) The first two values, [REDACTED], represent [REDACTED] respectively. (RIB at 93 (citing RX-1895C, Wolfe Q/A 80; Tr. 598:23-599:12); CIB at 56 [REDACTED] (citing JX-662C at 39-42 & CX-201C at Q/A 528).) The third value, [REDACTED] (RIB at 94 (citing RX-1895C at Q/A 77; Tr. 599:13-600:7); CIB at 56 (“ . . . [REDACTED] . . .”).) The fourth value, [REDACTED] [REDACTED] (RIB at 95 (citing RDX-1895C at Q/A 78-79; Tr. 602:13-24); CIB at 56 (. . . [REDACTED] . . .”).)

As Motorola explained, in one Accused ’828 Product—the non-test build of the Motorola Xoom—[REDACTED]. (RIB at 96; CIB at 56 (“ . . . [REDACTED]

[REDACTED] Motorola explains (and Apple does not dispute) that [REDACTED] [REDACTED] [REDACTED] (RIB at 96-97 (citing RX-1895C at Q/A 91; Tr. 621:21-623:10); CIB at 56).

Motorola illustrates this in the figure below.

PUBLIC VERSION



(RX-1895C, Wolfe Q/A 76 Fig. WB10.) To calculate [REDACTED]

[REDACTED]. (RIB

at 97.) In this example, this [REDACTED]

[REDACTED]

[REDACTED]

[REDACTED]

[REDACTED]

[REDACTED] (See RX-1885C, Wolfe Q/A 76.) In the figure above, the [REDACTED]

[REDACTED]. (Id.)

[REDACTED]

[REDACTED] (See RDX-1895C, Wolfe Q/A 78-79;

Balakrishnan, Tr. 602:13-24.) The orange and green touches [REDACTED]

[REDACTED] (RIB at 95.) As Motorola explained (and Apple does not dispute), the

orange touch has [REDACTED]. (RIB at

95.) The Atmel chip then [REDACTED]

PUBLIC VERSION

█ respectively. █ for the orange touch is therefore █.
(RIB at 95.) The █ of the green touch is therefore █—the
█. (RIB at 95.)

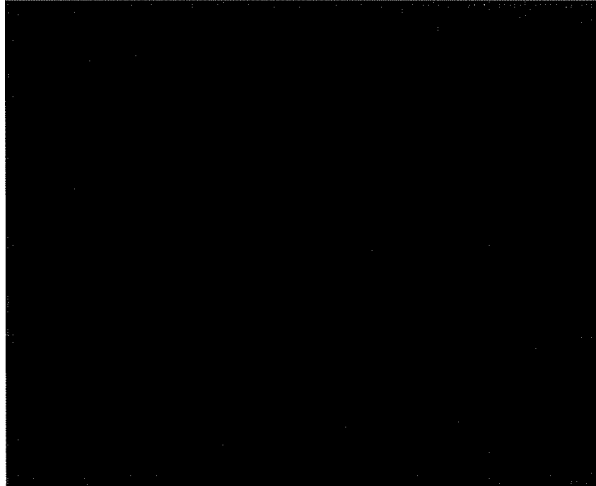

(RDX-11.32C.)

a) Motorola Xoom (Non-Test Build)

As noted above, Apple agrees with this basic explanation of what the Atmel chip does, but goes on to argue that, for example, in the Motorola Xoom (non-test build), the Atmel chip computes a set of numerical parameters that are transmitted to the Android Honeycomb operating system,⁸ and “these parameters are used to define values for several Android commands known as ‘methods’ which in turn are used to mathematically fit an ellipse to approximate touches to the touch screen.” (CIB at 56.) Apple argues that “[t]he parameters are then used to define a set of values that are provided to applications and users through methods in the Android MotionEvent class, such as getX(), getY(), getTouchMajor(), getTouchMinor(), and getOrientation().” (CIB at 56 (citing Tr. 650:23-655:11; RDX-12.1-.2). Apple argues that in the Google documentation, “these are further described: getX() returns the X coordinate of a touch

⁸ “Honeycomb” is a particular version of the Android operating system. (CIB at 56.)

PUBLIC VERSION

event, getY() returns the Y coordinate, getTouchMajor() returns the length of the major axis of an ellipse that describes a contact, getTouchMinor() returns the length of the major axis of an ellipse that describes a contact, and getOrientation() returns the orientation of a contact.” (CIB at 56-57 (citing CX-181.010; Tr. 1038:11-1039:25).)

Apple argues that under its construction for “mathematically fit(ting) an ellipse” that “[t]here is no dispute that the numerical parameters in the Motorola Xoom are computed using mathematical processes.” (CIB at 57.) Apple argues that “[t]he parties dispute whether the [Accused ’828 Products] meet the second part of Apple’s proposed construction, which requires that the computed parameters ‘mathematically define an ellipse which approximates the shape of a pixel group.’” (CIB at 57.) Apple argues that (for the Motorola Xoom (non-test build) “[t]he evidence presented at the hearing shows that the computed parameters mathematically define an ellipse in the Motorola Xoom because they are used to define values for the five classical parameters of an ellipse that are described in the ’828 Patent: getX(), getY(), getTouchMajor(), getTouchMinor(), and getOrientation() provide values for X position, Y position, major axis, minor axis, and orientation.” (CIB at 57 (citing CX-181 at 10; JX-3 at 25:54-27:8).)

Apple argues that [REDACTED] for the Accused ’828 Products show that [REDACTED] in the Xoom do define an ellipse, and the final result of the processing in the Xoom is a set of values that defines the five classical parameters of an ellipse that are described in the ’828 Patent: X position, Y position, major axis, minor axis, and orientation.” (CIB at 59.) Apple argues that [REDACTED] [REDACTED] show that the Xoom was designed to fit an ellipse, and by computing these ellipse parameters, it does mathematically fit an ellipse under Apple’s construction.” (CIB at 59.)

PUBLIC VERSION

Apple heavily relies on the flowcharts (shown in RDX-12C) illustrating what happens in the Android code. (CIB at 58 (citing RDX-12C).) Apple argues that “[t]he top of RDX-12.1 shows five variables . . . that correspond to the parameters computed in the [REDACTED]

used in the Motorola Xoom: [REDACTED]

[REDACTED] (CIB at 58.) Apple argues that these parameters are transmitted to the [REDACTED] in the Motorola Xoom as multitouch variables with input codes:

[REDACTED]

[REDACTED]. (CIB at 58 (citing Tr. 652:9-24).)

Apple argues that the values of the five variables (getX(), getY(), getTouchMajor(), getTouchMinor(), and getOrientation()) are used to derive several parameters that are provided to applications in the Motorola Xoom. (CIB at RDX-12.2C; Tr. 653:22-654:18.) Apple argues that there are nine methods in the MotionEvent.java box at the bottom of RDX-12.2, and that “[f]ive of these methods return values that mathematically define the five classical parameters of an ellipse: getX(), getY(), getTouchMajor(), getTouchMinor(), and getOrientation().” (CIB at 58 (citing Tr. 654:11-655:9).)

Apple explains that [REDACTED] are read into the Motorola Xoom touch driver through [REDACTED] (CIB at 60 (citing RDX-12.1)), and that “these are associated with comments that describe [REDACTED]

[REDACTED]

[REDACTED] (CIB at 60 (citing JX-462 at 1.) Apple argues that Dr. Balakrishnan explained that [REDACTED]

[REDACTED] are used as part of a process that mathematically defines an ellipse and therefore infringes this element

PUBLIC VERSION

under Apple's construction. (CIB at 60 (citing Tr. 652:5-24).) Apple argues that "[a]lthough there is processing that occurs between each of these steps, the same information is passed from [REDACTED] to the [REDACTED] through variables in the Google source code, and output by the MotionEvent methods." (CRB at 16.) Apple argues that "[t]here is nothing in the '828 Patent that requires distinguishing between an ellipse and other shapes." (CRB at 17.) Apple argues that "[t]he parameters computed in the '828 Patent are X centroid position, Y centroid position, major axis, minor axis, and orientation[.]" and "[t]hese same parameters are computed in the Motorola Xoom." (CRB at 17.) Apple argues that "[t]here is no additional requirement for a method that distinguishes between ellipses and other shapes; it is clear from the disclosure in the '828 Patent that the computed parameters mathematically define an ellipse, and it is similarly clear from the source code and documentation in the Motorola Xoom that the [REDACTED] mathematically define an ellipse." (CRB at 17.)

Apple argues that the intent of Motorola and Atmel's engineers not to fit an ellipse to the pixel group data is irrelevant. (CRB at 18 (citing *Fla. Prepaid Postsecondary Educ. Expense Bd. v. Coll. Sav. Bank*, 527 U.S. 627, 645 (1999)).) Apple further argues that their testimony is contradicted by the numerous references to ellipses throughout [REDACTED] [REDACTED] (CRB at 18.) Apple argues that "the use of an ellipse model makes sense because fingers on a touchscreen are generally elliptical in shape." (CRB at 18.) And that "[r]egardless of the stated intent of the designers, the Xoom computes numerical parameters that mathematically define an ellipse and therefore meets this limitation." (CRB at 18.)

Apple argues that "[a]n example of how the Motorola Xoom [(non-test build)] mathematically defines an ellipse is the process of deriving an eccentricity value from [REDACTED] [REDACTED] (CIB at 61.) Apple

PUBLIC VERSION

argues that in the [REDACTED] document there is a section corresponding to the [REDACTED] that states:

[REDACTED]

(JX-539C at 17-18.)

Apple notes that [REDACTED] [REDACTED] which is consistent with the usage of eccentricity in the context of ellipses and the '828 Patent and in the Google source code. (CIB at 61 (citing JX-539C at 18).) Apple notes that eccentricity is described explicitly in the '828 Patent as an ellipse parameter that is the ratio of major axis length to minor axis length. (CIB at 61.) Apple argues that this is depicted on the right side of RDX-12.2, where [REDACTED] [REDACTED] returned by `getTouchMinor()`. (CIB at 61.) Apple argues that the Motorola Xoom thus uses eccentricity consistent with the '828 Patent as a scaling factor between major and minor axis lengths. Apple also argues that other ellipse parameters are derived in similar ways using formulas described in Google documentation and depicted on RDX-12.2.

Apple argues that the Motorola Xoom defines values that can be provided to applications through the `MotionEvent` class depicted on the bottom of RDX-12.2, which include `getX()`, `getY()`, `getTouchMajor()`, `getTouchMinor()`, and `getOrientation()`. (CIB at 62.) Apple argues that “[t]hese five methods correspond directly to the five classical parameters of an ellipse described in the '828 Patent. . . .” (CIB at 62.) Apple further argues that “Android documentation explicitly describes the `getTouchMajor()` and `getTouchMinor()` values as ‘the

PUBLIC VERSION

length of the major axis of an ellipse that describes the touch area' and 'the length of the minor axis of an ellipse that describes the touch area,' respectively." (CIB at 62 (citing CX-181 at 11; Tr. 1037:18-1038:1039:2).) Apple argues that a Google witness admitted with these five parameters, he could construct or draw an ellipse. (CIB at 62 (citing Tr. 1025:2-1026:4).) Apple's infringement argument is essentially "[t]he evidence thus shows that the Motorola Xoom computes numerical parameters that mathematically define an ellipse because those parameters are used to define the five classical parameters of an ellipse that are described in the '828 Patent." (CIB at 62.)

In other words, Apple argues that "[t]his requirement that the computed parameters mathematically define an ellipse is not substantively different from the requirement for an 'ellipse model'" that Motorola argues. (CRB at 17.) Apple argues that "[t]he absence of an ellipse model is a key reason why prior art references like Bisset '352 do not anticipate the '828 Patent," and "the presence of an ellipse model is a key reason why the '828 Accused Products infringe the asserted claims of the '828 Patent." (CRB at 17.)

In particular, Apple argues that in the Atmel source code that runs on the Motorola Xoom, "there is an explicit comment referring to [REDACTED] [REDACTED] (CIB at 59 (citing JX-460C at ATMEL-ITC-SC000031).) Apple argues that an Atmel engineer admitted "that this referred to a contact on the touchscreen, and that the general shape of a finger as it touches is most often some form of an ellipse." (CIB at 59 (citing Tr. 1002:16-1003:20).) Apple further argues that this reference is "consistent with Dr. Westerman's explanation for why he used ellipse fitting for the '828 Patent, since fingers touching a surface generally have a shape similar to an ellipse." (CIB at 59.)

In addition to [REDACTED] Apple relies on [REDACTED]

PUBLIC VERSION

[REDACTED]. Apple argues that [REDACTED] that further demonstrates that the parameters computed by the Atmel touch sensor ICs mathematically define an ellipse.” (CIB at 60 (citing CX-73C).) [REDACTED]
[REDACTED]
(CIB at 60.)

Apple argues that its infringement theory is not inconsistent with what its expert said in his direct witness statement. (CRB at 19.) Apple argues that Dr. Balakrishnan stated that “the processing performed in the Atmel sensor ICs includes a step of mathematically fitting an ellipse to at least one of the pixel groups, ” (CX-201C at Q/A 526), and that “these parameters are used in the Motorola Xoom to provide values that mathematically define an ellipse using the same parameters described in the ’828 Patent.” (CRB at 19.)

Motorola, on the other hand, argues that [REDACTED] provides any information regarding the size, shape, or orientation of a touch.” (RIB at 93.) Motorola further argues that [REDACTED] provides no information about the shape or orientation of a touch. (RIB at 94.) Motorola further argues that [REDACTED], does not provide two-dimensional information at *all*. (RIB at 95.) Motorola argues that, as illustrated above, [REDACTED] does not provide information about the shape, size, or orientation of a touch. Motorola further argues none of values [REDACTED] [REDACTED] are calculated by mathematically fitting an ellipse or correspond to an ellipse model. (RIB at 95 (citing RX-1895C at Q/A 91; Tr. 78:4-17; RX-1879C at Q/A 16-22; *id.* at 17 (“The components of [REDACTED] [REDACTED] *id.* at 19 [REDACTED]

PUBLIC VERSION

[REDACTED]

Motorola also argues that there is no dispute that the Atmel chip is [REDACTED]. (RIB at 100 (citing Tr. 580:2-21, 581:16-20).) Motorola argues that because information regarding some aspect of a touch such as height, width, shape, or orientation [REDACTED]. (RIB at 100 (citing Tr. 701:16-702:6; Tr. 1054:5-19).)

Motorola argues that the third value, [REDACTED] (RIB at 94 (citing RX-1895C at Q/A 77; Tr. 599:13-600:7).)

Motorola argues that “[t]he asserted claims of the ‘828 patent require mathematically fitting an ellipse to a *pixel group*.” (RIB at 92 (emphasis in the original).) Motorola argues that consistent with the language of the claims that requires fitting the ellipse to the pixel group and the operation of the Atmel chip, that Dr. Balakrishnan in direct witness statement only identified [REDACTED] in connection with his assertions that the ‘828 Accused Products mathematically fit an ellipse to at least one pixel group:

PUBLIC VERSION

QUESTION 526: Does the method for processing input from the touchscreen of the Accused Products include a step of mathematically fitting an ellipse to at least one of the pixel groups?

ANSWER: Yes, the processing performed in the [REDACTED] includes a step of mathematically fitting an ellipse to at least one of the pixel groups.

QUESTION 527: What evidence did you consider in forming your opinion?

ANSWER: The [REDACTED] describe numerical parameters that are computed for each multitouch object corresponding to a pixel group. As shown on CDX-01.549, these parameters are listed in the message data for [REDACTED] which are parameters that mathematically define an ellipse.

(CX-201C at Q/A 526 & 527.) Motorola argues that Apple’s new infringement theory that now includes the Android operating system, which has no access to the underlying pixel data, is an attempt to confuse the issues. (RIB at 92.)

Motorola argues that the fourth value, [REDACTED] “does not provide two-dimensional information at *all*.” (RIB at 95.) Motorola argues that “Dr. Balakrishnan conceded that there is no literal infringement by *any* of the ‘828 Accused Products of *any* of the asserted claims under Motorola’s and the Staff’s proposed construction for ‘mathematically fitting an ellipse to at least one of the pixel groups.’” (RIB at 95 (citing CX-201C at Q/A 534 (“The Accused Products [REDACTED] so there is no literal infringement under Motorola’s construction.”); *id.* at 560-61 (same for claim 10); *id.* at 577 (same for claim 24)).)

Motorola argues that [REDACTED] (RIB at 98 (citing RX-1895C at Q/A 295; RX-1879C at Q/A 20-22; Tr. 1045:22-1046:10).)

Motorola argues that even where five parameters (including [REDACTED] are computed there is no infringement because the five numerical parameters (size, position, orientation, major and minor axes) “falling into these categories do not, [REDACTED] (RIB at 101.) Motorola argues that even “Apple’s proposed construction still requires

PUBLIC VERSION

[REDACTED] (RIB at 102 (citing Tr. 545:2-18; 556:3-8).) Motorola argues that “Atmel and Google witnesses testified that neither the Atmel firmware nor the Android input protocol [REDACTED] in any of the [Accused ’828 Products], including the non-test build of the Motorola Xoom.” (RIB at 102.) Motorola argues that Apple’s expert never identified [REDACTED] and his testimony focused on ancillary documentation, code comments and other documents that do not deal with how the Accused ’828 Products actually process touch data. (RIB at 103.)

As for the Atmel [REDACTED] Motorola argues that Dr. Balakrishnan admitted on cross-examination, however, that [REDACTED] was “not in the Motorola products,” and agreed that a computer did not [REDACTED] in order for the computer to draw an ellipse. (RIB at 104 (citing Tr. 625:5-626:10).)

Motorola argues that Dr. Balakrishnan never opined in his direct testimony that any ‘828 Accused Product “computes numerical parameters that mathematically define an ellipse [REDACTED] [REDACTED] (RIB at 104-05 (citing CX-201C at Q/A 507-86).) Motorola argues that “Apple ignores that portion of its own construction, because as explained in the previous section, its expert admits that [REDACTED] [REDACTED] (RIB at 105.)

Motorola argues that Dr. Balakrishnan’s opinions regarding the Android layer are new. (RIB at 105.) But as with Dr. Balakrishnan’s original opinions, Motorola argues that Dr. Balakrishnan’s new opinions were missing one critically important concept: [REDACTED] [REDACTED] Dr. Balakrishnan did not (and could not) testify that the Android framework actually mathematically fits an ellipse to a pixel group in any Accused ’828 Product. (RIB at 105.) Motorola argues that in Dr. Balakrishnan’s testimony regarding the Android

PUBLIC VERSION

Honeycomb touch driver in the non-test build of the Motorola Xoom, he: “(1) identified the same [REDACTED] that he agreed were not computed by mathematically fitting an ellipse, *see* . . . Tr. 652:15-18; (2) stated, with no additional explanation, that ‘they do some transformations there in the code to turn it into these other five variables shown in yellow,’ *id.* at 652:19-24; (3) stated, with no additional explanation, that ‘a bunch of further calculations happen in the big box before the blue boxes there, the big rectangle above, various different things are done to that code—sorry, those variables,’ *id.* at 653:25-654:4; and (4) opined, without any additional explanation, that this ‘provid[es] a bunch of different ellipse variables,’ *id.* at 654:14-15.” (RIB at 106.)

Having carefully reviewed the evidence and the parties’ arguments, the ALJ agrees with Motorola that the non-test build Xoom does not literally meet the “mathematically fit(ing) an ellipse to one more pixel groups” limitation of the asserted claims. It is undisputed how the devices operate. Apple appears to concede that the Atmel chip itself [REDACTED] [REDACTED] under any construction (although Apple shifted backwards slightly in its reply brief and appears to contend that the Atmel chip by itself meets this limitation). As set forth *supra*, the evidence shows that the Atmel chip [REDACTED]

[REDACTED] In any event, Dr. Balakrishnan did not explain in his testimony how the measurements performed in the Atmel chip (even the derivation of the [REDACTED])

Apple’s new contention is that once the information derived from these measurements reach the Android layer of the operating system of the Accused ’828 Products mathematical fitting is performed by the Android layer or some combination of the Android Layer and Atmel chip. The ALJ finds that simply does not amount to “mathematically fit(ing) an ellipse” either. As Motorola explained, the Android layer [REDACTED]. It

PUBLIC VERSION

has no information regarding [REDACTED] even from the limited data it receives from [REDACTED]
[REDACTED]

However, there are other problems with this theory. First, Dr. Balakrishnan's testimony is severely undercut because this theory regarding the Android layer was not presented (besides some passing citations to the Android source code) in his direct witness statement and this new theory appears to contradict his direct witness statement. Second, some of the evidence cited by Apple, such as [REDACTED] is irrelevant. The [REDACTED] has almost nothing to do with the accused products. While [REDACTED] can receive data from the Atmel chip [REDACTED] it is undisputed that with sufficient position information that an ellipse could be drawn with little problem. Any discussion of extraneous software that is in no way implemented in the Accused '828 Products is irrelevant. As for [REDACTED] Dr. Balakrishnan fails to line up [REDACTED] [REDACTED] to show ellipse fitting through a mathematical process. Rather the evidence shows that [REDACTED] [REDACTED] [REDACTED] (Tr. 603:24-604:14; 607:24-608:4; 654:21-22.)

The evidence shows that the Android operating system "do[esn't] do anything at all resembling" mathematically fitting an ellipse, (Tr. 1045:22-1046:11), and Android does not provide applications with information regarding [REDACTED] of touch events because "we don't have any information about [REDACTED] available." (*Id.* at 1054:5-14.) The evidence further shows that given the information that Android receives from the Xoom firmware, Android is unable to calculate information regarding [REDACTED]. (Tr. 1054:5-19.)

Accordingly, the ALJ finds that the Motorola Xoom does not literally infringe the claims of the '828 Patent because it does not "mathematically fit an ellipse" to the pixel groups.

PUBLIC VERSION

b) Motorola Xoom (Test Build) and the Remaining Accused '828 Products

Motorola has modified the source code for the Motorola Xoom in a “test build” where the [REDACTED] and several variables have been renamed. (CIB at 63; RIB at 96.) The parties agree that the operation of the Xoom Test Build is described on RDX-12.3 and RDX-12.4. (CIB at 63.) In the Xoom Test Build, the only values reported to the Android operating system are [REDACTED] (CIB at 63; RIB at 93.) As shown on RDX-12.4, [REDACTED] is used to provide a value for `getPressure()`, [REDACTED] is used to provide a value for `getSize()`, [REDACTED] provide values for `getX()` and `getY()`, and values for the other `MotionEvent` methods [REDACTED] (CIB at 63; RIB at 93-94.) In addition, Motorola has modified the source code for an additional product, the Droid X, in another “test build.” The operation of the Droid X Test Build is almost identical to the Xoom Test Build, and it is described on RDX-12.7 and RDX-12.8. (CIB at 65 (citing Tr. 662:16-665:4).)

Apple argues that “[t]he Motorola Xoom Test Build literally infringes the ‘mathematically fitting an ellipse’ limitation under Apple’s construction because it computes numerical parameters that mathematically define an ellipse in conjunction with default values for other ellipse parameters, which is similar to the second embodiment described in column 27 of the ’828 Patent specification.” (CIB at 63 (citing CX-201C at Q/A 533).) Apple argues that [REDACTED] is nearly identical to using total group proximity as an indicator of size in the second embodiment.” (CIB at 63 (citing JX-3 at 27:1-3).) Apple argues that [REDACTED] (CIB at 63.) Apple argues that the Droid X (test build) literally infringes the “mathematically fitting an ellipse” limitation under Apple’s

PUBLIC VERSION

construction for the same reasons as the Xoom (test build). (CIB at 65 (citing CX-201C at Q/A 533).)

In the '828 Accused Products (other than the Motorola Xoom),⁹ the [REDACTED] is not used, so the ellipse fitting in these products is similar to the Xoom Test Build. The operation of these products is described on RDX-12.5 and RDX-12.6. (CIB at 64; RIB at 93.) The values for getX(), getY(), and getSize() are similar to that in the Xoom Test Build, but instead of [REDACTED] [REDACTED] these parameters are computed by [REDACTED]. (CIB at 64 (citing RDX-12.6).)

Apple argues that “[t]his is even more similar to the second embodiment described in column 27 of the '828 Patent specification, because the product of amplitude and area is analogous to the ‘total group proximity’ of a pixel group, and since the getTouchMajor() and getTouchMinor() values are computed [REDACTED] [REDACTED] (CIB at 64.) Apple argues that “[t]hese products thus literally infringe the ‘mathematically fitting an ellipse’ limitation under Apple’s construction.” (CIB at 65 (citing CX-201C at Q/A 533).) Apple argues that even though the getTouchMajor() and getTouchMinor() values [REDACTED] in the test build products, they [REDACTED] [REDACTED] and “this is similar to the use of a generic size parameter described in the second embodiment of ellipse fitting in the '828 Patent.” (CRB at 21.) Apple argues that “Dr. Westerman and Dr. Balakrishnan both characterized the second embodiment, where only a centroid and size parameter are computed, as defining a circle, which is a special case of an ellipse.” (CRB at 21 (citing Tr. 336:6-9; CX-201C at Q/A 445).) Apple argues that Motorola’s

⁹ Including the Motorola Atrix, Bravo, Charm, Citrus, Cliq 2, Cliq XT/Quench, Defy, Droid, Droid 2, Droid 2 Global, Droid Bionic, Droid Pro, Droid X, Droid X2, Droid 3, Flipout, Flipside, i1, Titanium, and XPRT (CIB at 64.)

PUBLIC VERSION

“test build” products similarly define a circle using the getSize() method. (CRB at 21 (citing Tr. 659:6-660:5).)

Motorola argues that Dr. Balakrishnan conceded at the hearing that there is no literal infringement under *any* party’s proposed construction with respect to the ‘828 Accused Products [REDACTED]. (RIB at 99 (citing Tr. 597:17-23; 711:23-712:12).)

Motorola argues that Dr. Balakrishnan and the named inventors of the ‘828 Patent conceded at the hearing that five distinct parameters are required to fully describe an ellipse. (RIB at 99 (citing Tr. 547:15-25; Tr. 315:1-15; JX-705C at 58:12-22).) Motorola argues that “[t]here is no dispute that for every ‘828 Accused Product except the non-test build of the Motorola Xoom, [REDACTED]

[REDACTED] (RIB at 99 (citing RX-1895C at Q/A 301; Tr. 605:14-609:7).)

Motorola argues that “[n]o matter what happens elsewhere in the [Accused ‘828 Products], and no matter how information is relabeled by Motorola, by Android, or by any applications, the [REDACTED] for all the [Accused ‘828 Products] except the non-test build of the Motorola Xoom is [REDACTED] [REDACTED] and *none* of these values provide any information regarding shape or orientation.” (RIB at 101 (citing RX-1895C at Q/A 301; Tr. 608:8-15).)

Motorola argues that all products (other than the non-test build Motorola Xoom) that do not compute [REDACTED] “does not literally meet Apple’s proposed construction for ‘mathematically fitting an ellipse to at least one of the pixel groups’ because [REDACTED] [REDACTED] (RIB at 101

(emphasis in the original).)

PUBLIC VERSION

Motorola argues that “Dr. Balakrishnan agreed that no mathematical ellipse-fitting occurs [REDACTED].” (RIB at 105 (citing Tr. 618:6-25; 623:24-624:12)) But Motorola argues that this is the [REDACTED] [REDACTED] (RIB at 105 (citing Tr. 579:20-580:20), and this was [REDACTED] [REDACTED] that Dr. Balakrishnan actually identified in his witness statement as allegedly “mathematically fitting an ellipse to at least one of the pixel groups,” CX-201C, Balakrishnan Q/A 526; 560-61; 575-76. Motorola argues that “[t]he fact that Dr. Balakrishnan agreed that [REDACTED] [REDACTED] (for the one [Accused ’828 Product] that [REDACTED] requires a finding of non-infringement, because the calculation of these values [REDACTED] in the Accused ’828 Products] that Dr. Balakrishnan accused of ‘mathematically fitting an ellipse to at least one of the pixel groups’ in his witness statement in this investigation.” (RIB at 105.)

Motorola characterizes Apple’s new infringement theory as “the mere fact that Android provides measured position, size, and peak pressure information to applications constitutes *mathematically fitting an ellipse to a pixel group* because position and size information *could* be used to describe a circle.” (RIB at 107-108 (emphasis in the original).) Motorola argues that “Dr. Balakrishnan did not identify any portion of the Android code that [REDACTED] in his entire testimony about the Xoom test build. . . .” (RIB at 108.)

Motorola argues that for the test build products [REDACTED] [REDACTED] so there cannot possibly be infringement. (RIB at 109.) Motorola argues that setting `getTouchMajor` and `getTouchMinor`, “the major/minor axes” of an ellipse model in the Android framework, [REDACTED]

PUBLIC VERSION

██████████ (RIB at 109.) Indeed, Motorola points out that Dr. Westerman testified that “regardless of what the equations originally put out, we don’t let the numbers [for major/minor radius] go below 5 or 6 millimeters . . . and then those get transmitted as like a 5 or 6 millimeter circle throughout the system.” (RIB at 109 (quoting Tr. 342:9-18).)

The ALJ agrees with Motorola that there can be no literal infringement by the test build products of any of the asserted claims because they do not “mathematically fit an ellipse.” The evidence shows that ██████████

██████████ (RX-1895C at Q&A 75, 88.) As discussed above, these values are simply measurements made by ██████████. There is simply no ellipse mathematically fit to determine these values. (RX-1895C, Wolfe Q/A 295; RX-1879C, Simmons Q/A 20-22; Brown, Tr. 1045:22-1046:10.) Even when these values are coupled with the getTouchMajor and getTouchMinor in the Android code, there is no ellipse fitted, even under Dr. Balakrishnan’s “ellipse model” theory because even taking all of these values together ██████████

██████████ there is nothing elliptical about the result ██████████
██████████ (RX-1895C Q/A 301, Tr. 608:8-15.) An ellipse cannot have both ██████████
██████████. It is not an ellipse; it is not a circle. It is undisputed that the other values – ██████████ and no fitting occurs to determine them. (RX-1895C at Q/A 78-79.) Moreover, ██████████ bears no relation to any elliptical parameter and does not suggest any fitting of an ellipse. Accordingly, the ALJ finds for that the test build products do not literally infringe any of the asserted claims of the ’828 Patent.

The ALJ also agrees that there is no literal infringement of the Motorola Handset

PUBLIC VERSION

products.¹⁰ Apple has failed to show that any part of the code mathematically fits an ellipse to the pixel group. Neither Dr. Balakrishnan nor Apple ever identified the actions of the Android code layer as meeting this element in their pre-hearing testimony or statements. Such a dramatic change in theory (as discussed above) seriously undermines the credibility of the theory and testimony supporting it.

However, even considering Apple's new infringement theory regarding the operations performed by the Android code, the Motorola Handset products still do nothing that even resembles "mathematically fit(ting) an ellipse" to one or more pixel groups. The values for `getTouchMajor` and `getTouchMinor` are calculated [REDACTED]. The ALJ agrees with Motorola that the resulting numerical parameters share only a superficial relationship to an ellipse and regardless, Apple presented insufficient evidence that the resulting values actually define an ellipse [REDACTED]. The [REDACTED] are simply measured from the sensors. At no time, is any ellipse fitted to the underlying pixel data in the Motorola handsets to calculate any values. Moreover, the [REDACTED] are not ellipse parameters and provide no information of [REDACTED]. [REDACTED]. Apple presented no evidence that any kind of [REDACTED] as required by the ALJ's construction.

Furthermore, even if the "second embodiment" was considered to be ellipse fitting, the ALJ agrees with Motorola that [REDACTED] is a very different value than what the '828 Patent calls "total group proximity." (See RX-1895C at Q/A 79.) The ALJ agrees that according to the '828 Patent, "total group proximity" is the sum of proximity values for an entire contact.

¹⁰ The Motorola Handset products are: Motorola Atrix, Bravo, Charm, Citrus, Cliq 2, Cliq XT/Quench, Defy, Droid, Droid 2, Droid 2 Global, Droid Bionic, Droid Pro, Droid X, Droid X2, Droid 3, Flipout, Flipside, i1, Titanium, and XPRT.

PUBLIC VERSION

(See JX-3 at 26:12-13 (“total group proximity G_z integrates proximity over each pixel in the group”).) Thus, the [REDACTED] would not infringe even if that was included.

Accordingly, the Motorola Handset products do not literally infringe any of the asserted claims of the '828 Patent.

c) Doctrine of Equivalents

Apple admits that the Motorola Xoom would not infringe under Motorola's and Staff's construction but meets this limitation under the Doctrine of Equivalents. (CIB at 62.) Apple argues that the Motorola Xoom computes numerical parameters that mathematically define an ellipse, and these parameters define an ellipse using the same classical ellipse parameters described in the '828 Patent. (CIB at 62.) Apple argues that “[t]he computation of these parameters performs the same function of characterizing the position, shape, and size of a contact, characterized as an ellipse, in the same way by using mathematical computations, with the same result of numerical values that provide the X position, Y position, major axis, minor axis, and orientation of an ellipse.” (CIB at 62 (citing CX-201C at Q/A 535).) Apple concludes, therefore, that “[t]he formulas used to define these parameters in the Motorola Xoom are insubstantially different from those described in the '828 Patent.” (CIB at 62.)

Apple argues that “[t]he second embodiment in the '828 Patent explicitly describes this type of process as equivalent to ellipse fitting.” (CIB at 64 (citing JX-3 at 27:1-8).) Apple further argues that [REDACTED] [REDACTED] performs the same function of characterizing the position, shape, and size of a contact, in the same way by using mathematical computations, with the same result of numerical parameters that mathematically define an ellipse.” (CIB at 64 (citing CX-201C at Q/A 535).) Apple argues that all of the Accused '828 Products infringe the

PUBLIC VERSION

asserted claims of the '828 Patent under the Doctrine of Equivalents under any construction. (CIB at 64.)

Apple argues that its claims under the Doctrine of Equivalents are not barred by prosecution history estoppel as Motorola and Staff argue because Motorola and Staff's arguments are "based on an incorrect reading of the prosecution history and a misinterpretation of what is disclosed in Bisset '352." (CRB at 21-22.) Apple argues that any amendments were merely "tangential" and therefore did not limit the scope of equivalents in this case. (CRB at 22.) Apple argues that "[t]he amendment at issue here, where the applicants added the word "mathematically" to claims 1 and 10, rebuts any prosecution history estoppel because the rationale underlying this amendment is tangential to the equivalent ellipse fitting processes in the '828 Accused Products."

Apple argues that "the applicant did not distinguish "mathematically fit(ing) an ellipse" from other methods of fitting an ellipse." (CRB at 22 (citing CX-568C at Q/A 468).) Apple argues that the "applicant explained that 'merely *obtaining* measured data is [not] the same as *fitting an ellipse to the data. . .*,'" and that the amendment does not describe obtaining measured data as a process for computing parameters but refers to the "measured data" in Bisset '352 as "simply a series of capacitance values." (CRB at 22-23.) Apple argues that "this only distinguishes the ellipse fitting step from the data acquisition steps that precede ellipse fitting." (CRB at 23.) Based on this characterization, Apple argues that "[t]his distinction is tangential to the equivalents accused by Apple, where [REDACTED] [REDACTED] that mathematically define an ellipse." (CRB at 23.)

PUBLIC VERSION

Apple argues that Dr. Wolfe's testimony comparing various processes in Bisset '352 with the computation of parameters in the '828 Accused Products is irrelevant because "the prosecution history contains no reference to these computations and identifies a different reason for amending the claims." (CRB at 23.) Apple argues that the same arguments apply to Motorola's argument estoppel assertion and means-plus function arguments. (CRB at 23.)

Motorola argues that as explained by Dr. Wolfe in his witness statement, the accused functionalities of the Accused '828 Products do not perform substantially the same function, in substantially the same way, to achieve substantially the same result, as the literal recitation of this element under Motorola's and the Staff's proposed construction. (RX-1895C at Q/A 298.)

Motorola argues that no Accused '828 Product [REDACTED]

[REDACTED]. (RIB at 115.) Motorola argues that as explained by Dr. Wolfe and by Martin Simmons of Atmel, the accused functionalities of the Accused '828 Products— [REDACTED]

[REDACTED]—have nothing whatsoever to do with [REDACTED]. (RIB at 115 (citing RX-1895C at Q/A 298; RX-1879C at Q/A 27).) Motorola further argues that [REDACTED]

[REDACTED]. (RIB at 115 (citing RX-1895C at Q/A 298; RX-1879C at Q/A 20-21).) Moreover, Motorola argues that the Android framework [REDACTED] Tr. 579:20-580:20, and it does not [REDACTED] in the Accused '828 Products, as explained by Jeff Brown of Google. (Tr. 1045:22-1046:10.)

The ALJ finds that with respect to the test builds for the Motorola Xoom and the Droid X and the Motorola Handset products, Apple has failed to show that these products infringe under

PUBLIC VERSION

the Doctrine of Equivalents. The evidence shows that these products, [REDACTED] simply do not in any way fit an ellipse to pixel data. (RX-1895C at Q/A 302.) They merely [REDACTED] (Id.) Apple has made no showing that this is equivalent to “mathematically fit(ing) an ellipse.” As discussed above, even giving full credit to Dr. Balakrishnan’s arguments, it is not even possible to construct an ellipse based on the information provided – it is impossible to construct an ellipse with [REDACTED]. Thus, the information provided from the measurements bear no resemblance to [REDACTED]. The test build products do not function in the same way or obtain the same result. Accordingly, they cannot infringe under the doctrine of equivalents.

As for the Motorola Handset products, the values for the major and minor axes [REDACTED]. But, as discussed above, the values for the major and minor axes bear no relation to the underlying pixel group, so there is simply [REDACTED]. This not only poses a problem for literal infringement, but also for infringement under the Doctrine of Equivalents, namely the Motorola Handset products simply do not function in the same way as required by the claims. There is still [REDACTED] even if Dr. Balakrishnan’s testimony was accepted on this point. There is simply no link between the way the device is to function under the asserted claims– mathematically fitting an ellipse – and the calculations that are performed in the Motorola Handset products. Accordingly, they do not infringe under the Doctrine of Equivalents.

The final product to consider is the Motorola Xoom that includes the [REDACTED]. For this product, the [REDACTED]. However, as discussed above, even with the [REDACTED]

PUBLIC VERSION

█ these devices still do not mathematically fit and ellipse to the pixel group. The ALJ finds that while it is a much closer case, the evidence presented by Apple of infringement under the Doctrine of Equivalents is insufficient. Accordingly, the Motorola Xoom products do not infringe under the Doctrine of Equivalents.

It is Apple's burden to establish infringement through the doctrine of equivalents, and Dr. Balakrishnan's entire testimony on this issue comprises *one sentence* in his witness statement (repeated for each claim) in which he asserts:

[F]or the products that do not have the █ parameters, if they are not found to infringe literally under Apple's . . . proposed construction for "mathematically fitting an ellipse," it is my opinion that they infringe under the doctrine of equivalents because █ is performing the same function of characterizing the position, shape, and size of a contact, in the same way by using mathematical computations, with the same result of numerical parameters that mathematically define an ellipse.

(CX-201C at Q/A 535.) Dr. Balakrishnan's equivalents analysis is inadequate. The ALJ agrees with Motorola's argument that his analysis simply fails to demonstrate that the equivalent █. In the absence of any meaningful testimony on this point, Apple cannot carry its burden.

d) Prosecution History Estoppel

But even if Apple had presented sufficient evidence for infringement under the Doctrine of Equivalents, the ALJ finds that any equivalents for the claim element of "mathematically fit(ting) and ellipse" would be barred by prosecution history estoppel. Motorola argues that Apple is estopped from asserting the doctrine of equivalents with respect to the limitations "mathematically fit[ting] an ellipse to at least one of the [one or more] pixel groups" in claims 1 and 10 and the limitation "means for fitting an ellipse to at least one of the pixel groups" in claim 24. (RIB at 110 (citing RX-1895C at Q/A 271-81; JX-6 at 1454-72).) Motorola argues that the

PUBLIC VERSION

limiting amendments to claims 1 and 10 created a presumption of prosecution history estoppel with respect to the ellipse-fitting limitations of these claims, and Apple has not rebutted this presumption. (RIB at 110.) Motorola further argues that remarks to the PTO regarding the scope of the ellipse-fitting limitations of claims 1, 10, and 24 created argument estoppel for these limitations. (RIB at 110.) Motorola argues that this argument estoppel bars Dr. Balakrishnan's theory of equivalency with respect to the ellipse-fitting limitations of the '828 patent, because Dr. Balakrishnan's theory of equivalency seeks to recapture the precise subject matter distinguished by the applicants in their remarks to the PTO. (RIB at 110.)

Motorola argues that the amendment adding the limitation "*mathematically*" would be understood by a person of ordinary skill in the art to narrow the subject matter of claims 1 and 10. (RIB at 110.) Motorola argues that this created a presumption of prosecution history estoppel and the presumptive surrender of *all* equivalents with respect to the narrowed limitations. (RIB at 110 (citing *Honeywell*, 370 F.3d at 1141-44).)

The ALJ agrees with Motorola. Apple could rebut this presumption of prosecution history estoppel and complete surrender of equivalents by showing one of three things—either:

- [1] that the alleged equivalent would have been unforeseeable at the time of the narrowing amendment,
- [2] that the rationale underlying the narrowing amendment bore no more than a tangential relation to the equivalent in question, or
- [3] that there was some other reason suggesting that the patentee could not reasonably have been expected to have described the alleged equivalent.

Honeywell, 370 F.3d at 1144.

It is the patentee's burden to rebut a presumptive surrender of equivalents. See *Honeywell*, 370 F.3d at 1144. Motorola argues that its expert has testified that one of ordinary skill in the art would understand the amendments to the ellipse-fitting limitations of claims 1 and

PUBLIC VERSION

10 to narrow the scope of the claimed subject matter. (RX-1895C at Q/A 279; 297; & 302.) But Apple has not provided any testimony to rebut this presumption.

Motorola argues that even if Apple did offer evidence that Apple could have not rebutted this presumption had it attempted to do so. (RX-1895C at Q/A 297 & 302.) Motorola's expert, Dr. Wolfe, explained in his witness statement:

none of the three [*Honeywell*] factors is present with respect to the December 24, 2009 Office Action rejecting each asserted claim of the '828 Patent based on Bisset '352, or the February 24, 2010 Amendments and Remarks responsive to this Office Action. In particular, Bisset '352 not only bears more than a "tangential" relationship to the equivalent sought to be claimed by Apple—

[REDACTED] —Bisset

'352 actually discloses calculating near-identical values.

(*Id.*) Motorola argues that Dr. Wolfe's witness statement explained in detail exactly where and how Bisset disclosed calculations that bore a close relationship to each of the Atmel values that comprise Dr. Balakrishnan's equivalence theories of infringement. (*See id.*)

Apple's argument relies heavily on its assertion that any amendment was merely tangential to the equivalents in question. (CRB at 22.) Apple argues that the prior art references simply fail to disclose any ellipse model, so there was no surrender of equivalents. However, no one reading the prosecution history would reach that conclusion. The examiner rejected the claims in light of Bisset because the prior art taught fitting an ellipse to one or more pixel groups. While the applicants disagreed that Bisset disclosed this limitation, they amended the claims to recite that the "fitting" was done mathematically. The ALJ finds that the equivalents at issue here go to the heart of this amendment – the way in which the fitting is performed – and therefore the presumption of surrender under *Festo* applies. Because Apple has failed to rebut the presumption of surrender, the ALJ finds that the products do not infringe under the Doctrine of Equivalents.

PUBLIC VERSION

C. The '607 Patent

Apple argues that the '607 Accused Products either literally infringe or infringe under the doctrine of equivalents claims 1-7 and 10. (CIB at 92.) Motorola argues that none of its accused products infringe any of the asserted claims. (RIB at 20.) Staff argues that the Accused Products infringe claims 1, 2, 3, 6, 7 and 10 but do not infringe claims 4 and 5. (SIB at 60-79.)

1. Claim 1

Apple argues that the '607 Accused Products meet each and every limitation of claim 1 either literally or under the doctrine of equivalents. Apple performs an element by element analysis in its post-hearing brief setting forth its infringement arguments. (CIB at 93-110.) Staff agrees. (SIB at 61-70.)

Motorola argues that its '607 Accused Products do not infringe claim 1 because they do not (1) [REDACTED] either literally or any equivalents; (2) the Accused [REDACTED] Product and Accused [REDACTED]¹¹ do not have [REDACTED] [REDACTED] and (3) the Accused [REDACTED] fail to meet the [REDACTED] limitation. (RIB at 23-32.)

For the reasons set forth below, the ALJ finds that Apple has shown by a preponderance of the evidence that the '607 Accused Products infringe claim 1.

¹¹ [REDACTED]

PUBLIC VERSION

a) Preamble – “A touch panel comprising a transparent capacitive sensing medium configured to detect multiple touches or near touches that occur at a same time and at distinct locations in a plane of the touch panel and to produce distinct signals representative of a location of the touches on the plane of the touch panel for each of the multiple touches, wherein the transparent capacitive sensing medium”

Apple argues that the '607 Accused Products meet this limitation as they all contain transparent panels that are capable of accurately recognizing multiple, simultaneous or near touches. (CIB at 94.) Staff agrees. (SIB at 61-70.) Motorola does not dispute that the Accused Products meet this limitation. (See RIB at 20-39.)

The ALJ finds that Apple has shown by a preponderance of the evidence that the Accused Products meet the preamble. The evidence shows that in each of the '607 Accused Products, the touch panel is connected to a chip, namely a sensor integrated circuit (or “sensor IC”). The physical structure of the touch panels in the '607 Accused Products depicted in the “lens sensor assembly diagrams”. (CX-113; CDX-002.111.) The touch panel contains capacitive sensing elements including transparent, separated lines made of [REDACTED] [REDACTED] (CX-202C at Q&A 256.) The touch panel is connected to a sensor IC manufactured by [REDACTED] (CX-113C; CX-202C at Q&A 256.) Together, the sensor IC and the touch panel form a transparent capacitive sensing medium that meets the limitations of the preamble.

The evidence shows that the touch panel and Sensor IC in each of the '607 Accused Products detect capacitive changes at the intersections between the two sets of conductive lines in the touch panel. (CX-202C at Q.257; CDX-002.131; *see, e.g.*, JX-652C.001, .012; *see also* JX-018C at 84:17-86:14, 179:2-183:25, 189:17-23.) The sensor ICs detect these capacitive changes by scanning one or more rows of intersections at a time and are able to measure all of the intersections in less than one one- thousandth of a second. (JX-652C.009 (“The [sensor IC] uses a unique charge-transfer acquisition engine . . . This allows the measurement of up to 224

PUBLIC VERSION

mutual capacitance nodes in under 1 ms”), JX-652C.012 (“The channels are scanned by measuring capacitive changes at the intersections formed between the first X line and all the Y lines. Then the intersections between the next X line and all the Y lines are scanned, and so on, until all X and Y combinations have been measured.”); CX-202C at Q.208-213, 241-246; Tr. at 976:4-977:23 (confirming that the Atmel chips are designed to accurately report and distinguish between multiple finger touches.) The evidence also shows that Atmel sensor IC and the touch panel in the ’607 Accused Products also support multiple touch gestures like the “pinch to zoom” functionality and the “two-touch gestures” described in the Atmel documentation. (CX-202C at Q.258; CDX-002.132; *see, e.g.*, JX-506.007; JX-652C.021, .038; *see also* JX-018C at 199:8-203:20.)

Therefore, the ALJ finds that the ’607 Accused Products meet the preamble.

b) “first layer having a plurality of transparent first conductive lines that are electrically isolated from one another” and “second layer spatially separated from the first layer and having a plurality of transparent second conductive lines that are electrically isolated from one another”

Apple argues that the ’607 Accused Products meet these limitations as they all contain sense electrodes and drive electrodes that are separated enough to prevent any significant current flow between the lines and can perform the functions required by the claims. (CIB at 99-105.)

Staff agrees. (SIB at 63-69.) Motorola argues that the Accused [REDACTED]

[REDACTED] fail to meet this limitation because the drive electrode layer [REDACTED]

(RIB at 29-31.)

The ALJ finds that Apple has shown by a preponderance of the evidence that the ’607 Accused Products, including [REDACTED], meet these limitations.

PUBLIC VERSION

With regard to the [REDACTED] and [REDACTED] products, the evidence shows that these products meet these limitations – [REDACTED] sense electrodes and drive electrodes as well as [REDACTED] drive electrodes and sense electrodes with the horizontal elements meet the “lines” requirement. (CX-202C at Q&A 226-231, 247-248, 264-284; RX-1895C at Q.61; Tr. 1295:7-1296:11; 1301:24-1302:22.)¹² The evidence further shows that the drive and sense electrodes of the [REDACTED] products are “electrically isolated” under the ALJ’s adopted construction, namely they are separated to prevent any significant current flow between the lines. (CX-202C at Q & A 231-236, 248, 513-515.) Motorola does not dispute this. (RIB at 29-31.)

Regarding the [REDACTED] the evidence shows that, under the ALJ’s construction, the sense electrodes and the drive electrodes are separated to prevent any significant current flow between the lines. (CX-202C at Q & A 247-248, 264-284.)¹³

¹² [REDACTED]

[REDACTED]

[REDACTED]

PUBLIC VERSION

The evidence further shows that the addition [REDACTED]
[REDACTED]

[REDACTED] does not alter the fact that the drive electrodes remain “electrically isolated” from one another. (CX-202C at Q&A 248.) Specifically, the evidence shows that Motorola’s own quality assurance tests require [REDACTED]

[REDACTED]
[REDACTED]

[REDACTED] (JX-667C.008-009 at MOTO-APPLE-0005578653_01574131-132; CX-202C at Q &A 235-236.) This test is even repeated a second time at the phone assembly level. (JX-667C.013, 015 at MOTO-APPLE-0005578653_01574136-138.) Motorola’s quality assurance personnel check for [REDACTED]

[REDACTED] (JX-650C.002 (using a scanning electron microscope to confirm that the drive lines are still electrically isolated from one another); CX-202C.059-060 at Q&A 247-248.)

Therefore, the ALJ finds that Apple has shown by a preponderance of the evidence that the '607 Accused Products meet this limitation.

c) “second conductive lines being positioned transverse to the first conductive lines, the intersection of transverse lines being positioned at different locations in the plane of the touch panel”

The evidence shows that the '607 Accused Products have a plurality of horizontal [REDACTED] rows/X lines that are positioned transverse or crosswise to a plurality of vertical [REDACTED] column/Ylines. (CX-202C at Q&A 285-298, 548-566.) Motorola does not dispute this. (See RIB at 19-31.)

PUBLIC VERSION

d) “each of the second conductive lines being operatively coupled to capacitive monitoring circuitry”

Apple argues that the ‘607 Accused Products meet this limitation because they all contain an [REDACTED] that monitors, senses and responds to changes in capacitance and is connected to both the drive and sense [REDACTED] lines. (CIB at 106-109.) Staff agrees. (SIB at 61-70.) Motorola argues that Apple has failed to show that each of the second conductive lines (whether the sense or drive electrodes) is operatively connected to a capacitive monitoring circuitry and that Apple has only shown that the identified “second conductive line” is operatively connected to an [REDACTED] (RIB at 24-25.) Motorola further argues that

Having conceded that applying a voltage and sensing charge coupling are “necessarily different,” simply alleging that two sets of electrodes are connected to one or another of these “necessarily different” circuits could not establish that each of these electrodes is “operatively coupled” to circuitry that is “configured to detect changes in charge coupling.” A voltage drive circuit is not “configured to detect” anything—this circuit just applies a stimulus. In order to establish his infringement theory for claim 1, Dr. Subramanian needed to prove that “both sets of [REDACTED] lines” are operatively coupled to capacitive monitoring circuitry, which he did not do. Instead, Dr. Subramanian conceded that “[t]he [REDACTED] lines are always drive lines,”—exactly what he testified were “necessarily different in the way they operate” from lines on which “charge is counted.” As Dr. Subramanian agreed, the [REDACTED] drive electrode(s) “never turn around and become sense lines.”

(RIB at 25-26.)

The ALJ finds that Apple has shown by a preponderance of the evidence that the ‘607 Accused Products meet this limitation. The evidence shows that [REDACTED] sends current through one set of [REDACTED] lines (commonly referred to as the “drive lines”) and then uses the other set of [REDACTED] lines to sense and respond to changes in capacitance (commonly referred to as the “sense lines”). The driving and sensing of these lines is coordinated in order to accurately and quickly detect touches across the entire touch panel. (CX-202C at Q.239-242, 301, 516-519, 570.) In order to drive one set of lines and sense the other set of lines in the ‘607 Accused Products, the [REDACTED] is necessarily directly or indirectly electrically connected to both

PUBLIC VERSION

sets of lines—the horizontal [REDACTED] drive row lines and the vertical [REDACTED] sense column lines. (CX-202C at Q.239-242, 301, 516-519, 570.) In fact, the evidence shows direct electrical connections between the sensor IC and the [REDACTED] row and column lines. (RX-1895C at Q &A 49, 61, 72-73; CX-202C at Q&A 204-242, 299-306, 516-519, 567-576; JX-580C.008-.009 [REDACTED] [REDACTED] CX-96 [UBM Teardown Report]; *see also* JX-018C [Cranfill Dep. Tr.] at 84:17-86:14, 179:2-183:25, 189:17-23, 221:25-222:23, 225:24-226:16; JX-652C [REDACTED]

[REDACTED] The evidence shows that the [REDACTED] used in the '607 Accused Products meet the capacitive monitoring circuitry limitation—the [REDACTED] detect touches or near touches by monitoring, sensing, and responding to the touch-induced changes in capacitance between the spatially separated drive and sense [REDACTED] lines. (CX-202C at Q.239-242, 301, 516-519, 570.)

While Motorola's arguments are facially directed at both the sense and the drive lines in the '607 Accused Products, the substance of their argument focuses on the drive lines and whether they are "operatively coupled" to a "capacitive monitoring circuitry." (*See supra.*) Thus, the ALJ finds that Motorola does not actually dispute that the sense lines are operatively coupled to a capacitive monitoring circuitry. Motorola's arguments relating to the drive lines and whether they are "operatively coupled" to a capacitive monitoring circuit" are more appropriately discussed with regard to claims 4 and 5. Claim 1 only requires one set of the two sets of conductive lines be operatively coupled to a capacitive monitoring circuit, which the ALJ has found the '607 Accused Products. (*See* '607 Patent at claim 1.) Furthermore, as set forth above, the ALJ finds that the evidence supports a finding that the '607 Accused Products meet this limitation.

PUBLIC VERSION

Therefore, the ALJ finds that Apple has shown by a preponderance of the evidence that the '607 Accused Products meet this limitation.

e) “wherein the capacitive monitoring circuitry is configured to detect changes in charge coupling between the first conductive lines and the second conductive lines”

Apple argues that the '607 Accused Products meet this limitation because they all contain an Atmel sensor IC that monitors, senses and responds to changes in capacitance. (CIB at 109-110.) Staff agrees. (SIB at 61-70.) Motorola argues that the [REDACTED] products and [REDACTED] products do not meet this limitation because Apple failed to take into account [REDACTED] in its infringement analysis. (RIB at 27-28.) Specifically, Motorola argues that Apple failed “to prove that the '607 Accused Products had capacitive monitoring circuitry ‘configured to detect changes in charge coupling between [REDACTED] [REDACTED] (RIB at 27-28.)

The '607 Accused Products satisfy this limitation of claim 1 because they all contain an [REDACTED] that monitors, senses and responds to changes in capacitance (that is, charge coupling) between the [REDACTED] drive and sense lines. (CX-202C at Q &A 307-313, 577-585.) As Atmel’s datasheets explain, the [REDACTED] used by the '607 Accused Products detect touches or near touches “by measuring capacitive changes at the intersections” between the two sets of conductive [REDACTED] lines. (JX-652C.012; *see also* JX-018C at 84:17-86:14, 179:2-183:25, 189:17-23.) Therefore, the [REDACTED] are capacitive monitoring circuitry (that is, circuitry which is responsive to capacitance). (CX-202C at Q&A 307-313.) The [REDACTED] used by the '607 Accused Products all function similarly for purposes of the

PUBLIC VERSION

'607 Patent. (CX-202C at Q&A 307-313; CX-113; JX-578C; JX-; and JX-; *see also* JX-018C at 221:25-222:23.)

The ALJ finds Motorola's argument to be unpersuasive. In essence, Motorola's argument is based on an extremely limited and narrow interpretation and application of "line," *i.e.*, the vertical sense lines in the [REDACTED] and [REDACTED] [REDACTED] products must be limited to [REDACTED] [REDACTED]. However, Motorola cites no support for its reading. Furthermore, the evidence shows that even with the added features, [REDACTED] [REDACTED] still detects touches by monitoring changes in capacitance between the drive and sense lines. (CX-202C at Q &A 247-248; 307-313, 577-585; JX 652C.012; CX-202C at Q.247-248.)

f) Doctrine of equivalents

Apple argues that if the '607 Accused Products fail to meet the limitations of claim 1 literally, then they meet the limitations under the doctrine of equivalents. (CIB at 99-110.) However, Apple simply states (for each disputed claim and element) that "[t]o the extent that this limitation is not found to be met literally under any of the proposed constructions by any of the '607 Accused Products, this limitation is also met under the Doctrine of Equivalents." (CIB at 93-110.)

The ALJ finds that, by simply making a conclusory statement, Apple has failed to meet its burden of proving infringement under the doctrine of equivalents. *Warner-Jenkinson Co. v. Hilton Davis Chem. Co.*, 520 U.S. 17, 40 (1997) (holding that "[t]he determination of equivalence should be applied as an objective inquiry on an element-by-element basis").

PUBLIC VERSION

2. Claims 2 and 3

Apple argues that '607 Accused Products meet all of the limitations of claims 2 and 4. (CIB at 111.) Staff agrees arguing that the '607 Accused Products contain horizontal X row lines that are perpendicular or nearly perpendicular to the vertical Y column lines. (SIB at 70-71.) Motorola does not specifically dispute that the '607 Accused Products do not meet claims 2 and 3 (*see* RIB at 20-39; RRB at 10-18), however its arguments relating to claim 10 of the '607 Patent can certainly be applied substantively to claims 2 and 3. (RIB at 38-39.) As set forth *infra*, the ALJ finds that the '607 Accused Products meet all of the limitations of claim 10. To the extent that Motorola's arguments related to claim 10's "plurality of spaced apart parallel lines having the same pitch and linewidths" and "substantially perpendicular to the parallel lines of the first transparent conductive layer" can be applied to these claims, the ALJ's reasoning for those limitations applies to claims 2 and 3 as well. (*See infra* Section V.C.6.)

The ALJ finds that the '607 Accused Products meet the limitations of claims 2 and 3. As set forth *supra*, the ALJ found that the '607 Accused Products met all of the limitations of claim 1. (*See* Section V.C.1.) The evidence shows that '607 Accused Products all contain one set of parallel lines that are oriented in the horizontal/"X" direction and another set of parallel lines oriented in the vertical/ "Y" direction. (CX-202C at Q&A 314-324.) The evidence further shows that the '607 Accused Products all have one set of lines oriented in the horizontal/ "X" direction and one set of lines oriented in the vertical/ "Y" direction such that horizontal/ "X" lines are perpendicular or nearly perpendicular to the vertical/ "Y" lines. (CX-202C at Q&A 325-334.) Therefore, the ALJ finds that the '607 Accused Products meet the limitations of claims 2 and 3.

Apple also argues that if the '607 Accused Products fail to meet the limitations of claims 2 and 3 literally, then they meet the limitations under the doctrine of equivalents. (CIB at 111.)

PUBLIC VERSION

However, Apple simply states (for each disputed claim and element) that “[t]o To the extent that these limitations are not found literally in the ’607 Accused Products [...], they are met under the Doctrine of Equivalents.” (CIB at 111.)

The ALJ finds that, by simply making a conclusory statement, Apple has failed to meet its burden of proving infringement under the doctrine of equivalents. *Warner-Jenkinson Co.*, 520 U.S. at 40 (holding that “[t]he determination of equivalence should be applied as an objective inquiry on an element-by-element basis”).

3. Claims 4 and 5

Apple argues the ’607 Accused Products meet the limitations of claims 4 and 5 as they all contain [REDACTED]

[REDACTED]
[REDACTED]
[REDACTED]
[REDACTED]
[REDACTED]
[REDACTED] (CIB at 112, 118.)

Motorola argues that the ’607 Accused Products do not infringe claims 4 and 5 because they do not include the claimed lower layer of second conductive lines, each of which is operatively coupled to capacitive monitoring circuitry; or the claimed first glass member disposed over a second glass member. (RIB at 32-35.) Specifically, Motorola argues that Apple has failed to show that the drive electrodes are operatively coupled to a capacitive monitoring circuit. (RIB at 32-33.) Motorola further argues that [REDACTED] fails to meet the “glass member” limitation. (33-35.)

PUBLIC VERSION

Staff argues that, while the '607 Accused Products meet the "glass member" limitation with its layers made of [REDACTED], Apple has failed to show that the '607 Accused Products meet the "disposed over" limitation. (SIB at 71-73.) Specifically, Staff argues that "[i]n order for the '607 Accused Products to infringe Claim 4, the second conductive lines on the second glass member – *i.e.*, the bottom glass member – must be operatively coupled to capacitive monitoring circuit, but they are not." (SIB at 72.)

The ALJ finds that Apple has shown by a preponderance of the evidence that the '607 Accused Products meet each and every limitation of claims 4 and 5. The evidence shows that '607 Accused Products have the "glass member" as construed by the ALJ – the [REDACTED] meets the claim limitation "glass member" as construed by the ALJ. (CX-202C at Q&A 344-45, 352-53, 360-61; *see also supra* at Section IV.D.3 (construing "glass member").) The evidence shows that the '607 Accused Products contain a top [REDACTED] layer that contains a [REDACTED] [REDACTED] layer. (CX-202C at Q & A at 335-345.) The '607 Accused Products also contain a bottom [REDACTED] layer that contains [REDACTED] [REDACTED]. (*Id.* at Q.346-353.) The [REDACTED] is located over/placed on top of the [REDACTED] layer in all of the '607 Accused Products (that is, closer to the surface of the device that normally faces the user in operation and further from the display). (*Id.* at Q.354-361.) Motorola considers the layers of the touch sensor closer to the display screen to be at the "bottom" of the touch sensor build stack and the layers of the touch sensor closer to the touch panel surface (that is, the surface that normally faces the user during operation) to be the "top" of the build stack. (*Id.* at Q.356.)

PUBLIC VERSION

The evidence further shows that the '607 Accused Products all contain a Cover Panel layer made of [REDACTED] that is placed at the top of the touch sensor build stack (that is, as the layer closest to the surface that faces the user during normal operation). (CX-202C at Q &A 366-373.) This Cover Panel layer is located above [REDACTED]

[REDACTED] (CX-202C at Q &A 366-373.)

That is, it is located closer to the surface of the device that normally faces the user in operation and further from the display. The '607 Accused Products also contain [REDACTED]

[REDACTED]

[REDACTED]

[REDACTED]

[REDACTED]. (CX-202C at Q &A 374-387.)

As for Motorola and Staff's arguments, the ALJ finds that the dividing the sensor IC into different circuitry is improper and unsupported by the record. Specifically, the evidence shows that subdividing the sensor IC into different circuitry does not reflect the way that the chips are built and function:

[REDACTED]

[REDACTED]

(JX-17C at 38:7-18) (emphasis added). This is also consistent with how [REDACTED]

actually functions—the chip monitors changes in capacitance between [REDACTED]

[REDACTED] Measuring and monitoring that capacitive charge coupling requires

PUBLIC VERSION

knowing and coordinating which lines are being driven, how those lines are being driven, and what the capacitive effect is on the sense lines—connections to the sense lines alone, without also being connected or coupled to the drive lines, would be insufficient for these circuits to function. (CX-202C at Q&A 238-242, 299-306, 516-519, 570.) As a result, each one of the drive lines and each one of the sense lines are directly connected (and thus, “operatively coupled” under all proposed constructions) to the [REDACTED]. (CX-202C at Q.238-242, 299-306, 516-519, 570.)

Therefore, the ALJ finds that Apple has shown by a preponderance of the evidence that the '607 Accused Products infringe claims 4 and 5.

Apple also argues that if the '607 Accused Products fail to meet the limitations of claims 4 and 5 literally, then they meet the limitations under the doctrine of equivalents. (CIB at 116, 117.) However, Apple simply makes conclusory statements (for each disputed claim and element) that that the '607 Accused Products meet the limitations under the doctrine of equivalents, e.g., “[t]o the extent that the limitations of claim 4 are not found to be met literally under any of the proposed constructions by any of the '607 Accused Products, these limitations are also met by the '607 Accused Products under the Doctrine of Equivalents.” (CIB at 116.)

The ALJ finds that, by simply making a conclusory statement, Apple has failed to meet its burden of proving infringement under the doctrine of equivalents. *Warner-Jenkinson Co.*, 520 U.S. at 40 (holding that “[t]he determination of equivalence should be applied as an objective inquiry on an element-by-element basis”).

PUBLIC VERSION

4. Claim 6

The evidence shows that the conductive lines in all of the '607 Accused Products are made from [REDACTED] (CX-202C at Q&A 388-394, 658-666.) Motorola does not dispute that the '607 Accused Products meet this limitation. (See RIB at 11-48; RRB at 8-26.)

5. Claim 7

The evidence shows that all of of the '607 Accused Products include mutual capacitance touch panels and sensor ICs that recognize touches by sensing or detecting and responding to changes in charge coupling (that is, capacitance) between the two sets of spatially separated conductive lines. (CX-202C at Q &A 395-405, 667-676.) Motorola does not dispute that the '607 Accused Products meet this limitation. (See RIB at 11-48; RRB at 8-26.)

6. Claim 10

Apple argues that the '607 Accused Products meet all of the limitations of claim 10 and argues that most of the limitations of claim 10 are satisfied based on the same functionalities and arguments described with respect to claims 1-7. (CIB at 120.) Apple argues that only two limitations need be addressed that were not addressed previously, namely "a transparent touch panel allowing the screen to be viewed therethrough and capable of recognizing multiple touch events that occur at different locations on the touch panel at a same time and to output this information to a host device to from a pixilated image" and "a first glass member disposed over the screen of the display...a second glass member disposed over the first transparent conductive layer...a third glad member disposed over the second transparent conductive layer." (CIB at 120-125.) Apple argues that the '607 Accused Products all contain lens sensor assemblies and sensor ICs that recognize multiple touch events and the information taken from these touch events that is sent to the device takes the form of an array of picture element values representing

PUBLIC VERSION

the touch panel. (CIB at 122.) Apple further argues that the '607 Accused Products include [REDACTED]

[REDACTED] (CIB at 124.) Staff agrees that the '607 Accused Products practice each and every limitation of claim 10. (SIB at 74-79.)

Motorola argues that the '607 Accused Products do not meet the “first glass member” and “second glass member” limitations; [REDACTED] do not meet the “first transparent conductive layer comprising a plurality of spaced apart parallel lines having the same pitch and linewidths”; and [REDACTED] do not meet “a second transparent conductive layer comprising a plurality of spaced apart parallel lines having the same pitch and linewidths” that are “substantially perpendicular to the parallel lines of the first transparent conductive layer.” (RIB at 36-39.)

Motorola further argues that Apple failed to separately address claim limitations in claim 10 that are not present in claim 1 and that such limitations “present distinct non-infringement positions for the '607 Accused Products.” (RRB at 17-18.) By way of example, Motorola cites the “plurality of spaced apart parallel lines having the same pitch and linewidths.” (RIB at 18.) However, as set forth *supra*, Apple addressed Motorola’s non-infringement arguments with respect to this limitation in addressing claims 2 and 3. (See Section V.C.2.) Thus, Motorola’s arguments are inapposite as Apple has addressed many of the limitations in claim 10 in addressing infringement of claims 1 through 7, *i.e.*, Apple’s argument relies on its analysis for claims 1 through 7 and not just claim 1 as asserted by Motorola.

PUBLIC VERSION

The ALJ finds that the evidence shows that the '607 Accused Products meet each and every limitation of claim 10. (CX-202C at Q&A 406-499.) Indeed, many of the limitations in claim 10, while not exactly the same in specific wording, are similar (in substance) to the limitations set forth in claims 1 through 7. As for those limitations not specifically addressed in claims 1 through 7, the evidence shows that '607 Accused Products meet these limitations, namely the "parallel lines having the same pitch and linewidths," "substantially perpendicular to the parallel lines," "pixilated image" and "glass member" limitations.

a) "a plurality of spaced apart parallel lines having the same pitch and linewidths"/ "a plurality of spaced apart parallel lines having the same pitch and linewidths, the parallel lines of the second conductive layer being substantially perpendicular to the parallel lines of the first transparent conductive layer"

The evidence shows that comparing the overall sense or drive [REDACTED] line to any other line in the same layer shows that the lines are parallel within the layer and perpendicular to the lines in the other layer. (CX-202C at Q&A 231-233, 247 248, 314-334; *see also supra* Section V.C.2 (discussing claims 2 and 3).) Furthermore, the claims specifically state that the lines be "substantially parallel" (claim 2) and "substantially perpendicular" (claims 3 and 10). (JX-2 at Claims 2, 3, 10.) The evidence shows that the '607 Accused Products have sense and drive ITO lines that are "substantially parallel" to other lines in the same plane:

PUBLIC VERSION

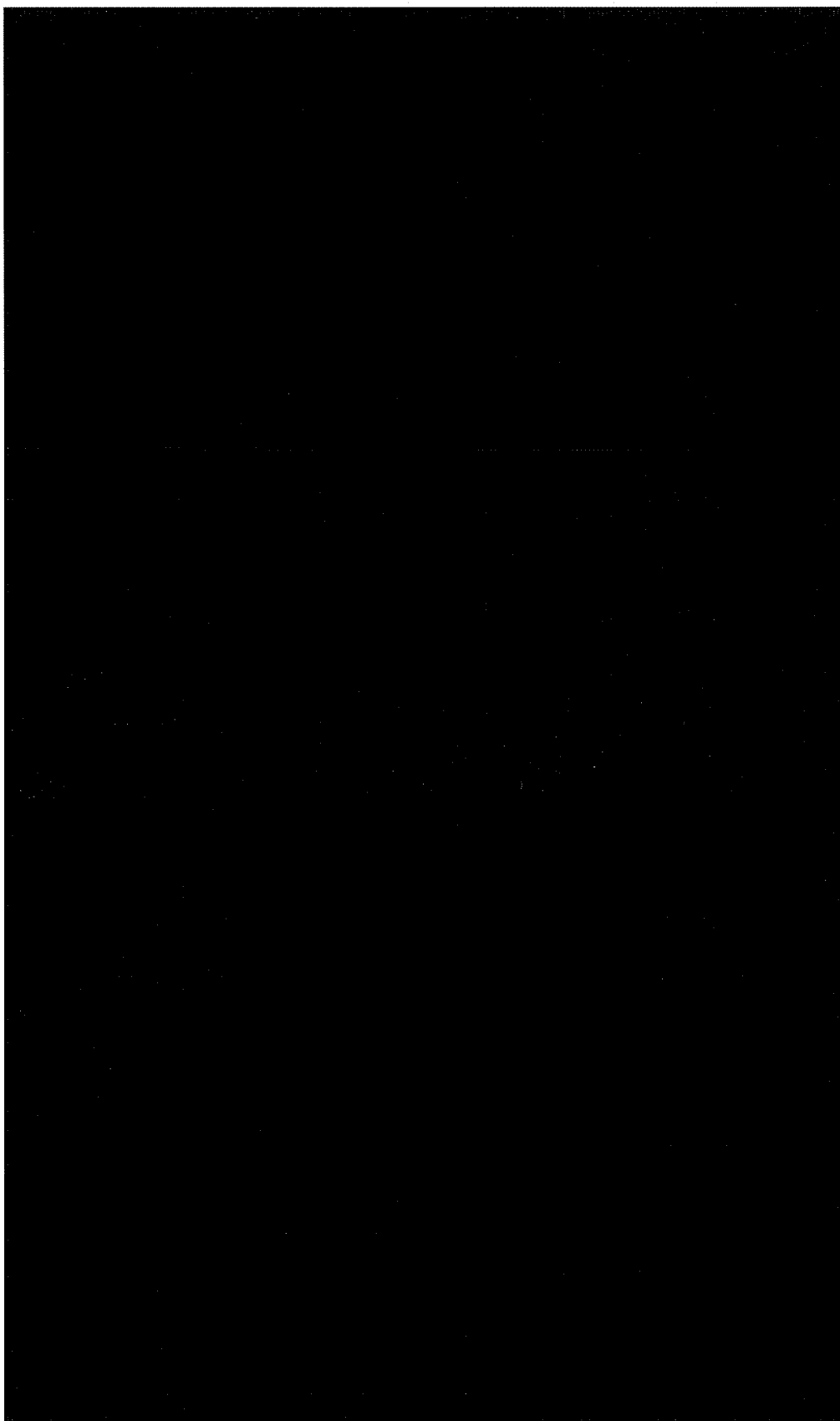

PUBLIC VERSION

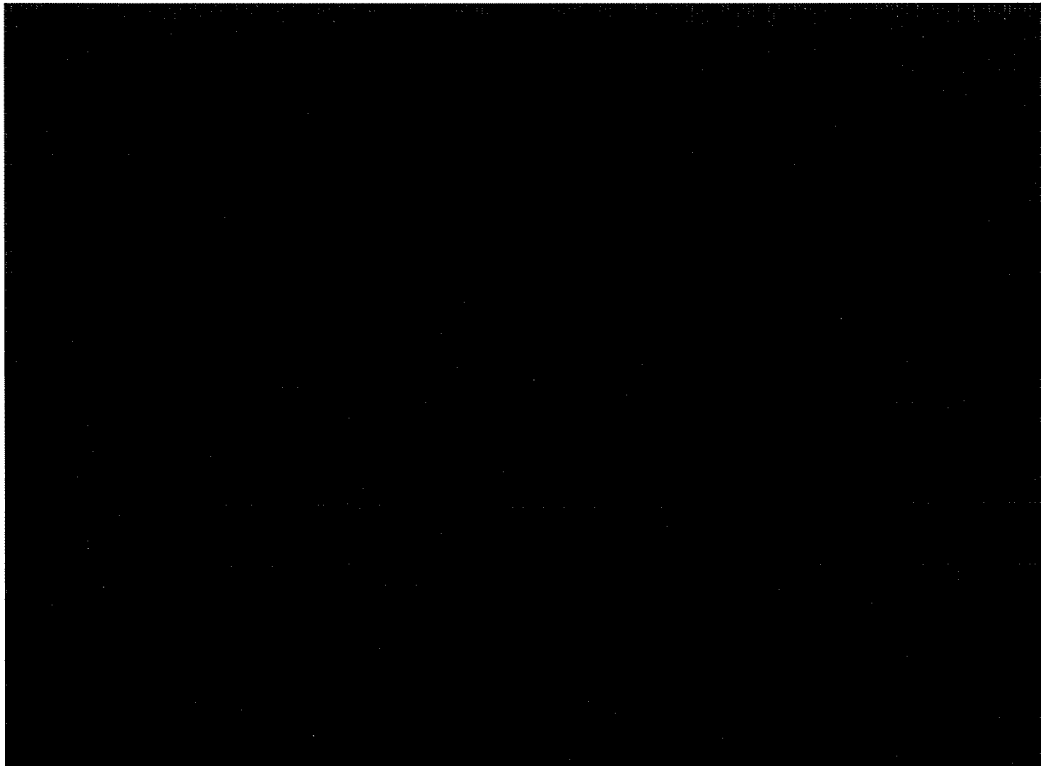

(RDX-1 [Motorola Tutorial], Slide 23-b (depicting the [REDACTED] 24-a (depicting [REDACTED] and 25-a (depicting [REDACTED] [REDACTED] The evidence also shows that the sense and drive [REDACTED] lines are “substantially perpendicular” to lines in the other plane. (JX-626C; JX-675C; JX-612C.) Even with the horizontal appendages in the [REDACTED] and [REDACTED] [REDACTED] the central core line of the sense electrodes in the [REDACTED] products are parallel to each other and perpendicular to the drive lines in the drive line layer. (CX-202C at Q&A 231-233, 247-248, 314-334; *see also* JX-675C; JX-612C.) Therefore, the ALJ finds that the ‘607 Accused Products meet these limitations.

b) “to output this information to a host device to form a pixilated image”

The evidence shows that the ‘607 Accused Products meet the “pixilated image” limitation. The evidence shows that the ‘607 Accused Products all contain a transparent touch panel and a

PUBLIC VERSION

sensor that recognizes multiple touches or near touches across the plane of the touch panel and outputs that information to the phone that uses and responds to the input from the touch panel. (CX-202C at Q&A 243-244, 412-428, 683-695.) When the lens sensor assemblies and sensor ICs in the '607 Accused Products recognize multiple touches or near touches, information about those multiple touch events is sent to the computing device by the touch panel so that the device can respond to the touch input from the user. In the '607 Accused Products, the information about the multiple touch events that is sent to the device takes the form of an array of picture element values representing the touch data from the touch panel. (CX-202C at Q&A 243-244, 412-428; *see, e.g.*, JX-661C.034 [REDACTED]

[REDACTED] *see also* JX-655C; JX-662C.) Although the output from the [REDACTED] in the '607 Accused Products is a [REDACTED], those [REDACTED] can still represent the touch location information for each node or intersection of the touch screen (*i.e.*, the full extent of the touchscreen active region). (CX-202C at Q&A 243-244, 412-428, *See* JX-661C.034.) The evidence further shows that the information about [REDACTED] is sufficient for the phone's host processor to create an image of the touch panel that plots the coordinates of these touch centroids, creating an array of pixel element values each representing touch contacts at particular nodes across the touch screen. (CX-202C at Q.243-244, 412-428; *see* JX-661C.034; Tr. at 1030:17-1031:6.) Therefore, the ALJ finds that the '607 Accused Products meet this limitation.

c) "a first glass member disposed over the screen of the display. . . a second glass member disposed over the first transparent conductive

PUBLIC VERSION

layer. . .a third glass member disposed over the second transparent conductive layer”

The evidence shows that the '607 Accused Products meet the “glass member” limitations set forth *supra*. Motorola’s arguments are inapposite because the ALJ found that “glass member” included glass or plastic element. (See Section IV.D.3.) The evidence shows that the '607 Accused Products include:

[REDACTED]

[REDACTED] (CX-202C at Q&A 214-225, 439-448, 464-474, 491-497.)

Therefore, the ALJ finds that Apple has shown by a preponderance of the evidence that the '607 Accused Products meet each and every limitation of claim 10.

d) Doctrine of equivalents

Apple also argues that if the '607 Accused Products fail to meet the limitations of claim 10 literally, then they meet the limitations under the doctrine of equivalents. (CIB at 125.) However, Apple simply makes a conclusory statement (for each disputed claim and element) that the '607 Accused Products meet the limitations under the doctrine of equivalents, *e.g.*, “[t]o the extent that these limitations are not found to be met literally by any of the '607 Accused Products [. . .], they are met by the '607 Accused Products [. . .]under the Doctrine of Equivalents.” (CIB at 125.)

The ALJ finds that, by simply making a conclusory statement, Apple has failed to meet its burden of proving infringement under the doctrine of equivalents. *Warner-Jenkinson Co.*,

PUBLIC VERSION

520 U.S. at 40 (holding that “[t]he determination of equivalence should be applied as an objective inquiry on an element-by-element basis”).

D. The '430 Patent

Apple accuses the following products of infringing the '430 Patent: Motorola Atrix, Backflip, Bravo, Charm, Citrus, Cliq/Dext, Cliq 2, Cliq XT/Quench, Defy, Devour, Droid, Droid 2, Droid 2 Global, Droid Bionic, Droid Pro, Droid X, Droid X2, Droid 3, Flipout, Flipside, i1, Titanium, Xoom, and XPRT (collectively, “the Accused '430 Products”). (*See* CX201C at Q/A 107 (*citing* CDX-001.040 (table listing accused products)).) Apple alleges that the Accused '430 Products all infringe the '430 Patent because they all run the Android operating system. (*See id.* at Q/A 106, 147-49.)

The ALJ finds that the Accused '430 Products literally infringe claims 1, 3 and 5 of the '430 Patent. There is no factual dispute over how the Android phones perform the four steps of the claimed method. As set forth below, the ALJ finds that the testimony of Motorola’s witnesses, combined with the experts’ analysis and the documents in evidence, show that the Accused '430 Products literally infringe claims 1,3 and 5 of the '430 Patent.

The ALJ has already found that the Preamble is not a limitation and so does not consider it.

1. specifying a target hardware or software component search criteria including one or more properties

Motorola offered two witness statements at the hearing concerning the operation of the Android “implicit intent” resolution functionality, David Boldt (a Motorola engineer), and Dianne Hackborn (a Google engineer). The ALJ finds that the testimony of both witnesses,

PUBLIC VERSION

which were nearly identical, explain how Android's implicit intent resolution meets the steps of this claim limitation.

First, Android is built on the idea that applications are not structured as complete programs, but are conceptualized as a series of components that are added to the operating system one by one, on the fly, during operation. Ms. Hackborn described how applications are broken up into these separate pieces, distinguishing Android from old-style applications on desktop systems. (RX-1869C at Q/A 6-7.) These pieces are described by Google itself as the "components" of the applications, exactly the term that is used in the claims. (JX-692C.003.) These application components include Activities and Services. (RX-1869C at Q/A 7.) Structuring these applications as components that are brought into the operating system on the fly allowed the seamless stringing together of Activities. (*Id.* at Q/A 17.)

Second, the mechanism in Android that allows components to be located on the fly is the "Intent" mechanism. Intents allow Android to interact with applications, for applications to find and interact with other applications, and to launch application components. (RX-1869C at Q/A 27-30.) The intent is a bundle of information that specifies information about the Activity or Service that must be found by the Android framework. (RX-1869C at Q/A 40-44; 47.) When Android needs to start an Activity (and add it to the Activity Stack in the operating system), an intent is used to specify the target Activity.

Android uses "explicit intents" that explicitly name a target Activity. (RX-1869C at Q/A 44; RX-1860C at Q/A 57.) Explicitly naming the target component a prior art technique that is different from the property-search approach of the '430 Patent. Android mainly uses "implicit intents," which do not identify a target component by name. (RX-1869C at Q/A 47.) An implicit intent specifies a target component by the properties of the desired component—its

PUBLIC VERSION

ability to perform an “action,” its “category,” and its ability to handle a certain “data” type. (RX-1869C at Q/A 41, 47, 54, 69.) There is no dispute that implicit intents in Android specify “properties,” as the ALJ construed this term, of a target component. (RIB at 153-154 (only disputing limitation under Apple’s proposed construction).) Motorola’s expert admitted that this functionality meets element (a). (Tr. At 1187:17-1189:4.) Accordingly, the ALJ finds that Accused ’430 Products meet the limitation.

2. querying the operating system to identify one or more hardware or software components that meet the target hardware or software component search criteria

The Android intent resolution process requires querying the operating system. (CX-201C at Q/A 171-183.) In this case, the “query” is within the application framework of Android, and involves the Activity Manager and Package Manager services. As Ms. Hackborn confirmed, the Activity Manager is a system service in the Android Application Framework. (RX-1869C at Q/A 57.) The Package Manager is also a system service in the framework. (*Id.* at Q/A 61.)

The ALJ finds that, as the named inventor explained, the patent uses the term “operating system” extremely broadly, and thus, the Android Application framework is part of the operating system for the purposes of this analysis. (JX-469C at 13:24-14:13 (“In the context of the patent, ‘operating system’ means everything from the desktop to the application layer to the kernel. It’s the same context for the Windows OS or Tal OS.”).) The Package Manager tracks information about the applications that are installed on the phone. (RX-1869C at Q/A 62.) After the Activity Manager specifies the target component by properties, passing the implicit intent to the Package Manager using the `resolveIntent()` method (RX-1869C at Q/A 59), the Package Manager looks at its list of `IntentFilters` to find a match for the target

PUBLIC VERSION

component's properties. (RX-1869C at Q/A 64, 66.) The ALJ finds that this is a query—in fact, the Android system uses a method called *queryIntentActivities()* to locate the right component. (RX-1860C at Q/A 74-79.) Motorola's expert admits that this query meets Apple's and the Staff's proposed constructions for element (b). (Tr. 1189:5-14.) Accordingly, the Accused '430 Products meet the limitation.

3. returning hardware or software components meeting the target hardware or software component search criteria

Apple and Staff argue that the '430 Accused Products return software components meeting the target software component search criteria. The ALJ agrees that the evidence shows that the Package Manager implements a method to locate one or more components that meet the target search criteria. (*See* CX-201C at Q/A 113-138.)

A component or components that are found to be matches for an implicit intent by the Package Manager are added to a list of matching components that may be returned. (*See* JX-557C at MOTO-APPLE-0000335057; JX-015C at 68:11-23.) If there is only one component on the list, the Package Manager can return that component. (*See* JX-557C at MOTO-APPLE-0000335050, 56-57; JX-693C at MOTO-APPLE-003157441-44; JX-557C at MOTO-APPLE-0000335057; MOTO-APPLE-000369220 (“If more than one activity can handle the action and data, the system displays an activity chooser for the user to choose from”); *see also* JX-572C, Android Training, at MOTO-APPLE-0003519462; JX-567C at MOTO-APPLE-0002502601, -12; JX-24C at 69:12-71:15, 80:14-81:2, 83:5-84:17, 122:23-123:8, 126:14-128:10; JX-015C at 72:22-73:13, 81:7-14, 82:11-16 (“Q. So, if you have multiple home screen applications available on the device when you press the home key, your understanding is that it sends an implicit intent that is resolved into a chooser interface? A. Yes”); *id.* at 179:8-22; JX-557C at MOTO-APPLE-0000335056.)

PUBLIC VERSION

As for Motorola's noninfringement argument that the process does not return components under the ALJ's construction, Dr. Locke testified that as part of the intent-resolution process, within the Android operating system, the "Activity Manager" queries the "Package Manager" for Activities (which are components of applications) that match the intent. (Tr. 1195:7-21, 1196:1-12.) Accordingly, the Accused '430 Products meet the limitation

4. adding support for the hardware and software components to the operating system without rebooting the operating system

There are two ways in which support is added to the operating system at the conclusion of the intent resolution process. (CX-201C at Q/A 196-207.) Motorola's witnesses confirmed that Android adds support for Activities and Services. Activities are managed through the Activity Stack. The Activity Stack is a data structure in the application framework. (JX-015C at 74:11-75:6.) The Stack is updated when a new Activity is started. (*Id.* at 75:7-19.) The Stack is updated by **adding** an Activity to the stack. (*Id.*) The Activity Stack is used to manage Activities, and to track which Activity is currently running. (RX-1860C at Q/A 177-178.) Because the Activity has been added to this operating system data structure (as Dr. Balakrishnan has interpreted that term), users can navigate to the Activity without restarting the application. (RX-1860C at Q/A 182.) Dr. Locke admitted that there are pointers and connections that are added to the Activity Stack in the Android operating system during the intent process. (Tr. 1197:13-1198:3.) That is the support that is "added" to the operating system—pointers and connections in the form of data in operating system (as Dr. Balakrishnan and the patent interprets it) data structures, that allow the system to use the components.

PUBLIC VERSION

Support is also added to the operating system (as Dr. Balakrishnan and the patent interprets it) when Services are bound. Activities use the `bindService()` method to connect to Services. (RX-1860C at Q/A 164.) When Services are bound using this method, a connection is made to an Activity that allows the Activity to perform calls on the service. (RX-1860C at Q/A 166.) The `bindService()` method creates a binder object. (JX-015C at 95:8-20, 91:15-20.) That object allows for inter-process communication. (*Id.* at 95:8-20.) Dr. Balakrishnan also testified that addition of the binder object adds support to the operating system (as he has interpreted it for infringement purposes) for the Service. (CX-201C at Q/A 198.)

Motorola's arguments that an installation program is run to perform the claim, and that Activities and Services are somehow fully supported without being launched, and added to the Activity Stack or bound, are without support because there is no dispute that an installation program is not run during the four-step process of the claims (Tr. 1189:21-1190:6) and there is no dispute that the "pointers and connections" that support the system's use of the Activity and are *not* added at the time of installation. (Tr. 1197:20-1198:3.) Accordingly, the ALJ finds the Accused '430 Products meets this limitation.

There are no separate disputes over dependent claims 3 ("system component") and 5 ("application component"). Activity and Service components, which are described as application components by Google and Motorola, meet claims 3 and 5. (CX-201C at Q/A 208-224.)

Accordingly, Motorola's Accused '430 Products infringe the asserted claims of the '430 Patent.

Having made the foregoing findings on whether the accused products infringe the asserted patents, the ALJ finds that the disposition of this material issue, *i.e.*, infringement,

PUBLIC VERSION

satisfies Commission Rule 210.42(d).¹⁴ The ALJ's failure to discuss any matter raised by the parties, or any portion of the record, does not indicate that it has not been considered. Rather, any such matter(s) or portion(s) of the record has/have been deemed immaterial.

VI. VALIDITY

A. Background

One cannot be held liable for practicing an invalid patent claim. *See Pandrol USA, LP v. AirBoss Railway Prods., Inc.*, 320 F.3d 1354, 1365 (Fed. Cir. 2003). However, the claims of a patent are presumed to be valid. 35 U.S.C. § 282; *DMI Inc. v. Deere & Co.*, 802 F.2d 421 (Fed. Cir. 1986). Although a complainant has the burden of proving a violation of section 337, it can rely on this presumption of validity.

Respondents have the burden of proving invalidity of the patent. This “burden is constant and never changes and is to convince the court of invalidity by clear evidence.” *I4i v. Microsoft Corp.*, 131 S. Ct. 2338, 2243 (2010) (citing Judge Rich in *American Hoist & Derrick Co. v. Sowa & Sons, Inc.*, 725 F. 2d 1350, 1360 (CA Fed. 1984)). Respondents’ burden of persuasion *never shifts*. *Id.* The risk of “decisional uncertainty” remains on the respondent. *Technology Licensing Corp. v. Videotek, Inc.*, 545 F.3d 1316, 1327 (Fed. Cir. 2008); *see also PowerOasis, Inc. v. T-Mobile USA, Inc.*, 522 F.3d 1299, 1303, 1305 (Fed. Cir. 2008); *Pfizer, Inc. v. Apotex, Inc.*, 480 F.3d 1348, 1360 (Fed. Cir. 2007). Thus, it is respondent’s burden to prove

¹⁴ Commission Rule 210.42(d) states:

(d) Contents. The initial determination shall include: an opinion stating findings (with specific page references to principal supporting items of evidence in the record) and conclusions and the reasons or bases therefor necessary for **the disposition of all material issues of fact, law, or discretion presented in the record**; and a statement that, pursuant to §210.42(h), the initial determination shall become the determination of the Commission unless a party files a petition for review of the initial determination pursuant to §210.43(a) or the Commission, pursuant to §210.44, orders on its own motion a review of the initial determination or certain issues therein. (emphasis added).

PUBLIC VERSION

by clear and convincing evidence that any of the alleged prior art references anticipate or render obvious the asserted claims of the patents in suit. Failure to do so means that respondents loses on this point. *Id.* (stating, “[I]f the fact trier of the issue is left uncertain, the party with the burden [of persuasion] loses.”).

Respondents also bears the burden of going forward with evidence, *i.e.*, the burden of production. *Id.* This is “a shifting burden the allocation of which depends on where in the process of a trial the issue arises.” *Id.* However, this burden does not shift until a respondent presents “evidence that might lead to a conclusion of invalidity.” *Pfizer*, 480 F.3d at 1360. Once a respondent “has presented a prima facie case of invalidity, the patentee has the burden of going forward with rebuttal evidence.” *Id.*

B. Anticipation

A patent may be found invalid as anticipated under 35 U.S.C. § 102(a) if “the invention was known or used by others in this country, or patented or described in a printed publication in this country, or patented or described in a printed publication in a foreign country, before the invention thereof by the applicant for patent.” 35 U.S.C. § 102(a). A patent may be found invalid as anticipated under 35 U.S.C. § 102(b) if “the invention was patented or described in a printed publication in this or a foreign country or in public use or on sale in this country, more than one year prior to the date of the application for patent in the United States.” 35 U.S.C. § 102(b). Under 35 U.S.C. § 102(e), a patent is invalid as anticipated if “the invention was described in a patent granted on an application for patent by another filed in the United States before the invention thereof by the applicant for patent.” 35 U.S.C. § 102(e). Anticipation is a question of fact. *Texas Instruments, Inc. v. U.S. Int’l Trade Comm’n*, 988 F.2d 1165, 1177 (Fed. Cir. 1993) (“*Texas Instruments II*”). Anticipation is a two-step inquiry: first, the claims of the

PUBLIC VERSION

asserted patent must be properly construed, and then the construed claims must be compared to the alleged prior art reference. *See, e.g., Medichem, S.A. v. Rolabo, S.L.*, 353 F.3d 928, 933 (Fed. Cir. 2003). It is axiomatic that claims are construed the same way for both invalidity and infringement. *W.L. Gore v. Garlock, Inc.*, 842 F.2d 1275, 1279 (Fed. Cir. 2008.)

“Claimed subject matter is ‘anticipated’ when it is not new; that is, when it was previously known. Invalidation on this ground requires that *every element and limitation* of the claim was *previously described in a single prior art reference*, either *expressly or inherently*, so as to place a person of ordinary skill in possession of the invention.” *Sanofi-Synthelabo v. Apotex, Inc.*, 550 F.3d 1075, 1082 (Fed. Cir. 2008) (emphasis added) (citing *Schering Corp. v. Geneva Pharms., Inc.*, 339 F.3d 1373, 1379 (Fed. Cir. 2003) and *Continental Can Co. USA v. Monsanto Co.*, 948 F.2d 1264, 1267-69 (Fed. Cir. 1991)).

To anticipate, a single prior art reference must be enabling and it must describe the claimed invention, *i.e.*, a person of ordinary skill in the field of the invention must be able to practice the subject matter of the patent based on the prior art reference without undue experimentation. *Sanofi*, 550 F.3d at 1082. The presence in said reference of *both* a specific description and enablement of the subject matter at issue are required. *Id.* at 1083.

To anticipate, a prior art reference also must disclose all elements of the claim within the four corners of said reference. *Net MoneyIN, Inc. v. VeriSign, Inc.*, 545 F.3d 1359, 1369 (Fed. Cir. 2008) (“*NMP*”); *see also Abbott Labs. v. Sandoz, Inc.*, 544 F.3d 1341, 1345 (Fed. Cir. 2007) (stating, “Anticipation is established by documentary evidence, and requires that every claim element and limitation is set forth in a single prior art reference, in the same form and order as in the claim.”). Further, “[b]ecause the hallmark of anticipation is prior invention, the prior art reference--in order to anticipate under 35 U.S.C. § 102--must not only disclose all elements of

PUBLIC VERSION

the claim within the four corners of the document, but must also disclose those elements ‘arranged as in the claim.’” *Id.* (quoting *Connell v. Sears, Roebuck & Co.*, 722 F.2d 1542, 1548 (Fed. Cir. 1983)). The Federal Circuit explained this requirement as follows:

The meaning of the expression ‘arranged as in the claim’ is readily understood in relation to claims drawn to things such as ingredients mixed in some claimed order. In such instances, a reference that discloses all of the claimed ingredients, but not in the order claimed, would not anticipate, because the reference would be missing any disclosure of the limitations of the claimed invention ‘arranged as in the claim.’ But the ‘arranged as in the claim’ requirement is not limited to such a narrow set of ‘order of limitations’ claims. Rather, *our precedent informs that the ‘arranged as in the claim’ requirement applies to all claims and refers to the need for an anticipatory reference to show all of the limitations of the claims arranged or combined in the same way as recited in the claims, not merely in a particular order.* The test is thus more accurately understood to mean ‘arranged or combined in the same way as in the claim.’

Id. at 1370 (emphasis added). Therefore, it is not enough for anticipation that a prior art reference simply contains all of the separate elements of the claimed invention. *Id.* at 1370-71 (stating that “*it is not enough [for anticipation] that the prior art reference discloses part of the claimed invention, which an ordinary artisan might supplement to make the whole, or that it includes multiple, distinct teachings that the artisan might somehow combine to achieve the claimed invention.*” (emphasis added)). Those elements must be arranged or combined in said reference in the same way as they are in the patent claim.

If a prior art reference does not expressly set forth a particular claim element, it still may anticipate the claim if the missing element is inherently disclosed by said reference. *Trintec Indus., Inc. v. Top-U.S.A. Corp.*, 295 F.3d 1292, 1295 (Fed. Cir. 2002); *In re Robertson*, 169 F.3d 743, 745 (Fed. Cir. 1999). Inherent anticipation occurs when “the missing descriptive material is ‘necessarily present,’ not merely probably or possibly present, in the prior art.” (*Id.*); *see also Rhino Assocs. v. Berg Mfg. & Sales Corp.*, 482 F. Supp.2d 537, 551 (M.D. Pa. 2007). In

PUBLIC VERSION

other words, inherency may not be established by probabilities or possibilities. *See Continental Can*, 948 F.2d at 1268. Thus, “[t]he mere fact that a certain thing may result from a given set of circumstances is not sufficient.” *Id.*

The critical question for inherent anticipation here is whether, as a matter of fact, practicing an alleged prior art reference necessarily features or results in each and every limitation of the asserted claim at issue. *See, e.g., Toro Co. v. Deere & Co.*, 355 F.3d 1313, 1320 (Fed. Cir. 2004). Such is the case even if one of ordinary skill in the art would not have recognized said inherent anticipation at the time of the invention of the ‘829 Patent. *Id.* at 1320-21.

If there are “slight differences” between separate elements disclosed in a prior art reference and the claimed invention, those differences “invoke the question of obviousness, not anticipation.” *NMI*, 545 F.3d at 1071; *see also Trintec*, 295 F.3d at 1296 (finding no anticipation and stating that “the difference between a printer and a photocopier may be minimal and obvious to those of skill in this art. Nevertheless, obviousness is not inherent anticipation.”). Statements such as “one of ordinary skill may, in reliance on the prior art, complete the work required for the invention,” and that “it is sufficient for an anticipation if the general aspects are the same and the differences in minor matters is only such as would suggest itself to one of ordinary skill in the art,” *actually relate to obviousness*, not anticipation. *Connell*, 722 F.2d at 1548; *see infra*.

1. The ‘828 Patent

a) U.S. Patent No. 5,825,352 – Bisset

Motorola argues that claims 1 and 10 are anticipated by U.S. Patent No. 5,825,352 to Bisset (“Bisset ’352 Patent”). (RIB at 120.) Motorola argues that the Bisset ’352 Patent anticipates claims 1 and 10 under Apple’s proposed constructions as they have been interpreted by Dr. Balakrishnan and applied to the Accused ’828 Products. (RIB at 120.)

PUBLIC VERSION

However, the ALJ has rejected Dr. Balakrishnan's construction of mathematically fit(ing) an ellipse. Motorola offers no evidence that Bisset meets this limitation under any other construction. Accordingly, the ALJ finds that Motorola has failed to prove by clear and convincing evidence that Bisset anticipates claims 1 and 10 of the '828 Patent.

b) Desai Thesis

Motorola next argues that the '828 Patent is anticipated by a Master's Thesis by Apurva Mahendra Desai at Simon Fraser University in Canada that was published in 1994 and entitled *Interpretation of Tactile Data from an FSR Pressure Pad Transducer Using Image Processing Techniques* (the "Desai Thesis"). (RX-351C.) Staff argues that the Desai Thesis does not anticipate the '828 Patent for two reasons: (1) it does not disclose the "segmenting" limitation of any asserted claim and (2) the Desai Thesis does not disclose the contact tracking identification module limitation of claim 10. (SIB at 43-44.)

The ALJ agrees that the Desai Thesis does not disclose the segmenting limitation of all of the asserted claims. The segmenting limitations describe segmenting the proximity data "into one or more pixel groups" representing "distinguishable" hand parts or other touch objects. (CX-568C, Balakrishnan RWS, at Q/A 484-87.) This necessarily means that if one or more object is present, the claimed device or method will be able to identify each as a separate object on the touch sensitive surface. (*Id.*) However, the Desai Thesis states that its processing technique "assumes that only one object is placed on the array at a time" and that "[t]he techniques will have to be redeveloped for more than one object" and that "[t]his could be quite a difficult thing if the objects are placed close to each other." (RX-351 at 117.) Thus, the ALJ finds that the Desai Thesis does not disclose segmenting a proximity image into one more pixel groups.

PUBLIC VERSION

Accordingly, the ALJ finds that Motorola has failed to prove by clear and convincing evidence that the Desai Thesis anticipates the '828 Patent.

2. The '607 Patent

a) Perski '455

(1) *Perski '455 is prior art to the '607 Patent*

Motorola argues that U.S. Patent No. 7,372,455 to Perski, et al. ("Perski '455") entitled "Touch Detection for a Digitizer" was filed on January 15, 2004 and is prior art under 35 U.S.C. § 102(e). (RIB at 48.) Motorola further argues that Perski '455 is entitled to claim priority to U.S. Provisional Patent Application No. 60/446,808 ("the Perski '808 provisional"), which was filed on February 10, 2003. (RIB at 48.) Staff agrees. (SIB at 80-81.)

Apple argues that is entitled to an earlier date of invention – namely that the invention was conceived between September 2003 and November 2003, reduced to practice by December 2003 and was diligently worked on from September 2003 through May 24. (CIB at 127.) Apple further argues that Perski '455 is not entitled to claim priority back to the Perski '808 provisional because Motorola has failed to put forward any specific analysis of matching which portions of Perski '455 are supported by which portions of the Perski '808 provisional. (CIB at 133.)

The ALJ finds that Perski '455 is entitled to claim priority back to the Perski '808 provisional. The evidence shows that Perski '455 finds support in the Perski '808 provisional. (RX-1885C at Q&A 267-69, 305, 317-19 and Appx. A1.) For example, the Perski '808 provisional discloses "utiliz[ing] a patterned transparent conductive foil system . . . in order to enable multiple and simultaneous finger inputs directly on the display" and contains the same figure showing a grid of transparent conductive lines used to detect multiple touches using mutual capacitance as in Perski '455. (RX-303 at 1 ¶ 1; compare RX-303 at fig. 2 with RX-708 at fig. 2.)

PUBLIC VERSION

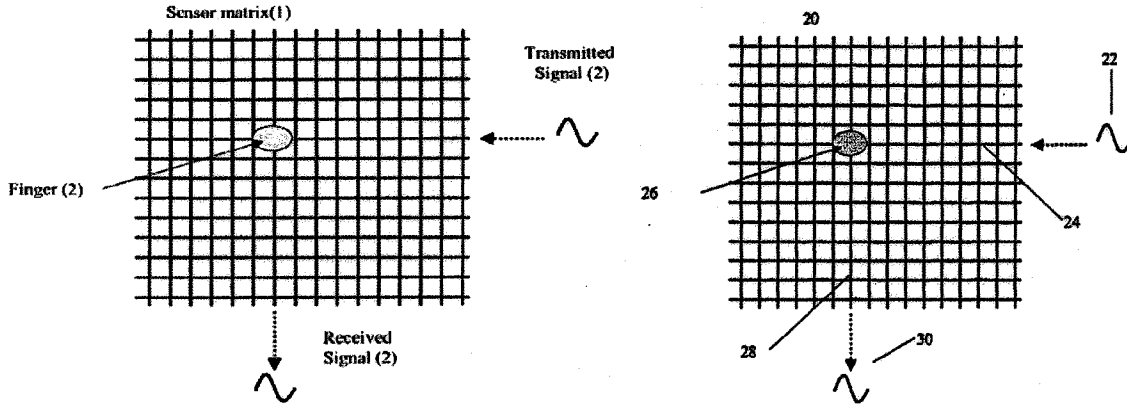

(RX-303 (Perski '808 provisional) fig. 2 and RX-708 (Perski '455 patent) fig. 2.) Another example shows that the Perski '808 provisional discloses a finger detection method in which horizontal lines are driven and vertical lines sensed, while in Perski '455, fingers are detected using a change in mutual capacitance between the drive lines and the sense lines. (Compare RX-303 at 3 ¶ 5 with RX-708 at 13:30-43.) Finally, as in Perski '455, the Perski '808 provisional describes algorithms for use with the transparent mutual capacitance touch sensor to detect multiple, simultaneous finger touches. (Compare RX-303 at 4 ¶ 1-3 with RX-708 at 14:15-59.)

As for Apple's arguments, the ALJ finds that Apple cites no authority to support its contention that a portion by portion analysis need be performed in order for a patent to claim priority back to a provisional application. Indeed, Apple itself fails to cite to any portion of Perski '455 that is not supported by the Perski '808 provisional.

Therefore, regardless of whether the '607 Patent was conceived between September 2003 and November 2003, Perski '455 would still be prior art under 35 U.S.C. § 102(e). As such, the ALJ declines to make any findings on Apple's date of invention arguments as it would be immaterial given the priority date for Perski '455.

(2) Perski '455 anticipates the asserted claims of the '607 Patent

PUBLIC VERSION

Motorola argues that Perski '455 discloses each and every limitation of the asserted claims of the '607 Patent. (RIB at 50-60.) Staff agrees. (SIB at 80-84.) Motorola notes that the only limitation that Apple argues is not disclosed by Perski '455 are the multitouch limitations, namely "the detection of multiple touches or near touches that occur at the same time and at distinct locations or the production of distinct signals representative of the location" of claim 1 and "the recognition of multiple touch events that occur at different locations on the touch panel at a same time at distinct points across the touch panel, the outputting of that information to a host device to form a pixilated image, or the detection and monitoring of a change in capacitive coupling associated with multiple touch events at distinct points across the touch panel" of claim 10. (RIB at 51.)

Indeed, Apple argues that Perski '455 does not disclose, enable or render obvious the multitouch limitations. (CIB at 135.) Specifically, Apple argues that Perski '455 fails to "disclose, enable or render obvious (1) the detection of 'multiple touches' or (2) 'multiple touch events' 'at a same time' that occur at distinct or different locations." (CIB at 135-136.) Apple argues that Perski '455 fails because (1) the disclosed method in Perski '455 is "too slow to detect multiple touches that occur 'at the same time'"; (2) the method has the same problems as other prior art in recognizing and distinguishing the number of touches; and (3) Perski '455 actually teaches away from the detection of multiply touches that occur at the same time. (CIB at 135-137.)

The ALJ finds that Motorola has shown by clear and convincing evidence that Perski '455 discloses detecting multiple finger touches at the same time. The evidence shows that Perski '455 expressly discloses a finger detection algorithm that is able to detect multiple finger touches at the same time:

PUBLIC VERSION

The goal of the finger detection algorithm, in this method, is to recognize all of the sensor matrix junctions that transfer signals due to external finger touch. It should be noted that this algorithm is preferably able to detect more than one finger touch at the same time.

* * *

However, this method enables the detection of multiple finger touches.

(RX-708 at 14:15-19; 14:37-38.) This algorithm or method disclosed in Perski '455 for detecting multiple touches is virtually identical to the disclosure in the '607 Patent. (RX-1885C, Wolfe Q&A 317; *compare* RX-708 at 14:20-43 to JX-002 at 13:58-61 (claim 1) ; RX-708 at 13:35-43, 14:15-19 to JX-002 at 17:22-35 and RX-708 at 10:6-15 and 10:23-49 to JX-002 at 18:11-16 and 18:24-39 (claim 10).)

Specifically, the evidence shows that Perski '455 discloses a transparent mutual capacitance sensor that is indisputably similar to that of the '607 Patent. (RX-1885C at Q&A 305; RX-708 at Fig. 2, 9:52-60; JX-002 at Fig. 9, 13:13-20.) Both Perski '455 and the '607 Patent detect multiple finger touches on this sensor using essentially the same method: providing a signal to each drive line, one line at a time, and measuring the signals that travel through the mutual capacitance onto orthogonal sense lines and when an output signal is detected at one or more of the intersections, touches are detected. (RX-708 at 14:20-43; JX-2 at 5:46-6:2.) Perski '455 discloses a method of driving each conductive line one at a time to "enable[] the detection of multiple finger touches":

The most simple and direct approach is to provide a signal to each one of the matrix lines in one of the matrix axes, one line at a time, and to read the signal in turn at each one of the matrix lines on the orthogonal axis ... If a significant output signal is detected, it means that there is a finger touching a junction. The junction that is being touched is the one connecting the conductor that is currently being energized with an input signal and the conductor at which the output signal is detected. The disadvantage of such a direct detection method is that it requires an order of $n*m$ steps, where n stands for the number of vertical lines and m for the number of horizontal lines. In fact, because it is typically necessary to repeat the procedure for the second axis so the number of steps is more typically $2*n*m$

PUBLIC VERSION

steps. However, this method enables the detection of multiple finger touches. When an output signal is detected on more than one conductor that means more than one finger touch is present. The junctions that are being touched are the ones connecting the conductor that is currently being energized and the conductors which exhibit an output signal.

(RX-708 at 14:20-43; *see also* RX-303 at 4 ¶ 2; RX-1885C, Wolfe Appx. A1 at 78, 94, and 99.)

Similarly, the '607 Patent describes the ability to detect multiple touches:

In mutual capacitance, the transparent conductive medium is patterned into a group of spatially separated lines formed on two different layers.... The driving lines are connected to a voltage source and the sensing lines are connected to capacitive sensing circuit. During operation, a current is driven through one driving line at a time, and because of capacitive coupling, the current is carried through to the sensing lines at each of the nodes (e.g., intersection points). Furthermore, the sensing circuit monitors changes in capacitance that occurs at each of the nodes. The positions where changes occur and the magnitude of those changes are used to help recognize the multiple touch events.

(JX-2 at 5:46-6:2.) Claim 1 of the '607 Patent requires the “produc[ti]on [of] distinct signals representative of a location of the touches on the plane of the touch panel for each of the multiple touches” and a transparent capacitive sensor medium “configured to detect multiple touches or near touches that occur at a same time.” This is similarly disclosed in Perski '455: “[t]he goal of the finger detection algorithm, in this method, is to recognize all of the sensor matrix junctions that transfer signals due to external finger touch. It should be noted that this algorithm is preferably able to detect more than one finger touch at the same time” (JX-2 at 21:35-41; RX-708 at 14:15-19; RX-1885C, Wolfe Q/A 317 and Appx. A1.)

As for Apple's arguments, the ALJ finds them unpersuasive. First, as to the argument that Perski '455 teaches away from multiple touches at the same time, the ALJ finds that Perski '455 does not do so. A reading of the entire sentence relied upon by Apple in context shows that Perski '455 is actually disclosing a method of detecting more than one finger touch at a time:

The goal of the finger detection algorithm, in this method, is to recognize all of the sensor matrix junctions that transfer signals due to external finger touch. It

PUBLIC VERSION

should be noted that this algorithm is preferably able to detect more than one finger touch at the same time.

(RX-708 at 14:15-19.) Apple's argument that Perski '455 suffers from the same prior art problems described in the '607 Patent also fails. Specifically, as noted by Motorola, Apple concedes that Perski '455 does, in fact, disclose multitouch detection. (Tr. at 1567:15-1568:2.)

Finally, with regard to Apple's last argument that the disclosed method in Perski '455 is "too slow to detect multiple touches that occur 'at the same time,'" the ALJ finds that this argument fails. First, Apple points to nothing in the '607 Patent that discusses the speed at which the drive lines are driven and sense lines sensed. Thus, the speed at which multiple touches are detected are irrelevant. Second, even assuming that speed does matter, the disclosure of a "faster" method in Perski '455 does not necessarily mean that the "simple and direct approach" disclosed by Perski '455 is "slow" as asserted by Apple. Rather, Perski '455 simply states that (1) there is a "faster" method; and (2) an "optimal approach is to combine the above methods, starting with the faster method and switching to the direct approach upon detection of a possible ambiguity." (RX-708 at 14:57-59.) There is nothing in Perski '455 to indicate that the method disclosed therein would not be able to detect touches "at the same time" as viewed by a user. Moreover, the way an anticipatory reference characterizes a disclosure is irrelevant so long as a limitation is, in fact, disclosed. *See Celeritas Techs., Ltd. v. Rockwell Int'l Corp.*, 150 F.3d 1354, 1361 (Fed. Cir. 1998). Indeed, "[a] reference is no less anticipatory if, after disclosing the invention, the reference then disparages it." *Id.*

Therefore, the ALJ finds that Perski '455 anticipates the asserted claims of the '607 Patent.

PUBLIC VERSION

b) SmartSkin

SmartSkin was considered by the examiner during prosecution so Motorola must meet a heightened burden of proving that SmartSkin anticipate the '607 Patent, which the ALJ finds they have failed to do. *See McGinley v. Franklin Sports, Inc.*, 262 F.3d 1339, 1353 (Fed. Cir. 2001) (“When no prior art other than that which was considered by the PTO examiner is relied on by the attacker, he has the added burden of overcoming the deference that is due to a qualified government agency presumed to have properly done its job, which includes one or more examiners who are assumed to have some expertise in interpreting the references and to be familiar from their work with the level of skill in the art and whose duty it is to issue only valid patents.”) (citing *American Hoist & Derrick Co. v. Sowa & Sons, Inc.*, 725 F.2d 1350, 1359, (Fed. Cir. 1984)); *Hewlett-Packard Co. v. Bausch & Lomb, Inc.*, 909 F. 2d 1464, 1467 (Fed. Cir. 1990) (particularly heavy burden in establishing invalidity on the same prior art that was examined in the PTO).

Motorola argues that the article *SmartSkin: An Infrastructure for Freehand Manipulation on Interactive Surfaces* (“SmartSkin”) written by Junichi Rekimoto and published in April 2002 is prior art that invalidates the '607 Patent. (RIB at 60-61.) Motorola argues that SmartSkin discloses each and every limitation of the asserted claims. (RIB at 61-74.) Staff agrees. (SIB at 85-93.)

Apple argues that SmartSkin fails to disclose the transparent limitations, the layer limitation, and the “glass member” limitation. (CIB at 128-133.)

The ALJ finds that Motorola has failed to meet its heavy burden of showing by clear and convincing evidence that SmartSkin discloses each and every limitation of the asserted claims. While an extremely close call, the ALJ finds that the disclosure of using ITO in SmartSkin is insufficient to meet the additional heavy burden of showing by clear and convincing evidence

PUBLIC VERSION

that SmartSkin discloses the use of transparent conductive lines using ITO. Motorola cites the following in SmartSkin in support of its argument that the reference discloses the use of transparent electrodes:

tapping), can be detected. However, like other vision-based systems, these systems also require the use of external cameras and lights, and thus they cannot be integrated into a single unit.

Bimanual interfaces Various types of bimanual (two-handed) interfaces (for example, see [1, 5, 17] and [4] for physiological analysis of these interfaces) have been studied. With such an interface, the user normally holds two input devices (e.g., a trackball and a mouse), and controls two positions on the screen. For example, the user of ToolClasses [1] controls the tool-palette location with his/her non-dominant hand, while the cursor position is controlled by the user's dominant hand. Some bimanual systems [5, 17] provide higher-degree-of-freedom control by using motion- or rotation-sensitive input devices. With the SmartSkin sensor, the user can also control more than two points at the same time, and the shape of the arm or hand can be used as input. This is another approach to achieving higher-degree-of-freedom manipulation.

In contrast to two-handed interfaces, interaction techniques that are based on the use of multiple fingers have not been well explored. DualTouch [12] uses a normal touch panel to detect the position of two fingers. Its resistive touch panel gives the middle position between two fingers when two positions are pressed, and assuming that the position of one finger is known (i.e., fixed to the initial position), the position of the other finger can be calculated. DualTouch can perform various interaction techniques such as "tapping and dragging", but due to this assumption of the initial position, most multiple-finger interfaces described in this paper are not possible.

CONCLUSION AND DIRECTIONS FOR FUTURE WORK

Our new sensing architecture can turn a wide variety of physical surfaces into interactive surfaces. It can track the position and shape of hands and fingers, as well as measure their distance from the surface. We have developed two working interactive surface systems based on this technology: a table and a tablet, and have studied various interaction techniques for them.

This work is still at an early stage and may develop in several directions. For example, interaction using multiple fingers and shapes is a very new area of human-computer interaction, and the interaction techniques described in this paper are just a few examples. More research is needed, in particular, focusing on careful usability evaluation.

Apart from investigating different types of interaction techniques, we are also interested in the following research directions.

Using a non-flat surface as an interaction medium. Places of interaction are not limited to a tabletop. Armrests or table edges, for example, can be good places for interaction, but have not been studied well as places for input devices. Placing SmartSkin sensors on the surface of "pet" robots, such as

Sony's AIBO, is another possibility. The robot would behave more naturally when interacting with humans. Similarly, if a game pad were "insane" of how the user grips it, the game software could infer the user's emotions from this information.

Combination with tactile feedback. Currently, a SmartSkin user can receive only visual feedback, but if SmartSkin could make the surface vibrate by using a transducer or a piezo actuator, the user could "feel" as if he/she were manipulating a real object (the combination of a touch panel and tactile feedback is also described by Fukumoto [3]).

Use of transparent interfaces. A transparent SmartSkin sensor can be obtained by using Indium-Tin Oxide (ITO) as a transparent electrode. This sensor can be mounted on the top of a flat-panel display or a large-scale projection display. The use of such a transparent sensor can be used to create a transparent interface. This possibility is investigated in the future, although the use of ITO as the substrate for the transparent and conductive electrode is not suitable for such a transparent interface.

We also want to make transparent tagged objects by combining transparent conductive materials with the use of capacitance tags as shown in Figure 14. This technology will enable creating interface systems such as "DataTiles" [18], a user can interact with the computer via the use of tagged physical objects and hand gestures.

Data communication between the sensor surface and other objects. Because the SmartSkin sensor uses a wave signal controlled by software, it is possible to encode this signal with data. For example, location information can be transmitted from a SmartSkin table, and a digital device such as a PDA or a cellular phone on the table can recognize this information and trigger various context-aware applications. The table could also encode and transmit a "secret key" to mobile devices on the table, and these devices can establish a secure network with this key.

ACKNOWLEDGEMENTS

We thank our colleagues at Sony Computer Science Laboratories for the initial exploration of ideas described in this paper. We also thank Shigeru Tajima for the valuable technical advice, Takao Ishizawa and Asako Toda for their contribution to the implementation of the prototype system. We also would like to thank Toshi Doi and Mario Tokoro for their continuing support of our research.

REFERENCES

1. Eric A. Bier, Maureen C. Stone, Ken Pier, William Huxton, and Tony DeRose. Toolglass and Magic Lenses: The see-through interface. In James T. Kajiya, ed-

The interesting but unasked question is "Is it possible to provide tactile or similar feedback to users whose hands are in the proximity of the surface, but not directly touching the surface?"

JX-367.007

(RX-367.007.) To the extent the reference itself describes that the use of ITO would be possible for "future work," such a statement indicates that it likely was not contemplated for that specific reference. In other words, if the simple disclosure of the use of ITO was sufficient, it would seem more likely that this would be entitled "alternatives" or "other embodiments" or some similar language. The description of ITO in the "Directions for Future Work" section appears to

PUBLIC VERSION

indicate that it could be used¹⁵ with the SmartSkin products, but that such use would require additional work. The uncertainty surrounding this disclosure fails to rise to the higher clear and convincing burden faced by Motorola.

Consequently, to the extent that Motorola's arguments relating to the layer limitation are based on SmartSkin's disclosure of using ITO for transparent conductive lines, the ALJ finds that SmartSkin also fails to disclose this limitation. (*See* RIB at 73.)

Therefore, based on the foregoing, the ALJ finds that Motorola has failed to show by the higher clear and convincing evidence burden that SmartSkin discloses the use of transparent conductive lines using ITO and discloses conductive lines on spatially separated layers.

3. The '430 Patent

(a) U.S. Patent No. 5,900,870 – The Malone Patent

U.S. Patent No. 5,900,870 to Malone et al. (the "Malone patent") is entitled "Object-Oriented Computer User Interface." (RX-289.) The Malone patent claims priority to an application filed on June 30, 1989, making it prior art to the '430 Patent under 35 U.S.C. § 102(e). (RX-289.) Apple does not dispute the prior art status of the Malone patent. (Tr. 1628:19-1629:4.) The Malone patent was not before the examiner during the prosecution of the '430 Patent. (Tr. 1629:13-17.)

Motorola argues that the Malone patent discloses each and every limitation of the asserted claims of the '430 Patent. (RIB at 165-174.) Staff agrees. (SIB at 122-125.)

The Malone patent describes Object Lens, which is a software system that lets a user view and work with objects of any type. (RX-289 at 4:49-64.) As the specification of the Malone patent explains:

¹⁵ As will be discussed *infra*, this disclosure in SmartSkin supports a finding that using ITO would have been obvious to one of ordinary skill in the art. (*See* Section VI.C.2.)

PUBLIC VERSION

Users of the Object Lens system can create, modify, retrieve, and display objects that represent many physically or conceptually familiar things such as messages, people, meetings, tasks, manufactured parts, and software bugs. The system provides an interface to an object-oriented database in the sense that (1) each object includes a collection of fields and field values, (2) each object type has a set of actions that can be performed upon it, and (3) the objects are arranged in a hierarchy of increasingly specialized types with each object type “inheriting” fields, actions, and other properties from its “parents.”

(*Id.* at 5:35-45.) One of the important features of Object Lens is that a user can create “agents,” which have rules that describe different properties of objects and can act on objects that match those properties, without the user needing to explicitly act on each object himself. (*Id.* at 6:57-7:7:6; *see also* Tr. 1631:24-1632:11.)

Motorola argues that in his direct witness statement, Dr. Locke demonstrated that the Malone patent discloses each limitation of claims 1, 3 and 5 of the '430 Patent and, therefore, Dr. the Malone patent anticipates all of the asserted claims of the '430 Patent. (RIB at 165 (citing RX-1874C at Q/A 160-175 & Appendix 13; *see also* Tr. 1215:22-1217:9.) Motorola argues that Dr. Balakrishnan and Apple did not dispute that the Malone patent discloses limitations (a), (b), and (c) of claim 1, as well as the additional limitations of dependent claims 3 and 5. (RIB at 165 (citing CX-568C at Q/A 91-107; CDX-8.017; Tr. 1634:8-13, 1636:10-24, 1637:20-1638:4; 1682:24-1684:9).) Motorola argues that the only limitation that Dr. Balakrishnan alleges is not disclosed by the Malone patent is “adding support for hardware and software components to the operating system” of limitation (d) of Claim 1. (CX-568C at Q/A 91-107; CDX-8.017; Tr. 1638:13-18.)

Indeed, Apple argues that the Malone patent does not disclose, enable or render obvious the “adding support for hardware and software components to the operating system” limitation. (CIB at 186-187; CRB at 74-76.) Specifically, Apple argues that “Malone did not disclose or enable the ‘adding support’ step (d).” (CIB at 186.) Apple argues that the Malone patent fails

PUBLIC VERSION

because “Malone discloses an application-level program that runs on top of an operating system (not an operating system itself, as required by the claims) that folders objects by properties, but does not add support, or anything else, to an operating system.” (CIB at 186.)

The ALJ finds that Motorola has shown by clear and convincing evidence that the Malone patent discloses “adding support for hardware and software components to the operating system.” The evidence shows that the Malone patent expressly discloses the Object Lens system that is part of the operating system to which support can be added for hardware and software components:

(i) The Malone Patent Discloses Adding Support To The Operating System

As discussed above in relation to indefiniteness, Dr. Balakrishnan identified the smart folder concept as one instance in the '430 Patent demonstrating the addition of support. As he explained, “[t]here are at least three distinct situations in the patent where support is added for components. . . . The third is for components that are on the system but must be collected and tracked, for example in smart folders. Beyond the typical *smart foldering functionality*, these components are supported throughout the system, for example by *permitting the system to provide notifications that components have been added, removed, or changed.*” (CX-201C at Q/A 100 (emphasis added).) Indeed, the smart folder concept is identified by the specification as a preferred embodiment. (JX-1 at 2:26-27; 12: 67-13:7; Fig. 9; *see also* CX-568C at Q/A 50.)

Dr. Balakrishnan also explained that “the locator framework facilitates access to components that have been updated through a notification system that also uses the system to unify knowledge about components and access to components.” (CX-568C at Q/A 52.) In fact, “[p]ublishing is a *primary way* this [adding support] is accomplished, under either [Apple’s or

PUBLIC VERSION

the Staff's] construction.” (*Id.* at Q/A 53 (emphasis added).) Indeed, in discussing the “Smart Folder” disclosure in the ’430 Patent, Dr. Balakrishnan stated that:

“[S]mart folder can utilize the fact that support has been added to the operating system to enable notification throughout the system for changes in components at the system level.” As the patent describes, the smart folder requests the locator to notify it of changes. The support that is added is in the locator framework, and this is described in more detail in the code provided in columns 9 through 12, where the locator framework is invoked to both perform property queries and to keep track of updates to components at a system level so that it can provide notifications when clients create an “interest” in components.

(CX-568C at Q/A 50.)

The Malone patent discloses the same notification and publishing functionalities, including the smart folder concept identified by Dr. Balakrishnan as examples of “adding support.” (Tr. 1217:10-1219:22.) The Object Lens system disclosed in the Malone patent utilizes “agents” to collect objects¹⁶ to put into a folder:

Folders also have a type of object that they prefer to contain; the user is asked to identify this type when a new folder is created. Finally, *folders can also have a selection rule which can be used as a kind of ‘agent on special assignment’ to collect objects to put into the folder.*

(RX-289 at 23:29-35 (emphasis added).) The “agents” employed in the Object Lens systems can perform a variety of tasks, including retrieving, classifying and deleting objects automatically:

Users of the Object Lens system can create rule-based “agents” that provide specifications for processing information automatically on behalf of their users. . . . *When an agent is triggered it applies a set of rules to a specified collection of objects. If an object satisfies the criteria specified in a rule, the rule performs some specified action. These actions can be general actions such as retrieving, classifying, mailing, and deleting objects or object-specific actions such as loading files or adding events to a calendar.*

The agents in Object Lens are “autonomous” in the sense that once they have been created, they can take actions without the explicit attention of a human user.

¹⁶ Dr. Balakrishnan admitted that the objects described in the Malone patent are software components. (Tr. 1652:16-18; 1656:11-16; 1683:25-1684:3.)

PUBLIC VERSION

(RX-289 at 6:57-7:9 (emphasis added).) Thus, through the use of agents employing automatic selection rules, the Malone patent teaches automatically collecting objects in a folder based on a particular search criterion. Indeed, Dr. Balakrishnan admitted that the Malone patent teaches the “same sort of notification” as the smart folder example of the ’430 Patent. (Tr. 1682:1-8; *see also id.* at 1644:1-9; 1684:4-9.)

The ALJ finds that the Malone patent provides numerous examples of how these automatic selection agents are employed by the Object Lens system. First, the Malone patent describes the collection of overdue tasks into an “Overdue Tasks” folder every night at midnight:

The Object Lens system uses rule-based agents to perform these automatic actions. For example, FIG. 20 shows an agent that maintains a folder of “Overdue Tasks.” Every night at midnight, this agent is automatically triggered and searches the “*All Tasks” folder, **a system-maintained folder** that contains all task objects in the local workstation. When the agent finds tasks whose due date has passed, it moves them into the Overdue Tasks folder.

(RX-289 at 18:24-31 (emphasis added).) Similarly, the Malone patent discloses an example in which a notification is provided whenever objects that support a position entered by the user are added to a folder:

The last step in our example is to add intelligent agents to help search and modify the network of nodes. For instance, FIG. 16 shows an agent like one you might use to **notify** you whenever people add arguments that support positions you have entered. **This agent is triggered automatically when new objects are added to the folder containing the discussion of interest.** FIG. 17 shows the rule this agent uses to select the arguments that support a specific person’s positions. This rule illustrates how embedded descriptions can be used to specify structural queries that depend on the link structure in the network as well as on the contents of individual nodes.

(RX-289 at 17:47-61 (emphasis added); *see also* Tr. 1217:19-1218:16.) The ALJ finds these examples to be indistinguishable from the examples that Dr. Balakrishnan set forth as “adding support.” (*See* CX-201C at Q/A 100; CX-568C at Q/A 50, 52; Tr. 1211:9-1212:22.) Like the smart folder preferred embodiment of the ’430 Patent, both examples from the Malone patent use

PUBLIC VERSION

specific search criteria to identify objects having desired attributes or characteristics and then provide automatic notifications whenever objects satisfying those criteria are added to the system. (*Compare* JX-1 at 12:67-13:7 with RX-289 at 18:24-31; 17:47-61.)

In addition to the specific smart folder embodiments, the Malone patent also includes an example of creating links to various objects as a means of providing system level notification. (Tr. 1646:12-1647:8; 1656:17-1657:20.) In this example, links between new mail objects and the New Mail folder are created whenever mail is retrieved:

In some cases, agents can take actions automatically on behalf of their users. For instance, FIG. 4 shows an example of a simple agent designed to help a user process incoming mail. When an agent is triggered, it applies a set of rules to a collection of objects in a folder. The agent in FIG. 4 is applied to objects in the New Mail folder and is triggered by the arrival of new mail. That is, when mail is retrieved to the workstation, ***the mail program automatically inserts links to the new messages into the user's New Mail folder and these New Links trigger the agent.*** In the current version of Object Lens, two other kinds of automatic triggers are available: Daily at Midnight, and On the Hour.

(RX-289 at 11:6-17 (emphasis added).) The ALJ finds that the creation of “links” between different objects is the same functionality that Dr. Balakrishnan pointed to in the Accused ’430 Products as satisfying the “adding support” limitation of element (d) of the ’430 Patent. (Tr. 481:16-482:6, 485:4-11.)

Apple argues that “Dr. Locke agreed in his witness statement, and again at the hearing, that smart foldering systems like Malone did not disclose or enable the ‘adding support’ step (d) of the claims. Dr. Locke specifically agreed that ‘***smart foldering does not even relate to, much less enable***’ step (d) of claim 1 of the ’430 Patent.” (Tr. 1210:19-24.) However, Dr. Locke explained that the opinion Apple relies on was in relation to Dr. Locke’s opinion that the “adding support” was indefinite. (Tr. 1211:9-1212:16.) Dr. Locke further explained that his invalidity opinion was premised on Dr. Balakrishnan’s infringement opinion – the one the ALJ has adopted in this investigation – to determine whether the Malone patent anticipated the claims. (*Id.*)

PUBLIC VERSION

There is nothing improper with such an approach. Apple's argument is, therefore, without merit.

Accordingly, the ALJ finds that Motorola has shown by clear and convincing evidence that the Malone patent discloses the addition of support as claimed in the '430 Patent and in light of Apple's infringement allegations. The remaining question is whether this support is added to the operating system as the claims require.

(ii) The Object Lens System Described In The Malone Patent Is Part Of The Operating System

Apple's other attempt to distinguish the to distinguish the '430 Patent from the Malone patent is the argument that the Object Lens system described by the Malone patent does not add support *to the operating system*. According to Dr. Balakrishnan, "[i]n the Malone reference, it is a separate system that doesn't involve the operating system directly[.]" (Tr. 1661:20-1663:4) and Object Lens is a self-contained program that "sits on top" of an operating system but "has nothing to do with the operating system per se." (Tr. 1673:20-1674:13.) Apple contends that according to the Malone patent, it is a program not an operating system: "Object Lens is an object oriented, event-driven program." (RX-289 at 18:32-35.) Apple asserts that the Malone patent simply describes a way for an application to filter objects like email or contacts into different folders. (CX-568C.033 at Q/A 97.)

Apple contends that the Malone patent does describe a computer "system," and it describes components that are a part of its "system," but that system (including the automatic agents that folder email) is simply a program that must run on top of an "operating system" without adding to it. Apple states that Dr. Balakrishnan explained that the mail functionality in the Malone patent is not itself a part of the operating system, but that it could make a call to the operating system. (Tr. 1646:9-1647:7.) Apple concludes that even under Motorola's theory, the

PUBLIC VERSION

Malone Object Lens system is separate from the operating system and must make calls on the operating system. (CRB at 76.)

Motorola refocuses the attention on Dr. Balakrishnan’s infringement allegations. Motorola notes that for infringement Dr. Balakrishnan testified that, in the context of the ’430 Patent, the operating system includes all software layers with the exception of applications. (CX-201C at Q/A 114; Tr. 1670:6-1671:3.) Mr. Nguyen, the named inventor offered similar testimony that “[i]n the context of the [‘430] patent, ‘operating system’ means everything from the desktop to the application layer to the kernel.” (JX-469C at 14:2-4; *see also id.* at 16:7-25.) Dr. Balakrishnan’s demonstratives illustrate that for the operating system of the Accused ’430 Products includes the Linux-based kernel, libraries and the application framework, including the Activity Manager and the Package Manager:

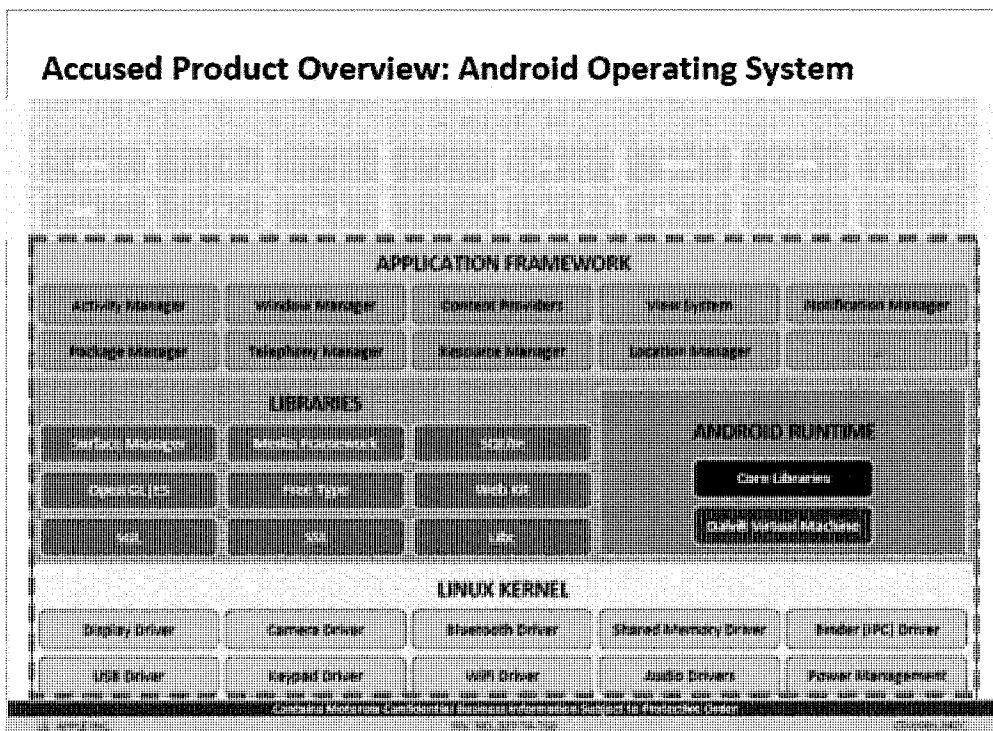

(CDX-1.042C; *see also* CX-201C at Q/A 114; Tr. 1670:6-1671:3; 1674:14-20.)

PUBLIC VERSION

The ALJ agrees with Motorola that the descriptions in the Malone patent demonstrate that Apple's argument is merely one of semantics. Based on Apple's infringement argument, the "operating system" extends up to the level where the object lens operates and far beyond the low level operations that Apple seems to contend it does for validity purposes. The ALJ finds that the evidence clearly demonstrates that the Object Lens system should be characterized as being part of the operating system. (See CX-201C at Q/A 114; Tr. 1670:6-1671:3.)

This is clearly supported by the disclosure in the Malone patent. The Malone patent begins by stating that "[t]he present invention relates to *computer systems* generally, and specifically to the portions of *computer systems* designed to display and to make available to the users the information stored therein." (RX-289 at 2:50-53 (emphasis added).) The Malone patent teaches that the capabilities described in the patent can be implemented through the use of a "general framework" and that the Object Lens system creates "a common, connected user environment [that] permits users to share information and coordinate activities more fully than with prior art systems." (RX-289 at 16:20-21; 14:27-31; see also Tr. 1248:21-1249:7.)

Moreover, in the "System Architecture" section, the Malone patent explains that "the heart of Object Lens is the Object Manager" and describes the functions performed by the Object Manager:

[T]he Object Manager is responsible for keeping track of all classes and class-instances and their links to each other. It also keeps track of the current state of each object and helps the objects handle messages which they receive by providing support functions for their methods. The Object Manager provides the Forms Manager with the information it needs to present a form. The Object Manger also handles saving and loading objects from permanent storage in the database. In the future, the Object Manager will work with a shared database to do object locking and version control.

(RX-289 at 18:66-19:9.) The System Architecture section also describes the Object Lens system's "Agent Manager," which "knows about each agent's automatic triggers. It includes

PUBLIC VERSION

processes that watch for time-based triggers and receives messages from the Object Manager about New Links and Object Updates. It also receives messages from the Object Manager about agents which have been manually triggered.” (RX-289 at 19:38-43.) The Object Manager and Agent Manager described in the Malone patent perform many of the same functionalities as the Activity Manager and Package Manger that Dr. Balakrishnan identified as being part of the operating system in the Accused ’430 Products. (Tr. 1672:16-23; 1674:21-1675:2.) Like the Activity Manager and Package Manger, the Object Manager and Agent Manager handle and perform queries for components and manage the links between various components on the system. (*Compare* RX-289 at 18:66-19:9; 19:38-43 (describing Object Lens functionality) *with* CX-201C at Q/A 126, 134 & 201 (describing functionality of Activity Manager and Package Manger).)

Moreover, the Malone patent distinguishes the Object Lens system from the “traditional model of a user environment” in which “[a]n application is launched from within an operating environment, which runs on top of the Operating System, which controls the hardware.” (RX-289 at 14:17-20.) The Object Lens system is a “new model” for computer user environments that “permits users to share information and coordinate activities more fully than with prior art systems.” (*Id.* at 14:28-31.) Object Lens achieves these added benefits by “creating a common, connected user environment” that is disclosed in figure 21C of Malone. (*Id.* at 14:27-29.) Thus, the ALJ finds the evidence shows that the type of architecture disclosed in the Malone patent is consistent with the claim language as construed by Apple and, further, with the architecture Apple now accuses of infringement.

Moreover, the ALJ notes that the specific smart folder examples contained in the Malone patent contradict Dr. Balakrishnan’s opinion that the Object Lens system is separate from the

PUBLIC VERSION

operating system described in the '430 Patent. The "Overdue Tasks" example states that the ""*All Tasks' folder [is] a *system-maintained* folder" that is then modified by Object Lens. (RX-289 at 18:27-28 (emphasis added).)

The ALJ notes that Dr. Balakrishnan's opinion regarding whether the Object Lens is part of the operating system is inconsistent because he did not contest limitation (b) requires "querying *the operating system* to identify one or more hardware components that meet the target hardware or software component search criteria." (JX-1 at 13:47-50 (emphasis added); Tr. 1634:8-13, 1636:18-1637:22.) It is also difficult to reconcile Dr. Balakrishnan's testimony at the hearing that smart folders have "nothing to do with the operating system" (Tr. 1644:1-9), with his earlier testimony regarding how the smart folder examples in the specification support the disclosure of "adding support" (See CX-201C at Q/A 100; CX-568C at Q/A 50, 52). This leads the ALJ to give less weight to his testimony because it appears to offer one opinion to defeat indefiniteness and another to fend off anticipation. This conflict undermines Dr. Balakrishnan's credibility because, unlike Dr. Locke, the ALJ has adopted his earlier claim construction and did not reject it. Having won one battle in this litigation using a particular position, Dr. Balakrishnan cannot abandon that position to win another without in some way damaging his credibility – that is, unfortunately for him, the burden of success.

Weighing all of this evidence, the ALJ finds that the Malone patent does disclose adding support to the operating system. The ALJ finds that all of the evidence clearly shows that the Object Lens in the Malone patent is properly considered part of the operating system.

The Malone patent discloses all of the limitations of claims 1, 3 and 5 of the '430 patent, including adding support to the operating system. Accordingly, all of the asserted claims are anticipated by the Malone patent.

PUBLIC VERSION

(b) UNIX *find*

UNIX *find* is a command found on the UNIX operating system that allows users to search for files based on their names and/or contents, and includes functionality for performing operations on the results of the search. (RX-1874C at Q/A 131.) Motorola argues that among the functionalities included in the UNIX *find* command is the ability to print, load and execute files returned by the *find* command without rebooting the operating system. (*Id.*) The *UNIX Primer Plus* (“Waite”) is a book by Mitchell Waite et al. that describes the UNIX *find* command. (RX-735.) Waite was published in the United States in 1990, making it prior art to the ’430 Patent under 35 U.S.C. §§ 102(a) and (b). (*Id.*) Dr. Balakrishnan conceded that the UNIX operating system and the UNIX *find* command is prior art. (Tr. 1685:12-23.)

Motorola argues that UNIX *find* discloses each and every limitation of the asserted claims of the ’430 Patent. (RIB at 174-178.) Staff agrees. (SIB at 121-122.)

Motorola argues that Dr. Locke explained why the UNIX *find* command anticipates all of the asserted claims of the ’430 Patent. (RX-1874C at Q/A 131-159 & Appendix 6; *see also* Tr. 1223:7-1224:11.) In his rebuttal witness statement, Dr. Balakrishnan disputed that the UNIX *find* command discloses any of the limitations of claim 1.¹⁷ (CX-568C at Q/A 60-90; CDX-8.014.) Motorola argues that Dr. Balakrishnan’s opinions in his witness statement directly contradict his deposition testimony. (RX-1874C at Q/A 36 (*citing* Balakrishnan Dep. Tr. at 156:21-157:11); Locke RDX-16.) Specifically, in his rebuttal witness statement, Dr. Balakrishnan took the position that the UNIX *find* command not only does not disclose “properties” but also does not disclose “returning components” under limitation (c) or “adding support” under the preamble and limitation (d). (CX-568C at Q/A 60-90; CDX-8.014.)

¹⁷ Motorola argues that Dr. Balakrishnan did not dispute that the UNIX *find* command discloses the additional limitations found in dependent claims 3 and 5. (CX-568C at Q/A 60-90.)

PUBLIC VERSION

The ALJ finds that UNIX *find* fails to anticipate the asserted claims of the '430 Patent because Motorola has failed to show by clear and convincing evidence that UNIX *find* discloses “adding support for hardware or software components to the operating system.”

Apple argues that the *find* command can perform a number of rudimentary actions on files, none of which remotely “add support” to the operating system. (CIB at 184.) Motorola argues that Dr. Locke explained in his direct witness statement that he “do[es] not indicate that merely execut[ing] a file adds support to an operating system. Waite discloses that the UNIX *find* command allows the user to apply any command to the file. . . . ***This allows literally any operating system command to have access to the identified components.***” (RIB at 177 (quoting RX-1874C at Q/A 155 (emphasis added); *see also* Tr. 1222:7-1225:13.) Motorola argues that Dr. Locke explained during the hearing that the operating system commands enabled by the *-exec* option include copying or moving the files returned as a result of a search, as well as executing any returned file that is executable. (RIB at 177 (quoting Tr. 1223:7-1224:11).) Motorola argues that when UNIX *find* causes a file or an application to execute, the UNIX system must generate pointers and other references to the executed component on the operating system. (RIB at 177 (citing Tr. 1223:24-1224:7).) Motorola argues that the UNIX *find* command also has the ability to place the files returned as a result of a search into a folder and to be incorporated into a shell script that would enable the system to periodically check for and add or remove components that meet the search criteria. (RIB at 177 (citing Tr. 1223:7-1225:13).) Apple argues that while UNIX could use the *-exec* command to “execute” a program, as Dr. Balakrishnan explained, merely executing an application in this conventional sense does not “add support” for the application to the operating system because it executes the application in

PUBLIC VERSION

memory without adding anything to the operating system that enables access to the application by other parts of the system. (CX-568C at Q/A 76.)

While the ALJ is not entirely convinced by Dr. Balakrishnan's testimony, the ALJ finds that the evidence presented by Motorola is not quite sufficient to meet the clear and convincing standard of proof. Dr. Locke's testimony by itself cannot carry the day in this case. Moreover, while the Waite reference was not itself before the examiner, UNIX is mentioned in the '430 Patent and the ALJ believes that this is an additional reason why the evidence presented here is not persuasive enough to meet the clear and convincing standard in this case. The evidence that Motorola presented does not rise to that level. Accordingly, the ALJ finds that UNIX *find* does not anticipate the asserted claims of the '430 Patent.

(c) **The Bondy Patent**

U.S. Patent No. 5,491,813 to Bondy et al. (the "Bondy patent") is entitled "Display Subsystem Architecture for Binding Device Independent Drivers Together Into a Bound Driver for Controlling a Particular Display Device." (RX-601.) The Bondy patent claims priority to an application filed on February 12, 1990. (*Id.*) The Bondy patent is therefore prior art to the '430 Patent under 35 U.S.C. § 102(e), which Apple does not dispute. The Bondy patent was not considered by the examiner during the prosecution of the '430 Patent. (JX-1.002.)

The Bondy patent describes a system to locate and dynamically bind device drivers based upon the particular graphics model being used. (RX-601 at Abstract; RX-1874C at Q/A 249.) The Bondy patent provides for a multi-step process to search for, retrieve and bind particular device drivers based upon the desired graphics model:

The programming interface of the present invention is able to reconfigure itself by dynamically binding the desired graphics package with the required RMS features and device specific model instance driver for the display adapter being used. ***This process of dynamic binding uses a database or equivalent tabular***

PUBLIC VERSION

representation to: (1) locate the specific graphics model desired; (2) retrieve this model; and (3) bind the model to the (a) device driver code for the specific display adapter being utilized, and (b) the RMS function required by the particular graphics model.

(RX-601 at 3:35-44 (emphasis added).) The searches for the desired graphics models in the system disclosed by the Bondy patent are performed based on the adapter and model IDs that are separate from the file system path:

When the API desires access to the device drivers, a general GAI RMS call is invoked, to which is provided the ID of the display adapter 1, 2, 3, or 4. The ID and other parameters from the call are used to access a look up table or configuration file and find a file system path to the required resource object file. The object file of the resource is then loaded and the entry point code is executed.

(RX-601 at 6:7-13.)

Motorola argues that the Bondy patent discloses each and every limitation of the asserted claims of the '430 Patent. (RIB at 178-182.)

Motorola argues that Dr. Locke demonstrated that the Bondy patent discloses each limitation of claims 1, 3 and 5 of the '430 Patent and, therefore, the Bondy patent anticipates all of the asserted claims of the '430 Patent. (RIB at 178 (citing RX-1874C at Q/A 249-268 & Appendix 12).) Motorola argues that Dr. Balakrishnan opined that the Bondy patent does not disclose the limitations of claim 1 except for limitation (d), "adding support."¹⁸ (CX-568C at Q/A 187-206; CDX-8.026.) However, Motorola argues that Dr. Balakrishnan's opinions that the Bondy patent does not disclose the other limitations of claim 1 are based entirely on the argument that the adapter and model IDs, by which the system in the Bondy patent searches for drivers, are intrinsic characteristics and therefore not "properties" in the context of the '430 Patent. (CX-568C at Q/A 202 (preamble); 193-194 (limitation (a)); 195-196 (limitation (b));

¹⁸ Motorola argues that Dr. Balakrishnan also did not dispute that the Bondy patent discloses the additional limitations found in dependent claims 3 and 5. (CX-568C at Q/A 187-206.)

PUBLIC VERSION

197-198 (limitation (c)). Motorola argues that the adapter and model IDs assigned to the device drivers in the Bondy patent are not intrinsic to these drivers and, therefore, are “properties” even under Dr. Balakrishnan’s definition of that term.

Indeed, Apple argues that the Bondy patent is another straightforward example of a system that relies on uniquely-identifying names rather than flexible, attached properties to match components. (CIB at 186-187; CRB at 74-76.) Specifically, Apple argues that the Bondy patent does not disclose “properties,” “querying,” or “returning.” (CRB at 78-79.) However, a review of the testimony of Dr. Balakrishnan that Apple relies on for its assertion that the Bondy patent does not meet all of these element reveals that Dr. Balakrishnan’s opinion is entirely based on the Bondy patent’s alleged failure to disclose “properties.” For example, Dr. Balakrishnan testifies that the Bondy patent does not meet the “querying” limitation because:

Bondy ’813 discloses the ‘typical look up table’ in Figure 4, which maps ‘the location and name in the file system’ for each driver to associate the right piece of code with the correct adapter and model. The conventional method of indexing resources is not remotely the same as the search method disclosed in the ’430 where a framework that can assign properties to every component is employed. (CX-568C at Q/A 197.)

The ALJ finds that Apple’s entire argument (despite its protestations) turns entirely on whether the Bondy patent discloses “properties.” Because this claim element ripples through the other claim elements, all of these elements rise or fall together on the interpretation of “properties.” (See CIB at 186 (noting the failure to disclose properties affects “querying” and “returning”).)

The ALJ finds that Motorola has shown by clear and convincing evidence that Bondy discloses “properties.” The evidence shows that the Bondy patent expressly discloses a locator system that uses properties to search for, query, and return software or hardware components:

PUBLIC VERSION

(i) The Bondy Patent Discloses “properties”

The ALJ finds that, as Dr. Locke explained in his direct witness statement, the adapter and model IDs disclosed in the Bondy patent are system assigned numbers. (RX-601 at 8:42-46, Fig. 4.) In the Bondy patent, each display adapter and graphic model is stored in resource management services (“RMS”) device driver library. (RX-601 at 3:19-23.) The RMS library utilizes a lookup table or a database to “find the path to the required model resource object file.” (RX-601 at 3:39-40, 6:25-26.) Figure 4 shows a typical lookup table:

adapter	model	object file name
1	0	/usr/lpp/gai/adapter1/rms.o
1	1	/usr/lpp/gai/adapter1/2d.o
1	2	/usr/lpp/gai/adapter1/3dm1.o
1	3	/usr/lpp/gai/adapter1/3dm2.o
2	0	/usr/lpp/gai/adapter2/rms.o
2	1	/usr/lpp/gai/adapter2/2d.o

(RX-601 at Fig. 4, 8:35-37.) As can be seen in Figure 4, the adapter and model IDs are simply numbers that are assigned by the system to a particular device driver as they are added to the lookup table. They are separate from the file path and name, which is also stored in the lookup table.

The ALJ finds that under the ALJ’s construction, which is plain and ordinary meaning, the adapter and model IDs are characteristics of the particular device driver that allow it to be identified and retrieved.

Dr. Balakrishnan argued that the adapter and model IDs are not “properties” because “[t]he properties claimed in the ‘430 patent are attributes that are attached to a component, *and describe the capabilities and contexts of the component.*” (CX-568C at Q/A 194 (emphasis

PUBLIC VERSION

added.) However, as was discussed in relation to the claim construction, there is nothing in either the '430 Patent or Apple's proposed construction that requires "properties" to describe the capabilities and context of the component. (*See supra* Section IV.E.3.)

Apple's argument boils down to the following: the Bondy patent is a "type of conventional system is very different from using a framework that can assign properties to every component and then search for items based on those properties." (CIB at 178.) Unfortunately, the claims of the '430 Patent do not mention or require the use of a "framework" or the assignment of properties. They were written extremely broadly and none of the claims, specification, or prosecution history contain any support for reading in the limitations that Apple seeks. Apple based its entire argument on post-hoc inventor testimony. Accordingly, because the ALJ finds that the Bondy patent discloses "properties" within the plain meaning of that term, the ALJ finds that Motorola has demonstrated by clear and convincing evidence that the Bondy patent anticipates the asserted claims of the '430 Patent.

C. Obviousness

Included within the presumption of validity is a presumption of non-obviousness. *Structural Rubber Prods. Co. v. Park Rubber Co.*, 749 F.2d 707, 714 (Fed. Cir. 1984).

Obviousness is grounded in 35 U.S.C. § 103, which provide, *inter alia*, that:

A patent may not be obtained though the invention is not identically disclosed or described as set forth in section 102 of this title, if the differences between the subject matter sought to be patented and the prior art are such that the subject matter as a whole would have been obvious at the time the invention was made to a person having ordinary skill in the art to which said subject matter pertains. Patentability shall not be negative by the manner in which the invention was made.

35 U.S.C. § 103(a). Under 35 U.S.C. § 103(a), a patent is valid unless "the differences between the subject matter sought to be patented and the prior art are such that the subject matter as a whole would have been obvious at the time the invention was made to a person having ordinary

PUBLIC VERSION

skill in the art to which said subject matter pertains.” 35 U.S.C. § 103(a). The ultimate question of obviousness is a question of law, but “it is well understood that there are factual issues underlying the ultimate obviousness decision.” *Richardson-Vicks Inc.*, 122 F.3d at 1479; *Wang Lab., Inc. v. Toshiba Corp.*, 993 F.2d 858, 863 (Fed. Cir. 1993).

Once claims have been properly construed, “[t]he second step in an obviousness inquiry is to determine whether the claimed invention would have been obvious as a legal matter, based on underlying factual inquiries including: (1) the scope and content of the prior art, (2) the level of ordinary skill in the art, (3) the differences between the claimed invention and the prior art; and (4) secondary considerations of non-obviousness” (also known as “objective evidence”). *Smiths Indus. Med. Sys., Inc. v. Vital Signs, Inc.*, 183 F.3d 1347, 1354 (Fed. Cir. 1999), citing *Graham v. John Deere Co.*, 383 U.S. 1, 17 (1966). The ultimate determination of whether an invention would have been obvious is a legal conclusion based on underlying findings of fact. *In re Dembiczak*, 175 F.3d 994, 998 (Fed. Cir. 1999).

Obviousness may be based on any of the alleged prior art references or a combination of the same, and what a person of ordinary skill in the art would understand based on his knowledge and said references. If all of the elements of an invention are found, then:

a proper analysis under § 103 requires, inter alia, consideration of two factors: (1) whether the prior art would have suggested to those of ordinary skill in the art that they should make the claimed composition or device, or carry out the claimed process; and (2) whether the prior art would also have revealed that in so making or carrying out, those of ordinary skill would have a reasonable expectation of success. *Both the suggestion and the reasonable expectation of success must be founded in the prior art, not in the applicant's disclosure.*

Velander v. Garner, 348 F.3d 1359, 1363 (Fed. Cir. 2003) (emphasis added) (internal citations omitted).

PUBLIC VERSION

The critical inquiry in determining the differences between the claimed invention and the prior art is whether there is a reason to combine the prior art references. *See C.R. Bard v. M3 Sys.*, 157 F.3d 1340, 1352 (Fed. Cir. 1998). For example:

[A] patent composed of several elements is not proved obvious merely by demonstrating that each of its elements was, independently, known in the prior art. Although common sense directs one to look with care at a patent application that claims as innovation the combination of two known devices according to their established functions, it can be important to identify a reason that would have prompted a person of ordinary skill in the relevant field to combine the elements in the way the claimed new invention does. This is so because inventions in most, if not all, instances rely upon building blocks long since uncovered, and claimed discoveries almost of necessity will be combinations of what, in some sense, is already known.

KSR Int'l Co. v. Teleflex, Inc., 550 U.S. 398, 418-19 (2007) (emphasis added). The Federal Circuit case law previously required that, in order to prove obviousness, the patent challenger must demonstrate, by clear and convincing evidence, that there is a “teaching, suggestion, or motivation to combine. The Supreme Court has rejected this “rigid approach” employed by the Federal Circuit in *KSR Int'l Co. v. Teleflex Inc.*, 500 U.S. 398 (2007), 127 S.Ct. 1727, 1739. The Supreme Court stated:

When a work is available in one field of endeavor, design incentives and other market forces can prompt variations of it, either in the same field or a different one. If a person of ordinary skill can implement a predictable variation, § 103 likely bars its patentability. For the same reason, if a technique has been used to improve one device, and a person of ordinary skill in the art would recognize that it would improve similar devices in the same way, using the technique is obvious unless its actual application is beyond his or her skill. *Sakraida* and *Anderson's-Black Rock* are illustrative—a court must ask whether the improvement is more than the predictable use of prior art elements according to their established function.

Following these principles may be more difficult in other cases than it is here because the claimed subject matter may involve more than the simple substitution of one known element for another or the mere application of a known technique to a piece of prior art ready for the improvement. Often, it will be necessary for a court to look to interrelated teachings of multiple patents; the effects of demands

PUBLIC VERSION

known to the design community or present in the marketplace; and the background knowledge possessed by a person having ordinary skill in the art, all in order to determine whether there was an apparent reason to combine the known elements in the fashion claimed by the patent at issue. To facilitate review, this analysis should be made explicitly. See *In re Kahn*, 441 F.3d 977, 988 (CA Fed. 2006) (“[R]ejections on obviousness grounds cannot be sustained by mere conclusory statements; instead, there must be some articulated reasoning with some rational underpinning to support the legal conclusions of obviousness”). As our precedents make clear, however, the analysis need not seek out precise teachings directed to the specific subject matter of the challenged claim, for a court can take account of the inferences and creative steps that a person of ordinary skill in the art would employ.

[...]

The obviousness analysis cannot be confined by a formalistic conception of the words teaching, suggestion, and motivation, or by overemphasis on the importance of published articles and the explicit content of issued patents. The diversity of inventive pursuits and of modern technology counsels against limiting the analysis in this way. In many fields it may be that there is little discussion of obvious techniques or combinations, and it often may be the case that market demand, rather than scientific literature, will drive design trends. Granting patent protection to advance that would occur in the ordinary course without real innovation retards progress and may, in the case of patents combining previously known elements, deprive prior inventions of their value or utility.

KSR, 550 U.S. at 417-419; 127 S.Ct. at 1740-41. The Federal Circuit has harmonized the *KSR* opinion with many prior circuit court opinions by holding that when a patent challenger contends that a patent is invalid for obviousness based on a combination of prior art references, “the burden falls on the patent challenger to show by clear and convincing evidence that a person of ordinary skill in the art would have had reason to attempt to make the composition or device, or carry out the claimed process, and would have had a reasonable expectation of success in doing so.” *PharmaStem Therapeutics, Inc. v. ViaCell, Inc.*, 491 F.3d 1342, 1360 (Fed. Cir. 2007)(citing *Medichem S.A. v. Rolabo S.L.*, 437 F.3d 1175, 1164 (Fed. Cir. 2006)); *Noelle v. Lederman*, 355 F.3d 1343, 1351-52 (Fed. Cir. 2004); *Brown & Williamson Tobacco Corp. v. Philip Morris, Inc.*, 229 F.3d 1120, 1121 (Fed. Cir. 2000) and *KSR*, 127 S.Ct. at 1740 (“a

PUBLIC VERSION

combination of elements ‘must do more than yield a predictable result’; combining elements that work together ‘in an unexpected and fruitful manner’ would not have been obvious”). Further, a suggestion to combine need not be express and may come from the prior art, as filtered through the knowledge of one skilled in the art. *See Certain Lens-Fitted Film Pkgs.*, Inv. No. 337-TA-406, Order No. 141 at 6 (May 24, 2005).

“Secondary considerations,” also referred to as “objective evidence of non-obviousness,” must be considered in evaluating the obviousness of a claimed invention, but the existence of such evidence does not control the obviousness determination. *Graham*, 383 U.S. at 17-18. A court must consider all of the evidence under the *Graham* factors before reaching a decision on obviousness. *Richardson-Vicks Inc.*, 122 F.3d at 1483-84. Objective evidence of non-obviousness may include evidence of the commercial success of the invention, long felt but unsolved needs, failure of others, copying by others, teaching away, and professional acclaim. *See Perkin-Elmer Corp. v. Computervision Corp.*, 732 F.2d 888, 894 (Fed. Cir. 1984), *cert. denied*, 469 U.S. 857 (1984); *Avia Group Int’l, Inc. v. L.A. Gear California*, 853 F.2d 1557, 1564 (Fed. Cir. 1988); *In re Hedges*, 783 F.2d 1038, 1041 (Fed. Cir. 1986); *Kloster Speedsteel AB v. Crucible Inc.*, 793 F.2d 1565 (Fed. Cir. 1986), *cert. denied*, 479 U.S. 1034 (1987). The burden of showing secondary considerations is on the patentee and, in order to accord objective evidence substantial weight, a patentee must establish a nexus between the evidence and the merits of the claimed invention; a *prima facie* case is generally set forth “when the patentee shows both that there is commercial success, and that the thing (product or method) that is commercially successful is the invention disclosed and claimed in the patent.” *In re GPAC Inc.*, 57 F.3d 1573, 1580 (Fed. Cir. 1995); *Demaco Corp. v. F. Von Langsdorff Licensing Ltd.*, 851 F.2d 1387, 1392 (Fed. Cir. 1988), *cert. denied*, 488 U.S. 956 (1988); *Certain Crystalline*

PUBLIC VERSION

Cefadroxil Monohydrate, Inv. No. 337-TA-293, Comm'n Op. (March 15, 1990). Once a patentee establishes nexus, the burden shifts back to the challenger to show that, e.g., commercial success was caused by “extraneous factors other than the patented invention, such as advertising, superior workmanship, etc.” (*Id.*) at 1393.

Generally, a prior art reference that teaches away from the claimed invention does not create *prima facie* case of obviousness. *In re Gurley*, 27 551, 553 (Fed. Cir. 1994); *see also Andersen Corp. v. Pella Corp.*, No. 2007-1536, 2008 U.S. App. LEXIS 24087, *13-18 (Fed. Cir. Nov. 19, 2008); *Certain Rubber Antidegradants*, Inv. No. 337-TA-533 (Remand), Final ID (Dec. 3, 2008) (stating, “KSR reaffirms that obviousness is negated when the prior art teaches away from the invention.”)). However, the nature of the teaching is highly relevant. *Id.* “A reference may be said to *teach away* when a person of ordinary skill, upon reading the reference, would be *discouraged from following the path set out in the reference, or would be led in a direction divergent from the path that was taken by the applicant.*” *Id.* (emphasis added). For example, “a reference will teach away if it suggests that the line of development flowing from the reference's disclosure is unlikely to be productive of the result sought by the applicant.” *Id.*

1. The '828 Patent

Motorola argues that even if the Desai Thesis or the Bisset '352 Patent are found not to anticipate the asserted claims, the claims are rendered obvious in light of the combination of Bisset and Desai. Motorola's discussion of obviousness is extremely cursory and it provides an insufficient explanation of why a person of ordinary skill in the art would be motivated to combine the Desai Thesis with Bisset. The ALJ finds that Motorola's argument appears to rest entirely on the fact that the two references are in the same field of art. (RRB at 58.) This is

PUBLIC VERSION

simply insufficient to show by clear and convincing evidence that a skilled artisan would be motivated to combine these two references to render the asserted claims obvious.

Therefore, the ALJ finds that Motorola has failed to show by clear and convincing evidence that the '828 Patent is obvious.

2. The '607 Patent

Motorola argues that SmartSkin combined with Japanese Unexamined Patent Application Publication No. 2002-342033A ("Rekimoto '033") renders the '607 Patent obvious. (RIB at 74-77.) Staff agrees. (SIB at 93-95.) Staff further argues that SmartSkin itself would make it obvious to try to use transparent electrodes. (SIB at 89.)

Apple argues that the combination of SmartSkin and Rekimoto '033 does not render the asserted claims of the '607 Patent obvious because Motorola only cites to Figure 9 of Rekimoto '033 and this combination is contrary to Motorola's own expert's opinion. Apple further argues that the transparent limitations are not disclosed by the combination for the same reasons set forth *supra* in Section VI.B.2 (anticipation). As for the layer and glass limitation, Apple argues that the combination fails to disclose these limitations because (1) the sensor in Rekimoto '033 is not the same as the sensor in SmartSkin; (2) the motivation to combine is improper hindsight bias; and (3) Rekimoto '033 discloses only a single glass substrate and not the second and third glass member. (CIB at 144-146.)

As an initial matter, the ALJ finds that SmartSkin alone would render the use of transparent electrodes obvious. Specifically, while the ALJ found that SmartSkin did not sufficiently disclose using transparent electrodes to render the asserted claims of the '607 Patent invalid under anticipation, the ALJ finds that SmartSkin does meet the standard for obviousness for the use of transparent electrodes. The prior art reference *itself* discloses using transparent

PUBLIC VERSION

electrodes – thus, any motivation to use transparent electrodes is found within the reference itself. (See *supra* Section VI.B.2.) *SIBIA Neurosciences, Inc. v. Cadus Pharm. Corp.*, 225 F.3d 1349, 1356 (Fed. Cir. 2000) (“In appropriate circumstances, a single prior art reference can render a claim obvious. However, there must be a showing of a suggestion or motivation to modify the teachings of that reference to the claimed invention in order to support the obviousness conclusion. This suggestion or motivation may be derived from the prior art reference itself, from the knowledge of one of ordinary skill in the art, or from the nature of the problem to be solved.”) (citations omitted). [REDACTED]

[REDACTED]

[REDACTED]

[REDACTED]

[REDACTED] The evidence shows that using ITO was well known at the time. (JX-367.007; CX-205C at Q&A 30.) Thus, the evidence shows that SmartSkin would motivate one of ordinary skill in the art to use transparent electrodes and that the use of materials, such as ITO, in creating the transparent electrodes was well known at the time. Therefore, the use of transparent electrodes would have been obvious to one of ordinary skill in the art.

The ALJ further finds that SmartSkin, in combination with Rekimoto ‘033, renders the asserted claims of the ‘607 Patent obvious. As noted *supra* in Section VI.B.2, Apple argued that SmartSkin failed to disclose the use of transparent electrodes, the layer limitations and the glass member limitation. As will be set forth *infra*, the ALJ finds that SmartSkin, in combination with Rekimoto ‘033, discloses these remaining, disputed limitations.

PUBLIC VERSION

Rekimoto '033 is a Japanese patent application from inventor Junichi Rekimoto, who authored the SmartSkin publication. (RX-1888 at 2; JX-367.001.) Rekimoto '033 and SmartSkin also stem from the same institution namely Sony Corporation, and in particular Sony Computer Science Laboratories, Inc.. (RX-1888 at 2; JX-367.001.) Rekimoto '033 was filed May 21, 2001 and published November 29, 2002—within months of the publication of the SmartSkin reference. (RX-1888 at 2; JX-367.001.)

The evidence shows that a person of ordinary skill in the art would be able and motivated to combine the teaching of Rekimoto '033 regarding layers, glass, and transparent electrodes placed over an LCD display with SmartSkin for at least the reasons discussed above. Among other similarities, SmartSkin and Rekimoto '033 describe a multitouch, mutual capacitance, row and column sensor from the same inventor, made for the same employer, published in the same year, using the same detection circuitry. (RX-1885C, Q&A 321; 326; 337; Tr. 1521:17-1523:1.)

Rekimoto '033 discloses a method of recognizing multiple touching or approaching objects, such as fingers, and the shape of these objects using a mutual capacitance sensor comprising drive lines and sense lines on separate layers, which is the same subject matter disclosed in the SmartSkin publication. (RX-1888 at ¶ 74; JX-367.001; *see generally* RX-1885C, Wolfe Q/A 321; 326; 337.) The touch-sensing devices illustrated in Rekimoto '033 and SmartSkin are virtually identical:

PUBLIC VERSION

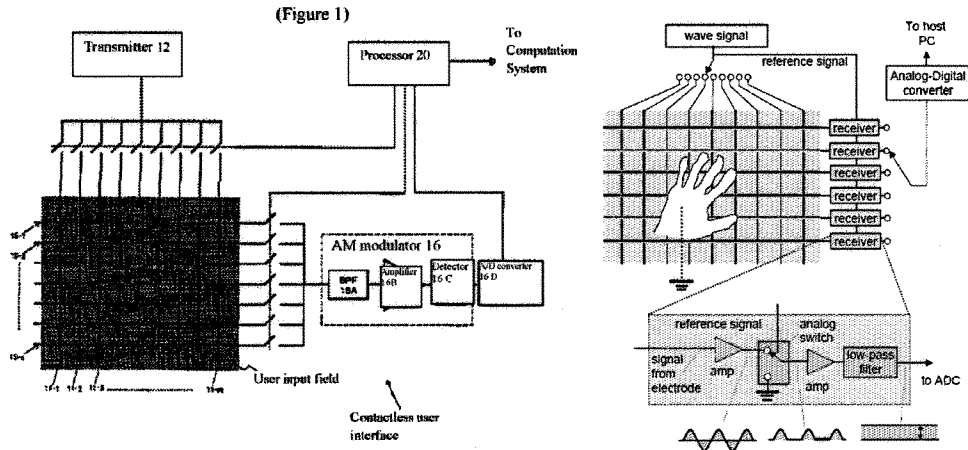

(RX-1888 at Fig. 1; JX-367 at Fig. 2; RX-1885C at Q&A 321; 326; 337; Tr. at 1311:3-1324:23; 1522:14-1523:1.) Rekimoto '033 further explains that “a contactless user interface can be constituted with a liquid crystal display, electromagnetic LED, etc., in this invention.” (RX-1888 at ¶ 24.) The touch sensor in Rekimoto '033 could “be applied in combination with other devices. For example, a user input device with a built-in display could be made by combining a flat-screen display such as a liquid crystal display or organic EL with the non-contact user input device 1.” (RX-1888 at ¶ 62.) Furthermore, Figure 9 of Rekimoto '033 shows how the touch sensor can be formed from row and column conductors on separate layers, separated by an insulator,¹⁹ placed on a glass substrate, over an electromagnetic display.

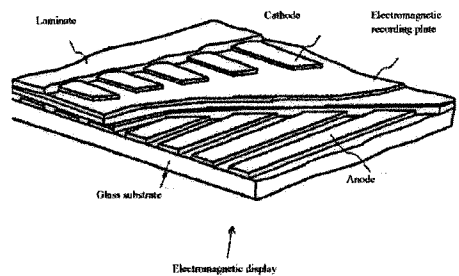

¹⁹ Figure 9 of Motorola's certified translation of Rekimoto '033 appears to contain a mistranslation: "electronic recording plate" should be "insulating layer." The body of Rekimoto '033 describes Figure 9 as follows: In the example shown in the diagram, the anode electrode layer and cathode electrode layer made of conductive polymer are laminated across an insulating layer made of organic material. (RX-1888 at ¶ 64.)

PUBLIC VERSION

(RX-1888 at Figure 9.) Thus, SmartSkin, in combination with Rekimoto '033, makes the layer limitations obvious. (RX-1888.)

As for the “glass member” limitation, the evidence shows that SmartSkin alone, and in combination with Rekimoto'033, disclose layers that are made of glass or plastic. SmartSkin describes printed circuit board electrodes on plastic, with a separate plastic cover sheet. (JX-367.004 and Fig. 9.) Rekimoto '033 discloses the use of glass substrates for the layers. (RX-1888 at Figure 9.)

Therefore, the ALJ finds that the evidence clearly and convincingly shows that the '607 Patent is obvious in light of SmartSkin in combination with Rekimoto '033.

a) Objective Indicia of Nonobviousness

As indicated above, one of the *Graham* factors that must be considered in an obviousness analysis, is “objective evidence of nonobviousness,” also called “secondary considerations.” *See Stratoflex, Inc. v. Aeroquip Corp.*, 713 F.2d 1530, 1536 (Fed. Cir. 1983) (“Thus evidence arising out of the so-called ‘secondary considerations’ must always when present be considered en route to a determination of obviousness.”). However, secondary considerations, such as commercial success, will not always dislodge a determination of obviousness based on analysis of the prior art. *See KSR Int'l*, 127 S.Ct. at 1745 (commercial success did not alter conclusion of obviousness).

Apple argues that the commercial success of the iPhone 4 and previous generations of iPhone devices, the iPad and iPod touch in the face of industry skepticism; the significant praise of the iPhone and its multi-touch touchscreen; and attempts to copy the iPhone4 rebuts any allegations of obviousness. (CIB at 147-152.) However, the ALJ finds that, even with the iPhone 4's commercial success, these secondary considerations cannot overcome the strong

PUBLIC VERSION

showing of obviousness in this instance. *Perfect Web Techs., Inc. v. InfoUSA, Inc.*, 587 F.3d 1324, 1333 (Fed. Cir. 2009) (“Moreover, as we have often held, evidence of secondary considerations does not always overcome a strong prima facie showing of obviousness.”); *Sundance, Inc. v. Demonte Fabricating Ltd.*, 550 F.3d 1356, 1368 (Fed. Cir. 2008) (“Secondary considerations of nonobviousness--considered here by the district court--simply cannot overcome this strong prima facie case of obviousness.”) (citing *Agrizap, Inc. v. Woodstream Corp.*, 520 F.3d 1337, 1344 (Fed. Cir. 2008)); *see also Dystar Textilfarben GMBH & Co. Deutschland KG v. C.H. Patrick Co.*, 464 F.3d 1356, 1371 (Fed. Cir. 2006) (“The presence of certain secondary considerations of nonobviousness are insufficient as a matter of law to overcome our conclusion that the evidence only supports a legal conclusion that claim 1 would have been obvious.”). As set forth *supra*, the claimed invention of the ’607 Patent would have been obvious to one of ordinary skill in the art, especially in light of the disclosures in SmartSkin and the related Japanese Application Rekimoto ‘033. [REDACTED]

[REDACTED]

Furthermore, the evidence shows that the iPhone’s success stems from other product characteristics such as its slim profile, light weight, good battery life, attractive design, easy to use software, and availability of numerous popular applications, songs and videos. (RX-1885C at Q&A 343-347.) Thus, the required nexus between the commercial success of the iPhone 4 and the specific features covered by the ’607 Patent does not exist.

Therefore, the ALJ finds that Apple has failed to overcome the strong showing of obviousness.

PUBLIC VERSION

3. The '430 Patent

Motorola offers only conclusory assertions that the Malone patent, UNIX *find* and the Bondy patent render the asserted claims obvious. This is insufficient to meet its burden of showing obviousness by clear and convincing evidence. Accordingly, the ALJ finds that Motorola has not shown that the asserted claims are obvious.

D. Written Description

The first paragraph of 35 U.S.C. § 112 requires:

The specification ***shall contain a written description of the invention***, and of the manner and process of making and using it, in such full, clear, concise, and exact terms as to enable any person skilled in the art ... to make and use the same ...

(emphasis added.)

The Federal Circuit has interpreted 35 U.S.C. § 112, ¶ 1, to require the patent specification to “describe the claimed invention so that one skilled in the art can recognize what is claimed.” *Enzo Biochem, Inc. v. Gen-Probe Inc.*, 323 F.3d 956, 968 (Fed. Cir. 2002). In evaluating whether a patentee has fulfilled this requirement, the standard is that the patent’s “disclosure must allow one skilled in the art ‘to visualize or recognize the identity of’ the subject matter purportedly described.” *Id.* (quoting *Regents of Univ. of Cal. v. Eli Lilly & Co.*, 119 F.3d 1559, 1573 (Fed. Cir. 1997)); *see also Cordis Corp. v. Medtronic Ave, Inc.*, 339 F.3d 1352, 1364 (Fed. Cir. 2003).

Terms need not be used *in haec verba*. *Eiselstein v. Frank*, 52 F.3d 1035, 1038 (Fed. Cir. 1995). The written description requirement can be satisfied by “words, structures, *figures*, *diagrams*, formulas, etc.” *Lockwood v. Am. Airlines, Inc.*, 107 F.3d 1565, 1572 (Fed. Cir. 1997) (emphasis added).

PUBLIC VERSION

Motorola argues that under Apple's proposed construction of properties that the asserted claims of the '430 Patent are invalid for failure to provide an adequate written description. However, the ALJ rejected Apple's construction. Accordingly, the argument is moot.

E. Enablement

Section 112, ¶ 1 of Title 35 requires that the specification describe the manner and process of making and using the invention "in such full, clear, concise, and exact terms as to enable any person skilled in the art to which it pertains, or with which it is most nearly connected, to make and use the same."

The issue of whether a disclosure is enabling is a matter of law. *Applied Materials, Inc. v. Advanced Semiconductor Materials America, Inc.*, 98 F.3d 1563, 1575 (Fed. Cir. 1996). "To be enabling, the specification of a patent must teach those skilled in the art how to make and use the full scope of the claimed invention without 'undue experimentation.'" *Genentech, Inc. v. Novo Nordisk, A/S*, 108 F.3d 1361, 1365 (Fed. Cir. 1997). "Patent protection is granted in return for an enabling disclosure of an invention, not for vague, intimations of general ideas that may or may not be workable." *Id.* at 1366. Although a specification need not disclose minor details that are well known in the art, "[i]t is the specification, not the knowledge of one skilled in the art, that must supply the novel aspects of an invention in order to constitute adequate enablement," and in so doing the specification cannot merely provide "only a starting point, a direction for further research." *Id.* On the other hand, "[i]t is not fatal if some experimentation is needed, for the patent document is not intended to be a production specification." *Northern Telecom, Inc. v. Datapoint Corp.*, 908 F.2d 931, 941 (Fed. Cir. 1990). "Undue experimentation" is "a matter of degree" and "not merely quantitative, since a considerable amount of experimentation is permissible, if it is merely routine, or if the specification in question provides a reasonable

PUBLIC VERSION

amount of guidance with respect to the direction in which the experimentation should proceed” *PPG Industries, Inc. v. Guardian Industries Corp.*, 75 F.3d 1558, 1564 (Fed. Cir. 1996).

It is well-settled that in order to be enabling under Section 112, “the patent must contain a description sufficient to enable one skilled in the art to make and use the full scope of the claimed invention.” *United States v. Teletronics, Inc.*, 857 F.2d 778, 785 (Fed. Cir. 1988); *see also Amgen, Inc. v. Chugai Pharmaceutical Co., Ltd.*, 927 F.2d 1200, 1213 (Fed. Cir. 1991) (inventor’s disclosure must be “sufficient to enable one skilled in the art to carry out the invention commensurate with the scope of his claims”). Section 112 requires that the scope of the claims must bear a reasonable correlation to the scope of enablement provided by the specification to such persons. *Application of Fischer*, 427 F.2d 833, 839 (C.C.P.A. 1970).

Motorola argues that under Apple’s proposed construction of properties that the asserted claims of the ’430 Patent are invalid for failure to provide an adequate enabling disclosure. However, the ALJ rejected Apple’s construction. Accordingly, the argument is moot.

F. Best Mode²⁰

Section 112, ¶ 1 of Title 35 of the United States Code sets out the best mode requirement, stating in relevant part that “[t]he specification shall contain . . . and shall set forth the best mode contemplated by the inventor of carrying out the invention.” 35 U.S.C. § 112 ¶ 1. The Court of Appeals for the Federal Circuit has held that “[t]he purpose of the best mode requirement is to ensure that the public, in exchange for the rights given the inventor under the patent laws, obtains

²⁰ The ALJ notes that the Leahy-Smith American Invents Act, which was enacted on September 16, 2011, removes best mode as an affirmative defense to patent infringement. However, this provision only applies to proceedings commenced on or after its enactment, thus best mode is still available an affirmative defense in this investigation. See Leahy-Smith America Invents Act, Pub. L. No. 112-29, § 15(a)(3)(A) (2011) (explaining that the failure to disclose the best mode “shall not be a basis on which any claim of a patent may be canceled or held invalid or otherwise unenforceable”).

PUBLIC VERSION

from the inventor a full disclosure of the preferred embodiment of the invention.” *Dana Corp. v. IPC Ltd. Partnership*, 860 F.2d 415, 418 (Fed. Cir. 1988), *cert. denied*, 490 U.S. 1067 (1989). The determination of whether the best mode requirement is satisfied is a question of fact, which must be proven by clear and convincing evidence. *Transco Products Inc. v. Performance Contracting, Inc.*, 38 F.3d 551, 559-60 (Fed. Cir. 1994).

In determining compliance with the best mode requirement, two inquiries are undertaken. The first inquiry is whether, at the time of filing the patent application, the inventor possessed a best mode of practicing the invention. *Eli Lilly and Co. v. Barr Laboratories, Inc.*, 251 F.3d 955, 963 (Fed. Cir. 2001); *see also Liquid Dynamics Corp. v. Vaughan Co., Inc.*, 449 F.3d 1209, 1223 (Fed.Cir. 2006); *Spectra-Physics, Inc. v. Coherent, Inc.*, 827 F.2d 1524, 1535 (Fed. Cir. 1987) (The specificity of disclosure necessary to meet the best mode requirement is determined “by the knowledge of facts within the possession of the inventor at the time of filing of the application.”). This first inquiry is subjective and focuses on the inventor’s state of mind at the time the patent application was filed. *Eli Lilly*, 251 F.3d at 963. The second inquiry is, if the inventor did possess the best mode, whether the inventor’s disclosure is adequate to enable one of ordinary skill in the art to practice the best mode of the invention. *Id.* This second inquiry is objective and depends on the scope of the claimed invention and the level of skill in the relevant art. *Id.*

The “contours of the best mode requirement are defined by the scope of the “claimed invention” and thus, the first task in any best mode analysis is to define the invention. *Northern Telecom Ltd. v. Samsung Electronics Co., Ltd.*, 215 F.3d 1281, 1286-87 (Fed. Cir. 2000). “The definition of the invention, like the interpretation of the patent claims, is a legal exercise, wherein the ordinary principles of claim construction apply.” *Id.* Once the invention is defined, the best mode inquiry moves to determining whether a best mode of carrying out that invention was held

PUBLIC VERSION

by the inventor. If so, that best mode must be disclosed. In *Pfizer, Inc. v. Teva Pharmaceuticals USA, Inc.*, 518 F.3d 1353 (Fed. Cir. 2008), the Federal Circuit summarized its best mode jurisprudence as follows:

We held that the best mode requirement does demand disclosure of an inventor’s preferred embodiment of the claimed invention. However, it is not limited to that. We have recognized that best mode requires inventors to disclose aspects of making or using the claimed invention [when] the undisclosed matter materially affects the properties of the claimed invention.

Pfizer, 518 F.3d at 1364 (internal quotations and citations omitted).

[REDACTED]

PUBLIC VERSION

[REDACTED]

[REDACTED]

[REDACTED]

[REDACTED]

[REDACTED]

[REDACTED]

[REDACTED]

[REDACTED]

[REDACTED]

[REDACTED]

[REDACTED]

[REDACTED]

[REDACTED]

[REDACTED]

[REDACTED]

[REDACTED]

[REDACTED]

[REDACTED] Apple argues that regardless, the '430 Patent's disclosure is sufficient to practice the invention. (CIB at 188 (citing JX-1 at 6:25-47, 8:45-12:13).) Apple further argues that the '430 Patent incorporates by reference Application No. 08/071,812, which issued as U.S. Patent No. 5,544,302. (CIB at 188.) Apple argues that patent, titled "Object-Oriented Framework for Creating and Using Container Objects with Built-In Properties," describes in detail the state of the Taligent desktop system. (CIB at 188.)

The Staff largely concurs with Apple's assessment of the record and argues that, under any claim construction, Motorola has not shown by clear and convincing evidence that Mr. Nguyen failed to disclose his best mode of practicing the invention under 35 U.S.C. § 112, ¶1 by failing to disclose the Taligent operating system. (SIB at 126-127.)

PUBLIC VERSION

The ALJ finds that Motorola has failed to prove by clear and convincing evidence that the '430 Patent is invalid for failure to disclose the best mode. Motorola has failed to identify any evidence or testimony that establishes clearly and convincingly that Mr. Nguyen subjectively believed his invention was “best” practiced on an undisclosed Taligent system. This failure is fatal to its best mode defense. *Eli Lilly*, 251 F.3d at 963. Therefore, the ALJ finds that Motorola has failed to show by clear and convincing evidence that the '430 Patent is invalid for failure to disclose best mode.

G. Indefiniteness

As set forth *supra* in Section IV.E.6, the ALJ found that the claim term “adding support for the hardware and software components to the operating system without rebooting the operating system” was not indefinite. (*See supra* Section IV.E.6.)

VII. Standing and Licensing**A. Standing**

Motorola argues that Apple lacks standing to assert the patents at issue because Apple is not the owner of the '430 Patent and does not have exclusive rights to that patent. (RIB at 184.) Taligent, the original assignee of the '430 Patent, was a joint venture formed by Apple and IBM in 1991. (RIB at 185.) Taligent (according to Motorola) allegedly assigned its patents, including the '430 Patent, to Object Technology Licensing Corporation (“OTLC”). (RIB at 185.) An assignment between Taligent and OTLC was executed on April 3, 1996 and recorded in the U.S.P.T.O. on April 11, 1996. (RIB at 185.) [REDACTED]

[REDACTED] Motorola argues that Apple has failed to demonstrate that it owns the patents in suit by failing to present any evidence that the assignments were properly approved by a supermajority vote of Taligent’s board of directors as required by

PUBLIC VERSION

Taligent's Amended and Restated Certificate of Incorporation. (RIB at 185.) Staff agrees with Apple that Motorola has failed to present sufficient evidence to show that the assignments are invalid.

Standing to sue is a threshold requirement in every federal action. *Sicom Systems, Ltd. v. Agilent Technologies, Inc.*, 427 F.3d 971, 975-76 (Fed. Cir. 2005). The party bringing the action bears the burden of establishing that it has standing. (*Id.*); see also *Ortho Pharm. Corp. v. Genetics Instit., Inc.*, 52 F.3d 1026, 1033 (Fed. Cir. 1995) (quoting *Whitmore v. Arkansas*, 495 U.S. 149, 154 (1990)) ("It is well established ... that before a federal court can consider the merits of a legal claim, the person seeking to invoke the jurisdiction of the court must establish the requisite standing to sue."). Thus, as complainant, Apple bears the burden of proof that it has standing to pursue its infringement action against Motorola in this investigation. While the burden of persuasion remains at all times with Apple, once Apple has satisfied its initial burden of production showing that it is the owner of the asserted patents, the burden of production shifts to Motorola to rebut such a showing.

There is a presumption in patent law that an inventor owns his invention. *Israel Bio-Eng'g Project v. Amgen, Inc.*, 475 F.3d 1256, 1263 (Fed. Cir. 2007). Consistent with that presumption, the "[p]atent issuance creates a presumption that the named inventors are the true and only inventors." *Id.* (quoting *Ethicon, Inc. v. U.S. Surgical Corp.*, 135 F.3d 1456, 1460 (Fed. Cir. 1998)). The named inventor of the '430 Patent is Frank T. Nguyen, and as such, it is presumed that Nguyen is the true and only inventor of the '430 Patent. (See JX-1.) According to the undisputed record evidence, Nguyen assigned his rights in the '430 Patent to Taligent. (JX-489 at 5.) On April 11, 1996, an assignment dated April 3, 1996, purporting to assign the '430 Patent (among others) was recorded with the U.S.P.T.O (Reel 7886 Frame 500). (JX-8.) The

PUBLIC VERSION

recording of an assignment, such as the April 3, 1996 assignment, “creates a presumption of validity as to the assignment and places the burden to rebut such a showing on one challenging the assignment.” *SiRF Tech., Inc. v. Int’l Trade Comm’n*, 601 F.3d 1319, 1328 (Fed. Cir. 2010). On December 10, 2009, OTLC executed an assignment, which was recorded with the U.S.P.T.O (Reel 23810 Frame 315) assigning the ’430 Patent (among others) to Apple.

The ALJ finds that Apple has sufficiently established through a chain of recorded assignments that it is the presumptive owner of the ’430 Patent. *See SiRF Tech.*, 601 F.3d at 1328. The ALJ also finds that the evidence Motorola offers to rebut that presumption is insufficient. The mere fact that directors cannot remember specific votes on minor issues from 15 years ago or that 15 year old records of defunct corporation cannot be located are insufficient to rebut the presumption in this case. Accordingly, the ALJ finds that at the very least, based on the April 3, 1996 assignment, Apple has standing to sue.

B. Licensing

A license under a patent, whether express or implied, is generally a complete defense to a charge of infringement, as long as the patent or invention is used in accordance with the license agreement.” *Certain Flash Memory Controllers, Drivers, Memory Cards, and Media Players and Products Containing Same*, Inv. No. 337-TA-619, Initial Determination at 37 (April 10, 2009) (unreviewed in relevant part) (citing *Glass Equip. Dev., Inc. v. Besten, Inc.*, 174 F.3d 1337 (Fed. Cir. 1999)). Although a defendant has the burden to prove the affirmative license defense, it must only establish such a defense by a preponderance of the evidence. *Certain Lens-Fitted Film Packages*, Inv. No. 337-TA-406, Comm’n Op. at 4 (June 1999) (citing *Technical Develop Corp. v. United States*, 597 F.2d 733, 746 (Ct. Cl. 1979)).

PUBLIC VERSION

1. [REDACTED] License

On [REDACTED] entered into a patent cross-license agreement (“the [REDACTED] Cross-License”). (RX-994C.) In this agreement, [REDACTED] granted to [REDACTED], on behalf of itself and its subsidiaries, the right to practice the [REDACTED] [REDACTED] (RX-994C at MOTO-APPLE-005632061_00008.) The [REDACTED] Cross-License defines Licensed Patents as “all patents . . . issued or issuing on patent applications entitled to an effective filing date prior to [REDACTED], under which patents or the applications therefor [REDACTED] or any of its Subsidiaries now has, or hereafter obtains, the right to grant licenses to [REDACTED]” (*Id.* at MOTO-APPLE-005632061_00003.) The [REDACTED] Cross-License defines [REDACTED] [REDACTED] [REDACTED] (*Id.* at MOTO-APPLE-005632061_00007-8.)

2. History of Taligent Ownership

Taligent was a joint venture formed by IBM and Apple in 1991 for the purpose of developing an object-oriented operating system. (JX-545C.) [REDACTED] [REDACTED] [REDACTED] [REDACTED] [REDACTED] [REDACTED] [REDACTED]

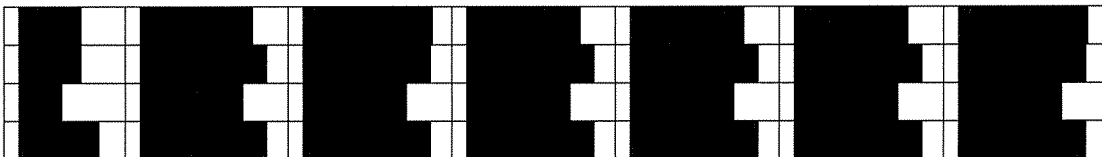

[REDACTED]

PUBLIC VERSION

[REDACTED]

3. The Assignment Of Taligent’s Patents To OTLC

On April 3, 1996, Taligent purported to assign its patent portfolio to OTLC. That assignment expressly provided that it was “subject to all licenses previously granted by Assignor.” (JX-489.022-23.) On April 11, 1996, the April 3, 1996 assignment was recorded in the Patent Office. (*Id.* at 1.) When that assignment was recorded, OTLC’s attorney represented to the Patent Office that the assignment from Taligent to OTLC was executed on April 3, 1996, that the document intended to accomplish an assignment and that “to the best of [his] knowledge and belief, the foregoing information is true and correct and any attached copy is a true copy of the original document.” (JX-489.006-7.)

4. Arguments

[REDACTED]

PUBLIC VERSION

[REDACTED]

PUBLIC VERSION

[REDACTED]

The parties do not discuss what law should apply to determine whether the transfer took place on [REDACTED] or on April 3, 1996. Apple appears to suggest California law applies. (CRB at 84-85.) As this investigation is governed by federal law, federal choice of law rules apply. *Wordtech Sys., Inc. v. Integrated Networks Solutions, Inc.*, 609 F.3d 1308, 1318 n.4 (Fed. Cir. 2010); *see also TianRui Group Co. v. U.S. Int'l Trade Comm'n*, 661 F.3d 1322, 1326-27 (Fed. Cir. 2011) (applying single federal standard for trade secret violations in Section 337 violations). Under federal choice of law provisions, the determination of which particular state's law should apply "requires the exercise of an informed judgment in the balancing of all the interests of the states with the most significant contacts in order best to accommodate the equities among the parties to the policies of those states." *Vanston Bondholders Protective Committee v. Green*, 329 U.S. 156, 162 (1946). While the assignment is between two Delaware corporations,

PUBLIC VERSION

the ALJ finds that the state with the greatest interest is California. California was site of the contract, the place where Taligent was based, and where the work that led to the intellectual property was performed. As such, the ALJ finds California law should apply.

[REDACTED]

“When a contract is reduced to writing, the intention of the parties is to be ascertained from the writing alone, if possible....” Cal. Civ. Code § 1639. “In the construction of a statute or instrument, the office of the Judge is simply to ascertain and declare what is in terms or in substance contained therein, not to insert what has been omitted, or to omit what has been inserted....” Cal. Code Civ. Proc., § 1858. However, “[a] contract must be interpreted so as to give effect to the mutual intention of the parties, and the whole of a contract is to be taken together, so as to give effect to every part, if reasonably practicable, each clause helping to interpret the other.” *El Dora Oil Co. v. Gibson*, 256 P. 550 (Cal. 1927). Under California law:

The test of admissibility of extrinsic evidence to explain the meaning of a written instrument is not whether it appears to the court to be plain and unambiguous on its face, but whether the offered evidence is relevant to prove a meaning to which the language of the instrument is reasonably susceptible. To determine whether offered evidence is relevant to prove such a meaning the court must consider all credible evidence offered to prove the intention of the parties. If the court decides, after considering this evidence, that the language of a contract, in the light of all the circumstances, is fairly susceptible of either one of the two interpretations contended for . . . , extrinsic evidence to prove either of such meanings is admissible.

Delta Dynamics, Inc. v. Arioto, 446 P.2d 785, 787 (Cal. 1968) (Traynor, C.J.) (citations and quotation marks omitted). Also, under California law, “[w]here there is an inconsistency

PUBLIC VERSION

between two agreements both of which are executed by all of the parties, the later contract supersedes the former.” *Frangipani v. Boecker*, 75 Cal. Rptr. 2d 407, 409 (Cal. App. 4th Dist. 1998).

This is a closer case than it should be, but the ALJ finds that Motorola has failed to prove that it is licensed under the [REDACTED]. [REDACTED]

[REDACTED]

[REDACTED]

[REDACTED]

[REDACTED]

[REDACTED]

[REDACTED]

[REDACTED]

[REDACTED]

[REDACTED]

[REDACTED]

[REDACTED]

[REDACTED]

[REDACTED]

[REDACTED]

[REDACTED]

[REDACTED]

[REDACTED]

[REDACTED]

PUBLIC VERSION

[REDACTED]

[REDACTED]

Setting this evidence aside because of its infirmities, the ALJ finds firmer ground in the overall structure of the agreements and the testimony of Apple's corporate representative persuasive on this point. [REDACTED]

[REDACTED]

[REDACTED]

[REDACTED]

[REDACTED] The ALJ finds that his evidence is relevant and that it is consistent with a reasonable interpretation of the agreements at issue in this case. *See Delta Dynamics*, 446 P.2d at 787. Accordingly, the ALJ interprets the assignments as transferring of the patents [REDACTED] before Taligent became a subsidiary of IBM. Therefore, Motorola's licensing defense fails.

VIII. DOMESTIC INDUSTRY

A. Applicable Law

As stated in the notice of investigation, a determination must be made as to whether an industry in the United States exists as required by subsection (a)(2) of section 337. Section 337 declares unlawful the importation, the sale for importation or the sale in the United States after importation of articles that infringe a valid and enforceable U.S. patent only if an industry in the United States, relating to articles protected by the patent . . . concerned, exists or is in the process of being established. There is no requirement that the domestic industry be based on the same claim or claims alleged to be infringed. 19 U.S.C. § 1337(a)(2).

PUBLIC VERSION

The domestic industry requirement consists of both an economic prong (*i.e.*, there must be an industry in the United States) and a technical prong (*i.e.*, that industry must relate to articles protected by the patent at issue). *See Certain Ammonium Octamolybdate Isomers*, Inv. No. 337-TA-477, Comm'n Op. at 55, USITC Pub. 3668 (January 2004). The complainant bears the burden of proving the existence of a domestic industry. *Certain Methods of Making Carbonated Candy Products*, Inv. No. 337-TA-292, Comm'n Op. at 34-35, USITC Pub. 2390 (June 1991).

Thus, in this investigation Apple must show that it satisfies both the technical and economic prongs of the domestic industry requirement with respect to the '828, the '607 and the '430 Patents. As noted, and as explained below, it is found that these domestic industry requirements have been satisfied for all three patents.

A complainant in a patent-based Section 337 investigation must demonstrate that it is practicing or exploiting the patents at issue. *See* 19 U.S.C. § 1337(a)(2) and (3); *also see Certain Microsphere Adhesives, Process for Making Same, and Products Containing Same, Including Self-Stick Repositionable Notes*, Inv. No. 337-TA-366, Comm'n Op. at 8 (U.S.I.T.C., January 16, 1996) ("*Certain Microsphere Adhesives*"), *aff'd sub nom. Minn. Mining & Mfg. Co. v. U.S. Int'l Trade Comm'n*, 91 F.3d 171 (Fed. Cir. 1996) (Table); *Certain Encapsulated Circuits*, Comm'n Op. at 16. The complainant, however, is not required to show that it practices any of the claims asserted to be infringed, as long as it can establish that it practices at least one claim of the asserted patent. *Certain Point of Sale Terminals and Components Thereof*, Inv. No. 337-TA-524, Order No. 40 (April 11, 2005). Fulfillment of this so-called "technical prong" of the domestic industry requirement is not determined by a rigid formula, but rather by the articles of commerce and the realities of the marketplace. *Certain Diltiazem Hydrochloride and Diltiazem*

PUBLIC VERSION

Preparations, Inv. No. 337-TA-349, U.S.I.T.C. Pub. No. 2902, Initial Determination at 138, (U.S.I.T.C., February 1, 1995) (unreviewed in relevant part) (“*Certain Diltiazem*”); *Certain Double-Sided Floppy Disk Drives and Components Thereof*, Inv. No. 337-TA-215, 227 U.S.P.Q. 982, 989 (Comm’n Op. 1985) (“*Certain Floppy Disk Drives*”).

The test for claim coverage for the purposes of the technical prong of the domestic industry requirement is the same as that for infringement. *Certain Doxorubicin and Preparations Containing Same*, Inv. No. 337-TA-300, Initial Determination at 109 (U.S.I.T.C., May 21, 1990) (“*Certain Doxorubicin*”), *aff’d*, Views of the Commission at 22 (October 31, 1990). “First, the claims of the patent are construed. Second, the complainant’s article or process is examined to determine whether it falls within the scope of the claims.” (*Id.*) As with infringement, the first step of claim construction is a question of law, whereas the second step of comparing the article to the claims is a factual determination. *Markman*, 52 F.3d at 976. The technical prong of the domestic industry can be satisfied either literally or under the doctrine of equivalents. *Certain Excimer Laser Systems for Vision Correction Surgery and Components Thereof and Methods for Performing Such Surgery*, Inv. No. 337-TA-419, Order No. 43 (July 30, 1999). The patentee must establish by a preponderance of the evidence that the domestic product practices one or more claims of the patent. *See Bayer*, 212 F.3d at 1247.

The economic prong of the domestic industry requirement is defined in subsection 337(a)(3) as follows:

(3) For purposes of paragraph (2), an industry in the United States shall be considered to exist if there is in the United States, with respect to the articles protected by the patent, copyright, trademark or mask work concerned –

- (A) Significant investment in plant and equipment;
- (B) Significant employment of labor or capital; or
- (C) Substantial investment in its exploitation, including engineering, research and development, or licensing.

PUBLIC VERSION

19 U.S.C. § 1337(a)(3).

The economic prong of the domestic industry requirement is satisfied by meeting the criteria of any one of the three factors listed above.

Section 337(a)(3)(C) provides for domestic industry based on “substantial investment” in the enumerated activities, including licensing of a patent. *See Certain Digital Processors and Digital Processing Systems, Components Thereof, and Products Containing Same*, Inv. No. 337-TA-559, Initial Determination at 88 (May 11, 2007) (“*Certain Digital Processors*”). Mere ownership of the patent is insufficient to satisfy the domestic industry requirement. *Certain Digital Processors* at 93. (citing the Senate and House Reports on the Omnibus Trade and Competitiveness Act of 1988, S.Rep. No. 71). However, entities that are actively engaged in licensing their patents in the United States can meet the domestic industry requirement. *Certain Digital Processors* at 93. In establishing a domestic industry under Section 337(a)(3)(C), the complainant does not need to show that it or one of its licensees is practicing a patent-in-suit. *See Certain Semiconductor Chips with Minimized Chip Package Size and Products Containing Same*, Inv. No. 337-TA-432, Order No. 13, at 11, (January 24, 2001) (“*Certain Semiconductor Chips*”). The complainant must, however, receive revenue, *e.g.* royalty payments, from its licensing activities. *Certain Digital Processors*, at 93-95 (“Commission decisions also reflect the fact that a complainant’s receipt of royalties is an important factor in determining whether the domestic industry requirement is satisfied . . . [t]here is no Commission precedent for the establishment of a domestic industry based on licensing in which a complainant did not receive any revenue from alleged licensing activities. In fact, in previous investigations in which a complainant successfully relied solely on licensing activities to satisfy section 337(a)(3), the complainant had licenses yielding royalty payments.”) (citations omitted). *See also Certain*

PUBLIC VERSION

Video Graphics Display Controllers and Products Containing Same, Inv. No. 337-TA-412, Initial Determination at 13 (May 14, 1999) (“*Certain Video Graphics Display Controllers*”); *Certain Integrated Circuit Telecommunication Chips and Products Containing Same Including Dialing Apparatus*, Inv. No. 337-TA-337, U.S.I.T.C. Pub. No. 2670, Initial Determination at 98 (March 3, 1993) (“*Certain Integrated Circuit Telecommunication Chips*”); *Certain Zero-Mercury-Added Alkaline Batteries, Parts Thereof and Products Containing Same*, Inv. No. 337-TA-493, Initial Determination at 142 (June 2, 2004) (“*Certain Zero-Mercury-Added Alkaline Batteries*”); *Certain Semiconductor Chips*, Order No. 13 at 6 (January 24, 2001); *Certain Digital Satellite System DSS Receivers and Components Thereof*, Inv. No. 337-TA-392, Initial and Recommended Determinations at 11 (December 4, 1997) (“*Certain Digital Satellite System DSS Receivers*”).

B. Technical Prong

Apple has met to meet the technical prong of the domestic industry requirement. Apple relies on the iPhone and Mac OS X to establish the technical prong of domestic industry. (CIB at 78).

1. The ‘828 Patent

Apple argues that the iPhone 4 meets all of the limitations of claim 10 of the ‘828 Patent.

(CIB at 74-76.) [REDACTED]

PUBLIC VERSION

[REDACTED]

Therefore, the ALJ finds that Apple has shown by a preponderance of the evidence that the iPhone 4 practices claim 10 of the '828 Patent.

2. The '607 Patent

Apple argues that it iPhone 4 meets all the limitations claims 1-7 and 10 either literally or under the doctrine of equivalents. To the extent that Apple need only show that the iPhone4 practices one claim of the '607 Patent, the ALJ finds that Apple has shown by a preponderance of the evidence that the iPhone 4 practices claim 1. (*See Bayer*, 212 F.3d at 1247 (the patentee must establish by a preponderance of the evidence that the domestic product practices one or more claims of the patent).) The ALJ's decision not to address the other claim limitations set forth by Apple does not indicate that it has not been considered. Rather, in light of the foregoing, such analyses have been deemed superfluous and immaterial.

Staff argues that Apple has shown by a preponderance of the evidence that the iPhone 4 practices claim 1 of the '607 Patent. (SIB at 79-80.)

[REDACTED]

PUBLIC VERSION

[REDACTED]

a) Preamble – “A touch panel comprising a transparent capacitive sensing medium configured to detect multiple touches or near touches that occur at a same time and at distinct locations in a plane of the touch panel and to produce distinct signals representative of a location of the touches on the plane of the touch panel for each of the multiple touches, wherein the transparent capacitive sensing medium”

Apple argues that the iPhone 4 satisfied the preamble because it contains a transparent touch panel that is capable of accurately recognizing multiple, simultaneous touches or near touches. (CIB at 94.) Staff agrees. (SIB at 79-80.) Motorola does not dispute that the iPhone 4 meets this limitation. (RIB at 39-47; RRB at 18-26.)

[REDACTED]

Therefore, the ALJ finds that the iPhone 4 meets this limitation.

b) “first layer having a plurality of transparent first conductive lines that are electrically isolated from one another” and “second layer spatially separated from the first layer and having a plurality of transparent second conductive lines that are electrically isolated from one another”

[REDACTED]

PUBLIC VERSION

[REDACTED]

Therefore, the ALJ finds that the iPhone 4 meets this limitation.

c) “second conductive lines being positioned transverse to the first conductive lines, the intersection of transverse lines being positioned at different locations in the plane of the touch panel”

[REDACTED]

[REDACTED] Motorola does not dispute that the iPhone 4 meets this limitation.

(RIB at 39-47; RRB at 18-26.)

d) “each of the second conductive lines being operatively coupled to capacitive monitoring circuitry”

[REDACTED]

PUBLIC VERSION

[REDACTED]

Therefore, the ALJ finds that the iPhone 4 meets this claim limitation.

e) “wherein the capacitive monitoring circuitry is configured to detect changes in charge coupling between the first conductive lines and the second conductive lines”

[REDACTED]

[REDACTED]

[REDACTED]

[REDACTED]

[REDACTED]

[REDACTED]

Therefore, the ALJ finds that the iPhone 4 meets this claim limitation.

Based on the foregoing, the ALJ finds that Apple has shown by a preponderance of the evidence that the iPhone 4 practices claim 1 of the ‘607 Patent.

3. The ‘430 Patent

Apple argues that its Mac OS X, through the I/O Kit, practices the ‘430 Patent. (CIB at 177-181.) Staff agrees that Apple meets the technical prong of the domestic industry requirement. Motorola only disputes whether Mac OS X meets Apple’s construction of “properties.” (RIB at 162-165.) As set forth *supra*, the ALJ rejected Apple’s construction. Apple performed an element by element analysis of the iPhone 4 in its initial post hearing brief. (CIB at 177-181.) Given that there is no longer any genuine dispute regarding the iPhone 4 and having reviewed the evidence cited in Apple’s initial post-hearing brief, the ALJ finds that Apple has met the technical prong of the domestic industry requirement for the ‘430 Patent. (See CX-206C; CX-201C at Q&A 235-314.)

PUBLIC VERSION

C. Economic Prong

On September 15, 2011, the ALJ issued an Initial Determination finding that Apple had satisfied the economic prong of domestic industry requirement. *See* Order No. 14 (September 15, 2011). On October 14, 2011, the Commission determined not to review the order. *See Notice of Commission Decision Not To Review an Initial Determination Granting Complainant's Motion for Summary Determination on the Economic Prong of the Domestic Industry Requirement* (October 14, 2011).

Having made the foregoing findings on whether the domestic industry requirement has been met, the ALJ finds that the disposition of this material issue satisfies Commission Rule 210.42(d). The ALJ's failure to discuss any matter raised by the parties, or any portion of the record, does not indicate that it has not been considered. Rather, any such matter(s) or portion(s) of the record has/have been deemed immaterial.

PUBLIC VERSION

IX. CONCLUSIONS OF LAW

1. The Commission has personal jurisdiction over the parties, and subject-matter jurisdiction over the accused products.
2. The importation or sale requirement of section 337 is satisfied.
3. The accused products literally infringe the asserted claims of the '430 Patent and the '607 Patent.
4. The accused products do not literally infringe the asserted claims of the '828 Patent.
5. The accused products do not infringe the asserted claims of any of the asserted patents under the doctrine of equivalents
6. The asserted claims of the '430 Patent and the '607 Patent are invalid under 35 U.S.C. § 102 for anticipation.
7. The asserted claims of the '607 Patent are invalid under 35 U.S.C. § 103 for obviousness.
8. The asserted claims of the '430 Patent are not invalid for failing to meet the written description, enablement, indefiniteness or best mode requirement.
9. Apple has standing to assert the '430 Patent.
10. Motorola is not licensed to practice the '430 Patent.
11. The technical prong of the domestic industry requirement for all of the asserted patents has been satisfied.
12. It has not been established that a violation exists of section 337.

PUBLIC VERSION

X. INITIAL DETERMINATION AND ORDER

Based on the foregoing, it is the INITIAL DETERMINATION (“ID”) of this ALJ that no violation of section 337 of the Tariff Act of 1930, as amended, has occurred in the importation into the United States, the sale for importation, or the sale within the United States after importation of certain mobile devices and related software that infringe one or more of claims 1, 2, 10, 11, 24-26, and 29 U.S. Patent No. 7,812,828; claims 1-7 and 10 of U.S. Patent No. 7,663,607; and claims 1, 3, and 5 of the U.S. Patent No. 5,379,430.

Further, this Initial Determination, together with the record of the hearing in this investigation consisting of:

- (1) the transcript of the hearing, with appropriate corrections as may hereafter be ordered, and
- (2) the exhibits received into evidence in this investigation, as listed in the attached exhibit lists in Appendix A,

are CERTIFIED to the Commission. In accordance with 19 C.F.R. § 210.39(c), all material found to be confidential by the undersigned under 19 C.F.R. § 210.5 is to be given *in camera* treatment.

The Secretary shall serve a public version of this ID upon all parties of record and the confidential version upon counsel who are signatories to the Protective Order (Order No. 1.) issued in this investigation, and upon the Commission investigative attorney.

PUBLIC VERSION

RECOMMENDED DETERMINATION ON REMEDY AND BOND**I. Remedy and Bonding**

The Commission's Rules provide that subsequent to an initial determination on the question of violation of section 337 of the Tariff Act of 1930, as amended, 19 U.S.C. § 1337, the administrative law judge shall issue a recommended determination containing findings of fact and recommendations concerning: (1) the appropriate remedy in the event that the Commission finds a violation of section 337, and (2) the amount of bond to be posted by respondents during Presidential review of Commission action under section 337(j). *See* 19 C.F.R. § 210.42(a)(1)(ii).

A. Limited Exclusion Order

Under Section 337(d), the Commission may issue either a limited or a general exclusion order. A limited exclusion order directed to respondents' infringing products is among the remedies that the Commission may impose, as is a general exclusion order that would apply to all infringing products, regardless of their manufacturer. *See* 19 U.S.C. § 1337(d).

Apple requests that a limited exclusion order be issued that prohibits the importation of all infringing products. (CIB at 193.) Motorola requests that any limited exclusion order be "narrowly-tailored to the smallest Motorola component part or parts that include only the element found by the Commission to infringe valid claims of the Asserted Patents." (RIB at 195.) Motorola argues that such an order would "provide Apple with sufficient relief and avoid improperly restricting legitimate commerce harming United States consumers." (RIB at 195.) Motorola further argues that the limited exclusion order should "except from its scope all activities related to and component parts utilized in the 'service and repair' of previously-sold accused products." (RIB at 195.) Motorola also argues that the limited exclusion order should

PUBLIC VERSION

except from its scope “any merchandise delivered pursuant to preexisting contracts,” because otherwise consumers will be adversely affected. (RIB at 195-96.) Finally, Motorola argues that any limited exclusion order should “include a certification provision such that Motorola can certify to United States Customs that its products do not infringe the asserted claims of the Asserted Patents.” Motorola argues that such a certification provision would “assist Customs if Motorola later enters into a license agreement with Apple because it will enable Customs to determine which Motorola products are no longer subject to exclusion.” (RIB at 196.)

Staff agrees that a limited exclusion order is appropriate. (SIB at 134-35.) It does not agree with most of Motorola’s limitations with the exception of the certification provision. (CIB at 135.) Staff argues that this Investigation is not directed solely to components of the accused devices. (SIB at 135.) The Staff argues that the “narrowly-tailored” exclusion order the Motorola seeks “would not give Apple the relief it seeks. . . .” Therefore, Staff argues that any limited exclusion order should be directed toward all the accused devices that are found to infringe. (SIB at 135.) However, Staff does agree with Motorola that a certification provision, as Motorola proposes, is routinely included in exclusion order and would be appropriate in this investigation.

Apple responds that Motorola’s arguments are primarily premised on the so-called “public interest factors” and are not properly considered by the ALJ. (CRB at 87.) As for Motorola’s argument that the exclusion order should be limited to the smallest possible component, Apple argues that the complaint in the investigation is directed at the entire mobile handset – not some component of one. (CRB at 87-88.) As for Motorola’s proposed service exemption, Apple argues that Motorola fails to show how such an exemption would serve the

PUBLIC VERSION

public interest and fails to point to supporting evidence in the record. (CRB at 89.) Apple also argues that such an exception would render the exclusion order meaningless. (CRB at 89.)

The ALJ finds that the appropriate remedy is a limited exclusion order directed at the Accused Products that have been found to infringe the Asserted Claims of the Asserted Patents with a certification provision where Motorola can certify to the United States Customs that its products do not infringe the asserted claims of the asserted patents. The ALJ agrees with Apple and Staff that the limited exclusion order should not be limited to the smallest component as Motorola contends because this Investigation is directed at the entire mobile device and not its components. Furthermore, such a narrow exclusion order would not give Apple any effective relief.

As for Motorola's service and repair and existing contracts exceptions, they appear to be premised on public interest considerations that are more appropriately directed to the Commission. *See* 19 C.F.R. § 210.50(b)(1) (“[A]n administrative law judge shall not address the issue of the public interest. . . .”). The ALJ agrees with Motorola and Staff that a certification provision where Motorola can certify to the United States Customs that its products do not infringe the asserted claims of the asserted patents is appropriate.

B. Cease and Desist Order

Section 337 provides that in addition to, or in lieu of, the issuance of an exclusion order, the Commission may issue a cease and desist order as a remedy for violation of section 337. *See* 19 U.S.C. § 1337(f)(1). The Commission generally issues a cease and desist order directed to a domestic respondent when there is a “commercially significant” amount of infringing, imported product in the United States that could be sold so as to undercut the remedy provided by an exclusion order. *See Certain Crystalline Cefadroxil Monohydrate*, Inv. No. 337-TA-293, USITC

PUBLIC VERSION

Pub. 2391, Comm'n Op. on Remedy, the Public Interest and Bonding at 37-42 (June 1991); *Certain Condensers, Parts Thereof and Products Containing Same, Including Air Conditioners for Automobiles*, Inv. No. 337-TA-334, Comm'n Op. at 26-28 (Aug. 27, 1997).

Apple argues that there is evidence of commercially significant inventories of infringing articles. (CIB at 194.) Motorola argues that is not entitled to a cease and desist order because Apple has failed to introduce evidence of current inventories. (RIB at 196-97.) The Staff agrees with Apple and argues that the evidence Apple offered shows that there are commercially significant inventories.

The ALJ finds the evidence shows that Motorola maintains a commercially significant inventory of accused products. (CX-203C at Q107-09; CX-32C at 38-40.) Therefore, the ALJ recommends that the Commission issue a cease and desist order against Motorola because of its commercially significant inventories of accused products.

C. Bond During Presidential Review Period

The Administrative Law Judge and the Commission must determine the amount of bond to be required of a respondent, pursuant to section 337(j)(3), during the 60-day Presidential review period following the issuance of permanent relief, in the event that the Commission determines to issue a remedy. The purpose of the bond is to protect the complainant from any injury. 19 C.F.R. § 210.42(a)(1)(ii), § 210.50(a)(3).

When reliable price information is available, the Commission has often set the bond by eliminating the differential between the domestic product and the imported, infringing product. *See Certain Microsphere Adhesives, Processes for Making Same, and Products Containing Same, Including Self-Stick Repositionable Notes*, Inv. No. 337-TA-366, Comm'n Op. a 24 (1995). In other cases, the Commission has turned to alternative approaches, especially when the level of a

PUBLIC VERSION

reasonable royalty rate could be ascertained. See, e.g., *Certain Integrated Circuit Telecommunication Chips and Products Containing Same, Including Dialing Apparatus*, Inv. No. 337-TA-337, Comm'n Op. at 41 (1995). A 100 percent bond has been required when no effective alternative existed. See, e.g., *Certain Flash Memory Circuits and Products Containing Same*, Inv. No. 337-TA-382, USITC Pub. No. 3046, Comm'n Op. at 26-27 (July 1997) (a 100% bond imposed when price comparison was not practical because the parties sold products at different levels of commerce, and the proposed royalty rate appeared to be *de minimis* and without adequate support in the record).

Apple argues for a 100% bond on all of the products or in the alternative several different bonds depending on the particular combination of patents that is infringed. In its alternative scenario, if all three patents or if just the '430 Patent are infringed, Apple argues that a 100% bond is appropriate. However, if infringement is limited to either the '828 or '607 Patents, or both, then a price differential bond of approximately [REDACTED] is appropriate. (CIB at 194-97.)

Motorola argues that Apple has failed to meet its burden of proof as to the amount of the bond, and therefore, no bond should be required. In the alternative, Motorola argues that a 100% bond is inappropriate. Respondents argue that the royalty rate should be between [REDACTED] and [REDACTED] (RIB at 197-200.) Staff argues that for simplicity the bond should be set at 100%.

The ALJ finds that a price differential bond of no more than [REDACTED] for the '828 and '607 Patent would more than adequately protect Apple during the Presidential bond period. (RX-1876C at Q&A 124.) Accordingly, for the '828 and '607 Patents, the ALJ recommends that the Commission set the bond at no more than [REDACTED] per entered product.

As for the '430 Patent, it is undisputed that Motorola does not compete directly with Apple's Mac OS X operating system and computers running it. (CIB at 194-97.) It is also

PUBLIC VERSION

undisputed that [REDACTED] represents the average royalty in the industry. (RIB at 199.) The ALJ finds that such a royalty would provide adequate compensation to Apple for this patent. Accordingly, with The ALJ recommends that the Commission set a bond of no more than [REDACTED] for the '430 Patent.

II. Conclusion

In accordance with the discussion of the issues contained herein, it is the RECOMMENDED DETERMINATION ("RD") of the ALJ should the Commission find a violation, then it should issue a limited exclusion order directed at Motorola's products found to infringe the '828 Patent, the '607 Patent, and the '430 Patent that includes a certification provision under which Motorola can certify to Customs and Border Protection that its products do not infringe the asserted claims of the Asserted Patents. The Commission should also issue a cease and desist order directed toward Motorola that prohibits the sale of any commercially significant quantities of the Accused Products. Furthermore, Motorola should be required to post a bond set at no more than [REDACTED] of the entered value of the accused products for the '430 Patent and of no more than [REDACTED] for the '828 and '607 Patents during the Presidential review period.

Within seven days of the date of this document, each party shall submit to the office of the Administrative Law Judge a statement as to whether or not it seeks to have any portion of this document deleted from the public version. The parties' submissions must be made by hard copy by the aforementioned date.

Any party seeking to have any portion of this document deleted from the public version thereof must submit to this office (1) a copy of this document with red brackets indicating any portion asserted to contain confidential business information by the aforementioned date and (2)

PUBLIC VERSION

a list specifying where said redactions are located. The parties' submission concerning the public version of this document need not be filed with the Commission Secretary.

SO ORDERED.



Theodore R. Essex
Administrative Law Judge

**IN THE MATTER OF CERTAIN MOBILE DEVICES,
AND RELATED SOFTWARE THEREOF**

Inv. No. 337-TA-750

PUBLIC CERTIFICATE OF SERVICE

I, James R. Holbein, hereby certify that the attached **INITIAL DETERMINATION** has been served by hand upon, the Commission Investigative Attorney, **Lisa A. Kattan, Esq.** and the following parties as indicated on **January 25, 2012**.

James R. Holbein, Secretary
U.S. International Trade Commission
500 E Street, SW, Room 112A
Washington, D.C. 20436

ON BEHALF OF COMPLAINANT APPLE INC.:

Mark G. Davis, Esq. () Via Hand Delivery
WEIL, GOTSHALL & MANGES LLP () Via Overnight Mail
1300 Eye Street, NW, Suite 900 () Via First Class Mail
Washington, DC 20005 () Other: _____

ON BEHALF OF RESPONDENT MOTOROLA MOBILITY, INC.:

Charles F. Schill, Esq. () Via Hand Delivery
STEPTOE & JOHNSON LLP () Via Overnight Mail
1330 Connecticut Avenue, NW () Via First Class Mail
Washington, DC 20036 () Other: _____

PUBLIC MAILING LIST:

Heather Hall () Via Hand Delivery
LEXIS - NEXIS () Via Overnight Mail
9443 Springboro Pike () Via First Class Mail
Miamisburg, OH 45342 () Other: _____

Kenneth Clair () Via Hand Delivery
THOMSON WEST () Via Overnight Mail
1100 Thirteenth Street, NW, Suite 200 () Via First Class Mail
Washington, D.C. 20005 () Other: _____

Notice of Commission Decision To
Review in Part and on Review To
Affirm a Final Determination
Finding No Violation of Section 337;
Termination of Investigation,
Dated March 16, 2012

UNITED STATES INTERNATIONAL TRADE COMMISSION
Washington, D.C.

In the Matter of

CERTAIN MOBILE DEVICES, AND
RELATED SOFTWARE THEREOF

Inv. No. 337-TA-750

NOTICE OF COMMISSION DECISION TO REVIEW IN PART AND ON REVIEW TO
AFFIRM A FINAL DETERMINATION FINDING NO VIOLATION OF SECTION 337;
TERMINATION OF INVESTIGATION

AGENCY: U.S. International Trade Commission.

ACTION: Notice.

SUMMARY: Notice is hereby given that the U.S. International Trade Commission has determined to review in part the presiding administrative law judge's ("ALJ") final initial determination ("ID") issued on January 13, 2012, finding no violation of section 337 of the Tariff Act of 1930, 19 U.S.C. § 1337 in the above-captioned investigation, and on review, to affirm the ID's finding of no violation. The investigation is hereby terminated.

FOR FURTHER INFORMATION CONTACT: Megan M. Valentine, Office of the General Counsel, U.S. International Trade Commission, 500 E Street, S.W., Washington, D.C. 20436, telephone (202) 708-2301. Copies of non-confidential documents filed in connection with this investigation are or will be available for inspection during official business hours (8:45 a.m. to 5:15 p.m.) in the Office of the Secretary, U.S. International Trade Commission, 500 E Street, S.W., Washington, D.C. 20436, telephone (202) 205-2000. General information concerning the Commission may also be obtained by accessing its Internet server at <http://www.usitc.gov>. The public record for this investigation may be viewed on the Commission's electronic docket (EDIS) at <http://edis.usitc.gov>. Hearing-impaired persons are advised that information on this matter can be obtained by contacting the Commission's TDD terminal on (202) 205-1810.

SUPPLEMENTARY INFORMATION: The Commission instituted this investigation on November 30, 2010, based on a complaint filed by Apple Inc., f/k/a Apple Computer, Inc., of Cupertino, California. 75 *Fed. Reg.* 74081-82. The complaint alleges violations of section 337 of the Tariff Act of 1930, as amended, 19 U.S.C. § 1337, in the importation into the United States, the sale for importation, and the sale within the United States after importation of certain mobile devices and related software by reason of infringement of certain claims of U.S. Patent Nos. 7,812,828 ("the '828 Patent"); 7,663,607 ("the '607 Patent"); and 5,379,430 ("the '430 Patent"). The Commission's notice of investigation named Motorola, Inc. n/k/a Motorola Solutions of Schaumburg, Illinois ("Motorola Solutions") and Motorola Mobility, Inc. ("Motorola") of

Libertyville, Illinois as respondents. The Office of Unfair Import Investigation was named as a participating party. The Commission subsequently terminated Motorola Solutions as a respondent based on withdrawal of allegations pursuant to Commission Rule 210.21(a)(1) (19 C.F.R. § 210.21(a)(1)). Notice (Aug. 31, 2011).

On January 13, 2012, the ALJ issued his final ID, finding no violation of Section 337. Specifically, the ALJ determined that accused products do not infringe the asserted claims of the '828 Patent either literally or under the doctrine of equivalents ("DOE"). The ALJ also found that the asserted claims of the '828 Patent are not invalid. The ALJ further found that the accused products literally infringe the asserted claims of the '430 and '607 patents, but do not infringe under DOE. The ALJ also found that the asserted claims of the '430 Patent are invalid under 35 U.S.C. § 102 for anticipation, and that the asserted claims of the '607 Patent are invalid under 35 U.S.C. § 102 for anticipation and under 35 U.S.C. § 103 for obviousness. The ALJ further found that Apple has standing to assert the '430 Patent, and that Motorola is not licensed to practice the '430 Patent. The ID also includes the ALJ's recommended determination on remedy and bonding in the event that the Commission reversed his finding of no violation of Section 337.

On January 30, 2012, Apple filed a petition for review of certain aspects of the ID's findings concerning claim construction infringement, and validity. Also on January 30, 2012, Motorola filed a contingent petition for review of certain aspects of the ID's findings concerning claim construction infringement, validity, domestic industry, standing, and licensing. On February 7, 2012, Motorola filed a response to Apple's petition for review. Also on February 7, 2012, Apple filed a response to Motorola's contingent petition for review. Further on February 7, 2012, the Commission investigative attorney filed a joint response to both Apple's and Motorola's petitions.

On February 22, 2012, non-party Google Inc. filed a public interest statement in response to the post-RD Commission Notice issued on January 25, 2012. *See* Corrected Notice of Request for Statements on the Public Interest (Jan. 25, 2012). On February 23, Apple filed a post-RD statement on the public interest pursuant to section 201.50(a)(4) of the Commission's Rules of Practice and Procedure (19 C.F.R. § 201.50(a)(4)), along with a motion for leave to file the statement out of time.

Having examined the record of this investigation, including the ALJ's final ID, the petitions for review, and the responses thereto, the Commission has determined to review the final ID in part.

Specifically, the Commission determines to review the ID for the limited purpose of clarifying that the ALJ also found claims 24-26, and 29 of the '828 Patent not infringed, and on review, to affirm this finding. We note that the ID does not explicitly address the issue of infringement of claims 24-26 and 29 of the '828 Patent, but finds no violation of Section 337 by reason of infringement of claims 1, 2, 10, 11, 24-26, and 29 of the '828 Patent. *See* ID at 205. We find, however, that the ALJ's analysis of the claim limitations "mathematically fitting an ellipse" and "mathematically fit an ellipse" with respect to claims 1 and 10, respectively, of the '828 Patent reflects the arguments and evidence adduced by Apple with respect to infringement of

claims 24-26 and 29. Apple presented no argument or evidence concerning infringement of the limitation “means for fitting an ellipse to at least one of the pixel groups” in claim 24 and, by dependency, claims 25-26 and 29 of the ‘828 Patent separate from its infringement arguments concerning claims 1 and 10. Accordingly, Apple has failed to meet its burden to demonstrate infringement of claims 25-26 and 29 of the ‘828 Patent.

The Commission also determines to review the ID’s finding that the asserted claims of the ‘607 Patent are obvious under 35 U.S.C. § 103 in view of the reference “SmartSkin: An Infrastructure for Freehand Manipulation on Interactive Surfaces” by Jun Rekimoto either alone or in combination with Japan Unexamined Patent Application Publication No. 2002-342033A to Jun Rekimoto, and on review, modify the ID but affirm the finding that Motorola has demonstrated by clear and convincing evidence that the asserted claims of the ‘607 Patent are invalid under 35 U.S.C. § 103. The Commission’s reasoning will be set forth in an opinion to be issued shortly.

The Commission also determines to review the ID’s finding that the accused products infringe claims 1, 3 and 5 of the ‘430 Patent, and on review, affirm the ID’s finding of direct infringement, but find that the analysis of infringement is incomplete in the ID because the ID’s analysis does not address the Commission’s decision in *Certain Electronic Devices with Image Processing Systems, Components Thereof, And Associated Software*, 337-TA-724, Comm. Op. at 10-20 (Dec. 21, 2011).

The Commission has determined not to review the remaining issues decided in the ID. Apple’s motion for leave to file its public interest comments out of time is denied as moot.

The authority for the Commission’s determination is contained in section 337 of the Tariff Act of 1930, as amended (19 U.S.C. § 1337), and in sections 210.42-46 and 210.50 of the Commission’s Rules of Practice and Procedure (19 C.F.R. § 210.42-46 and 210.50).

By order of the Commission.



James R. Holbein
Secretary to the Commission

Issued: March 16, 2012

CERTAIN MOBILE DEVICES AND RELATED SOFTWARE

Inv. No. 337-TA-750

PUBLIC CERTIFICATE OF SERVICE

I, James R. Holbein, hereby certify that the attached **NOTICE** has been served by hand upon the Commission Investigative Attorney, Lisa M. Kattan, Esq., and the following parties as indicated on **March 19, 2012**.



James R. Holbein, Secretary
U.S. International Trade Commission
500 E Street, SW, Room 112
Washington, DC 20436

On Behalf of Complainant Apple Inc.:

Mark G. Davis, Esq.
WEIL, GOTSHALL & MANGES LLP
1300 Eye Street, NW, Suite 900
Washington, DC 20005

- Via Hand Delivery
- Via Overnight Delivery
- Via First Class Mail
- Other: _____

On Behalf of Respondent Motorola Mobility, Inc.:

Charles F. Schill, Esq.
STEPTOE & JOHNSON LLP
1330 Connecticut Avenue, NW
Washington, DC 20036

- Via Hand Delivery
- Via Overnight Delivery
- Via First Class Mail
- Other: _____

Commission Opinion,
Dated March 28, 2012

MAY CONTAIN CONFIDENTIAL BUSINESS INFORMATION

**UNITED STATES INTERNATIONAL TRADE COMMISSION
Washington, D.C.**

In the Matter of

**CERTAIN MOBILE DEVICES, AND
RELATED SOFTWARE THEREOF**

Inv. No. 337-TA-750

COMMISSION OPINION

I. BACKGROUND

A. Procedural History¹

The Commission instituted this investigation on November 30, 2010, based on a complaint filed by Apple Inc., f/k/a Apple Computer, Inc., of Cupertino, California (“Apple”). 75 *Fed. Reg.* 74081-82. The complaint alleges violations of section 337 of the Tariff Act of 1930, as amended, 19 U.S.C. § 1337 (“Section 337”), in the importation into the United States, the sale for importation, and the sale within the United States after importation of certain mobile devices and related software by reason of infringement of certain claims of U.S. Patent Nos. 7,812,828; 7,663,607 (“the ‘607 Patent”); and 5,379,430 . The Commission’s notice of investigation named Motorola, Inc. n/k/a Motorola Solutions of Schaumburg, Illinois (“Motorola, Inc.”) and Motorola Mobility, Inc. of Libertyville, Illinois (“Motorola”) as respondents. The Office of Unfair Import Investigation (“IA”) was named as a participating party. On August 16, 2011, the presiding administrative law judge (“ALJ”) issued an initial determination (“ID”) granting a joint

¹ The procedural history of the investigation prior to the issuance of the final ID is fully set forth in that document. See Final ID at 1-2.

MAY CONTAIN CONFIDENTIAL BUSINESS INFORMATION

unopposed motion to terminate the investigation as to Motorola, Inc. *See* Order No. 10 (Aug. 16, 2011). The Commission determined not to review Order No. 10. *See* Notice (Aug. 31, 2011).

On January 13, 2012, the ALJ issued his final ID (“Final ID”), finding no violation of Section 337. In particular, as is relevant to this opinion, the ALJ found that the asserted claims of the ‘607 Patent are invalid for anticipation under 35 U.S.C. § 102 and invalid for obviousness under 35 U.S.C. § 103. On January 30, 2012, Apple filed a petition for review of certain aspects of the final ID. In particular, Apple requested that the Commission review the ID’s findings that the asserted claims of the ‘607 Patent are invalid.² On February 7, 2012, Motorola and the IA filed responses to Apple’s petition for review.³

On March 16, 2012, the Commission determined to review the final ID in part, and on review, to affirm the ID’s finding of no violation of Section 337 and to terminate the investigation. *See* Notice of Commission Decision to Review In Part And On Review To Affirm a Final Determination Finding No Violation of Section 337; Termination of Investigation (March 16, 2012). In particular, the Commission determined to review the ID’s finding that the asserted claims of the ‘607 Patent are obvious under 35 U.S.C. § 103 in view of the reference “SmartSkin: An Infrastructure for Freehand Manipulation on Interactive Surfaces” by Jun Rekimoto (“SmartSkin”), either alone or in combination with Japan Unexamined Patent Application Publication No. 2002-342033A to Jun Rekimoto (“Rekimoto ‘033”). As discussed below, on review, the Commission affirms the ID’s finding of obviousness in view of the SmartSkin

² Also on January 30, 2012, Motorola filed a contingent petition for review of certain aspects of the final ID.

³ The IA’s February 7, 2012, filing included her response to Motorola’s contingent petition. Apple also filed a response to Motorola’s contingent petition on February 7, 2012.

MAY CONTAIN CONFIDENTIAL BUSINESS INFORMATION

reference in combination with Rekimoto '033 and finds that Motorola has demonstrated by clear and convincing evidence that the asserted claims of the '607 Patent are invalid under 35 U.S.C. § 103 based on modified reasoning.

B. Patent at Issue

The '607 Patent is entitled "Multipoint Touchscreen" and is directed to a touch panel that has a transparent capacitive sensing medium configured to detect multiple touches or near touches that occur simultaneously and at different locations on the touch panel. In response to the multiple touches, the sensing medium produces distinct signals representative of the location of the touches. The inventors of the '607 Patent are Steve Hotelling, Joshua A. Strickon, and Brian Q. Huppi. The patent is assigned to Apple. The '607 Patent has 11 claims, of which claims 1-7 and 10 were asserted against Motorola.

Asserted claim 1 of the '607 Patent and its dependent asserted claims 2-7 are directed generally to a touch panel having a transparent capacitive sensing medium configured to detect multiple, co-occurring touches at different locations on the touch panel and to produce signals representative of the location of the touches. The touch panel comprises two layers of transparent electrically-isolated conductive lines where the two layers are spatially separated from each other and where the conductive lines in one layer are positioned transverse to the conductive lines in the other layer, creating an array of intersection points. Capacitive monitoring circuitry is configured to detect changes in the capacitance between the two layers of conductive lines, indicating the location of the multiple touches on the touch panel. Asserted claim 10 of the '607 Patent is directed generally to a display arrangement comprising a display for a graphical user interface and a transparent touch panel, which has a multipoint sensing arrangement configured

MAY CONTAIN CONFIDENTIAL BUSINESS INFORMATION

to recognize multiple, co-occurring touches at different locations on the touch panel by sensing a resulting change in capacitive coupling associated with the touches and is capable of outputting this information to a host device to form a pixilated image. The touch panel has three glass plates separating two transparent conductive layers. Each conductive layer contains a plurality of spaced parallel lines having the same pitch and linewidths, where the lines in one of the layers are perpendicular to the lines in the other layer.

II. STANDARD OF REVIEW

Once the Commission determines to review an initial determination, its review is conducted *de novo*. *Certain Polyethylene Terephthalate Yarn and Prods. Containing Same*, Inv. No. 337-TA-457, Comm'n Op. at 9 (June 18, 2002). Upon review, the "Commission has 'all the powers which it would have in making the initial determination,' except where the issues are limited on notice or by rule." *Certain Flash Memory Circuits and Prods. Containing Same*, Inv. No. 337-TA-382, USITC Pub. 3046, Comm'n Op. at 9-10 (July 1997) (quoting *Certain Acid-Washed Denim Garments and Accessories*, Inv. No. 337-TA-324, Comm'n Op. at 5 (Nov. 1992)). Commission practice in this regard is consistent with the Administrative Procedure Act. *Certain EPROM, EEPROM, Flash Memory, and Flash Microcontroller Semiconductor Devices and Prods. Containing Same*, Inv. No. 337-TA-395, Comm'n Op. at 6 (Dec. 11, 2000) ("*EPROM*"); *see also* 5 U.S.C. § 557(b).

Upon review, "the Commission may affirm, reverse, modify, set aside or remand for further proceedings, in whole or in part, the initial determination of the administrative law judge." 19 C.F.R. § 210.45(c). "The Commission also may make any findings or conclusions that in its judgment are proper based on the record in the proceeding." *Id.* This rule reflects the

MAY CONTAIN CONFIDENTIAL BUSINESS INFORMATION

fact that the Commission is not an appellate court, but is the body responsible for making the final agency decision. On appeal, only the Commission's final decision is at issue. *See EPROM* at 6 (citing *Fischer & Porter Co. v. U.S. Int'l Trade Comm'n*, 831 F.2d 1574, 1576-77 (Fed. Cir. 1987)).

III. OBVIOUSNESS OF THE '607 PATENT

Under 35 U.S.C. § 103(a), a patent is valid unless “the differences between the subject matter sought to be patented and the prior art are such that the subject matter as a whole would have been obvious at the time the invention was made to a person having ordinary skill in the art to which said subject matter pertains.” 35 U.S.C. § 103(a). The ultimate question of obviousness is a question of law, but “it is well understood that there are factual issues underlying the ultimate obviousness decision.” *Richardson-Vicks Inc. v. Upjohn Co.*, 122 F.3d 1476, 1479 (Fed. Cir. 1997).

Once claims have been properly construed, “[t]he second step in an obviousness inquiry is to determine whether the claimed invention would have been obvious as a legal matter, based on underlying factual inquiries including: (1) the scope and content of the prior art, (2) the level of ordinary skill in the art, (3) the differences between the claimed invention and the prior art; and (4) secondary considerations of non-obviousness.” *Smiths Indus. Med. Sys., Inc. v. Vital Signs, Inc.*, 183 F.3d 1347, 1354 (Fed. Cir. 1999) (citing *Graham v. John Deere Co.*, 383 U.S. 1, 17 (1966)). The Federal Circuit previously required that, in order to prove obviousness, the patent challenger must demonstrate, by clear and convincing evidence, that there is a “teaching, suggestion, or motivation to combine.” The Supreme Court, however, rejected this “rigid approach” in *KSR Int'l Co. v. Teleflex Inc.*:

MAY CONTAIN CONFIDENTIAL BUSINESS INFORMATION

The obviousness analysis cannot be confined by a formalistic conception of the words teaching, suggestion, and motivation, or by overemphasis on the importance of published articles and the explicit content of issued patents. The diversity of inventive pursuits and of modern technology counsels against limiting the analysis in this way. In many fields it may be that there is little discussion of obvious techniques or combinations, and it often may be the case that market demand, rather than scientific literature, will drive design trends. Granting patent protection to advances that would occur in the ordinary course without real innovation retards progress and may, in the case of patents combining previously known elements, deprive prior inventions of their value or utility.

550 U.S. 398, 419 (2007).

In determining that the SmartSkin reference (RX-367) does not anticipate the asserted claims of the '607 Patent, the ALJ concluded that the only limitation SmartSkin does not disclose is "the use of transparent conductive lines using [indium tin oxide] ITO." Final ID at 148. Specifically, the ALJ found that the inclusion of the discussion concerning transparent ITO electrodes in the section entitled "Conclusion and Directions for Future Work" "indicates that it likely was not contemplated for that specific reference." *Id.*; see RX-367 (SmartSkin) at 7.

Motorola argued before the ALJ that SmartSkin in combination with Rekimoto '033 renders the claim limitations concerning the use of transparent electrodes, separate layers, and the use of glass members recited in the '607 Patent obvious, while the IA additionally argued that SmartSkin alone "would make it obvious to try to use transparent electrodes." *Id.* at 172. Apple argued that SmartSkin does not disclose the transparent electrode limitations for the same reasons that the ALJ found SmartSkin does not anticipate the asserted claims of the '607 Patent. *See id.* Apple also argued that the combination of SmartSkin and Rekimoto '033 does not disclose the layer and glass limitations. *Id.* Specifically, Apple asserted that, because, Rekimoto '033 and SmartSkin disclose different sensors, there is no motivation to combine the references

MAY CONTAIN CONFIDENTIAL BUSINESS INFORMATION

without “improper hindsight bias.” *Id.* Apple further argued that “Rekimoto ‘033 discloses only a single glass substrate and not the second and third glass member” recited in the asserted claims of the ‘607 Patent. *Id.*

The ID finds that “SmartSkin alone would render the use of transparent electrodes obvious.” *Id.* In particular, the ALJ concluded that “[SmartSkin] *itself* discloses using transparent electrodes[,]” and, therefore, SmartSkin provides the motivation to do so. *Id.* at 172-173. The ALJ also found that “ITO was well known at the time.” *Id.* The ALJ, therefore, found that “SmartSkin would motivate one of ordinary skill in the art to use transparent electrodes and that the use of materials, such as ITO, in creating the transparent electrodes was well known at the time [of the invention of the ‘607 Patent]” and as such “would have been obvious to one of ordinary skill in the art.” *Id.*⁴ The ID also finds that “SmartSkin, in combination with Rekimoto ‘033, renders the asserted claims of the ‘607 Patent obvious.” *Id.* Noting Apple’s arguments concerning why SmartSkin does not anticipate the ‘607 Patent, the ALJ found that SmartSkin discloses the “glass member” limitations and that SmartSkin in combination with Rekimoto ‘033, which was published within months of the publication of the SmartSkin reference, disclose the “glass member” and “layer” limitations. *Id.* at 176 (citing JX-367 (SmartSkin) at 4 and Fig. 9; RX-1888 (Rekimoto ‘033) at Fig. 9).⁵

The Commission concurs with the ALJ’s conclusion that SmartSkin provides the reason

⁴ The ID finds that, with respect to the ‘607 Patent, one of ordinary skill in the art “would have a bachelor’s degree in electrical engineering, physics, computer engineering, or a related field and [two to three] years of work experience with input devices.” ID at 17.

⁵ The ID construes the claim limitation “glass member” to mean “a glass or plastic element.” ID at 53. The parties do not contest this construction.

MAY CONTAIN CONFIDENTIAL BUSINESS INFORMATION

to combine the use of transparent electrodes made of materials such as ITO with the mutual-capacitance sensor for detecting multiple touches on the sensor surface disclosed in SmartSkin. See RX-1885C (Wolfe Direct Witness Statement) at Q. 321. We also agree with the ALJ that SmartSkin in combination with Rekimoto '033 discloses the transparent electrode limitations, the layer limitations, and the glass member limitations recited in the asserted claims of the '607 Patent, with Rekimoto '033 disclosing the layer and glass member limitations.⁶ The Commission, however, finds that SmartSkin provides "one of ordinary skill . . . [with] a reasonable expectation of success" that the combination of transparent ITO electrodes with the mutual-capacitance touch screen disclosed in SmartSkin would be operable for different reasons than those articulated in the final ID. See *Velandar v. Garner*, 348 F.3d 1359, 1363 (Fed. Cir. 2003).⁷

The claim limitations in dispute, which are referred to as the "transparent limitations," are highlighted below:

1. A touch panel comprising a **transparent capacitive sensing medium** configured to detect multiple touches or near touches that occur at a same time and at distinct locations in a plane of the touch panel and to produce distinct signals representative of a location of the touches on the plane of the touch panel for each of the multiple touches, wherein the **transparent capacitive sensing medium** comprises:
 - a **first layer** having a plurality of **transparent first conductive lines** that are electrically isolated from one another;

⁶ We disagree with the ALJ's conclusion that Rekimoto '033 teaches the use of transparent electrodes. See *id.* at 174.

⁷ We do not review, and therefore do not address, the ID's findings concerning secondary considerations. ID at 176-177.

MAY CONTAIN CONFIDENTIAL BUSINESS INFORMATION

a **second layer** spatially separated from the **first layer** and having a plurality of **transparent second conductive lines** that are electrically isolated from one another, the second conductive lines being positioned transverse to the first conductive lines, the intersection of transverse lines being positioned at different locations in the plane of the touch panel, each of the second conductive lines being operatively coupled to capacitive monitoring circuitry;

wherein the capacitive monitoring circuitry is configured to detect changes in charge coupling between the first conductive lines and the second conductive lines.

4. The touch panel as recited in claim 1 wherein the **transparent first conductive lines** of the first layer are disposed on a first glass member, and wherein the **transparent second conductive lines** of the second layer are disposed on a second glass member, the first glass member being disposed over the second glass member.

6. The touch panel as recited in claim 1 wherein the conductive lines are formed from **indium tin oxide (ITO)**.

'607 Patent at 21:35-22:13.

Apple contends that SmartSkin discloses the use of only opaque, rather than transparent, sensors and that SmartSkin's purported disclosure of transparent ITO represents only speculative, future possibilities. The ID finds, and Apple does not dispute, that the use of ITO in creating transparent conductive lines or electrodes was well known at the time of the invention of the '607 Patent. See Final ID at 173. The evidence supports this conclusion. In particular, the SmartSkin reference, which is prior art to the '607 Patent, states that "most of today's flat panel displays rely on active-matrix and transparent electrodes[.]" JX-367 (SmartSkin) at 7. Motorola's expert, Dr. Wolfe, likewise testified that "two-layer sensors with rows and columns of ITO [are] standard products" (Wolfe, Tr. at 1391:11-22) and that "the use of transparent

MAY CONTAIN CONFIDENTIAL BUSINESS INFORMATION

electrodes . . . has been known in the art for twenty years” (RX-1885C (Wolfe Direct Witness Statement) at Q. 326).

In *KSR*, the Supreme Court stressed that, “[t]he combination of familiar elements according to known methods is likely to be obvious when it does no more than yield predictable results.” *KSR Int’l Co.*, 550 U.S. at 416. Here, the use of transparent ITO in combination with the mesh grid touch sensor of SmartSkin is just the type of “combination of familiar elements” that *KSR* discusses. See JX-367 at 7 and Fig. 2. Motorola’s expert, Dr. Wolfe, who has over twenty years of experience making capacitive touch overlay sensors using ITO, testified at the hearing precisely on this point as follows:

Q. Figure 2 [of SmartSkin] doesn’t show a transparent sensor, does it?

A. It is the same kind of drawing that’s in the ‘607 [Patent]. To a person who understands the technology, it doesn’t matter whether that sensor is transparent or opaque.

Q. But there is nothing in figure 2 that is a transparent sensor. In fact, if you read the whole thing, you know that the sensor that they are talking about in figure 2 is a non-transparent sensor, opaque, right?

A. No, you know that they describe how to build a sensor with rows and columns of conductors, and then they talk about a particular first embodiment they made that was opaque, and then how you could build a transparent one as well.

Wolfe, Tr. 1309:14-1310:5; see also *id.* at 1391:11-22 (“[t]wo-layer sensors with rows and columns of ITO were standard products, and I think that a person of ordinary skill, who we agree is a touchscreen engineer . . . would just read this to say this is an ordinary row and column ITO touch overlay that’s being used in a unique way in the SmartSkin product.”); *id.* 1392:20-1393:8 (stating that he has been making ITO touch screen products since 1983).

Apple’s expert, Dr. Subramanian, disputed this conclusion, testifying that SmartSkin

MAY CONTAIN CONFIDENTIAL BUSINESS INFORMATION

“provide[s] no instructions for how to ‘obtain’ a transparent sensor using ITO and . . . even the researchers working on the [SmartSkin] system who authored the article believed that such a transparent sensor was merely a future possibility[.]” CX-569C (Subramanian Rebuttal Witness Statement) at Q. 117. But the evidence supports the conclusion that using transparent ITO for the “transparent conductive lines” claimed in the ‘607 Patent and discussed in SmartSkin would have been within the ability of one of ordinary skill in the art. In particular, Dr. Wolfe testified as follows:

The ‘607 patent does not disclose any special characteristics of the ITO that make it suitable for use in the ‘607 patent; not its resistivity, capacitance, uniformity, thickness, or thermal characteristics. In any case, none of these need be disclosed since normal, commercially available and well known ITO materials are suitable for both SmartSkin and the ‘607 Patent.

RX-1885C at Q. 326; *see also* Wolfe, Tr. at 1390:19-1397:16 (discussing that one of ordinary skill in the art would know how to implement the SmartSkin sensor using transparent ITO electrodes).

Apple further contends that SmartSkin does not enable the use of a transparent ITO sensor with the multi-touch mutual-capacitance system disclosed in that reference because substituting transparent ITO conductive lines for the opaque copper lines used with one embodiment of the voltage-based sensing system of SmartSkin would require a complete redesign. *See* Subramanian, Tr. at 1533-34, 1536-39, 1574-84, 1585-97.⁸ Specifically, Apple’s

⁸ Motorola argued that Apple waived any argument concerning the different types of sensors used in the SmartSkin system and the system disclosed in the ‘607 Patent because Dr. Subramanian did not mention the issue in his witness statements and because Apple failed to raise the issue in its pre-hearing statement. During the hearing, Motorola belatedly objected to Dr. Subramanian’s testimony during his re-direct examination, but the ALJ ruled that the

MAY CONTAIN CONFIDENTIAL BUSINESS INFORMATION

expert, Dr. Subramanian, testified under cross-examination that, because the voltage-sensor used in the SmartSkin system receives very low strength signals, it is very sensitive to the resistance of the material used to conduct the current from the signal source to the receiver, hence the use of low resistance copper conductors in the SmartSkin system. Subramanian, Tr. at 1537:17-1538:17. Dr. Subramanian further explained that transparent ITO has such a high resistance and thus a lower conductivity – approximately 100 times less than copper – that ITO cannot be used successfully in a voltage-sensing system. *Id.*; *see also* JX-367 (SmartSkin) at Fig. 2; ‘607 Patent at Figs. 12, 13, 17:12-61. Dr. Subramanian compared the system disclosed in SmartSkin to the multi-touch system disclosed in the ‘607 Patent, which he explained uses a detector that counts charge in lieu of sensing voltage to account for the low conductivity of transparent ITO.

Subramanian, Tr. 1582:11-1584:7. Apple contends that, because of the different types of sensors used to implement the SmartSkin system and the system disclosed in the ‘607 Patent, it would not have been obvious to combine the two systems. *Id.* (citing Subramanian, Tr. at 1537:2-1539:10).

It is axiomatic that, in evaluating an assertion of obviousness, the correct comparison is between the prior art and the claims. *See Procter & Gamble Co. v. Teva Pharm. USA, Inc.*, 566 F.3d 989, 994 (Fed. Cir. 2009) (“A party seeking to invalidate a patent based on obviousness must prove by clear and convincing evidence ‘that a skilled artisan would have been motivated to combine the teachings of the prior art references *to achieve the claimed invention*, and that the skilled artisan would have had a reasonable expectation of success in doing so.’”) (emphasis

testimony was admissible. Tr. 1584:20-1585:7. We do not disturb the ALJ’s decision.

MAY CONTAIN CONFIDENTIAL BUSINESS INFORMATION

added). Apple's arguments concerning the different types of sensing systems used in SmartSkin and the '607 Patent ignore this basic principle.

The claim language of the '607 Patent recites "wherein the capacitive monitoring circuitry is configured to detect changes in charge coupling between the first conductive lines and the second conductive lines" (claim 1) and "a multipoint sensing arrangement configured to simultaneously detect and monitor the touch events and a change in capacitive coupling associated with those touch events at distinct points across the touch panel" (claim 10). '607 Patent at 21:53-55, 22:31-35. As such, Apple's arguments concerning the difficulty of implementing a transparent ITO sensor with a voltage-sensing system are irrelevant since the claimed invention is not drawn to a particular sensing arrangement. *See* '607 Patent at 17:12-35.⁹ In fact, Dr. Subramanian testified that counting charge "is not the only function that has to exist within the [claimed] capacitive monitoring circuitry." Subramanian, Tr. at 824:5-15.

Moreover, in discussing whether U.S. Patent No. 7,372,455 to Perski, et al. ("Perski '455") anticipates the asserted claims of the '607 Patent, Apple's expert, Dr. Subramanian, testified that Perski '455 discloses "a straight voltage amplifier, similar to that of [the SmartSkin

⁹ Although Motorola argued that the claim limitation "capacitive monitoring circuitry" of claim 1 required construction, the ALJ found that the term did not require construction because none of the issues surrounding the limitation (*i.e.*, whether the circuitry of the Accused '607 Products or the domestic industry products satisfy this limitation) were dependent on the construction of this limitation. *See* Final ID at 49, n. 6. Furthermore, the ALJ noted that the parties' proposed constructions of the limitation were similar such that there was no real distinction between them. *Id.* Specifically, Motorola and the IA proposed that "capacitive monitoring circuitry" means "circuitry that senses changes in capacitance," while Apple proposed that the limitation has its plain and ordinary meaning. *See* Respondent Motorola's Post-Hearing Brief at 19 (Oct. 19, 2011). Notably, none of the proposed constructions limited "capacitive monitoring circuitry" to a specific type of sensor.

MAY CONTAIN CONFIDENTIAL BUSINESS INFORMATION

reference].” Subramanian, Tr. at 1605:25-1606:2. Perski ‘455, by way of U.S. Patent Provisional Application No. 60/406,662 (“Morag ‘662) (filed in August 2002), which Perski ‘455 incorporates by reference, explicitly discloses the use of a voltage amplifier in a voltage-sensing system with high-resistance transparent electrodes. Specifically, Morag ‘662 explains as follows:

The resistance of the conductive lines is relatively high and it might exceed 100 KOhm for a line. Higher resistance of transparent conductors results in a higher transparency of the material. Therefore, it is a general object of the present invention to enable working with high resistance of the sensor grid.

RX-703 at 5 ¶ 2 (Morag ‘662). As this reference makes clear, the concept of using a voltage-sensing system with high-resistance transparent electrodes was known in the art at the time of the ‘607 Patent.

IV. CONCLUSION

For the reasons discussed above, the Commission finds that the asserted claims of the ‘607 Patent are obvious in view of SmartSkin in combination with Rekimoto ‘033.

By order of the Commission

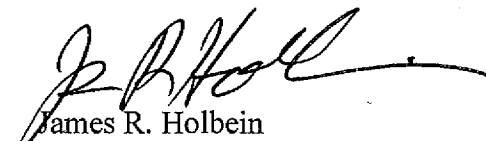
James R. Holbein
Secretary

Issued: March 28, 2012

CERTAIN MOBILE DEVICES AND RELATED SOFTWARE

Inv. No. 337-TA-750

CONFIDENTIAL CERTIFICATE OF SERVICE

I, James R. Holbein, hereby certify that the attached **COMMISSION OPINION** has been served by hand upon the Commission Investigative Attorney, Anne Goalwin, Esq., and the following parties as indicated on **March 28, 2012**.



James R. Holbein, Secretary
U.S. International Trade Commission
500 E Street, SW, Room 112
Washington, DC 20436

On Behalf of Complainant Apple Inc.:

Mark G. Davis, Esq.
WEIL, GOTSHALL & MANGES LLP
1300 Eye Street, NW, Suite 900
Washington, DC 20005

- Via Hand Delivery
- Via Overnight Delivery
- Via First Class Mail
- Other: _____

On Behalf of Respondent Motorola Mobility, Inc.:

Charles F. Schill, Esq.
STEPTOE & JOHNSON LLP
1330 Connecticut Avenue, NW
Washington, DC 20036

- Via Hand Delivery
- Via Overnight Delivery
- Via First Class Mail
- Other: _____

Patent No. 7,663,607,
Dated February 16, 2010

U 7265369

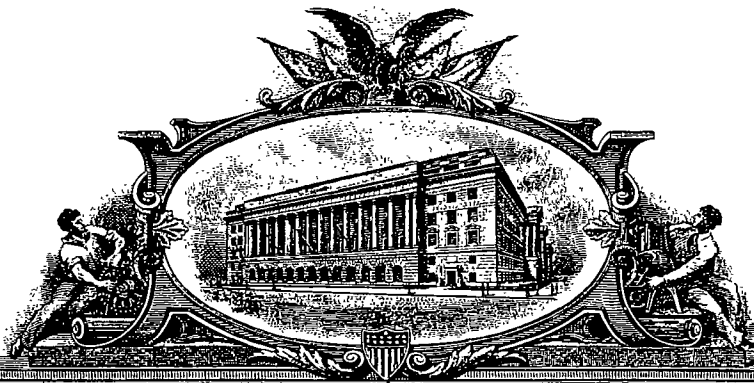

THE UNITED STATES OF AMERICA

TO ALL TO WHOM THESE PRESENTS SHALL COME:

UNITED STATES DEPARTMENT OF COMMERCE
United States Patent and Trademark Office

October 28, 2010

THIS IS TO CERTIFY THAT ANNEXED HERETO IS A TRUE COPY FROM
THE RECORDS OF THIS OFFICE OF:

U.S. PATENT: 7,663,607
ISSUE DATE: February 16, 2010

By Authority of the
Under Secretary of Commerce for Intellectual Property
and Director of the United States Patent and Trademark Office

M. TARVER
Certifying Officer





US007663607B2

(12) **United States Patent**
Hotelling et al.

(10) **Patent No.:** **US 7,663,607 B2**
(45) **Date of Patent:** **Feb. 16, 2010**

- (54) **MULTIPOINT TOUCHSCREEN**
- (75) Inventors: **Steve Hotelling**, San Jose, CA (US);
Joshua A. Strickon, San Jose, CA (US);
Brian Q. Huppi, San Francisco, CA (US)
- (73) Assignee: **Apple Inc.**, Cupertino, CA (US)
- (*) Notice: Subject to any disclaimer, the term of this patent is extended or adjusted under 35 U.S.C. 154(b) by 754 days.
- (21) Appl. No.: **10/840,862**
- (22) Filed: **May 6, 2004**

4,734,685 A	3/1988	Watanabe	340/710
4,746,770 A	5/1988	McAvinney	178/18
4,771,276 A	9/1988	Parks	340/712
4,788,384 A	11/1988	Bruere-Dawson et al	178/18
4,806,846 A	2/1989	Kerber	324/60 CD
4,898,555 A	2/1990	Sampson	445/22
4,914,624 A	4/1990	Dunthorn et al.	
4,968,877 A	11/1990	McAvinney et al.	250/221
5,003,519 A	3/1991	Noirjean	368/73
5,017,030 A	5/1991	Crews	400/485
5,178,477 A	1/1993	Gambaro	400/489
5,189,403 A	2/1993	Franz et al.	340/711
5,194,862 A	3/1993	Edwards	341/20
5,224,861 A	7/1993	Glass et al	434/35
5,241,308 A	8/1993	Young	341/34

(65) **Prior Publication Data**
US 2006/0097991 A1 May 11, 2006

(Continued)
FOREIGN PATENT DOCUMENTS
CA 1243096 10/1988 340/180

(51) **Int. Cl.**
G06F 3/041 (2006.01)
(52) **U.S. Cl.** 345/173; 345/174; 178/18.01
(58) **Field of Classification Search** 345/173-179;
178/18.01-18.04
See application file for complete search history.

(Continued)
OTHER PUBLICATIONS
U.S. Appl. No. 10/654,108, filed Sep. 2, 2003.

(56) **References Cited**
U.S. PATENT DOCUMENTS

3,333,160 A	7/1967	Gorski	
3,541,541 A	11/1970	Englebart	
3,662,105 A	5/1972	Hurst et al	178/18
3,798,370 A	3/1974	Hurst	178/18
4,246,452 A	1/1981	Chandler	200/5
4,550,221 A	10/1985	Mabuth	178/18
4,672,364 A	6/1987	Lucas	340/365 P
4,672,558 A	6/1987	Beckes et al.	364/518
4,692,809 A	9/1987	Beining et al.	358/247
4,695,827 A	9/1987	Beining et al.	340/365 P
4,733,222 A	3/1988	Evans	340/365 C

(Continued)
Primary Examiner—Richard Hjerpe
Assistant Examiner—Kimnhung Nguyen
(74) **Attorney, Agent, or Firm**—Morrison & Foerster LLP

(57) **ABSTRACT**
A touch panel having a transparent capacitive sensing medium configured to detect multiple touches or near touches that occur at the same time and at distinct locations in the plane of the touch panel and to produce distinct signals representative of the location of the touches on the plane of the touch panel for each of the multiple touches is disclosed.

11 Claims, 14 Drawing Sheets

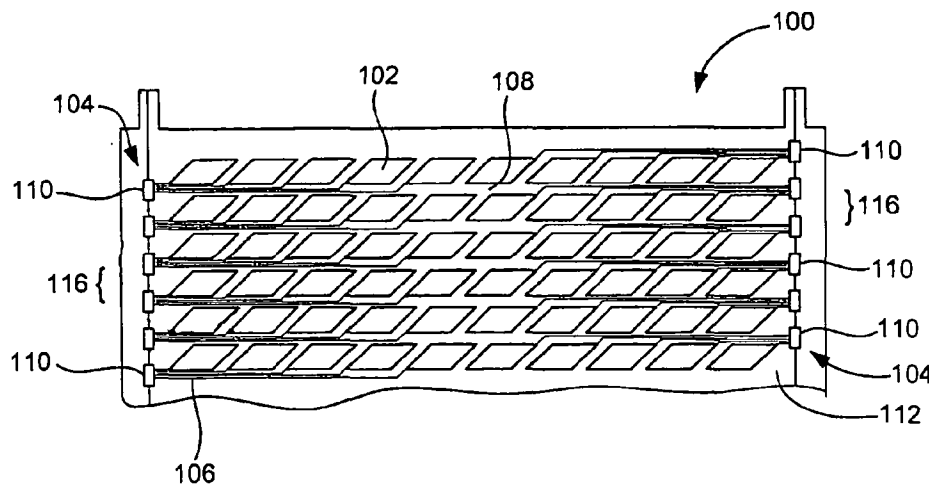

US 7,663,607 B2

U.S. PATENT DOCUMENTS

5,252,951 A	10/1993	Tannenbaum et al.	345/156	6,002,389 A	12/1999	Kasser	345/173
5,281,966 A	1/1994	Walsh	341/222	6,002,808 A	12/1999	Freeman	382/288
5,305,017 A	4/1994	Gerpheide	345/174	6,020,881 A	2/2000	Naughton et al.	345/327
5,345,543 A	9/1994	Capps et al.	395/137	6,031,524 A	2/2000	Kunert	345/173
5,376,948 A	12/1994	Roberts	345/173	6,037,882 A	3/2000	Levy	341/20
5,398,310 A	3/1995	Tchao et al.	395/144	6,050,825 A	4/2000	Nichol et al.	434/227
5,442,742 A	8/1995	Greyson et al.	395/146	6,052,339 A	4/2000	Frenkel et al.	368/230
5,463,388 A	10/1995	Boie et al.	341/33	6,061,177 A *	5/2000	Fujimoto	359/443
5,463,696 A	10/1995	Beemink et al.	382/186	6,072,494 A	6/2000	Nguyen	345/358
5,483,261 A	1/1996	Yasutake	345/173	6,084,576 A	7/2000	Leu et al.	345/168
5,488,204 A	1/1996	Mead et al.	178/18	6,107,997 A	8/2000	Ure	345/173
5,495,077 A	2/1996	Miller et al.	178/18	6,128,003 A	10/2000	Smith et al.	345/157
5,513,309 A	4/1996	Meier et al.	395/155	6,131,299 A	10/2000	Raab et al.	33/503
5,523,775 A	6/1996	Capps	345/179	6,135,958 A	10/2000	Mikula-Curtis et al.	600/443
5,530,455 A	6/1996	Gillick et al.	345/163	6,144,380 A	11/2000	Shwartz et al.	345/350
5,543,590 A	8/1996	Gillespie et al.	178/18	6,188,391 B1	2/2001	Seely et al.	
5,543,591 A	8/1996	Gillespie et al.	178/18	6,198,515 B1	3/2001	Cole	348/836
5,563,632 A	10/1996	Roberts	345/173	6,208,329 B1	3/2001	Ballare	345/173
5,563,996 A	10/1996	Tchao	395/144	6,222,465 B1	4/2001	Kumar et al.	341/20
5,565,658 A	10/1996	Gerpheide et al.	178/19	6,239,790 B1	5/2001	Martinelli et al.	345/174
5,579,036 A	11/1996	Yates, IV	345/173	6,243,071 B1	6/2001	Shwartz et al.	345/146
5,581,681 A	12/1996	Tchao	395/804	6,246,862 B1	6/2001	Grivas et al.	455/90
5,583,946 A	12/1996	Gourdol	382/187	6,249,606 B1	6/2001	Kiraly et al.	382/195
5,589,856 A	12/1996	Stein et al.		6,288,707 B1	9/2001	Philipp	345/168
5,590,219 A	12/1996	Gourdol	382/202	6,289,326 B1	9/2001	LaFleur	705/702
5,592,566 A	1/1997	Pagallo et al.	382/187	6,292,178 B1	9/2001	Bernstein et al.	345/173
5,594,810 A	1/1997	Gourdol	382/187	6,323,846 B1	11/2001	Westerman et al.	
5,596,694 A	1/1997	Capps	395/152	6,337,678 B1	1/2002	Fish	
5,612,719 A	3/1997	Beemink et al.	345/173	6,347,290 B1	2/2002	Bartlett	702/150
5,631,805 A	5/1997	Bonsall	361/681	6,377,009 B1	4/2002	Philipp	318/468
5,633,955 A	5/1997	Bozinovic et al.	381/187	6,380,931 B1	4/2002	Gillespie et al.	345/173
5,634,102 A	5/1997	Capps	395/334	6,411,287 B1	6/2002	Scharff et al.	345/177
5,636,101 A	6/1997	Bonsall et al.	361/681	6,414,671 B1	7/2002	Gillespie et al.	345/157
5,642,108 A	6/1997	Gopher et al.	341/22	6,421,234 B1	7/2002	Ricks et al.	361/683
5,644,657 A	7/1997	Capps et al.	382/229	6,452,514 B1	9/2002	Philipp	341/33
5,666,113 A	9/1997	Logan	341/34	6,457,355 B1	10/2002	Philipp	73/304
5,666,502 A	9/1997	Capps	345/352	6,466,036 B1	10/2002	Philipp	324/678
5,666,552 A	9/1997	Grayson et al.	395/802	6,515,669 B1	2/2003	Mohri	345/474
5,675,361 A	10/1997	Santilli	345/168	6,525,749 B1	2/2003	Moran et al.	345/863
5,677,710 A	10/1997	Thompson-Rohrlich	345/173	6,535,200 B2	3/2003	Philipp	345/168
5,689,253 A	11/1997	Hargreaves et al.	341/22	6,543,684 B1	4/2003	White et al.	234/379
5,710,844 A	1/1998	Capps et al.	382/317	6,543,947 B2	4/2003	Lee	400/489
5,729,250 A	3/1998	Bishop et al.	345/175	6,570,557 B1	5/2003	Westerman et al.	
5,730,165 A	3/1998	Philipp	137/1	6,593,916 B1	7/2003	Aroyan	
5,736,976 A	4/1998	Cheung	345/168	6,610,936 B2	8/2003	Gillespie et al.	178/18.01
5,741,990 A	4/1998	Davies	84/423 R	6,624,833 B1	9/2003	Kumar et al.	345/863
5,745,116 A	4/1998	Pisutha-Armond	345/358	6,639,577 B2	10/2003	Eberhard	345/102
5,745,716 A	4/1998	Tchao et al.	395/350	6,650,319 B1	11/2003	Hurst et al.	
5,746,818 A	5/1998	Yatake	106/31.86	6,658,994 B1	12/2003	McMillan	99/468
5,748,269 A	5/1998	Harris et al.	349/58	6,670,894 B2	12/2003	Mehring	341/22
5,764,222 A	6/1998	Shieh	345/173	6,677,932 B1	1/2004	Westerman	
5,767,457 A	6/1998	Gerpheide et al.	178/18	6,677,934 B1	1/2004	Blanchard	345/173
5,767,842 A	6/1998	Korth	345/168	6,723,929 B2	4/2004	Kent	
5,790,104 A	8/1998	Shieh	345/173	6,724,366 B2	4/2004	Crawford	345/157
5,790,107 A	8/1998	Kasser et al.	345/174	6,757,002 B1	6/2004	Oross et al.	345/864
5,802,516 A	9/1998	Shwartz et al.	707/6	6,803,906 B1	10/2004	Morrison et al.	345/173
5,808,567 A	9/1998	McCloud	341/20	6,842,672 B1	1/2005	Straub et al.	701/3
5,809,267 A	9/1998	Moran et al.	395/358	6,856,259 B1 *	2/2005	Sharp	341/5
5,821,690 A	10/1998	Martens et al.	313/506	6,888,536 B2 *	5/2005	Westerman et al.	345/173
5,821,930 A	10/1998	Hansen	345/340	6,900,795 B1	5/2005	Knight, III et al.	345/173
5,823,782 A	10/1998	Marcus et al.	434/156	6,927,761 B2	8/2005	Badaye et al.	345/173
5,825,351 A	10/1998	Tam		6,942,571 B1	9/2005	McAllister et al.	463/20
5,825,352 A	10/1998	Bisset et al.	345/173	6,965,375 B1	11/2005	Gettemy et al.	345/173
5,854,625 A	12/1998	Frisch et al.	345/173	6,972,401 B2	12/2005	Akitt et al.	250/221
5,880,411 A	3/1999	Gillespie et al.	178/18.01	6,977,666 B1	12/2005	Hedrick	345/690
5,898,434 A	4/1999	Small et al.	345/348	6,985,801 B1	1/2006	Straub et al.	701/3
5,920,309 A	7/1999	Bisset et al.	345/173	6,992,659 B2	1/2006	Gettemy	345/173
5,923,319 A	7/1999	Bishop et al.	345/175	7,030,860 B1 *	4/2006	Hsu et al.	345/173
5,933,134 A	8/1999	Shieh	345/173	7,031,228 B2	4/2006	Born et al.	368/69
5,942,733 A	8/1999	Allen et al.		2002/0015024 A1 *	2/2002	Westerman et al.	345/173
5,943,044 A	8/1999	Martinelli et al.	345/174	2002/0118848 A1	8/2002	Karpenstein	381/119
				2003/0006974 A1	1/2003	Clough et al.	345/179
				2003/0076301 A1	4/2003	Tsuk et al.	345/159

US 7,663,607 B2

Page 3

2003/0076303	A1	4/2003	Huppi	345/163
2003/0076306	A1	4/2003	Zadesky et al.	345/173
2003/0095095	A1	5/2003	Phlaja	345/156
2003/0095096	A1	5/2003	Robbin et al.	345/156
2003/0098858	A1	5/2003	Perski et al.	345/173
2003/0206202	A1	11/2003	Moriya	345/846
2003/0234768	A1	12/2003	Rekimoto et al.	345/169
2003/0234770	A1*	12/2003	MacKcy	345/173
2004/0227736	A1*	11/2004	Kamrath et al.	345/173
2004/0263484	A1	12/2004	Mantysalo et al.	345/173
2005/0007349	A1*	1/2005	Vakil et al.	345/173
2005/0012723	A1	1/2005	Pallakoff	345/173
2005/0052425	A1	3/2005	Zadesky et al.	345/173
2005/0083307	A1*	4/2005	Aufderheide et al.	345/173
2005/0104867	A1	5/2005	Westerman et al.	345/173
2005/0110768	A1	5/2005	Marriott et al.	345/173
2005/0146511	A1*	7/2005	Hill et al.	345/173
2006/0022955	A1	2/2006	Kennedy	345/173
2006/0022956	A1	2/2006	Lengeling et al.	345/173
2006/0026521	A1	2/2006	Hotelling et al.	715/702
2006/0026535	A1	2/2006	Hotelling et al.	715/863
2006/0026536	A1	2/2006	Hotelling et al.	715/863
2006/0032680	A1	2/2006	Elias et al.	178/18 06
2006/0033724	A1	2/2006	Chaudhri et al.	345/173
2006/0053387	A1	3/2006	Ording	715/773
2006/0066582	A1	3/2006	Lyon et al.	345/173
2006/0085757	A1	4/2006	Andre et al.	715/771
2006/0097991	A1	5/2006	Hotelling et al.	345/173
2006/0197753	A1	9/2006	Hotelling	345/173

FOREIGN PATENT DOCUMENTS

DE	102 51 296	5/2004
EP	0 156 593	10/1985
EP	0 250 931	1/1988
EP	0 288 692	7/1993
EP	0 664 504	1/1995
EP	0 464 908	9/1996
EP	1 014 295	1/2002
JP	59-214941	12/1984
JP	60-211529	10/1985
JP	08-016307	1/1996
JP	2000-112642	4/2000
JP	2002-342033	11/2002
JP	2003-029899	1/2003
WO	97/18547	5/1997
WO	97/23738	7/1997
WO	98/14863	4/1998
WO	WO-01/27868	A1 4/2001
WO	03/088176	10/2003
WO	WO-2004/013833	A2 2/2004
WO	WO-2004/013833	A3 2/2004
WO	WO-2005/114369	A2 12/2005
WO	WO-2005/114369	A3 12/2005
WO	2006/023569	3/2006

OTHER PUBLICATIONS

U.S. Appl. No. 10/789,676, filed Feb. 27, 2004.
 U.S. Appl. No. 10/903,964, filed Jul. 30, 2004.
 U.S. Appl. No. 11/015,978, filed Dec. 17, 2004
 U.S. Appl. No. 11/038,590, filed Jan. 18, 2005.
 U.S. Appl. No. 11/048,264, filed Jan. 31, 2005
 "Touch Technologies Overview," 2001, 3M Touch Systems, Massachusetts.
 "Touchscreen Technology Choices," <http://www.elotouch.com/products/detech2.asp>, downloaded Aug. 5, 2005.
 Jun Rekimoto. "SmartSkin: An Infrastructure for Freehand Manipulation on Interactive Surfaces," CHI 2002, Apr. 20-25, 2002, Minneapolis, Minnesota.
 "Wacom Components—Technology," <http://www.wacomcomponents.com/english/tech.asp>, downloaded Oct. 10, 2004.

"Comparing Touch Technologies," <http://www.touchscreens.com/intro-touchtypes.html>, downloaded Oct. 10, 2004.
 "GlidePoint®," http://www.cirque.com/technology/technology_gp.htm, downloaded Aug. 5, 2005.
 "Captive Position Sensing," <http://www.synaptics.com/technology/cps.cfm>, downloaded Aug. 5, 2005.
 "How do touchscreen monitors know where you're touching?," <http://electronics.howstuffworks.com/question716.htm>, downloaded Aug. 5, 2005.
 "How Does a Touchscreen Work?," <http://www.touchscreens.com/intro-anatomy.html>, downloaded Aug. 5, 2005.
 "4-Wire Resistive Touchscreens," <http://www.touchscreens.com/intro-touchtypes-4resistive.html>, downloaded Aug. 5, 2005.
 "5-Wire Resistive Touchscreens," <http://www.touchscreens.com/intro-touchtypes-resistive.html>, downloaded Aug. 5, 2005.
 "Capacitive Touchscreens," <http://www.touchscreens.com/intro-touchtypes-capacitive.html>, downloaded Aug. 5, 2005.
 "Pen Touch Capacitive Touchscreens," <http://www.touchscreens.com/intro-touchtypes-pentouch.html>, downloaded Aug. 5, 2005.
 "Surface Acoustic Wave Touchscreens," <http://www.touchscreens.com/intro-touchtypes-saw.html>, downloaded Aug. 5, 2005.
 "Near Field Imaging Touchscreens," <http://www.touchscreens.com/intro-touchtypes-nfi.html>, downloaded Aug. 5, 2005.
 "Infrared Touchscreens," <http://www.touchscreens.com/intro-touchtypes-infrared.html>, downloaded Aug. 5, 2005.
 "Watershed Algorithm," <http://rsb.info.nih.gov/ij/plugins/watershed.html>, downloaded Aug. 5, 2005.
 U.S. Appl. No. 10/654,108, filed Sep. 2, 2003 entitled "Ambidextrous Mouse".
 U.S. Appl. No. 10/789,676, filed Feb. 27, 2004 entitled "Shape Detecting Input Device".
 "4-Wire Resistive Touchscreens" obtained from <http://www.touchscreens.com/intro-touchtypes-4resistive.html> generated Aug. 5, 2005.
 "5-Wire Resistive Touchscreens" obtained from <http://www.touchscreens.com/intro-touchtypes-resistive.html> generated Aug. 5, 2005.
 "A Brief Overview of Gesture Recognition" obtained from http://www.dai.ed.ac.uk/Cvonline/LOCA_COPIES/COHEN/gesture_overview.html, generated Apr. 20, 2004.
 "Capacitive Touchscreens" obtained from <http://www.touchscreens.com/intro-touchtypes-capacitive.html> generated Aug. 5, 2005.
 "Capacitive Position Sensing" obtained from <http://www.synaptics.com/technology/cps.cfm> generated Aug. 5, 2005.
 "Comparing Touch Technologies" obtained from <http://www.touchscreens.com/intro-touchtypes.html> generated Oct. 10, 2004.
 "Gesture Recognition" http://www.fingerworks.com/gesture_recognition.html.
 "GlidePoinar®" obtained from http://www.cirque.com/technology/technology_gp.html generated Aug. 5, 2005.
 "How do touchscreen monitors know where you're touching?" obtained from <http://www.electronics.howstuffworks.com/question716.html> generated Aug. 5, 2005.
 "How does a touchscreen work?" obtained from <http://www.touchscreens.com/intro-anatomy.html> generated Aug. 5, 2005.
 "iGesture Products for Everyone (learn in minutes) Product Overview" FingerWorks.com.
 "Infrared Touchscreens" obtained from <http://www.touchscreens.com/intro-touchtypes-infrared.html> generated Aug. 5, 2005
 "Mouse Emulation" FingerWorks obtained from http://www.fingerworks.com/gesture_guide_mouse.html generated Aug. 30, 2005
 "Mouse Gestures in Opera" obtained from <http://www.opera.com/products/desktop/mouse/index.dml> generated Aug. 30, 2005.
 "Mouse Gestures," Optim oz, May 21, 2004.
 "Multi Touch Overview" FingerWorks obtained from <http://www.fingerworks.com/multoverview.html> generated Aug. 30, 2005.
 "Near Field Imaging Touchscreens" obtained from <http://www.touchscreens.com/intro-touchtypes-nfi.html> generated Aug. 5, 2005.
 "Pen Touch Capacitive Touchscreens" obtained from <http://www.touchscreens.com/intro-touchtypes-pentouch.html> generated Aug. 5, 2005.

US 7,663,607 B2

Page 4

- "Surface Acoustic Wave Touchscreens" obtained from <http://www.touchscreens.com/intro-touchtypes-saw.html> generated Aug 5, 2005.
- "Symbol Commander" obtained from <http://www.sensiva.com/symbolcommander/> generated Aug 30, 2005.
- "Tips for Typing" FingerWorks http://www.fingerworks.com/mini_typing.html generated Aug. 30, 2005
- "Touch Technologies Overview" 2001, 3M Touch Systems, Massachusetts.
- "Wacom Components—Technology" obtained from <http://www.wacom-components.com/english/tech.asp> generated on Oct. 10, 2004.
- "Watershed Algorithm" <http://rsb.info.nih.gov/ij/plugins/watershed.html> generated Aug. 5, 2005.
- "FingerWorks—Gesture Guide—Application Switching," obtained from http://www.fingerworks.com/gesture_guide_apps.html, generated on Aug 27, 2004, 1-pg.
- "FingerWorks—Gesture Guide—Editing," obtained from http://www.fingerworks.com/gesture_guide_editing.html, generated on Aug 27, 2004, 1-pg.
- "FingerWorks—Gesture Guide—File Operations," obtained from http://www.fingerworks.com/gesture_guide_files.html, generated on Aug 27, 2004, 1-pg.
- "FingerWorks—Gesture Guide—Text Manipulation," obtained from http://www.fingerworks.com/gesture_guide_text_manip.html, generated on Aug. 27, 2004, 2-pg.
- "FingerWorks—Gesture Guide—Tips and Tricks," obtained from http://www.fingerworks.com/gesture_guide_tips.html, generated Aug. 27, 2004, 2-pgs.
- "FingerWorks—Gesture Guide—Web," obtained from http://www.fingerworks.com/gesture_guide_web.html, generated on Aug. 27, 2004, 1-pg.
- "FingerWorks—Guide to Hand Gestures for USB Touchpads," obtained from http://www.fingerworks.com/igesture_userguide.html, generated Aug. 27, 2004, 1-pg.
- "FingerWorks—iGesture—Technical Details," obtained from http://www.fingerworks.com/igesture_tech.html, generated Aug. 27, 2004, 1-pg.
- "FingerWorks—The Only Touchpads with Ergonomic Full-Hand Resting and Relaxation!" obtained from <http://www.fingerworks.com/resting.html>, Copyright 2001, 1-pg
- "FingerWorks—Tips for Typing on the Mini," obtained from http://www.fingerworks.com/mini_typing.html, generated on Aug. 27, 2004, 2-pgs.
- "iGesture Pad—the MultiFinger USB TouchPad with Whole-Hand Gestures," obtained from <http://www.fingerworks.com/igesture.html>, generated Aug. 27, 2004, 2-pgs
- Bier, et al., "Toolglass and Magic Lenses. The see-through interface" In James Kijrya, editor, *Computer Graphics (SIGGRAPH '93 Proceedings)*, vol. 27, pp 73-80, Aug 1993.
- Douglas et al., *The Ergonomics of Computer Pointing Devices* (1997).
- European Search Report received in EP 1 621 989 (@ *Beyer Weaver & Thomas, LLP*) dated Mar. 27, 2006.
- EVB Elektronik "TS0P6238 IR Receiver Modules for Infrared Remote Control Systems" dated Jan. 2004 1-pg.
- Fisher et al., "Repetitive Motion Disorders: The Design of Optimal Rate- Rest Profiles." *Human Factors*, 35(2),283-304 (Jun. 1993).
- Fukuunoto, et al., "ActiveClick: Tactile Feedback for Touch Panels." in CHI 2001 Summary, pp 121-122, 2001.
- Fukumoto and Yoshinobu Tomomura. "Body Coupled Fingering Wireless Wearable Keyboard." *CHI 97*, pp. 147-154 (Mar. 1997).
- Hardy. "Fingerworks" Mar 7, 2002; BBC World On Line.
- Hillier and Gerald J. Lieberman, *Introduction to Operations Research* (1986).
- International Search Report dated Mar. 3, 2006 (PCT/US 05/03325, 119-0052WO).
- Jacob et al., "Integrality and Separability of Input Devices," *ACM Transactions on Computer-Human Interaction*, 1:3-26 (Mar. 1994).
- Kinkley et al., "Touch-Sensing Input Devices," in CHI '99 Proceedings, pp 223-230, 1999
- Kionx "KXP84 Series Summary Data Sheet" copyright 2005,dated Oct. 21, 2005, 4-pgs.
- Lee et al., "A Multi-Touch Three Dimensional Touch-Sensitive Tablet," in CHI '85 Proceedings, pp 121-128, 2000.
- Lee. "A Fast Multiple-Touch-Sensitive Input Device," Master's Thesis, University of Toronto (1984).
- Matsushita et al., "HoloWall: Designing a Finger, Hand, Body and Object Sensitive Wall," In Proceedings of UIST '97, Oct. 1997.
- Quantum Research Group "QT510 / QWheel™ Touch Slider IC" copyright 2004-2005. 14-pgs.
- Quek, "Unencumbered Gestural Interaction," *IEEE Multimedia*, 3:36-47 (Winter 1996).
- Radwin. "Activation Force and Travel Effects on Overexertion in Repetitive Key Tapping," *Human Factors*, 39(1):130-140 (Mar. 1997).
- Rekimoto "SmartSkin: An Infrastructure for Freehand Manipulation on Interactive Surfaces" CHI 2002, Apr. 20-25, 2002.
- Rekimoto et al , "ToolStone: Effective Use of the Physical Manipulation Vocabularies of Input Devices," In Proc. Of UIST 2000, 2000.
- Rubine et al., "Programmable Finger-Tracking Instrument Controllers," *Computer Music Journal*, vol 14, No. 1 (Spring 1990).
- Rutledge et al., "Force-To-Motion Functions for Pointing," *Human-Computer Interaction—INTERACT* (1990).
- Subatai Ahmad, "A Usable Real-Time 3D Hand Tracker," Proceedings of the 28th Asilomar Conference on Signals, Systems and Computers—Part 2 (of2), vol. 2 (Oct. 1994).
- Texas Instruments "TSC2003 / I2C Touch Screen Controller" Data Sheet SBAS 162, dated Oct. 2001. 20-pgs.
- Wellner, "The Digital Desk Calculators: Tangible Manipulation on a Desk Top Display" in ACM UIST '91 Proceedings, pp 27-34, Nov. 1991.
- Williams, "Applications for a Switched-Capacitor Instrumentation Building Block" Linear Technology Application Note 3, Jul. 1985, pp. 1-16.
- Yamada et al., "A Switched-Capacitor Interface for Capacitive Pressure Sensors" *IEEE Transactions on Instrumentation and Measurement*, vol. 41, No. 1, Feb. 1992, pp. 81-86.
- Yeh et al., "Switched Capacitor Interface Circuit for Capacitive Transducers" 1985 IEEE.
- Zhai et al., "Dual Stream Input for Pointing and Scrolling," *Proceedings of CHI '97 Extended Abstracts* (1997).
- Zimmerman et al , "Applying Electric Field Sensing to Human-Computer Interfaces," In CHI '85 Proceedings, pp 280-287, 1995.
- U.S. Appl. No. 10/774,053, filed Feb. 5, 2004.
- U.S. Appl. No. 11/140,529, filed May 27, 2005 which is a Reissue of 6,570,557 listed above.
- U.S. Appl. No. 11/381,313, filed May 2, 2006 entitled "Multipoint Touch Surface Controller".
- U.S. Appl No. 11/332,861, filed Jan. 13, 2006 which is a Reissue of 6,677,932 listed above.
- U.S. Appl. No. 11/380,109, filed Apr. 25, 2006 entitled "Keystroke Tacitility Arrangement on Smooth Touch Surface."
- U.S. Appl. No. 11/428,501, filed Jul. 3, 2006 entitled "Capacitive Sensing Arrangement," which is a Continuation of US 2005/0104867 listed above.
- U.S. Appl. No. 11/428,503, filed Jul. 3, 2006 entitled "Touch Surface" which is a Continuation of US 2005/0104867 listed above.
- U.S. Appl. No. 11/428,506, filed Jul. 3, 2006 entitled "User Interface Gestures" which is a Continuation of US 2005/0104867 listed above.
- U.S. Appl No 11/428,515, filed Jul. 3, 2006 entitled "User Interface Gestures" which is a Continuation of US 2005/0104867 listed above.
- U.S. Appl No 11/428,522, filed Jul 3, 2006 entitled "Identifying Contacts on a Touch Surface" which is a Continuation of US 2005/0104867 listed above.
- U.S. Appl. No. 11/428,521, filed Jul. 3, 2006 entitled "Identifying Contacts on a Touch Surface" which is a Continuation of US 2005/0104867 listed above.
- U.S. Appl. No. 11/426,078, filed Jun 23, 2006 entitled "Electronic Device Having Display and Surrounding Touch Sensitive Bezel for User Interface and Control" which is a Continuation-In-Part of 2006/0197753 listed above.

US 7,663,607 B2

Page 5

U.S. Appl. No. 11/278,080, filed Mar. 30, 2006 entitled "Force Imaging Input Device and System".

U.S. Appl. No. 11/382,402, filed May 9, 2006 entitled "Force and Location Sensitive Display" which is a Continuation of U.S. Appl. No. 11/278,080 listed above

International Search Report received in corresponding PCT application No. PCT/US2006/008349 Oct. 6, 2006.

International search report for International Application No. PCT/US2005/014364 mailed Jan 12, 2005

U.S. Appl. No. 12/267,522, filed Nov. 7, 2008, by Hotelling et al.

U.S. Appl. No. 12/267,532, filed Nov. 7, 2008, by Hotelling et al.

U.S. Appl. No. 12/267,540, filed Nov. 7, 2008, by Hotelling et al.

* cited by examiner

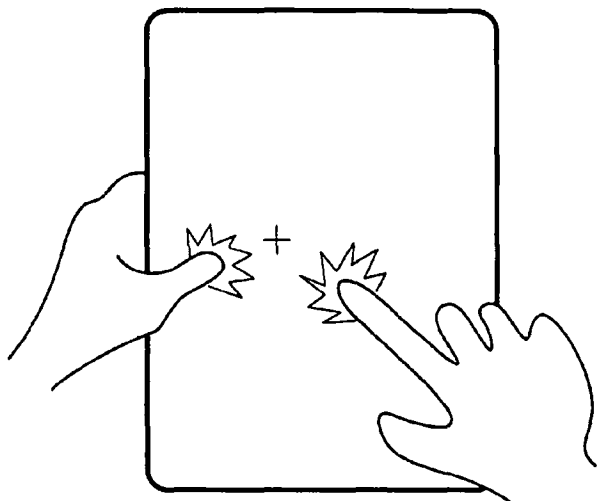

FIG. 1A

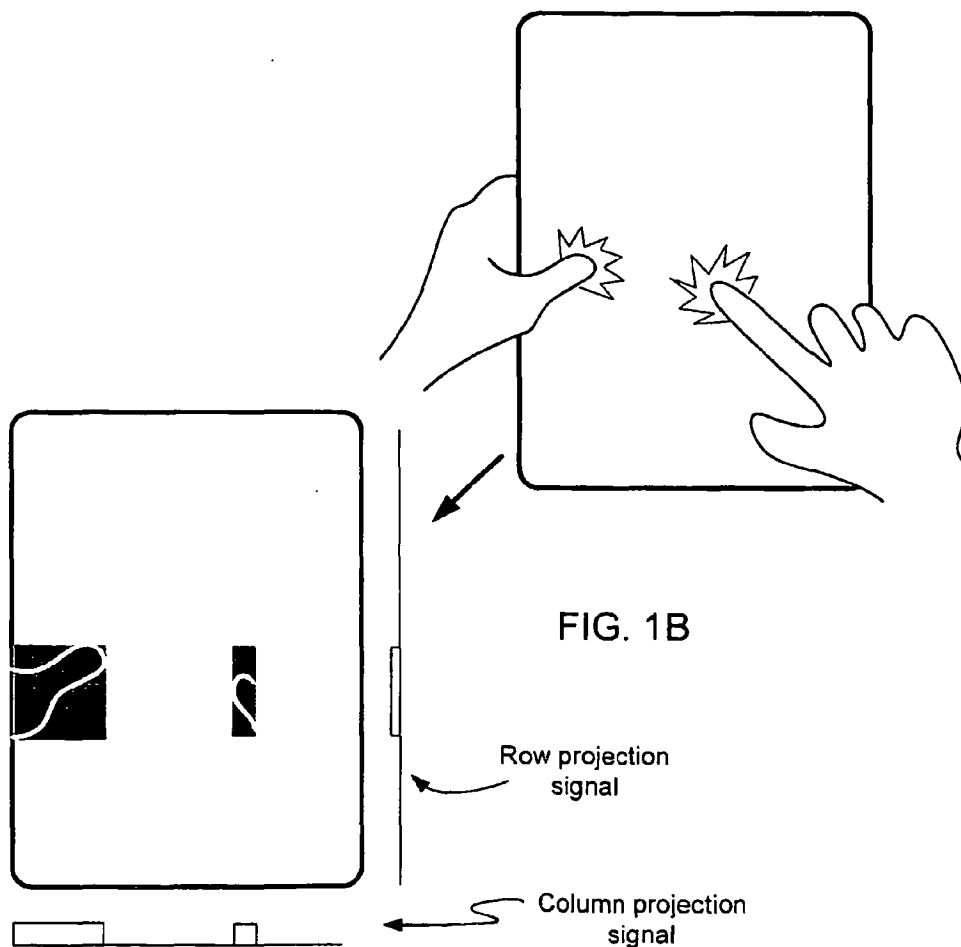

FIG. 1B

U.S. Patent

Feb. 16, 2010

Sheet 2 of 14

US 7,663,607 B2

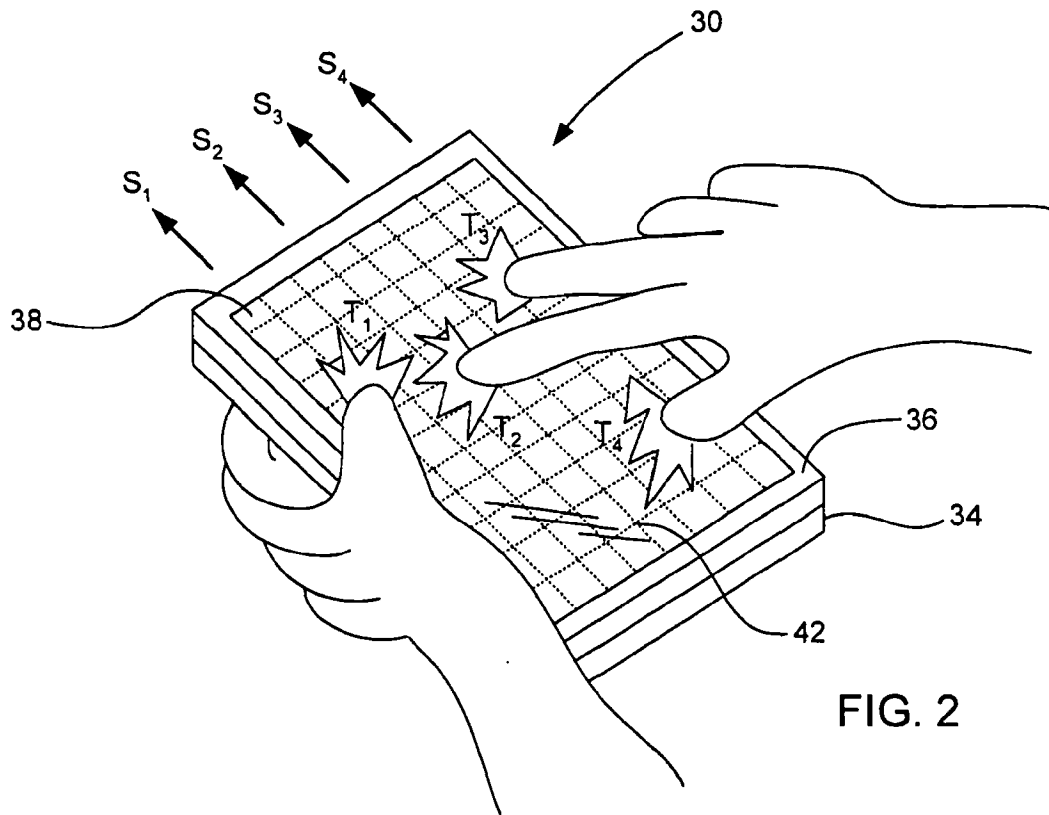

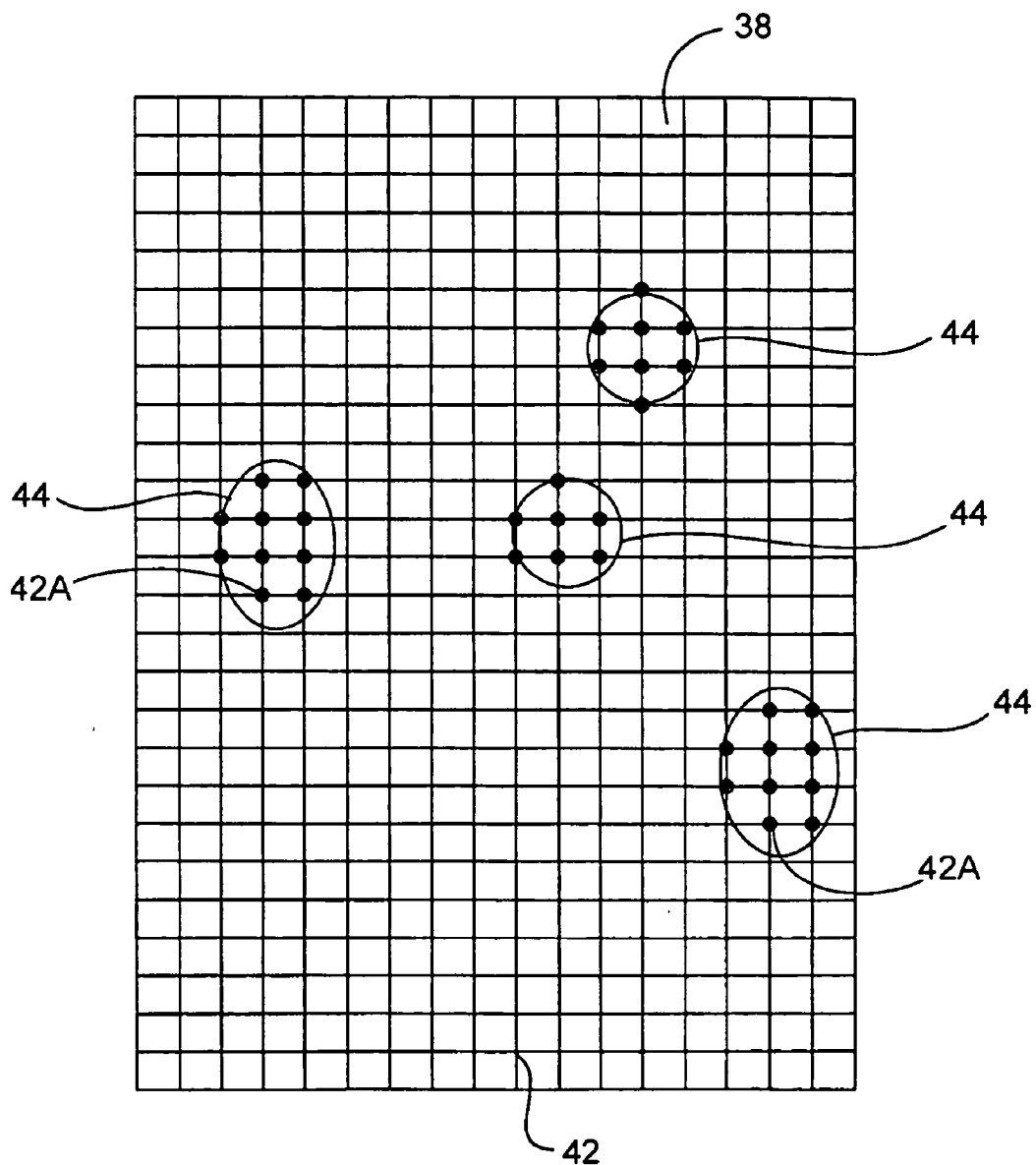

FIG. 3

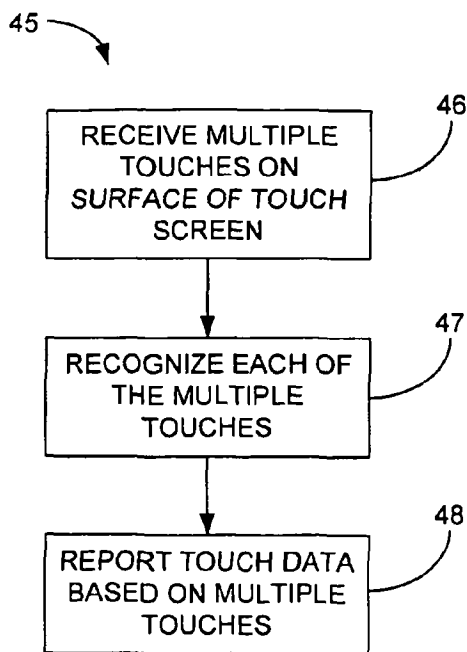

FIG. 4

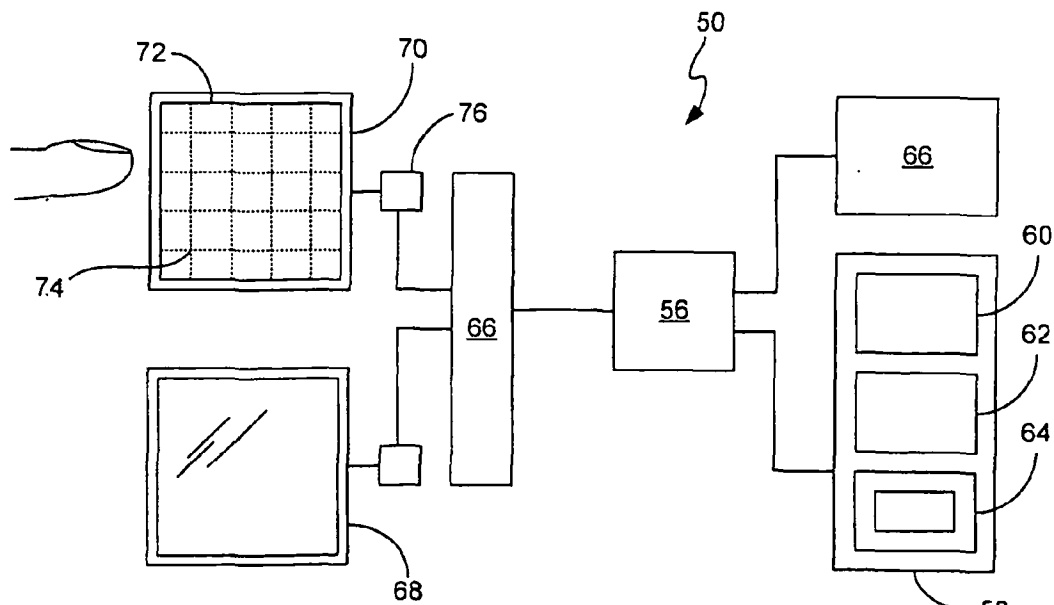

FIG. 5

U.S. Patent

Feb. 16, 2010

Sheet 5 of 14

US 7,663,607 B2

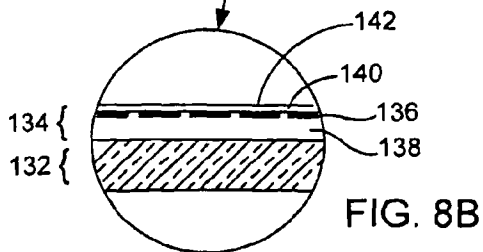
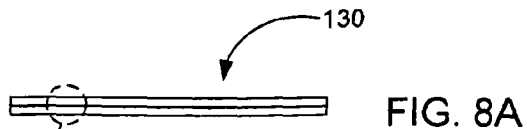
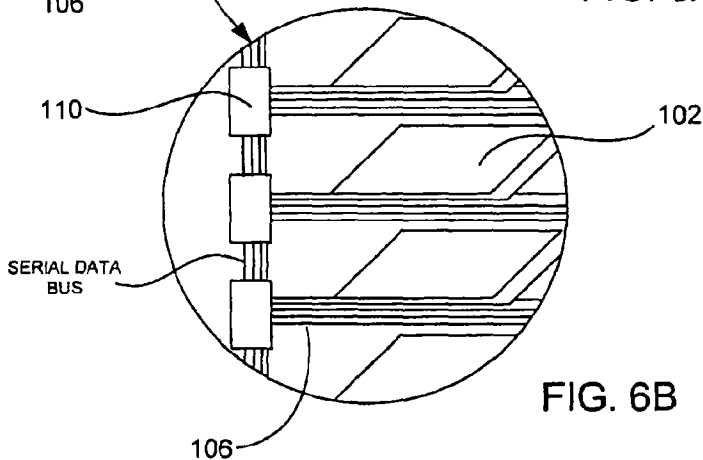
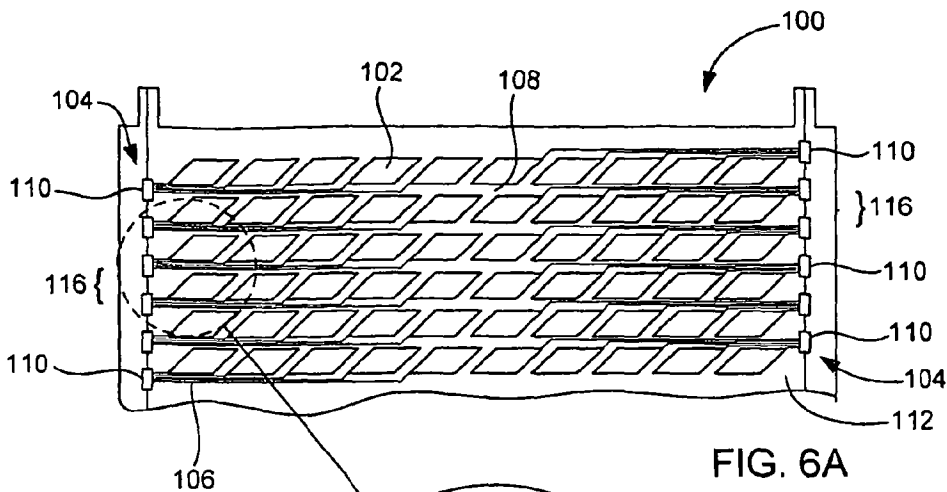

U.S. Patent

Feb. 16, 2010

Sheet 6 of 14

US 7,663,607 B2

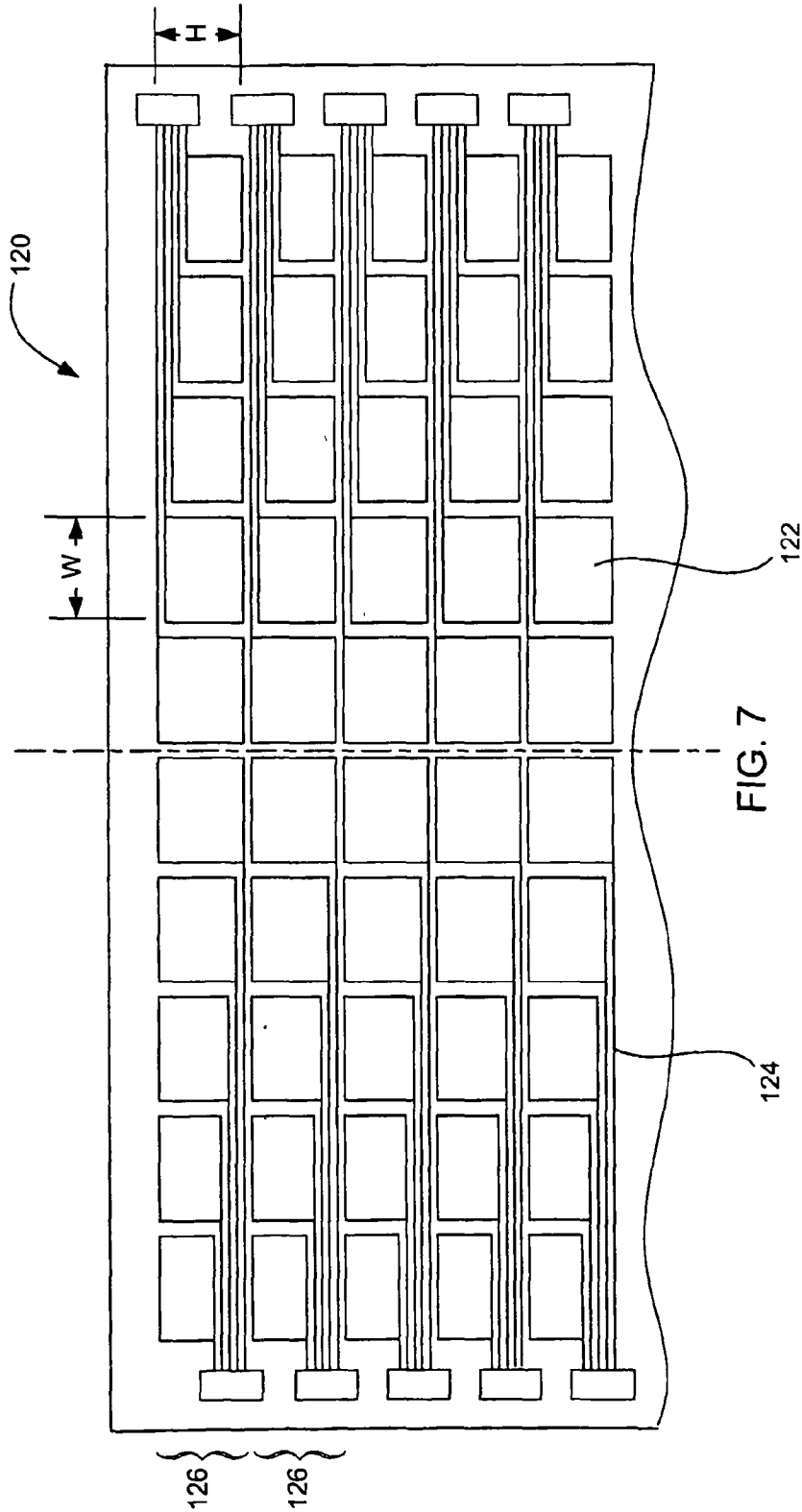

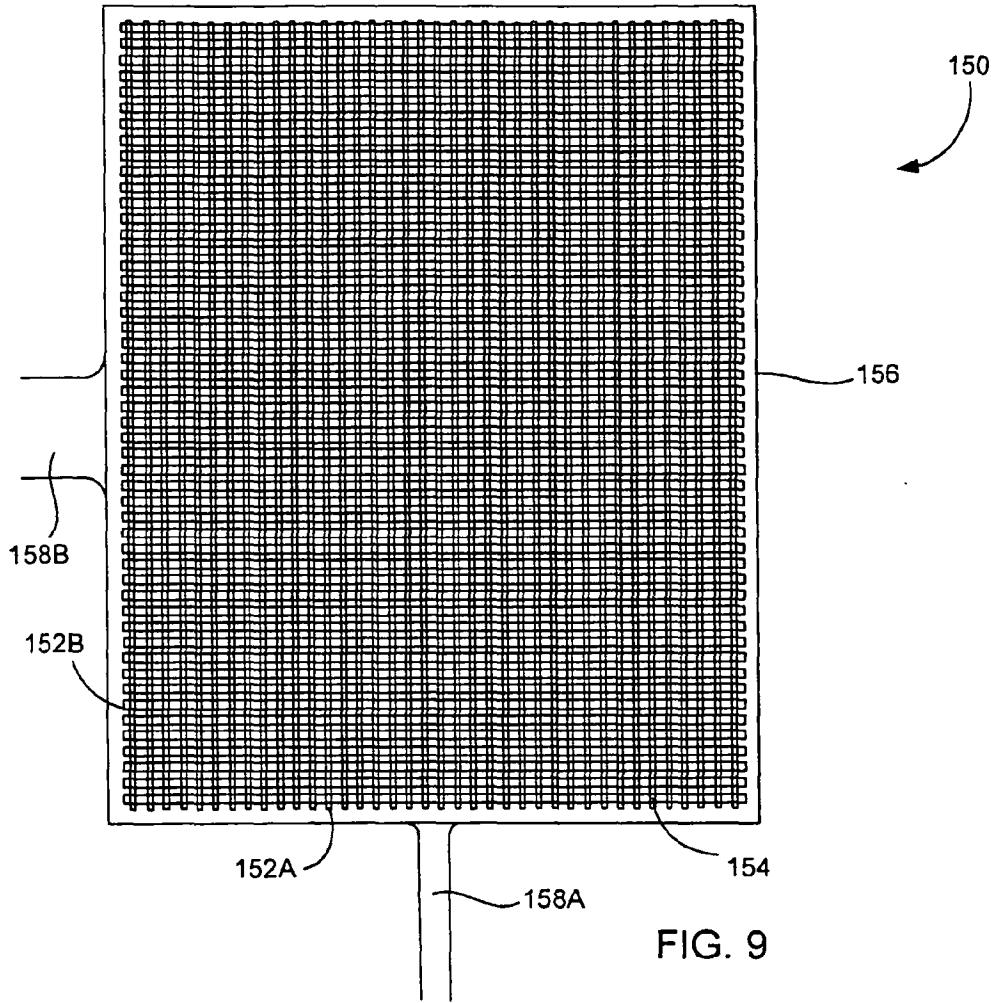

FIG. 9

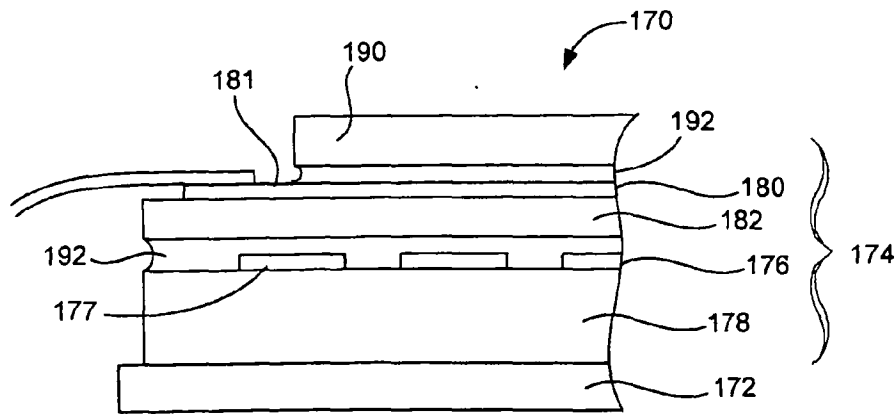

FIG. 10

U.S. Patent

Feb. 16, 2010

Sheet 8 of 14

US 7,663,607 B2

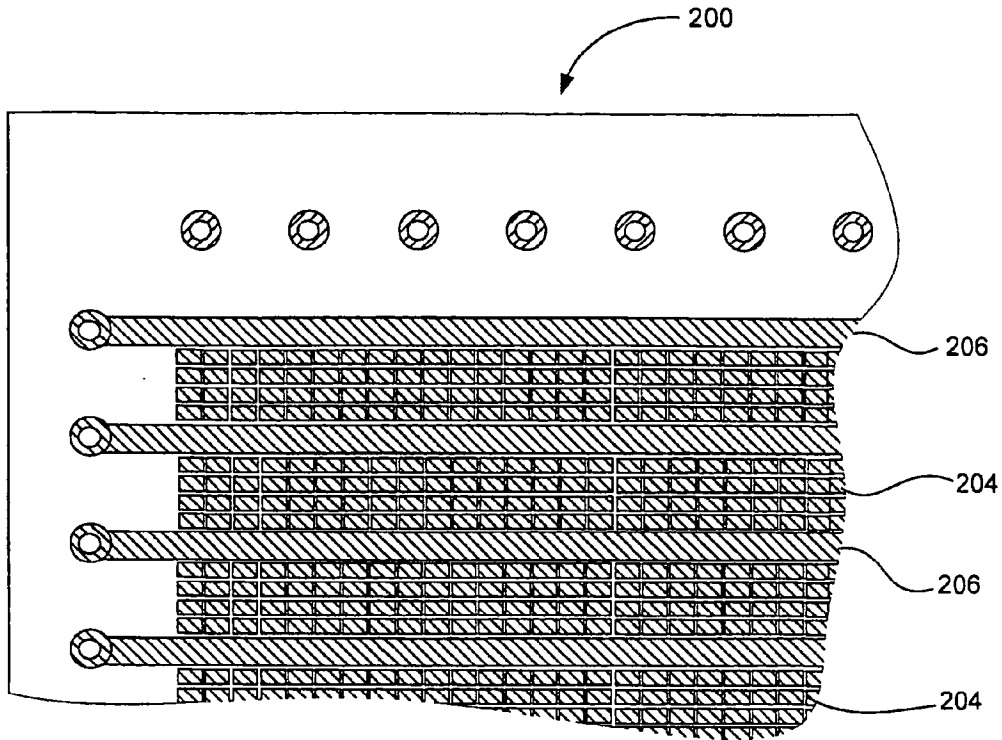

FIG. 11A

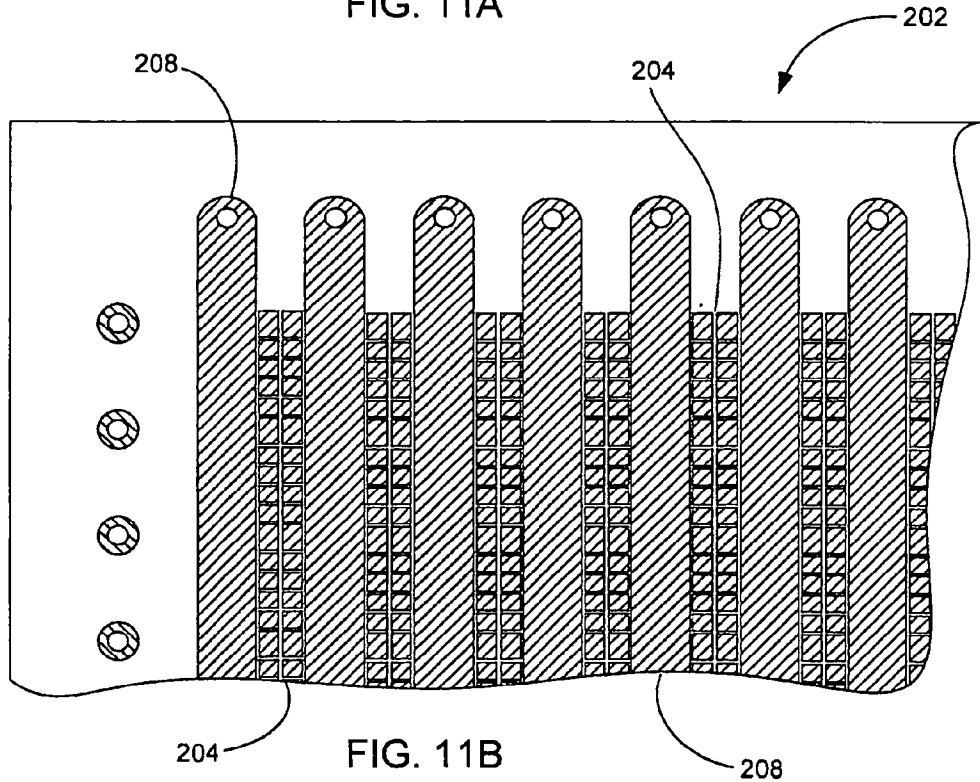

FIG. 11B

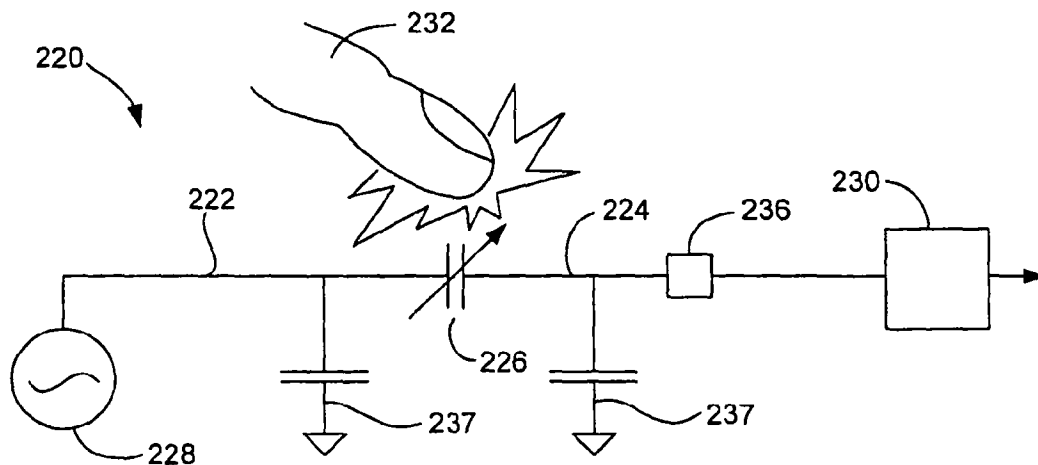

FIG. 12

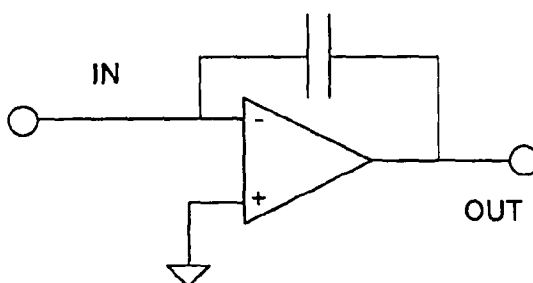

FIG. 13

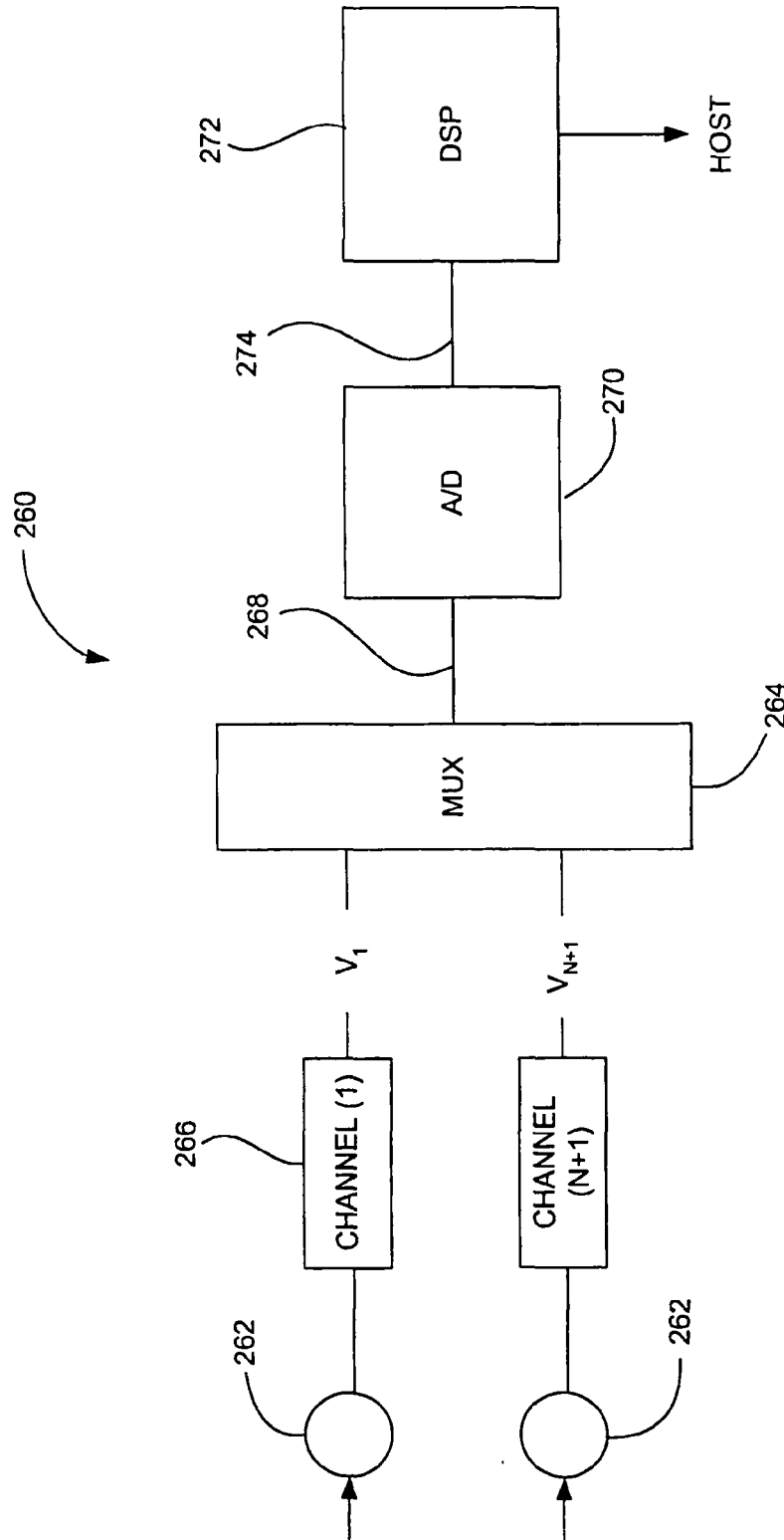

FIG. 14

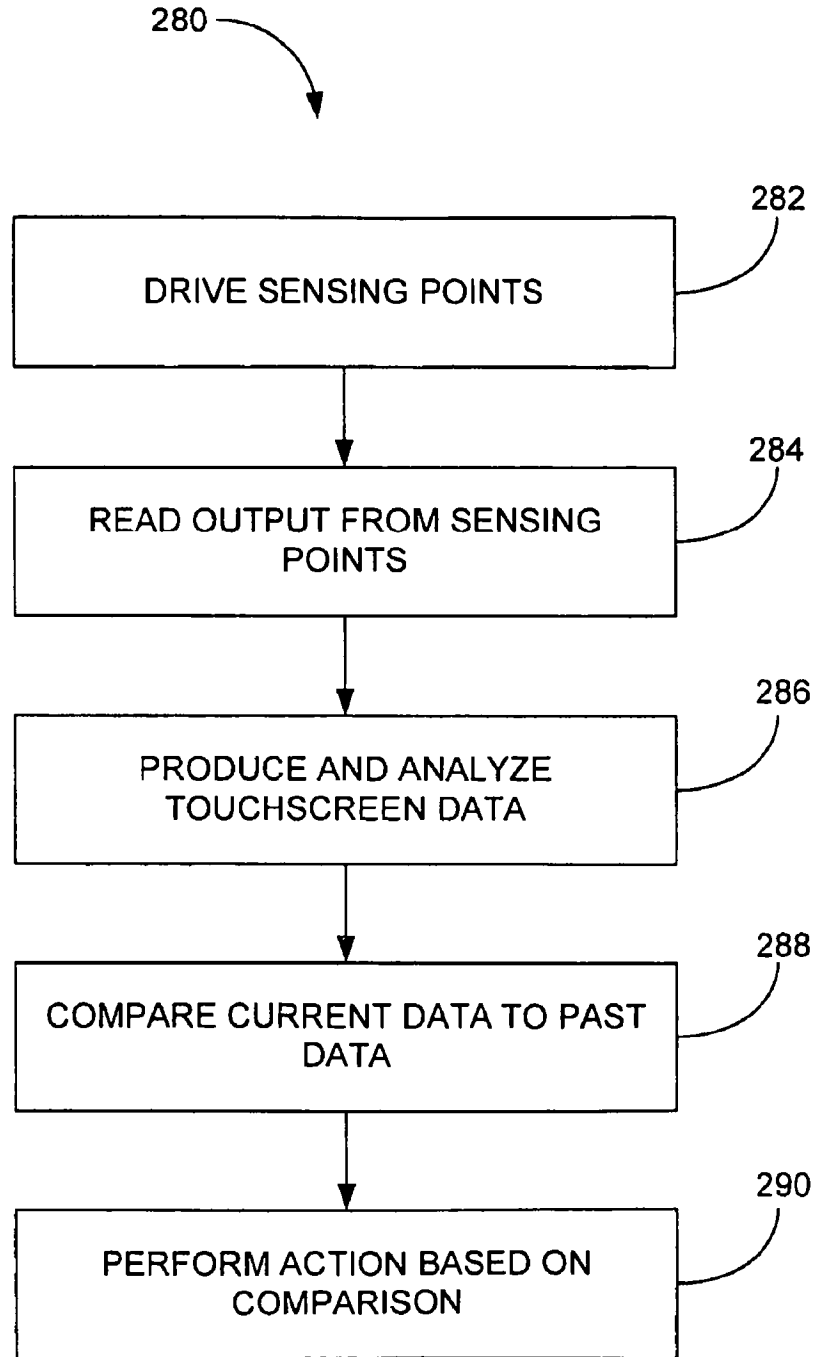

FIG. 15

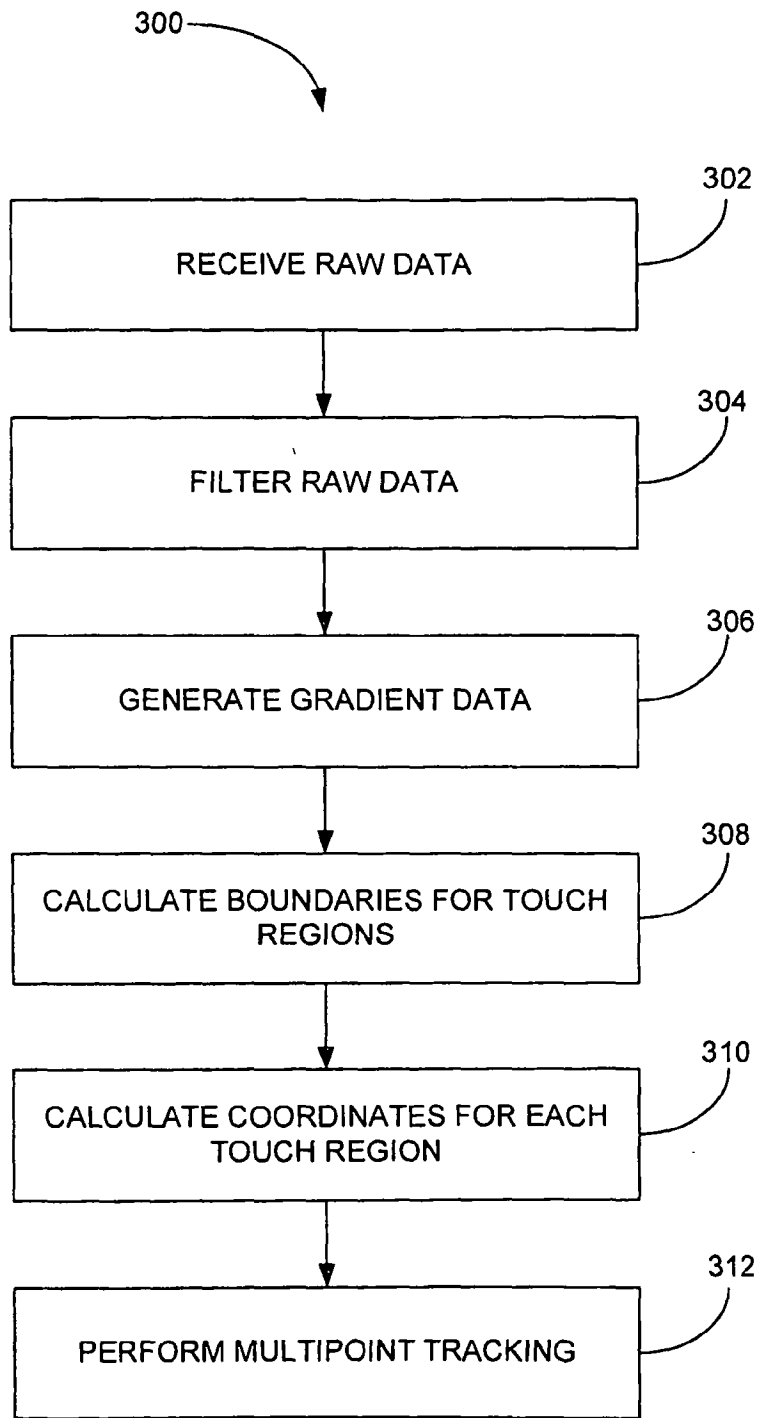

FIG. 16

RAW DATA INCLUDING NOISE

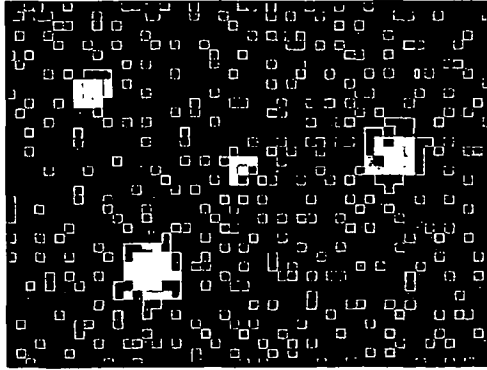

FIG. 17A

FILTERED DATA

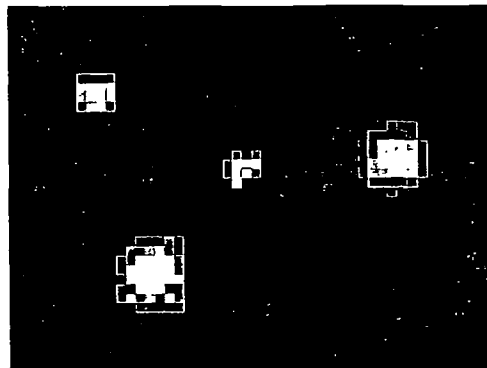

FIG. 17B

GRADIENT DATA

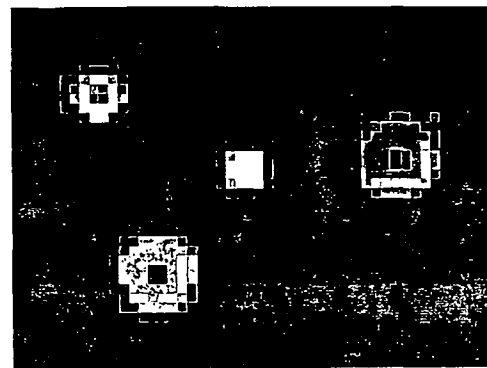

FIG. 17C

TOUCH REGIONS

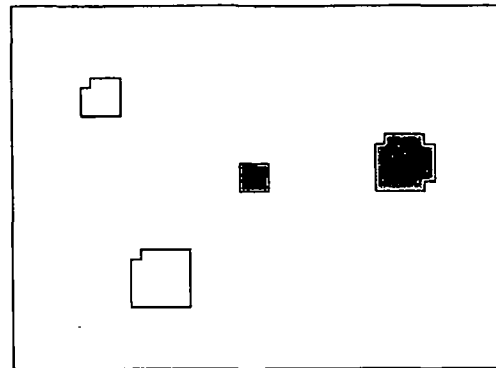

FIG. 17D

COORDINATES OF TOUCH REGIONS

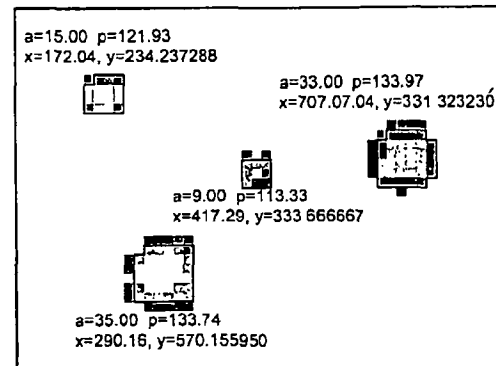

FIG. 17E

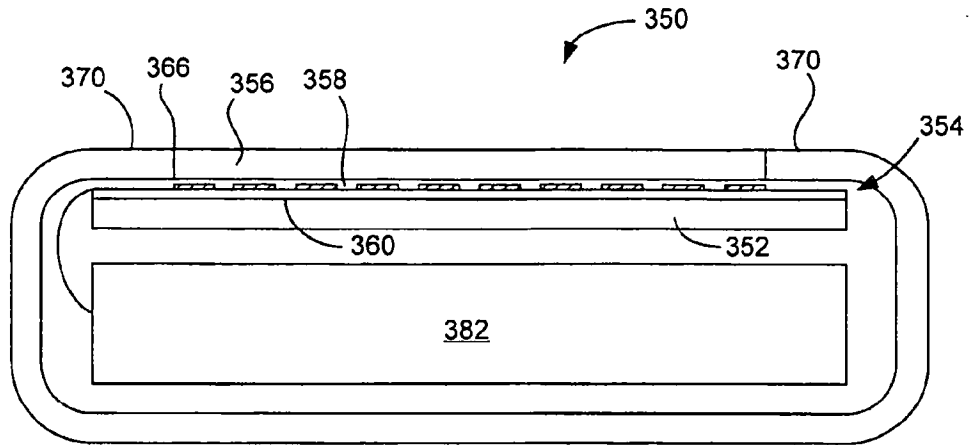

FIG. 18

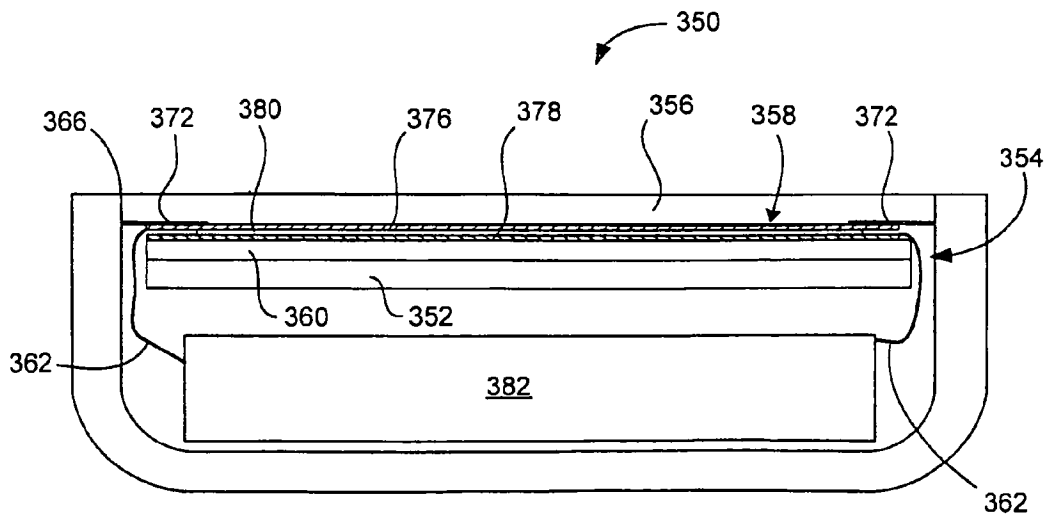

FIG. 19

US 7,663,607 B2

1

MULTIPOINT TOUCHSCREEN

BACKGROUND OF THE INVENTION

1. Field of the Invention

The present invention relates generally to an electronic device having a touch screen. More particularly, the present invention relates to a touch screen capable of sensing multiple points at the same time.

2. Description of the Related Art

There exist today many styles of input devices for performing operations in a computer system. The operations generally correspond to moving a cursor and/or making selections on a display screen. By way of example, the input devices may include buttons or keys, mice, trackballs, touch pads, joy sticks, touch screens and the like. Touch screens, in particular, are becoming increasingly popular because of their ease and versatility of operation as well as to their declining price. Touch screens allow a user to make selections and move a cursor by simply touching the display screen via a finger or stylus. In general, the touch screen recognizes the touch and position of the touch on the display screen and the computer system interprets the touch and thereafter performs an action based on the touch event.

Touch screens typically include a touch panel, a controller and a software driver. The touch panel is a clear panel with a touch sensitive surface. The touch panel is positioned in front of a display screen so that the touch sensitive surface covers the viewable area of the display screen. The touch panel registers touch events and sends these signals to the controller. The controller processes these signals and sends the data to the computer system. The software driver translates the touch events into computer events.

There are several types of touch screen technologies including resistive, capacitive, infrared, surface acoustic wave, electromagnetic, near field imaging, etc. Each of these devices has advantages and disadvantages that are taken into account when designing or configuring a touch screen. In resistive technologies, the touch panel is coated with a thin metallic electrically conductive and resistive layer. When the panel is touched, the layers come into contact thereby closing a switch that registers the position of the touch event. This information is sent to the controller for further processing. In capacitive technologies, the touch panel is coated with a material that stores electrical charge. When the panel is touched, a small amount of charge is drawn to the point of contact. Circuits located at each corner of the panel measure the charge and send the information to the controller for processing.

In surface acoustic wave technologies, ultrasonic waves are sent horizontally and vertically over the touch screen panel as for example by transducers. When the panel is touched, the acoustic energy of the waves are absorbed. Sensors located across from the transducers detect this change and send the information to the controller for processing. In infrared technologies, light beams are sent horizontally and vertically over the touch panel as for example by light emitting diodes. When the panel is touched, some of the light beams emanating from the light emitting diodes are interrupted. Light detectors located across from the light emitting diodes detect this change and send this information to the controller for processing.

One problem found in all of these technologies is that they are only capable of reporting a single point even when multiple objects are placed on the sensing surface. That is, they lack the ability to track multiple points of contact simultaneously. In resistive and capacitive technologies, an average

2

of all simultaneously occurring touch points are determined and a single point which falls somewhere between the touch points is reported. In surface wave and infrared technologies, it is impossible to discern the exact position of multiple touch points that fall on the same horizontal or vertical lines due to masking. In either case, faulty results are generated.

These problems are particularly problematic in tablet PCs where one hand is used to hold the tablet and the other is used to generate touch events. For example, as shown in FIGS. 1A and 1B, holding a tablet 2 causes the thumb 3 to overlap the edge of the touch sensitive surface 4 of the touch screen 5. As shown in FIG. 1A, if the touch technology uses averaging, the technique used by resistive and capacitive panels, then a single point that falls somewhere between the thumb 3 of the left hand and the index finger 6 of the right hand would be reported. As shown in FIG. 1B, if the technology uses projection scanning, the technique used by infra red and SAW panels, it is hard to discern the exact vertical position of the index finger 6 due to the large vertical component of the thumb 3. The tablet 2 can only resolve the patches shown in gray. In essence, the thumb 3 masks out the vertical position of the index finger 6.

SUMMARY OF THE INVENTION

The invention relates, in one embodiment, to a touch panel having a transparent capacitive sensing medium configured to detect multiple touches or near touches that occur at the same time and at distinct locations in the plane of the touch panel and to produce distinct signals representative of the location of the touches on the plane of the touch panel for each of the multiple touches.

The invention relates, in another embodiment, to a display arrangement. The display arrangement includes a display having a screen for displaying a graphical user interface. The display arrangement further includes a transparent touch panel allowing the screen to be viewed therethrough and capable of recognizing multiple touch events that occur at different locations on the touch sensitive surface of the touch screen at the same time and to output this information to a host device.

The invention relates, in another embodiment, to a computer implemented method. The method includes receiving multiple touches on the surface of a transparent touch screen at the same time. The method also includes separately recognizing each of the multiple touches. The method further includes reporting touch data based on the recognized multiple touches.

The invention relates, in another embodiment, to a computer system. The computer system includes a processor configured to execute instructions and to carry out operations associated with the computer system. The computer also includes a display device that is operatively coupled to the processor. The computer system further includes a touch screen that is operatively coupled to the processor. The touch screen is a substantially transparent panel that is positioned in front of the display. The touch screen is configured to track multiple objects, which rest on, tap on or move across the touch screen at the same time. The touch screen includes a capacitive sensing device that is divided into several independent and spatially distinct sensing points that are positioned throughout the plane of the touch screen. Each sensing point is capable of generating a signal at the same time. The touch screen also includes a sensing circuit that acquires data from the sensing device and that supplies the acquired data to the processor.

US 7,663,607 B2

3

The invention relates, in another embodiment, to a touch screen method. The method includes driving a plurality of sensing points. The method also includes reading the outputs from all the sensing lines connected to the sensing points. The method further includes producing and analyzing an image of the touch screen plane at one moment in time in order to determine where objects are touching the touch screen. The method additionally includes comparing the current image to a past image in order to determine a change at the objects touching the touch screen.

The invention relates, in another embodiment, to a digital signal processing method. The method includes receiving raw data. The raw data includes values for each transparent capacitive sensing node of a touch screen. The method also includes filtering the raw data. The method further includes generating gradient data. The method additionally includes calculating the boundaries for touch regions base on the gradient data. Moreover, the method includes calculating the coordinates for each touch region.

BRIEF DESCRIPTION OF THE DRAWINGS

The invention will be readily understood by the following detailed description in conjunction with the accompanying drawings, wherein like reference numerals designate like structural elements, and in which:

FIGS. 1A and 1B show a user holding conventional touch screens.

FIG. 2 is a perspective view of a display arrangement, in accordance with one embodiment of the present invention.

FIG. 3 shows an image of the touch screen plane at a particular point in time, in accordance with one embodiment of the present invention.

FIG. 4 is a multipoint touch method, in accordance with one embodiment of the present invention.

FIG. 5 is a block diagram of a computer system, in accordance with one embodiment of the present invention.

FIG. 6 is a partial top view of a transparent multiple point touch screen, in accordance with one embodiment of the present invention.

FIG. 7 is a partial top view of a transparent multi point touch screen, in accordance with one embodiment of the present invention.

FIG. 8 is a front elevation view, in cross section of a display arrangement, in accordance with one embodiment of the present invention.

FIG. 9 is a top view of a transparent multipoint touch screen, in accordance with another embodiment of the present invention.

FIG. 10 is a partial front elevation view, in cross section of a display arrangement, in accordance with one embodiment of the present invention.

FIGS. 11A and 11B are partial top view diagrams of a driving layer and a sensing layer, in accordance with one embodiment.

FIG. 12 is a simplified diagram of a mutual capacitance circuit, in accordance with one embodiment of the present invention.

FIG. 13 is a diagram of a charge amplifier, in accordance with one embodiment of the present invention.

FIG. 14 is a block diagram of a capacitive sensing circuit, in accordance with one embodiment of the present invention.

FIG. 15 is a flow diagram, in accordance with one embodiment of the present invention.

FIG. 16 is a flow diagram of a digital signal processing method, in accordance with one embodiment of the present invention.

4

FIGS. 17A-E show touch data at several steps, in accordance with one embodiment of the present invention

FIG. 18 is a side elevation view of an electronic device, in accordance with one embodiments of the present invention.

FIG. 19 is a side elevation view of an electronic device, in accordance with one embodiments of the present invention.

DETAILED DESCRIPTION OF THE INVENTION

Embodiments of the invention are discussed below with reference to FIGS. 2-19. However, those skilled in the art will readily appreciate that the detailed description given herein with respect to these figures is for explanatory purposes as the invention extends beyond these limited embodiments.

FIG. 2 is a perspective view of a display arrangement 30, in accordance with one embodiment of the present invention. The display arrangement 30 includes a display 34 and a transparent touch screen 36 positioned in front of the display 34. The display 34 is configured to display a graphical user interface (GUI) including perhaps a pointer or cursor as well as other information to the user. The transparent touch screen 36, on the other hand, is an input device that is sensitive to a user's touch, allowing a user to interact with the graphical user interface on the display 34. By way of example, the touch screen 36 may allow a user to move an input pointer or make selections on the graphical user interface by simply pointing at the GUI on the display 34.

In general, touch screens 36 recognize a touch event on the surface 38 of the touch screen 36 and thereafter output this information to a host device. The host device may for example correspond to a computer such as a desktop, laptop, handheld or tablet computer. The host device interprets the touch event and thereafter performs an action based on the touch event. Conventionally, touch screens have only been capable of recognizing a single touch event even when the touch screen is touched at multiple points at the same time (e.g., averaging, masking, etc.). Unlike conventional touch screens, however, the touch screen 36 shown herein is configured to recognize multiple touch events that occur at different locations on the touch sensitive surface 38 of the touch screen 36 at the same time. That is, the touch screen 36 allows for multiple contact points T1-T4 to be tracked simultaneously, i.e., if four objects are touching the touch screen, then the touch screen tracks all four objects. As shown, the touch screen 36 generates separate tracking signals S1-S4 for each touch point T1-T4 that occurs on the surface of the touch screen 36 at the same time. The number of recognizable touches may be about 15. 15 touch points allows for all 10 fingers, two palms and 3 others.

The multiple touch events can be used separately or together to perform singular or multiple actions in the host device. When used separately, a first touch event may be used to perform a first action while a second touch event may be used to perform a second action that is different than the first action. The actions may for example include moving an object such as a cursor or pointer, scrolling or panning, adjusting control settings, opening a file or document, viewing a menu, making a selection, executing instructions, operating a peripheral device connected to the host device etc. When used together, first and second touch events may be used for performing one particular action. The particular action may for example include logging onto a computer or a computer network, permitting authorized individuals access to restricted areas of the computer or computer network, loading a user profile associated with a user's preferred arrangement of the computer desktop, permitting access to web content, launching a particular program, encrypting or decoding a message, and/or the like.

US 7,663,607 B2

5

Recognizing multiple touch events is generally accomplished with a multipoint sensing arrangement. The multipoint sensing arrangement is capable of simultaneously detecting and monitoring touches and the magnitude of those touches at distinct points across the touch sensitive surface 38 of the touch screen 36. The multipoint sensing arrangement generally provides a plurality of transparent sensor coordinates or nodes 42 that work independent of one another and that represent different points on the touch screen 36. When plural objects are pressed against the touch screen 36, one or more sensor coordinates are activated for each touch point as for example touch points T1-T4. The sensor coordinates 42 associated with each touch point T1-T4 produce the tracking signals S1-S4.

In one embodiment, the touch screen 36 includes a plurality of capacitance sensing nodes 42. The capacitive sensing nodes may be widely varied. For example, the capacitive sensing nodes may be based on self capacitance or mutual capacitance. In self capacitance, the "self" capacitance of a single electrode is measured as for example relative to ground. In mutual capacitance, the mutual capacitance between at least first and second electrodes is measured. In either cases, each of the nodes 42 works independent of the other nodes 42 so as to produce simultaneously occurring signals representative of different points on the touch screen 36.

In order to produce a transparent touch screen 36, the capacitance sensing nodes 42 are formed with a transparent conductive medium such as indium tin oxide (ITO). In self capacitance sensing arrangements, the transparent conductive medium is patterned into spatially separated electrodes and traces. Each of the electrodes represents a different coordinate and the traces connect the electrodes to a capacitive sensing circuit. The coordinates may be associated with Cartesian coordinate system (x and y), Polar coordinate system (r, θ) or some other coordinate system. In a Cartesian coordinate system, the electrodes may be positioned in columns and rows so as to form a grid array with each electrode representing a different x, y coordinate. During operation, the capacitive sensing circuit monitors changes in capacitance that occur at each of the electrodes. The positions where changes occur and the magnitude of those changes are used to help recognize the multiple touch events. A change in capacitance typically occurs at an electrode when a user places an object such as a finger in close proximity to the electrode, i.e., the object steals charge thereby affecting the capacitance.

In mutual capacitance, the transparent conductive medium is patterned into a group of spatially separated lines formed on two different layers. Driving lines are formed on a first layer and sensing lines are formed on a second layer. Although separated by being on different layers, the sensing lines traverse, intersect or cut across the driving lines thereby forming a capacitive coupling node. The manner in which the sensing lines cut across the driving lines generally depends on the coordinate system used. For example, in a Cartesian coordinate system, the sensing lines are perpendicular to the driving lines thereby forming nodes with distinct x and y coordinates. Alternatively, in a polar coordinate system, the sensing lines may be concentric circles and the driving lines may be radially extending lines (or vice versa). The driving lines are connected to a voltage source and the sensing lines are connected to capacitive sensing circuit. During operation, a current is driven through one driving line at a time, and because of capacitive coupling, the current is carried through to the sensing lines at each of the nodes (e.g., intersection points). Furthermore, the sensing circuit monitors changes in capacitance that occurs at each of the nodes. The positions where

6

changes occur and the magnitude of those changes are used to help recognize the multiple touch events. A change in capacitance typically occurs at a capacitive coupling node when a user places an object such as a finger in close proximity to the capacitive coupling node, i.e., the object steals charge thereby affecting the capacitance.

By way of example, the signals generated at the nodes 42 of the touch screen 36 may be used to produce an image of the touch screen plane at a particular point in time. Referring to FIG. 3, each object in contact with a touch sensitive surface 38 of the touch screen 36 produces a contact patch area 44. Each of the contact patch areas 44 covers several nodes 42. The covered nodes 42 detect surface contact while the remaining nodes 42 do not detect surface contact. As a result, a pixilated image of the touch screen plane can be formed. The signals for each contact patch area 44 may be grouped together to form individual images representative of the contact patch area 44. The image of each contact patch area 44 may include high and low points based on the pressure at each point. The shape of the image as well as the high and low points within the image may be used to differentiate contact patch areas 44 that are in close proximity to one another. Furthermore, the current image, and more particularly the image of each contact patch area 44 can be compared to previous images to determine what action to perform in a host device.

Referring back to FIG. 2, the display arrangement 30 may be a stand alone unit or it may be integrated with other devices. When stand alone, the display arrangement 32 (or each of its components) acts like a peripheral device (monitor) that includes its own housing and that can be coupled to a host device through wired or wireless connections. When integrated, the display arrangement 30 shares a housing and is hard wired into the host device thereby forming a single unit. By way of example, the display arrangement 30 may be disposed inside a variety of host devices including but not limited to general purpose computers such as a desktop, laptop or tablet computers, handhelds such as PDAs and media players such as music players, or peripheral devices such as cameras, printers and/or the like.

FIG. 4 is a multipoint touch method 45, in accordance with one embodiment of the present invention. The method generally begins at block 46 where multiple touches are received on the surface of the touch screen at the same time. This may for example be accomplished by placing multiple fingers on the surface of the touch screen. Following block 46, the process flow proceeds to block 47 where each of the multiple touches is separately recognized by the touch screen. This may for example be accomplished by multipoint capacitance sensors located within the touch screen. Following block 47, the process flow proceeds to block 48 where the touch data based on multiple touches is reported. The touch data may for example be reported to a host device such as a general purpose computer.

FIG. 5 is a block diagram of a computer system 50, in accordance with one embodiment of the present invention. The computer system 50 may correspond to personal computer systems such as desktops, laptops, tablets or handhelds. By way of example, the computer system may correspond to any Apple or PC based computer system. The computer system may also correspond to public computer systems such as information kiosks, automated teller machines (ATM), point of sale machines (POS), industrial machines, gaming machines, arcade machines, vending machines, airline e-ticket terminals, restaurant reservation terminals, customer service stations, library terminals, learning devices, and the like.

US 7,663,607 B2

7

As shown, the computer system 50 includes a processor 56 configured to execute instructions and to carry out operations associated with the computer system 50. For example, using instructions retrieved for example from memory, the processor 56 may control the reception and manipulation of input and output data between components of the computing system 50. The processor 56 can be a single-chip processor or can be implemented with multiple components.

In most cases, the processor 56 together with an operating system operates to execute computer code and produce and use data. The computer code and data may reside within a program storage block 58 that is operatively coupled to the processor 56. Program storage block 58 generally provides a place to hold data that is being used by the computer system 50. By way of example, the program storage block may include Read-Only Memory (ROM) 60, Random-Access Memory (RAM) 62, hard disk drive 64 and/or the like. The computer code and data could also reside on a removable storage medium and loaded or installed onto the computer system when needed. Removable storage mediums include, for example, CD-ROM, PC-CARD, floppy disk, magnetic tape, and a network component.

The computer system 50 also includes an input/output (I/O) controller 66 that is operatively coupled to the processor 56. The I/O controller 66 may be integrated with the processor 56 or it may be a separate component as shown. The I/O controller 66 is generally configured to control interactions with one or more I/O devices. The I/O controller 66 generally operates by exchanging data between the processor and the I/O devices that desire to communicate with the processor. The I/O devices and the I/O controller typically communicate through a data link 67. The data link 67 may be a one way link or two way link. In some cases, the I/O devices may be connected to the I/O controller 66 through wired connections. In other cases, the I/O devices may be connected to the I/O controller 66 through wireless connections. By way of example, the data link 67 may correspond to PS/2, USB, Firewire, IR, RF, Bluetooth or the like.

The computer system 50 also includes a display device 68 that is operatively coupled to the processor 56. The display device 68 may be a separate component (peripheral device) or it may be integrated with the processor and program storage to form a desktop computer (all in one machine), a laptop, handheld or tablet or the like. The display device 68 is configured to display a graphical user interface (GUI) including perhaps a pointer or cursor as well as other information to the user. By way of example, the display device 68 may be a monochrome display, color graphics adapter (CGA) display, enhanced graphics adapter (EGA) display, variable-graphics-array (VGA) display, super VGA display, liquid crystal display (e.g., active matrix, passive matrix and the like), cathode ray tube (CRT), plasma displays and the like.

The computer system 50 also includes a touch screen 70 that is operatively coupled to the processor 56. The touch screen 70 is a transparent panel that is positioned in front of the display device 68. The touch screen 70 may be integrated with the display device 68 or it may be a separate component. The touch screen 70 is configured to receive input from a user's touch and to send this information to the processor 56. In most cases, the touch screen 70 recognizes touches and the position and magnitude of touches on its surface. The touch screen 70 reports the touches to the processor 56 and the processor 56 interprets the touches in accordance with its programming. For example, the processor 56 may initiate a task in accordance with a particular touch.

In accordance with one embodiment, the touch screen 70 is capable of tracking multiple objects, which rest on, tap on, or

8

move across the touch sensitive surface of the touch screen at the same time. The multiple objects may for example correspond to fingers and palms. Because the touch screen is capable of tracking multiple objects, a user may perform several touch initiated tasks at the same time. For example, the user may select an onscreen button with one finger, while moving a cursor with another finger. In addition, a user may move a scroll bar with one finger while selecting an item from a menu with another finger. Furthermore, a first object may be dragged with one finger while a second object may be dragged with another finger. Moreover, gesturing may be performed with more than one finger.

To elaborate, the touch screen 70 generally includes a sensing device 72 configured to detect an object in close proximity thereto and/or the pressure exerted thereon. The sensing device 72 may be widely varied. In one particular embodiment, the sensing device 72 is divided into several independent and spatially distinct sensing points, nodes or regions 74 that are positioned throughout the touch screen 70. The sensing points 74, which are typically hidden from view, are dispersed about the touch screen 70 with each sensing point 74 representing a different position on the surface of the touch screen 70 (or touch screen plane). The sensing points 74 may be positioned in a grid or a pixel array where each pixelated sensing point 74 is capable of generating a signal at the same time. In the simplest case, a signal is produced each time an object is positioned over a sensing point 74. When an object is placed over multiple sensing points 74 or when the object is moved between or over multiple sensing point 74, multiple signals are generated.

The number and configuration of the sensing points 74 may be widely varied. The number of sensing points 74 generally depends on the desired sensitivity as well as the desired transparency of the touch screen 70. More nodes or sensing points generally increases sensitivity, but reduces transparency (and vice versa). With regards to configuration, the sensing points 74 generally map the touch screen plane into a coordinate system such as a Cartesian coordinate system, a Polar coordinate system or some other coordinate system. When a Cartesian coordinate system is used (as shown), the sensing points 74 typically correspond to x and y coordinates. When a Polar coordinate system is used, the sensing points typically correspond to radial (r) and angular coordinates (θ).

The touch screen 70 may include a sensing circuit 76 that acquires the data from the sensing device 72 and that supplies the acquired data to the processor 56. Alternatively, the processor may include this functionality. In one embodiment, the sensing circuit 76 is configured to send raw data to the processor 56 so that the processor 56 processes the raw data. For example, the processor 56 receives data from the sensing circuit 76 and then determines how the data is to be used within the computer system 50. The data may include the coordinates of each sensing point 74 as well as the pressure exerted on each sensing point 74. In another embodiment, the sensing circuit 76 is configured to process the raw data itself. That is, the sensing circuit 76 reads the pulses from the sensing points 74 and turns them into data that the processor 56 can understand. The sensing circuit 76 may perform filtering and/or conversion processes. Filtering processes are typically implemented to reduce a busy data stream so that the processor 56 is not overloaded with redundant or non-essential data. The conversion processes may be implemented to adjust the raw data before sending or reporting them to the processor 56. The conversions may include determining the center point for each touch region (e.g., centroid).

The sensing circuit 76 may include a storage element for storing a touch screen program, which is a capable of con-

US 7,663,607 B2

9

trolling different aspects of the touch screen 70. For example, the touch screen program may contain what type of value to output based on the sensing points 74 selected (e.g., coordinates). In fact, the sensing circuit in conjunction with the touch screen program may follow a predetermined communication protocol. As is generally well known, communication protocols are a set of rules and procedures for exchanging data between two devices. Communication protocols typically transmit information in data blocks or packets that contain the data to be transmitted, the data required to direct the packet to its destination, and the data that corrects errors that occur along the way. By way of example, the sensing circuit may place the data in a HID format (Human Interface Device).

The sensing circuit 76 generally includes one or more microcontrollers, each of which monitors one or more sensing points 74. The microcontrollers may for example correspond to an application specific integrated circuit (ASIC), which works with firmware to monitor the signals from the sensing device 72 and to process the monitored signals and to report this information to the processor 56.

In accordance with one embodiment, the sensing device 72 is based on capacitance. As should be appreciated, whenever two electrically conductive members come close to one another without actually touching, their electric fields interact to form capacitance. In most cases, the first electrically conductive member is a sensing point 74 and the second electrically conductive member is an object 80 such as a finger. As the object 80 approaches the surface of the touch screen 70, a tiny capacitance forms between the object 80 and the sensing points 74 in close proximity to the object 80. By detecting changes in capacitance at each of the sensing points 74 and noting the position of the sensing points, the sensing circuit can recognize multiple objects, and determine the location, pressure, direction, speed and acceleration of the objects 80 as they are moved across the touch screen 70. For example, the sensing circuit can determine when and where each of the fingers and palm of one or more hands are touching as well as the pressure being exerted by the finger and palm of the hand(s) at the same time.

The simplicity of capacitance allows for a great deal of flexibility in design and construction of the sensing device 72. By way of example, the sensing device 72 may be based on self capacitance or mutual capacitance. In self capacitance, each of the sensing points 74 is provided by an individual charged electrode. As an object approaches the surface of the touch screen 70, the object capacitively couples to those electrodes in close proximity to the object thereby stealing charge away from the electrodes. The amount of charge in each of the electrodes are measured by the sensing circuit 76 to determine the positions of multiple objects when they touch the touch screen 70. In mutual capacitance, the sensing device 72 includes a two layer grid of spatially separated lines or wires. In the simplest case, the upper layer includes lines in rows while the lower layer includes lines in columns (e.g., orthogonal). The sensing points 74 are provided at the intersections of the rows and columns. During operation, the rows are charged and the charge capacitively couples to the columns at the intersection. As an object approaches the surface of the touch screen, the object capacitively couples to the rows at the intersections in close proximity to the object thereby stealing charge away from the rows and therefore the columns as well. The amount of charge in each of the columns is measured by the sensing circuit 76 to determine the positions of multiple objects when they touch the touch screen 70.

FIG. 6 is a partial top view of a transparent multiple point touch screen 100, in accordance with one embodiment of the

10

present invention. By way of example, the touch screen 100 may generally correspond to the touch screen shown in FIGS. 2 and 4. The multipoint touch screen 100 is capable of sensing the position and the pressure of multiple objects at the same time. This particular touch screen 100 is based on self capacitance and thus it includes a plurality of transparent capacitive sensing electrodes 102, which each represent different coordinates in the plane of the touch screen 100. The electrodes 102 are configured to receive capacitive input from one or more objects touching the touch screen 100 in the vicinity of the electrodes 102. When an object is proximate an electrode 102, the object steals charge thereby affecting the capacitance at the electrode 102. The electrodes 102 are connected to a capacitive sensing circuit 104 through traces 106 that are positioned in the gaps 108 found between the spaced apart electrodes 102. The electrodes 102 are spaced apart in order to electrically isolate them from each other as well as to provide a space for separately routing the sense traces 106. The gap 108 is preferably made small so as to maximize the sensing area and to minimize optical differences between the space and the transparent electrodes.

As shown, the sense traces 106 are routed from each electrode 102 to the sides of the touch screen 100 where they are connected to the capacitive sensing circuit 104. The capacitive sensing circuit 104 includes one or more sensor ICs 110 that measure the capacitance at each electrode 102 and that reports its findings or some form thereof to a host controller. The sensor ICs 110 may for example convert the analog capacitive signals to digital data and thereafter transmit the digital data over a serial bus to a host controller. Any number of sensor ICs may be used. For example, a single chip may be used for all electrodes, or multiple chips may be used for a single or group of electrodes. In most cases, the sensor ICs 110 report tracking signals, which are a function of both the position of the electrode 102 and the intensity of the capacitance at the electrode 102.

The electrodes 102, traces 106 and sensing circuit 104 are generally disposed on an optical transmissive member 112. In most cases, the optically transmissive member 112 is formed from a clear material such as glass or plastic. The electrode 102 and traces 106 may be placed on the member 112 using any suitable patterning technique including for example, deposition, etching, printing and the like. The electrodes 102 and sense traces 106 can be made from any suitable transparent conductive material. By way of example, the electrodes 102 and traces 106 may be formed from indium tin oxide (ITO). In addition, the sensor ICs 110 of the sensing circuit 104 can be electrically coupled to the traces 106 using any suitable techniques. In one implementation, the sensor ICs 110 are placed directly on the member 112 (flip chip). In another implementation, a flex circuit is bonded to the member 112, and the sensor ICs 110 are attached to the flex circuit. In yet another implementation, a PCB is bonded to the member 112, a PCB is bonded to the flex circuit and the sensor ICs 110 are attached to the PCB. The sensor ICs may for example be capacitance sensing ICs such as those manufactured by Synaptics of San Jose, Calif., Fingerworks of Newark, Del. or Alps of San Jose, Calif.

The distribution of the electrodes 102 may be widely varied. For example, the electrodes 102 may be positioned almost anywhere in the plane of the touch screen 100. The electrodes 102 may be positioned randomly or in a particular pattern about the touch screen 100. With regards to the later, the position of the electrodes 102 may depend on the coordinate system used. For example, the electrodes 102 may be placed in an array of rows and columns for Cartesian coordinates or an array of concentric and radial segments for polar

US 7,663,607 B2

11

coordinates. Within each array, the rows, columns, concentric or radial segments may be stacked uniformly relative to the others or they may be staggered or offset relative to the others. Additionally, within each row or column, or within each concentric or radial segment, the electrodes 102 may be staggered or offset relative to an adjacent electrode 102.

Furthermore, the electrodes 102 may be formed from almost any shape whether simple (e.g., squares, circles, ovals, triangles, rectangles, polygons, and the like) or complex (e.g., random shapes). Further still, the shape of the electrodes 102 may have identical shapes or they may have different shapes. For example, one set of electrodes 102 may have a first shape while a second set of electrodes 102 may have a second shape that is different than the first shape. The shapes are generally chosen to maximize the sensing area and to minimize optical differences between the gaps and the transparent electrodes.

In addition, the size of the electrodes 102 may vary according to the specific needs of each device. In some cases, the size of the electrodes 102 corresponds to about the size of a finger tip. For example, the size of the electrodes 102 may be on the order of 4-5 mm². In other cases, the size of the electrodes 102 are smaller than the size of the finger tip so as to improve resolution of the touch screen 100 (the finger can influence two or more electrodes at any one time thereby enabling interpolation). Like the shapes, the size of the electrodes 102 may be identical or they may be different. For example, one set of electrodes 102 may be larger than another set of electrodes 102. Moreover, any number of electrodes 102 may be used. The number of electrodes 102 is typically determined by the size of the touch screen 100 as well as the size of each electrode 102. In most cases, it would be desirable to increase the number of electrodes 102 so as to provide higher resolution, i.e., more information can be used for such things as acceleration.

Although the sense traces 106 can be routed a variety of ways, they are typically routed in manner that reduces the distance they have to travel between their electrode 102 and the sensor circuit 104, and that reduces the size of the gaps 108 found between adjacent electrodes 102. The width of the sense traces 106 are also widely varied. The widths are generally determined by the amount of charge being distributed there through, the number of adjacent traces 106, and the size of the gap 108 through which they travel. It is generally desirable to maximize the widths of adjacent traces 106 in order to maximize the coverage inside the gaps 108 thereby creating a more uniform optical appearance.

In the illustrated embodiment, the electrodes 102 are positioned in a pixilated array. As shown, the electrodes 102 are positioned in rows 116 that extend to and from the sides of the touch screen 100. Within each row 116, the identical electrodes 102 are spaced apart and positioned laterally relative to one another (e.g., juxtaposed). Furthermore, the rows 116 are stacked on top of each other thereby forming the pixilated array. The sense traces 106 are routed in the gaps 108 formed between adjacent rows 106. The sense traces 106 for each row are routed in two different directions. The sense traces 106 on one side of the row 116 are routed to a sensor IC 110 located on the left side and the sense traces 106 on the other side of the row 116 are routed to another sensor IC 110 located on the right side of the touch screen 100. This is done to minimize the gap 108 formed between rows 116. The gap 108 may for example be held to about 20 microns. As should be appreciated, the spaces between the traces can stack thereby creating a large gap between electrodes. If routed to one side, the size of the space would be substantially doubled thereby reducing the resolution of the touch screen. Moreover, the shape of the

12

electrode 102 is in the form of a parallelogram, and more particularly a parallelogram with sloping sides.

FIG. 7 is a partial top view of a transparent multi point touch screen 120, in accordance with one embodiment of the present invention. In this embodiment, the touch screen 120 is similar to the touch screen 100 shown in FIG. 6, however, unlike the touch screen 100 of FIG. 6, the touch screen 120 shown in FIG. 7 includes electrodes 122 with different sizes. As shown, the electrodes 122 located in the center of the touch screen 120 are larger than the electrodes 122 located at the sides of the touch screen 120. In fact, the height of the electrodes 122 gets correspondingly smaller when moving from the center to the edge of the touch screen 120. This is done to make room for the sense traces 124 extending from the sides of the more centrally located electrodes 122. This arrangement advantageously reduces the gap found between adjacent rows 126 of electrodes 122. Although the height of each electrode 122 shrinks, the height H of the row 126 as well as the width W of each electrode 122 stays the same. In one configuration, the height of the row 126 is substantially equal to the width of each electrode 122. For example, the height of the row 126 and the width of each electrode 122 may be about 4 mm to about 5 mm.

FIG. 8 is a front elevation view, in cross section of a display arrangement 130, in accordance with one embodiment of the present invention. The display arrangement 130 includes an LCD display 132 and a touch screen 134 positioned over the LCD display 132. The touch screen may for example correspond to the touch screen shown in FIG. 6 or 7. The LCD display 132 may correspond to any conventional LCD display known in the art. Although not shown, the LCD display 132 typically includes various layers including a fluorescent panel, polarizing filters, a layer of liquid crystal cells, a color filter and the like.

The touch screen 134 includes a transparent electrode layer 136 that is positioned over a glass member 138. The glass member 138 may be a portion of the LCD display 132 or it may be a portion of the touch screen 134. In either case, the glass member 138 is a relatively thick piece of clear glass that protects the display 132 from forces, which are exerted on the touch screen 134. The thickness of the glass member 138 may for example be about 2 mm. In most cases, the electrode layer 136 is disposed on the glass member 138 using suitable transparent conductive materials and patterning techniques such as ITO and printing. Although not shown, in some cases, it may be necessary to coat the electrode layer 136 with a material of similar refractive index to improve the visual appearance of the touch screen. As should be appreciated, the gaps located between electrodes and traces do not have the same optical index as the electrodes and traces, and therefore a material may be needed to provide a more similar optical index. By way of example, index matching gels may be used.

The touch screen 134 also includes a protective cover sheet 140 disposed over the electrode layer 136. The electrode layer 136 is therefore sandwiched between the glass member 138 and the protective cover sheet 140. The protective sheet 140 serves to protect the under layers and provide a surface for allowing an object to slide thereon. The protective sheet 140 also provides an insulating layer between the object and the electrode layer 136. The protective cover sheet 140 may be formed from any suitable clear material such as glass and plastic. The protective cover sheet 140 is suitably thin to allow for sufficient electrode coupling. By way of example, the thickness of the cover sheet 140 may be between about 0.3-0.8 mm. In addition, the protective cover sheet 140 may be treated with coatings to reduce stiction when touching and reduce glare when viewing the underlying LCD display 132.

US 7,663,607 B2

13

By way of example, a low stiction/anti reflective coating 142 may be applied over the cover sheet 140. Although the electrode layer 136 is typically patterned on the glass member 138, it should be noted that in some cases it may be alternatively or additionally patterned on the protective cover sheet 140.

FIG. 9 is a top view of a transparent multipoint touch screen 150, in accordance with another embodiment of the present invention. By way of example, the touch screen 150 may generally correspond to the touch screen of FIGS. 2 and 4. Unlike the touch screen shown in FIGS. 6-8, the touch screen of FIG. 9 utilizes the concept of mutual capacitance rather than self capacitance. As shown, the touch screen 150 includes a two layer grid of spatially separated lines or wires 152. In most cases, the lines 152 on each layer are parallel one another. Furthermore, although in different planes, the lines 152 on the different layers are configured to intersect or cross in order to produce capacitive sensing nodes 154, which each represent different coordinates in the plane of the touch screen 150. The nodes 154 are configured to receive capacitive input from an object touching the touch screen 150 in the vicinity of the node 154. When an object is proximate the node 154, the object steals charge thereby affecting the capacitance at the node 154.

To elaborate, the lines 152 on different layers serve two different functions. One set of lines 152A drives a current therethrough while the second set of lines 152B senses the capacitance coupling at each of the nodes 154. In most cases, the top layer provides the driving lines 152A while the bottom layer provides the sensing lines 152B. The driving lines 152A are connected to a voltage source (not shown) that separately drives the current through each of the driving lines 152A. That is, the stimulus is only happening over one line while all the other lines are grounded. They may be driven similarly to a raster scan. The sensing lines 152B are connected to a capacitive sensing circuit (not shown) that continuously senses all of the sensing lines 152B (always sensing).

When driven, the charge on the driving line 152A capacitively couples to the intersecting sensing lines 152B through the nodes 154 and the capacitive sensing circuit senses all of the sensing lines 152B in parallel. Thereafter, the next driving line 152A is driven, and the charge on the next driving line 152A capacitively couples to the intersecting sensing lines 152B through the nodes 154 and the capacitive sensing circuit senses all of the sensing lines 152B in parallel. This happens sequentially until all the lines 152A have been driven. Once all the lines 152A have been driven, the sequence starts over (continuously repeats). In most cases, the lines 152A are sequentially driven from one side to the opposite side.

The capacitive sensing circuit typically includes one or more sensor ICs that measure the capacitance in each of the sensing lines 152B and that reports its findings to a host controller. The sensor ICs may for example convert the analog capacitive signals to digital data and thereafter transmit the digital data over a serial bus to a host controller. Any number of sensor ICs may be used. For example, a sensor IC may be used for all lines, or multiple sensor ICs may be used for a single or group of lines. In most cases, the sensor ICs 110 report tracking signals, which are a function of both the position of the node 154 and the intensity of the capacitance at the node 154.

The lines 152 are generally disposed on one or more optical transmissive members 156 formed from a clear material such as glass or plastic. By way of example, the lines 152 may be placed on opposing sides of the same member 156 or they may be placed on different members 156. The lines 152 may be placed on the member 156 using any suitable patterning

14

technique including for example, deposition, etching, printing and the like. Furthermore, the lines 152 can be made from any suitable transparent conductive material. By way of example, the lines may be formed from indium tin oxide (ITO). The driving lines 152A are typically coupled to the voltage source through a flex circuit 158A, and the sensing lines 152B are typically coupled to the sensing circuit, and more particularly the sensor ICs through a flex circuit 158B. The sensor ICs may be attached to a printed circuit board (PCB). Alternatively, the sensor ICs may be placed directly on the member 156 thereby eliminating the flex circuit 158B.

The distribution of the lines 152 may be widely varied. For example, the lines 152 may be positioned almost anywhere in the plane of the touch screen 150. The lines 152 may be positioned randomly or in a particular pattern about the touch screen 150. With regards to the later, the position of the lines 152 may depend on the coordinate system used. For example, the lines 152 may be placed in rows and columns for Cartesian coordinates or concentrically and radially for polar coordinates. When using rows and columns, the rows and columns may be placed at various angles relative to one another. For example, they may be vertical, horizontal or diagonal.

Furthermore, the lines 152 may be formed from almost any shape whether rectilinear or curvilinear. The lines on each layer may be the same or different. For example, the lines may alternate between rectilinear and curvilinear. Further still, the shape of the opposing lines may have identical shapes or they may have different shapes. For example, the driving lines may have a first shape while the sensing lines may have a second shape that is different than the first shape. The geometry of the lines 152 (e.g., linewidths and spacing) may also be widely varied. The geometry of the lines within each layer may be identical or different, and further, the geometry of the lines for both layers may be identical or different. By way of example, the linewidths of the sensing lines 152B to driving lines 152A may have a ratio of about 2:1.

Moreover, any number of lines 152 may be used. It is generally believed that the number of lines is dependent on the desired resolution of the touch screen 150. The number of lines within each layer may be identical or different. The number of lines is typically determined by the size of the touch screen as well as the desired pitch and linewidths of the lines 152.

In the illustrated embodiment, the driving lines 152A are positioned in rows and the sensing lines 152B are positioned in columns that are perpendicular to the rows. The rows extend horizontally to the sides of the touch screen 150 and the columns extend vertically to the top and bottom of the touch screen 150. Furthermore, the linewidths for the set of lines 152A and 152B are different and the pitch for set of lines 152A and 152B are equal to one another. In most cases, the linewidths of the sensing lines 152B are larger than the linewidths of the driving lines 152A. By way of example, the pitch of the driving and sensing lines 152 may be about 5 mm, the linewidths of the driving lines 152A may be about 1.05 mm and the linewidths of the sensing lines 152B may be about 2.10 mm. Moreover, the number of lines 152 in each layer is different. For example, there may be about 38 driving lines and about 50 sensing lines.

As mentioned above, the lines in order to form semi-transparent conductors on glass, film or plastic, may be patterned with an ITO material. This is generally accomplished by depositing an ITO layer over the substrate surface, and then by etching away portions of the ITO layer in order to form the lines. As should be appreciated, the areas with ITO tend to have lower transparency than the areas without ITO. This is generally less desirable for the user as the user can distinguish

US 7,663,607 B2

15

the lines from the spaces therebetween, i.e., the patterned ITO can become quite visible thereby producing a touch screen with undesirable optical properties. To further exacerbate this problem, the ITO material is typically applied in a manner that produces a relatively low resistance, and unfortunately low resistance ITO tends to be less transparent than high resistance ITO.

In order to prevent the aforementioned problem, the dead areas between the ITO may be filled with indexing matching materials. In another embodiment, rather than simply etching away all of the ITO, the dead areas (the uncovered spaces) may be subdivided into unconnected electrically floating ITO pads, i.e., the dead areas may be patterned with spatially separated pads. The pads are typically separated with a minimum trace width. Furthermore, the pads are typically made small to reduce their impact on the capacitive measurements. This technique attempts to minimize the appearance of the ITO by creating a uniform optical retarder. That is, by seeking to create a uniform sheet of ITO, it is believed that the panel will function closer to a uniform optical retarder and therefore non-uniformities in the visual appearance will be minimized. In yet another embodiment, a combination of index matching materials and unconnected floating pads may be used.

FIG. 10 is a partial front elevation view, in cross section of a display arrangement 170, in accordance with one embodiment of the present invention. The display arrangement 170 includes an LCD display 172 and a touch screen 174 positioned over the LCD display 170. The touch screen may for example correspond to the touch screen shown in FIG. 9. The LCD display 172 may correspond to any conventional LCD display known in the art. Although not shown, the LCD display 172 typically includes various layers including a fluorescent panel, polarizing filters, a layer of liquid crystal cells, a color filter and the like.

The touch screen 174 includes a transparent sensing layer 176 that is positioned over a first glass member 178. The sensing layer 176 includes a plurality of sensor lines 177 positioned in columns (extend in and out of the page). The first glass member 178 may be a portion of the LCD display 172 or it may be a portion of the touch screen 174. For example, it may be the front glass of the LCD display 172 or it may be the bottom glass of the touch screen 174. The sensor layer 176 is typically disposed on the glass member 178 using suitable transparent conductive materials and patterning techniques. In some cases, it may be necessary to coat the sensor layer 176 with material of similar refractive index to improve the visual appearance, i.e., make more uniform.

The touch screen 174 also includes a transparent driving layer 180 that is positioned over a second glass member 182. The second glass member 182 is positioned over the first glass member 178. The sensing layer 176 is therefore sandwiched between the first and second glass members 178 and 182. The second glass member 182 provides an insulating layer between the driving and sensing layers 176 and 180. The driving layer 180 includes a plurality of driving lines 181 positioned in rows (extend to the right and left of the page). The driving lines 181 are configured to intersect or cross the sensing lines 177 positioned in columns in order to form a plurality of capacitive coupling nodes 182. Like the sensing layer 176, the driving layer 180 is disposed on the glass member using suitable materials and patterning techniques. Furthermore, in some cases, it may be necessary to coat the driving layer 180 with material of similar refractive index to improve the visual appearance. Although the sensing layer is typically patterned on the first glass member, it should be noted that in some cases it may be alternatively or additionally patterned on the second glass member.

16

The touch screen 174 also includes a protective cover sheet 190 disposed over the driving layer 180. The driving layer 180 is therefore sandwiched between the second glass member 182 and the protective cover sheet 190. The protective cover sheet 190 serves to protect the under layers and provide a surface for allowing an object to slide thereon. The protective cover sheet 190 also provides an insulating layer between the object and the driving layer 180. The protective cover sheet is suitably thin to allow for sufficient coupling. The protective cover sheet 190 may be formed from any suitable clear material such as glass and plastic. In addition, the protective cover sheet 190 may be treated with coatings to reduce stiction when touching and reduce glare when viewing the underlying LCD display 172. By way of example, a low stiction/anti reflective coating may be applied over the cover sheet 190. Although the line layer is typically patterned on a glass member, it should be noted that in some cases it may be alternatively or additionally patterned on the protective cover sheet.

The touch screen 174 also includes various bonding layers 192. The bonding layers 192 bond the glass members 178 and 182 as well as the protective cover sheet 190 together to form the laminated structure and to provide rigidity and stiffness to the laminated structure. In essence, the bonding layers 192 help to produce a monolithic sheet that is stronger than each of the individual layers taken alone. In most cases, the first and second glass members 178 and 182 as well as the second glass member and the protective sheet 182 and 190 are laminated together using a bonding agent such as glue. The compliant nature of the glue may be used to absorb geometric variations so as to form a singular composite structure with an overall geometry that is desirable. In some cases, the bonding agent includes an index matching material to improve the visual appearance of the touch screen 170.

With regards to configuration, each of the various layers may be formed with various sizes, shapes, and the like. For example, each of the layers may have the same thickness or a different thickness than the other layers in the structure. In the illustrated embodiment, the first glass member 178 has a thickness of about 1.1 mm, the second glass member 182 has a thickness of about 0.4 mm and the protective sheet has a thickness of about 0.55 mm. The thickness of the bonding layers 192 typically varies in order to produce a laminated structure with a desired height. Furthermore, each of the layers may be formed with various materials. By way of example, each particular type of layer may be formed from the same or different material. For example, any suitable glass or plastic material may be used for the glass members. In a similar manner, any suitable bonding agent may be used for the bonding layers 192.

FIGS. 11A and 11B are partial top view diagrams of a driving layer 200 and a sensing layer 202, in accordance with one embodiment. In this embodiment, each of the layers 200 and 202 includes dummy features 204 disposed between the driving lines 206 and the sensing lines 208. The dummy features 204 are configured to optically improve the visual appearance of the touch screen by more closely matching the optical index of the lines. While index matching materials may improve the visual appearance, it has been found that there still may exist some non-uniformities. The dummy features 204 provide the touch screen with a more uniform appearance. The dummy features 204 are electrically isolated and positioned in the gaps between each of the lines 206 and 208. Although they may be patterned separately, the dummy features 204 are typically patterned along with the lines 206 and 208. Furthermore, although they may be formed from different materials, the dummy features 204 are typically formed with the same transparent conductive material as the

US 7,663,607 B2

17

lines as for example ITO to provide the best possible index matching. As should be appreciated, the dummy features will more than likely still produce some gaps, but these gaps are much smaller than the gaps found between the lines (many orders of magnitude smaller). These gaps, therefore have minimal impact on the visual appearance. While this may be the case, index matching materials may be additionally applied to the gaps between the dummy features to further improve the visual appearance of the touch screen. The distribution, size, number, dimension, and shape of the dummy features may be widely varied.

FIG. 12 is a simplified diagram of a mutual capacitance circuit 220, in accordance with one embodiment of the present invention. The mutual capacitance circuit 220 includes a driving line 222 and a sensing line 224 that are spatially separated thereby forming a capacitive coupling node 226. The driving line 222 is electrically coupled to a voltage source 228, and the sensing line 224 is electrically coupled to a capacitive sensing circuit 230. The driving line 222 is configured to carry a current to the capacitive coupling node 226, and the sensing line 224 is configured to carry a current to the capacitive sensing circuit 230. When no object is present, the capacitive coupling at the node 226 stays fairly constant. When an object 232 such as a finger is placed proximate the node 226, the capacitive coupling changes through the node 226 changes. The object 232 effectively shunts some of the field away so that the charge projected across the node 226 is less. The change in capacitive coupling changes the current that is carried by the sensing lines 224. The capacitive sensing circuit 230 notes the current change and the position of the node 226 where the current change occurred and reports this information in a raw or in some processed form to a host controller. The capacitive sensing circuit does this for each node 226 at about the same time (as viewed by a user) so as to provide multipoint sensing.

The sensing line 224 may contain a filter 236 for eliminating parasitic capacitance 237, which may for example be created by the large surface area of the row and column lines relative to the other lines and the system enclosure at ground potential. Generally speaking, the filter rejects stray capacitance effects so that a clean representation of the charge transferred across the node 226 is outputted (and not anything in addition to that). That is, the filter 236 produces an output that is not dependent on the parasitic capacitance, but rather on the capacitance at the node 226. As a result, a more accurate output is produced.

FIG. 13 is a diagram of an inverting amplifier 240, in accordance with one embodiment of the present invention. The inverting amplifier 240 may generally correspond to the filter 236 shown in FIG. 12. As shown, the inverting amplifier includes a non inverting input that is held at a constant voltage (in this case ground), an inverting input that is coupled to the node and an output that is coupled to the capacitive sensing circuit 230. The output is coupled back to the inverting input through a capacitor. During operation, the input from the node may be disturbed by stray capacitance effects, i.e., parasitic capacitance. If so, the inverting amplifier is configured to drive the input back to the same voltage that it had been previously before the stimulus. As such, the value of the parasitic capacitance doesn't matter.

FIG. 14 is a block diagram of a capacitive sensing circuit 260, in accordance with one embodiment of the present invention. The capacitive sensing circuit 260 may for example correspond to the capacitive sensing circuits described in the previous figures. The capacitive sensing circuit 260 is configured to receive input data from a plurality of

18

sensing points 262 (electrode, nodes, etc.), to process the data and to output processed data to a host controller.

The sensing circuit 260 includes a multiplexer 264 (MUX). The multiplexer 264 is a switch configured to perform time multiplexing. As shown, the MUX 264 includes a plurality of independent input channels 266 for receiving signals from each of the sensing points 262 at the same time. The MUX 264 stores all of the incoming signals at the same time, but sequentially releases them one at a time through an output channel 268.

The sensing circuit 260 also includes an analog to digital converter 270 (ADC) operatively coupled to the MUX 264 through the output channel 268. The ADC 270 is configured to digitize the incoming analog signals sequentially one at a time. That is, the ADC 270 converts each of the incoming analog signals into outgoing digital signals. The input to the ADC 270 generally corresponds to a voltage having a theoretically infinite number of values. The voltage varies according to the amount of capacitive coupling at each of the sensing points 262. The output to the ADC 270, on the other hand, has a defined number of states. The states generally have predictable exact voltages or currents.

The sensing circuit 260 also includes a digital signal processor 272 (DSP) operatively coupled to the ADC 270 through another channel 274. The DSP 272 is a programmable computer processing unit that works to clarify or standardize the digital signals via high speed mathematical processing. The DSP 274 is capable of differentiating between human made signals, which have order, and noise, which is inherently chaotic. In most cases, the DSP performs filtering and conversion algorithms using the raw data. By way of example, the DSP may filter noise events from the raw data, calculate the touch boundaries for each touch that occurs on the touch screen at the same time, and thereafter determine the coordinates for each touch event. The coordinates of the touch events may then be reported to a host controller where they can be compared to previous coordinates of the touch events to determine what action to perform in the host device.

FIG. 15 is a flow diagram 280, in accordance with one embodiment of the present invention. The method generally begins at block 282 where a plurality of sensing points are driven. For example, a voltage is applied to the electrodes in self capacitance touch screens or through driving lines in mutual capacitance touch screens. In the later, each driving line is driven separately. That is, the driving lines are driven one at a time thereby building up charge on all the intersecting sensing lines. Following block 282, the process flow proceeds to block 284 where the outputs (voltage) from all the sensing points are read. This block may include multiplexing and digitizing the outputs. For example, in mutual capacitance touch screens, all the sensing points on one row are multiplexed and digitized and this is repeated until all the rows have been sampled. Following block 284, the process flow proceeds to block 286 where an image or other form of data (signal or signals) of the touch screen plane at one moment in time can be produced and thereafter analyzed to determine where the objects are touching the touch screen. By way of example, the boundaries for each unique touch can be calculated, and thereafter the coordinates thereof can be found. Following block 286, the process flow proceeds to block 288 where the current image or signal is compared to a past image or signal in order to determine a change in pressure, location, direction, speed and acceleration for each object on the plane of the touch screen. This information can be subsequently used to perform an action as for example moving a pointer or cursor or making a selection as indicated in block 290.

US 7,663,607 B2

19

FIG. 16 is a flow diagram of a digital signal processing method 300, in accordance with one embodiment of the present invention. By way of example, the method may generally correspond to block 286 shown and described in FIG. 15. The method 300 generally begins at block 302 where the raw data is received. The raw data is typically in a digitized form, and includes values for each node of the touch screen. The values may be between 0 and 256 where 0 equates to the highest capacitive coupling (no touch pressure) and 256 equates to the least capacitive coupling (full touch pressure). An example of raw data at one point in time is shown in FIG. 17A. As shown in FIG. 17A, the values for each point are provided in gray scale where points with the least capacitive coupling are shown in white and the points with the highest capacitive coupling are shown in black and the points found between the least and the highest capacitive coupling are shown in gray.

Following block 302, the process flow proceeds to block 304 where the raw data is filtered. As should be appreciated, the raw data typically includes some noise. The filtering process is configured to reduce the noise. By way of example, a noise algorithm may be run that removes points that aren't connected to other points. Single or unconnected points generally indicate noise while multiple connected points generally indicate one or more touch regions, which are regions of the touch screen that are touched by objects. An example of a filtered data is shown in FIG. 17B. As shown, the single scattered points have been removed thereby leaving several concentrated areas.

Following block 304, the process flow proceeds to block 306 where gradient data is generated. The gradient data indicates the topology of each group of connected points. The topology is typically based on the capacitive values for each point. Points with the lowest values are steep while points with the highest values are shallow. As should be appreciated, steep points indicate touch points that occurred with greater pressure while shallow points indicate touch points that occurred with lower pressure. An example of gradient data is shown in FIG. 17C.

Following block 306, the process flow proceeds to block 308 where the boundaries for touch regions are calculated based on the gradient data. In general, a determination is made as to which points are grouped together to form each touch region. An example of the touch regions is shown in FIG. 17D.

In one embodiment, the boundaries are determined using a watershed algorithm. Generally speaking, the algorithm performs image segmentation, which is the partitioning of an image into distinct regions as for example the touch regions of multiple objects in contact with the touchscreen. The concept of watershed initially comes from the area of geography and more particularly topography where a drop of water falling on a relief follows a descending path and eventually reaches a minimum, and where the watersheds are the divide lines of the domains of attracting drops of water. Herein, the watershed lines represent the location of pixels, which best separate different objects touching the touch screen. Watershed algorithms can be widely varied. In one particular implementation, the watershed algorithm includes forming paths from low points to a peak (based on the magnitude of each point), classifying the peak as an ID label for a particular touch region, associating each point (pixel) on the path with the peak. These steps are performed over the entire image map thus carving out the touch regions associated with each object in contact with the touchscreen.

Following block 308, the process flow proceeds to block 310 where the coordinates for each of the touch regions are

20

calculated. This may be accomplished by performing a centroid calculation with the raw data associated with each touch region. For example, once the touch regions are determined, the raw data associated therewith may be used to calculate the centroid of the touch region. The centroid may indicate the central coordinate of the touch region. By way of example, the X and Y centroids may be found using the following equations:

$$X_c = \frac{\sum Z * x}{\sum Z}; \text{ and}$$

$$Y_c = \frac{\sum Z * y}{\sum Z},$$

where

X_c represents the x centroid of the touch region

Y_c represents the y centroid of the touch region

x represents the x coordinate of each pixel or point in the touch region

y represents the y coordinate of each pixel or point in the touch region

Z represents the magnitude (capacitance value) at each pixel or point

An example of a centroid calculation for the touch regions is shown in FIG. 17E. As shown, each touch region represents a distinct x and y coordinate. These coordinates may be used to perform multipoint tracking as indicated in block 312. For example, the coordinates for each of the touch regions may be compared with previous coordinates of the touch regions to determine positioning changes of the objects touching the touch screen or whether or not touching objects have been added or subtracted or whether a particular object is being tapped.

FIGS. 18 and 19 are side elevation views of an electronic device 350, in accordance with multiple embodiments of the present invention. The electronic device 350 includes an LCD display 352 and a transparent touch screen 354 positioned over the LCD display 352. The touch screen 354 includes a protective sheet 356, one or more sensing layers 358, and a bottom glass member 360. In this embodiment, the bottom glass member 360 is the front glass of the LCD display 352. Further, the sensing layers 358 may be configured for either self or mutual capacitance as described above. The sensing layers 358 generally include a plurality of interconnects at the edge of the touch screen for coupling the sensing layer 358 to a sensing circuit (not shown). By way of example, the sensing layer 358 may be electrically coupled to the sensing circuit through one or more flex circuits 362, which are attached to the sides of the touch screen 354.

As shown, the LCD display 352 and touch screen 354 are disposed within a housing 364. The housing 364 serves to cover and support these components in their assembled position within the electronic device 350. The housing 364 provides a space for placing the LCD display 352 and touch screen 354 as well as an opening 366 so that the display screen can be seen through the housing 364. In one embodiment, as shown in FIG. 18, the housing 364 includes a facade 370 for covering the sides the LCD display 352 and touch screen 354. Although not shown in great detail, the facade 370 is positioned around the entire perimeter of the LCD display 352 and touch screen 354. The facade 370 serves to hide the interconnects leaving only the active area of the LCD display 352 and touch screen 354 in view.

In another embodiment, as shown in FIG. 19, the housing 364 does not include a facade 370, but rather a mask 372 that is printed on interior portion of the top glass 374 of the touch screen 354 that extends between the sides of the housing 364. This particular arrangement makes the mask 372 look submerged in the top glass 356. The mask 372 serves the same

function as the facade 370, but is a more elegant solution. In one implementation, the mask 372 is a formed from high temperature black polymer. In the illustrated embodiment of FIG. 19, the touch screen 354 is based on mutual capacitance sensing and thus the sensing layer 358 includes driving lines 376 and sensing lines 378. The driving lines 376 are disposed on the top glass 356 and the mask 372, and the sensing lines 378 are disposed on the bottom glass 360. The driving lines and sensing lines 376 and 378 are insulated from one another via a spacer 380. The spacer 380 may for example be a clear piece of plastic with optical matching materials retained therein or applied thereto.

In one embodiment and referring to both FIGS. 18 and 19, the electronic device 350 corresponds to a tablet computer. In this embodiment, the housing 364 also encloses various integrated circuit chips and other circuitry 382 that provide computing operations for the tablet computer. By way of example, the integrated circuit chips and other circuitry may include a microprocessor, motherboard, Read-Only Memory (ROM), Random-Access Memory (RAM), a hard drive, a disk drive, a battery, and various input/output support devices.

While this invention has been described in terms of several preferred embodiments, there are alterations, permutations, and equivalents, which fall within the scope of this invention. For example, although the touch screen was primarily directed at capacitive sensing, it should be noted that some or all of the features described herein may be applied to other sensing methodologies. It should also be noted that there are many alternative ways of implementing the methods and apparatuses of the present invention. It is therefore intended that the following appended claims be interpreted as including all such alterations, permutations, and equivalents as fall within the true spirit and scope of the present invention.

What is claimed is:

1. A touch panel comprising a transparent capacitive sensing medium configured to detect multiple touches or near touches that occur at a same time and at distinct locations in a plane of the touch panel and to produce distinct signals representative of a location of the touches on the plane of the touch panel for each of the multiple touches, wherein the transparent capacitive sensing medium comprises:

- a first layer having a plurality of transparent first conductive lines that are electrically isolated from one another; and
- a second layer spatially separated from the first layer and having a plurality of transparent second conductive lines that are electrically isolated from one another, the second conductive lines being positioned transverse to the first conductive lines, the intersection of transverse lines being positioned at different locations in the plane of the touch panel, each of the second conductive lines being operatively coupled to capacitive monitoring circuitry; wherein the capacitive monitoring circuitry is configured to detect changes in charge coupling between the first conductive lines and the second conductive lines.

2. The touch panel as recited in claim 1 wherein the conductive lines on each of the layers are substantially parallel to one another.

3. The touch panel as recited in claim 2 wherein the conductive lines on different layers are substantially perpendicular to one another.

4. The touch panel as recited in claim 1 wherein the transparent first conductive lines of the first layer are disposed on a first glass member, and wherein the transparent second conductive lines of the second layer are disposed on a second glass member, the first glass member being disposed over the second glass member.

5. The touch panel as recited in claim 4 further including a third glass member disposed over the first glass member, the first and second glass members being attached to one another via an adhesive layer, the third glass member being attached to the first glass member via another adhesive layer.

6. The touch panel as recited in claim 1 wherein the conductive lines are formed from indium tin oxide (ITO).

7. The touch panel as recited in claim 1, wherein the capacitive sensing medium is a mutual capacitance sensing medium.

8. The touch panel as recited in claim 7, further comprising a virtual ground charge amplifier coupled to the touch panel for detecting the touches on the touch panel.

9. The touch panel as recited in claim 1, the transparent capacitive sensing medium formed on both sides of a single substrate.

10. A display arrangement comprising:

- a display having a screen for displaying a graphical user interface; and
- a transparent touch panel allowing the screen to be viewed therethrough and capable of recognizing multiple touch events that occur at different locations on the touch panel at a same time and to output this information to a host device to form a pixilated image; wherein the touch panel includes a multipoint sensing arrangement configured to simultaneously detect and monitor the touch events and a change in capacitive coupling associated with those touch events at distinct points across the touch panel; and wherein the touch panel comprises:

- a first glass member disposed over the screen of the display;
- a first transparent conductive layer disposed over the first glass member, the first transparent conductive layer comprising a plurality of spaced apart parallel lines having the same pitch and linewidths;
- a second glass member disposed over the first transparent conductive layer;
- a second transparent conductive layer disposed over the second glass member, the second transparent conductive layer comprising a plurality of spaced apart parallel lines having the same pitch and linewidths, the parallel lines of the second transparent conductive layer being substantially perpendicular to the parallel lines of the first transparent conductive layer;
- a third glass member disposed over the second transparent conductive layer; and
- one or more sensor integrated circuits operatively coupled to the lines.

11. The display arrangement as recited in claim 10 further including dummy features disposed in the space between the parallel lines, the dummy features optically improving the visual appearance of the touch screen by more closely matching the optical index of the lines.

* * * * *

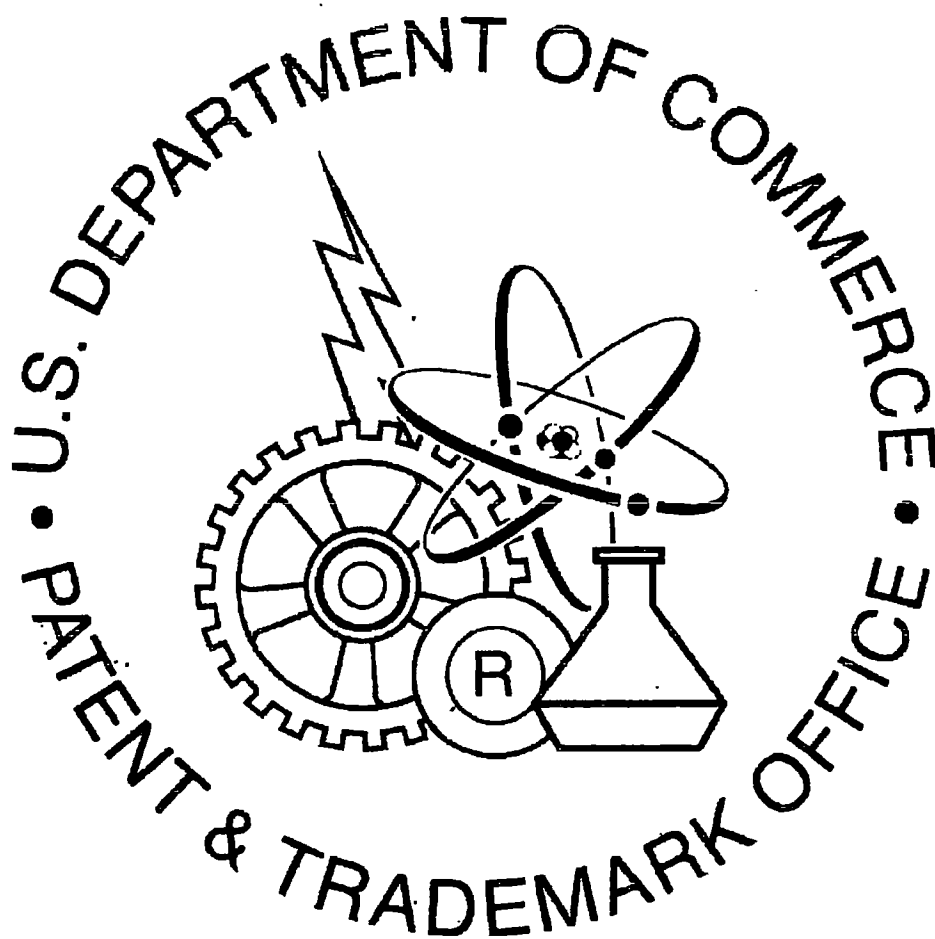

PTO:14683
(Rev. 7-96)

750 Apple 0012310

A563

JX-002.033

Patent No. 7,812,828,
Dated October 12, 2010

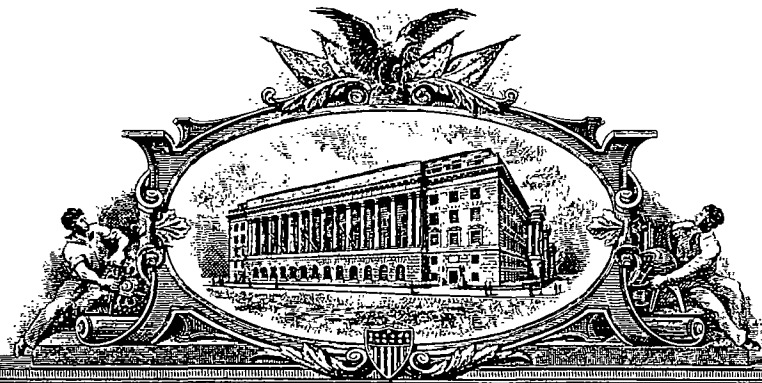

THE UNITED STATES OF AMERICA

TO ALL TO WHOM THESE PRESENTS SHALL COME:

**UNITED STATES DEPARTMENT OF COMMERCE
United States Patent and Trademark Office**

October 27, 2010

**THIS IS TO CERTIFY THAT ANNEXED HERETO IS A TRUE COPY FROM
THE RECORDS OF THIS OFFICE OF:**

**U.S. PATENT: 7,812,828
ISSUE DATE: October 12, 2010**

**By Authority of the
Under Secretary of Commerce for Intellectual Property
and Director of the United States Patent and Trademark Office**



E. Bornett
E. BORNETT
Certifying Officer



US007812828B2

(12) **United States Patent**
Westerman et al.

(10) **Patent No.:** US 7,812,828 B2
(45) **Date of Patent:** Oct. 12, 2010

- (54) **ELLIPSE FITTING FOR MULTI-TOUCH SURFACES**
4,246,452 A 1/1981 Chandler
4,266,144 A 5/1981 Bristol
4,290,061 A 9/1981 Serrano
4,291,303 A 9/1981 Cutler et al.
4,550,221 A 10/1985 Mabusth
4,561,002 A 12/1985 Chiu
4,672,364 A 6/1987 Lucas
4,672,558 A 6/1987 Beckes et al.
- (75) Inventors: **Wayne Westerman**, San Francisco, CA (US); **John G. Elias**, Townsend, DE (US)
- (73) Assignee: **Apple Inc.**, Cupertino, CA (US)
- (*) Notice: Subject to any disclaimer, the term of this patent is extended or adjusted under 35 U.S.C. 154(b) by 707 days.

(Continued)

(21) Appl. No.: **11/677,958**

FOREIGN PATENT DOCUMENTS

(22) Filed: **Feb. 22, 2007**

CA 1243096 10/1988

(65) **Prior Publication Data**

US 2007/0139395 A1 Jun. 21, 2007

(Continued)

Related U.S. Application Data

OTHER PUBLICATIONS

(63) Continuation of application No. 11/015,434, filed on Dec. 17, 2004, now Pat. No. 7,339,580, which is a continuation of application No. 09/236,513, filed on Jan. 25, 1999, now Pat. No. 6,323,846.

Chang, C-C. et al. (Aug. 1, 1993), "A Hashing-Oriented Nearest Neighbor Searching Scheme," *Pattern Recognition Letters*, 14(8):625-630.

(60) Provisional application No. 60/072,509, filed on Jan. 26, 1998.

(Continued)

(51) **Int. Cl.**
G06F 3/041 (2006.01)

Primary Examiner—Amare Mengistu
Assistant Examiner—Koosha Sharifi
(74) *Attorney, Agent, or Firm*—Morrison & Foerster LLP

(52) **U.S. Cl.** 345/173; 345/174; 345/175; 178/18.01; 178/18.03

(57) **ABSTRACT**

(58) **Field of Classification Search** 345/173-178; 178/18.01, 18.03, 19.01, 20.01; 715/863
See application file for complete search history.

Apparatus and methods are disclosed for simultaneously tracking multiple finger and palm contacts as hands approach, touch, and slide across a proximity-sensing, multi-touch surface. Identification and classification of intuitive hand configurations and motions enables unprecedented integration of typing, resting, pointing, scrolling, 3D manipulation, and handwriting into a versatile, ergonomic computer input device.

(56) **References Cited**

U.S. PATENT DOCUMENTS

- 3,333,160 A 7/1967 Gorski
- 3,541,541 A 11/1970 Engelhart
- 3,662,105 A 5/1972 Hurst et al.
- 3,798,370 A 3/1974 Hurst
- 4,237,421 A 12/1980 Waldron

35 Claims, 45 Drawing Sheets

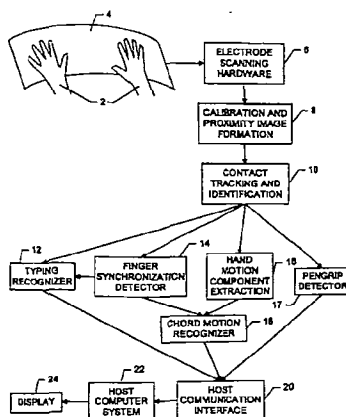

US 7,812,828 B2

Page 2

U.S. PATENT DOCUMENTS

4,692,809 A	9/1987	Beining et al.	5,729,249 A	3/1998	Yasutake
4,695,827 A	9/1987	Beining et al.	5,729,250 A	3/1998	Bishop et al.
4,733,222 A	3/1988	Evans	5,730,165 A	3/1998	Philipp
4,734,685 A	3/1988	Watanabe	5,736,976 A	4/1998	Cheung
4,746,770 A	5/1988	McAvinney	5,741,990 A	4/1998	Davies
4,771,276 A	9/1988	Parks	5,745,116 A	4/1998	Pisutha-Amond
4,788,384 A	11/1988	Bruere-Dawson et al.	5,745,716 A	4/1998	Tchao et al.
4,806,846 A	2/1989	Kerber	5,746,818 A	5/1998	Yatake
4,898,555 A	2/1990	Sampson	5,748,184 A *	5/1998	Shieh 345/173
4,968,877 A	11/1990	McAvinney et al.	5,748,269 A	5/1998	Harris et al.
5,003,519 A	3/1991	Noirjean	5,764,222 A	6/1998	Shieh
5,017,030 A	5/1991	Crews	5,767,457 A	6/1998	Gerpheide et al.
5,178,477 A	1/1993	Gambaro	5,767,842 A	6/1998	Korth
5,189,403 A	2/1993	Franz et al.	5,790,104 A	8/1998	Shieh
5,194,862 A	3/1993	Edwards	5,790,107 A	8/1998	Kasser et al.
5,224,861 A	7/1993	Glass et al.	5,802,516 A	9/1998	Shwarts et al.
5,241,308 A	8/1993	Young	5,808,567 A	9/1998	McCloud
5,252,951 A	10/1993	Tannenbaum et al.	5,809,267 A	9/1998	Moran et al.
5,270,711 A	12/1993	Knapp et al.	5,821,690 A	10/1998	Martens et al.
5,281,966 A	1/1994	Walsh	5,821,930 A	10/1998	Hansen
5,305,017 A	4/1994	Gerpheide	5,823,782 A	10/1998	Marcus et al.
5,327,161 A	7/1994	Logan et al.	5,825,351 A	10/1998	Tam
5,345,543 A	9/1994	Capps et al.	5,825,352 A *	10/1998	Bisset et al. 345/173
5,369,228 A	11/1994	Faust	5,835,079 A	11/1998	Shieh
5,376,948 A	12/1994	Roberts	5,837,947 A	11/1998	Teterwak
5,379,057 A	1/1995	Clough et al.	5,854,625 A	12/1998	Frisch et al.
5,398,310 A	3/1995	Tchao et al.	5,856,824 A	1/1999	Shieh
5,442,742 A	8/1995	Greyson et al.	5,877,748 A	3/1999	Redlich
5,463,388 A	10/1995	Boie et al.	5,880,411 A	3/1999	Gillespie et al.
5,463,696 A	10/1995	Beernink et al.	5,883,619 A	3/1999	Ho et al.
5,471,578 A	11/1995	Moran et al.	5,886,697 A	3/1999	Naughton et al.
5,479,528 A	12/1995	Speeter	5,896,126 A *	4/1999	Shieh 345/173
5,483,261 A	1/1996	Yasutake	5,898,434 A	4/1999	Small et al.
5,488,204 A	1/1996	Mead et al.	5,917,476 A	6/1999	Czerniecki
5,495,077 A	2/1996	Miller et al.	5,920,309 A	7/1999	Bisset et al.
5,513,309 A	4/1996	Meier et al.	5,923,319 A	7/1999	Bishop et al.
5,523,775 A	6/1996	Capps	5,933,134 A	8/1999	Shieh
5,530,455 A	6/1996	Gillick et al.	5,943,043 A	8/1999	Furuhata et al.
5,543,590 A	8/1996	Gillespie et al.	5,943,044 A	8/1999	Martinelli et al.
5,543,591 A	8/1996	Gillespie et al.	5,982,302 A	11/1999	Ure
5,548,667 A	8/1996	Tu	5,995,106 A	11/1999	Naughton et al.
5,563,632 A	10/1996	Roberts	6,002,389 A	12/1999	Kasser
5,563,996 A	10/1996	Tchao	6,002,808 A	12/1999	Freeman
5,565,658 A	10/1996	Gerpheide et al.	6,020,881 A	2/2000	Naughton et al.
5,579,036 A	11/1996	Yates, IV	6,031,524 A	2/2000	Kunert
5,581,276 A	12/1996	Cipolla et al.	6,037,882 A	3/2000	Levy
5,581,484 A	12/1996	Prince	6,050,825 A	4/2000	Nichol et al.
5,581,681 A	12/1996	Tchao et al.	6,052,339 A	4/2000	Frenkel et al.
5,583,946 A	12/1996	Gourdol	6,061,177 A	5/2000	Fujimoto
5,589,856 A	12/1996	Stein et al.	6,072,494 A	6/2000	Nguyen
5,590,219 A	12/1996	Gourdol	6,084,576 A	7/2000	Leu et al.
5,592,566 A	1/1997	Pagallo et al.	6,097,371 A	8/2000	Siddiqui et al.
5,594,469 A	1/1997	Freeman et al.	6,107,997 A	8/2000	Ure
5,594,810 A	1/1997	Gourdol	6,128,003 A	10/2000	Smith et al.
5,596,694 A	1/1997	Capps	6,131,299 A	10/2000	Raab et al.
5,612,719 A	3/1997	Beernink et al.	6,135,958 A	10/2000	Mikula-Curtis et al.
5,625,715 A	4/1997	Trew et al.	6,144,380 A	11/2000	Schwartz et al.
5,631,805 A	5/1997	Bonsall	6,147,680 A *	11/2000	Tareev 345/173
5,633,955 A	5/1997	Bozinovic et al.	6,154,209 A	11/2000	Naughton et al.
5,634,102 A	5/1997	Capps	6,160,551 A	12/2000	Naughton et al.
5,636,101 A	6/1997	Bonsall et al.	6,188,391 B1	2/2001	Seely et al.
5,642,108 A	6/1997	Gopher et al.	6,198,515 B1	3/2001	Cole
5,644,657 A	7/1997	Capps et al.	6,208,329 B1	3/2001	Ballare
5,666,113 A	9/1997	Logan	6,222,465 B1	4/2001	Kumar et al.
5,666,502 A	9/1997	Capps	6,239,790 B1	5/2001	Martinelli et al.
5,666,552 A	9/1997	Greyson et al.	6,243,071 B1	6/2001	Shwarts et al.
5,675,361 A	10/1997	Santilli	6,246,862 B1	6/2001	Grivas et al.
5,675,362 A	10/1997	Clough et al.	6,249,606 B1	6/2001	Kiraly et al.
5,677,710 A	10/1997	Thompson-Rohrlich	6,255,604 B1	7/2001	Tokioka et al.
5,689,253 A	11/1997	Hargreaves et al.	6,278,443 B1	8/2001	Amro et al.
5,710,844 A	1/1998	Capps et al.	6,288,707 B1	9/2001	Philipp
			6,289,326 B1	9/2001	LaFleur
			6,292,178 B1	9/2001	Bernstein et al.

US 7,812,828 B2

6,323,846	B1	11/2001	Westerman et al.	2006/0053387	A1	3/2006	Ording
6,323,849	B1	11/2001	He et al.	2006/0066582	A1	3/2006	Lyon et al.
6,344,861	B1	2/2002	Naughton et al.	2006/0085757	A1	4/2006	Andre et al.
6,347,290	B1	2/2002	Bartlett	2006/0097991	A1	5/2006	Hotelling et al.
6,377,009	B1	4/2002	Philipp	2006/0197753	A1	9/2006	Hotelling
6,380,931	B1	4/2002	Gillespie et al.	2006/0232567	A1	10/2006	Westerman et al.
6,411,287	B1	6/2002	Scharif et al.	2006/0238517	A1	10/2006	King et al.
6,414,671	B1	7/2002	Gillespie et al.	2006/0238518	A1	10/2006	Westerman et al.
6,421,234	B1	7/2002	Ricks et al.	2006/0238519	A1	10/2006	Westerman et al.
6,452,514	B1	9/2002	Philipp	2006/0238520	A1	10/2006	Westerman et al.
6,457,355	B1	10/2002	Philipp	2006/0238521	A1	10/2006	Westerman et al.
6,466,036	B1	10/2002	Philipp	2006/0238522	A1	10/2006	Westerman et al.
6,515,669	B1	2/2003	Mohri	2007/0070050	A1	3/2007	Westerman et al.
6,525,749	B1	2/2003	Moran et al.	2007/0070051	A1	3/2007	Westerman et al.
6,535,200	B2	3/2003	Philipp	2007/0070052	A1	3/2007	Westerman et al.
6,543,684	B1	4/2003	White et al.	2007/0078919	A1	4/2007	Westerman et al.
6,543,947	B2	4/2003	Lee	2007/0081726	A1	4/2007	Westerman et al.
6,570,557	B1	5/2003	Westerman et al.	2007/0229464	A1	10/2007	Hotelling et al.
6,593,916	B1	7/2003	Aroyan	2007/0236466	A1	10/2007	Hotelling
6,610,936	B2	8/2003	Gillespie et al.	2007/0247429	A1	10/2007	Westerman
6,624,833	B1	9/2003	Kumar et al.	2007/0257890	A1	11/2007	Hotelling et al.
6,639,577	B2	10/2003	Eberhard	2007/0268273	A1	11/2007	Westerman et al.
6,650,319	B1	11/2003	Hurst et al.	2007/0268274	A1	11/2007	Westerman et al.
6,658,994	B1	12/2003	McMillan	2007/0268275	A1	11/2007	Westerman et al.
6,670,894	B2	12/2003	Mehring	2008/0041639	A1	2/2008	Westerman et al.
6,677,932	B1	1/2004	Westerman	2008/0042986	A1	2/2008	Westerman et al.
6,677,934	B1	1/2004	Blanchard	2008/0042987	A1	2/2008	Westerman et al.
6,724,366	B2	4/2004	Crawford	2008/0042988	A1	2/2008	Westerman et al.
6,757,002	B1	6/2004	Oross et al.	2008/0042989	A1	2/2008	Westerman et al.
6,803,906	B1	10/2004	Morrison et al.	2008/0128182	A1	6/2008	Westerman et al.
6,842,672	B1	1/2005	Straub et al.	2009/0021489	A1	1/2009	Westerman et al.
6,856,259	B1	2/2005	Sharp	2009/0160816	A1	6/2009	Westerman et al.
6,888,536	B2	5/2005	Westerman et al.	2009/0244031	A1	10/2009	Westerman et al.
6,900,795	B1	5/2005	Knight, III et al.	2009/0244032	A1	10/2009	Westerman et al.
6,927,761	B2	8/2005	Badaye et al.	2009/0244033	A1	10/2009	Westerman et al.
6,942,571	B1	9/2005	McAllister et al.	2009/0249236	A1	10/2009	Westerman et al.
6,965,375	B1	11/2005	Gettemy et al.	2009/0251435	A1	10/2009	Westerman et al.
6,972,401	B2	12/2005	Akitt et al.	2009/0251438	A1	10/2009	Westerman et al.
6,977,666	B1	12/2005	Hedrick	2009/0251439	A1	10/2009	Westerman et al.
6,985,801	B1	1/2006	Straub et al.				
6,992,659	B2	1/2006	Gettemy				
7,031,228	B2	4/2006	Born et al.				
7,084,859	B1	8/2006	Pryor				
7,129,416	B1	10/2006	Steinfeld et al.				
7,240,289	B2	7/2007	Naughton et al.				
RE40,153	E	3/2008	Westerman et al.				
7,339,580	B2	3/2008	Westerman et al.				
2002/0118848	A1	8/2002	Karpenstein				
2002/0140668	A1	10/2002	Crawford				
2003/0006974	A1	1/2003	Clough et al.				
2003/0076301	A1	4/2003	Tsuk et al.				
2003/0076303	A1	4/2003	Huppi				
2003/0076306	A1	4/2003	Zadesky et al.				
2003/0095095	A1	5/2003	Pihlaja				
2003/0095096	A1	5/2003	Robbin et al.				
2003/0098858	A1	5/2003	Perski et al.				
2003/0132950	A1	7/2003	Surucu et al.				
2003/0164820	A1	9/2003	Kent				
2003/0206202	A1	11/2003	Moriya				
2003/0234768	A1	12/2003	Rekumoto et al.				
2004/0146688	A1	7/2004	Treat				
2004/0263484	A1	12/2004	Montysalo et al.				
2005/0012723	A1	1/2005	Pallakoff				
2005/0052425	A1	3/2005	Zadeski et al.				
2005/0104867	A1	5/2005	Westerman et al.				
2005/0110768	A1	5/2005	Marrion et al.				
2006/0022955	A1	2/2006	Kennedy				
2006/0022956	A1	2/2006	Lengeling et al.				
2006/0026521	A1	2/2006	Hotelling et al.				
2006/0026535	A1	2/2006	Hotelling et al.				
2006/0026536	A1	2/2006	Hotelling et al.				
2006/0032680	A1	2/2006	Elias et al.				
2006/0033724	A1	2/2006	Chaudhri et al.				

FOREIGN PATENT DOCUMENTS

DE	10251296	A1	5/2004
EP	0 546 704	A2	6/1993
EP	0 546 704	A3	6/1993
EP	0288692		7/1993
EP	0 622 722	A2	11/1994
EP	0 622 722	A3	11/1994
EP	0 622 722	B1	11/1994
EP	0664504		1/1995
EP	0464908		9/1996
EP	0 817 000	A1	1/1998
EP	0 817 000	B1	1/1998
EP	1014295		1/2002
GB	2330670	A	4/1999
JP	02-056017	A	2/1990
JP	02-304613	A	12/1990
JP	04-233619	A	8/1992
JP	06-083523	A	3/1994
JP	06-332620	A	12/1994
JP	07-057103	A	3/1995
JP	07-129312	A	5/1995
JP	08-286830	A	11/1996
JP	2000-163031	A	6/2000
WO	WO-92/02000		2/1992
WO	WO-96/07981	A1	3/1996
WO	WO-97/18547		5/1997
WO	WO-97/23738		7/1997
WO	WO-97/36225		10/1997
WO	WO-97/40744		11/1997
WO	WO-98/14863		4/1998
WO	WO-99/38149	A1	7/1999
WO	WO-03/088176		10/2003

US 7,812,828 B2

Page 4

WO WO2006/023569 3/2006

OTHER PUBLICATIONS

- Crowley, J.L. (Mar. 1, 1997). "Vision for Man-Machine Interaction," *Robotics and Autonomous Systems*, 19(3-4):347-358.
- Davis, J. et al. (May 2, 1994). "Recognizing Hand Gestures," *European Conference on Computer Vision*. Stockholm, SE, 1:331-340.
- European Search Report mailed Dec. 12, 2008, for EP Application No. 06016855.6 filed Jan. 25, 1999, six pages.
- European Search Report mailed Dec. 23, 2008, for EP Application No. 06016832.5 filed Jan. 25, 1999, seven pages.
- European Search Report mailed Jan. 9, 2009, for EP Application No. 06016832.5 filed Jan. 25, 1999, four pages.
- Heap, T. et al. (Oct. 14, 1996). "Towards 3D Hand Tracking Using a Deformable Model," *Proceedings of the 2nd International Conference*, Killington, VT, USA, Oct. 14-16, 1996, *Automatic Face and Gesture Recognition, IEEE Comput. Soc.*, pp. 140-145.
- International Search Report mailed Dec. 28, 2005, for PCT Application No. PCT/US05/03325, filed Feb. 3, 2005, two pages.
- Nirei, K. et al. (Aug. 5, 1996). "Human Hand Tracking from Binocular Image Sequences," *Proceedings of the 1996 IEEE IECON 22nd International Conference, Taipei, Taiwan, Aug. 5-10, 1996, Industrial Electronics, Control, and Instrumentation 1(5):297-302*.
- Non-Final Office Action mailed Sep. 21, 2007, for U.S. Appl. No. 11/428,515, filed Jul. 3, 2006, seven pages.
- Non-Final Office Action mailed Sep. 24, 2007, for U.S. Appl. No. 11/428,506, filed Jul. 3, 2006, six pages.
- Non-Final Office Action mailed Sep. 24, 2007, for U.S. Appl. No. 11/428,521, filed Jul. 3, 2006, six pages.
- Non-Final Office Action mailed Jan. 28, 2008, for U.S. Appl. No. 11/428,522, filed Jul. 3, 2006, seven pages.
- Non-Final Office Action mailed Feb. 4, 2008, for U.S. Appl. No. 11/428,515, filed Jul. 3, 2006, six pages.
- Non-Final Office Action mailed Jul. 9, 2008, for U.S. Appl. No. 11/428,521, filed Jul. 3, 2006, 11 pages.
- Non-Final Office Action mailed Sep. 2, 2008, for U.S. Appl. No. 11/428,522, filed Jul. 3, 2006, six pages.
- Non-Final Office Action mailed Sep. 15, 2008, for U.S. Appl. No. 11/428,506, filed Jul. 3, 2006, eight pages.
- Non-Final Office Action mailed Oct. 31, 2008, for U.S. Appl. No. 11/428,515, filed Jul. 3, 2006, seven pages.
- Non-Final Office Action mailed Feb. 17, 2009, for U.S. Appl. No. 11/428,522, filed Jul. 3, 2006, six pages.
- Notice of Allowability mailed Feb. 11, 2009, for U.S. Appl. No. 11/428,521, filed Jul. 3, 2006, five pages.
- U.S. Appl. No. 11/332,861, filed Jan. 13, 2006 which is a Reissue of 6,677,932.
- Westerman, W. (Jan. 1, 1999). "Hand Tracking, Finger Identification, and Chordic Manipulation on a Multi-Touch Surface," Dissertation, University of Delaware, pp. 1-333.
- Final Office Action mailed Mar. 19, 2009, for U.S. Appl. No. 11/428,506, filed Jul. 3, 2006, seven pages.
- Non-Final Office Action mailed Mar. 18, 2009, for U.S. Appl. No. 11/428,515, filed Jul. 3, 2006, 12 pages.
- Non-Final Office Action mailed Apr. 2, 2009, for U.S. Appl. No. 11/428,501, filed Jul. 3, 2006, 11 pages.
- Non-Final Office Action mailed Apr. 2, 2009, for U.S. Appl. No. 11/428,503, filed Jul. 3, 2006, 12 pages.
- Notice of Allowability mailed Jul. 10, 2009, for U.S. Appl. No. 11/428,521, filed Jul. 3, 2006, four pages.
- Rubine, D. (May 1992). "Combining Gestures and Direct Manipulation," CHI '92, pp. 659-660.
- U.S. Appl. No. 12/342,027, filed Dec. 22, 2008, by Westerman et al.
- U.S. Appl. No. 12/422,197, filed Apr. 10, 2009, by Westerman et al.
- U.S. Appl. No. 12/422,205, filed Apr. 10, 2009, by Westerman et al.
- U.S. Appl. No. 12/422,212, filed Apr. 10, 2009, by Westerman et al.
- U.S. Appl. No. 12/422,222, filed Apr. 10, 2009, by Westerman et al.
- U.S. Appl. No. 12/422,225, filed Apr. 10, 2009, by Westerman et al.
- U.S. Appl. No. 12/434,439, filed May 1, 2009, by Westerman et al.
- U.S. Appl. No. 12/479,573, filed Jun. 5, 2009, by Westerman et al.
- U.S. Appl. No. 12/479,617, filed Jun. 5, 2009, by Westerman et al.
- U.S. Appl. No. 12/479,678, filed Jun. 5, 2009, by Westerman et al.
- Cui, Y. et al. (1996). "Hand Segmentation Using Learning-Based Prediction and Verification for Hand Sign Recognition," *Proceedings of the 1996 IEEE Computer Society Conference on Computer Vision and Pattern Recognition*, pp. 88-93.
- Final Office Action mailed Nov. 19, 2009, for U.S. Appl. No. 11/428,515, filed Jul. 3, 2006, 14 pages.
- Non-Final Office Action mailed Aug. 25, 2009, for U.S. Appl. No. 11/428,522, filed Jul. 3, 2006, six pages.
- Non-Final Office Action mailed Sep. 2, 2009, for U.S. Appl. No. 11/559,736, filed Nov. 14, 2006, 12 pages.
- Non-Final Office Action mailed Oct. 5, 2009, for U.S. Appl. No. 11/559,799, filed Nov. 14, 2006, 14 pages.
- Non-Final Office Action mailed Oct. 6, 2009, for U.S. Appl. No. 11/559,763, filed Nov. 14, 2006, 24 pages.
- Non-Final Office Action mailed Oct. 14, 2009, for U.S. Appl. No. 11/428,501, filed Jul. 3, 2006, six pages.
- Non-Final Office Action mailed Oct. 29, 2009, for U.S. Appl. No. 11/559,822, filed Nov. 14, 2006, 11 pages.
- Non-Final Office Action mailed Oct. 30, 2009, for U.S. Appl. No. 11/428,503, filed Jul. 3, 2006, nine pages.
- Non-Final Office Action mailed Dec. 22, 2009, for U.S. Appl. No. 11/559,833, filed Nov. 14, 2006, six pages.
- Non-Final Office Action mailed Jan. 27, 2010, for U.S. Appl. No. 11/428,522, filed Jul. 3, 2006, five pages.
- Notice of Allowability mailed Sep. 2, 2009, for U.S. Appl. No. 11/428,506, filed Jul. 3, 2006, five pages.
- Rubine, D.H. (Dec. 1991). "The Automatic Recognition of Gestures," CMU-CS-91-202, Submitted in Partial Fulfillment of the Requirements of the Degree of Doctor of Philosophy in Computer Science at Carnegie Mellon University, 285 pages.
- U.S. Appl. No. 10/654,108, filed Sep. 2, 2003 entitled "Ambidextrous Mouse".
- U.S. Appl. No. 10/789,676, filed Feb. 27, 2004 entitled "Shape Detecting Input Device"
- "4-Wire Resistive Touchscreens" obtained from <http://www.touchscreens.com/intro-touchtypes-4resistive.html> generated Aug. 5, 2005.
- "5-Wire Resistive Touchscreens" obtained from <http://www.touchscreens.com/intro-touchtypes-resistive.html> generated Aug. 5, 2005.
- "A Brief Overview of Gesture Recognition" obtained from http://www.dai.ed.ac.uk/Cvonline/LOCA_COPIES/COHEN/gesture_overview.html, generated Apr. 20, 2004.
- "Capacitive Touchscreens" obtained from <http://www.touchscreens.com/intro-touchtypes-capacitive.html> generated Aug. 5, 2005.
- "Capacitive Position Sensing" obtained from <http://www.synaptics.com/technology/cps.cfm> generated Aug. 5, 2005.
- "Comparing Touch Technologies" obtained from <http://www.touchscreens.com/intro-touchtypes.html> generated Oct. 10, 2004.
- "GlidePoint®" obtained from http://www.cirque.com/technology/technology_gp.html generated Aug. 5, 2005.
- "How do touchscreen monitors know where you're touching?" obtained from <http://www.electronics.howstuffworks.com/question716.html> generated Aug. 5, 2005.
- "How does a touchscreen work?" obtained from <http://www.touchscreens.com/intro-anatomy.html> generated Aug. 5, 2005.
- "Infrared Touchscreens" obtained from <http://www.touchscreens.com/intro-touchtypes-infrared.html> generated Aug. 5, 2005.
- "Mouse Emulation" FingerWorks obtained from http://www.fingerworks.com/gesture_guide_mouse.html generated Aug. 30, 2005.
- "Mouse Gestures in Opera" obtained from <http://www.opera.com/products/desktop/mouse/index.dml> generated Aug. 30, 2005.
- "Mouse Gestures." Optim oz, May 21, 2004.
- "MultiTouch Overview" FingerWorks obtained from <http://www.fingerworks.com/multoverview.html> generated Aug. 30, 2005.
- "Near Field Imaging Touchscreens" obtained from <http://www.touchscreens.com/intro-touchtypes-nfi.html> generated Aug. 5, 2005.
- "PenTouch Capacitive Touchscreens" obtained from <http://www.touchscreens.com/intro-touchtypes-pentouch.html> generated Aug. 5, 2005.

US 7,812,828 B2

Page 5

- "Surface Acoustic Wave Touchscreens" obtained from <http://www.touchscreens.com/intro-touchtypes-saw.html> generated Aug. 5, 2005.
- "Symbol Commander" obtained from <http://www.sensiva.com/symbolcommander/>, generated Aug. 30, 2005.
- "Tips for Typing" FingerWorks http://www.fingerworks.com/mini_typing.html generated Aug. 30, 2005.
- "Touch Technologies Overview" 2001. 3M Touch Systems, Massachusetts.
- "Wacom Components—Technology" obtained from <http://www.wacom-components.com/english/tech.asp> generated on Oct. 10, 2004.
- "Watershed Algorithm" <http://rsb.info.nih.gov/ij/plugins/watershed.html> generated Aug. 5, 2005.
- "FingerWorks—Gesture Guide—Application Switching," obtained from http://www.fingerworks.com/gesture_guide_apps.html, generated on Aug. 27, 2004, 1-pg.
- "FingerWorks—Gesture Guide—Editing," obtained from http://www.fingerworks.com/gesture_guide_editing.html, generated on Aug. 27, 2004, 2-pgs.
- "FingerWorks—Gesture Guide—File Operations," obtained from http://www.fingerworks.com/gesture_guide_files.html, generated on Aug. 27, 2004, 1-pg.
- "FingerWorks—Gesture Guide—Text Manipulation," obtained from http://www.fingerworks.com/gesture_guide_text_manip.html, generated on Aug. 27, 2004, 2-pg.
- "FingerWorks—Gesture Guide—Tips and Tricks," obtained from http://www.fingerworks.com/gesture_guide_tips.html, generated Aug. 27, 2004, 2-pgs.
- "FingerWorks—Gesture Guide—Web," obtained from http://www.fingerworks.com/gesture_guide_web.html, generated on Aug. 27, 2004, 1-pg.
- "FingerWorks—Guide to Hand Gestures for USB Touchpads," obtained from http://www.fingerworks.com/igesture_userguide.html, generated Aug. 27, 2004, 1-pg.
- "FingerWorks—iGesture—Technical Details," obtained from http://www.fingerworks.com/igesture_tech.html, generated Aug. 27, 2004, 1-pg.
- "FingerWorks—The Only Touchpads with Ergonomic Full-Hand Resting and Relaxation!" obtained from <http://www.fingerworks.com/resting.html>, Copyright 2001, 1-pg.
- "FingerWorks—Tips for Typing on the Mini," obtained from http://www.fingerworks.com/mini_typing.html, generated on Aug. 27, 2004, 2-pgs.
- "iGesture Pad—the MultiFinger USB TouchPad with Whole-Hand Gestures," obtained from <http://www.fingerworks.com/igesture.html>, generated Aug. 27, 2004, 2-pgs.
- Bier, et al., "Toolglass and Magic Lenses: The see-through interface" In James Kijiyi, editor, *Computer Graphics (SIGGRAPH '93 Proceedings)*, vol. 27, pp. 73-80, Aug. 1993.
- Buxton, W. et al. (Jul. 22, 1985). "Issues and Techniques in Touch-Sensitive Tablet Input," *Proceedings ACM Siggraph*, pp. 215-224.
- Cutler, L.D. et al. (Apr. 27, 1997). "Two-Handed Direct Manipulation on the Responsive Workbench," *Proceedings of the 1997 Symposium on Interactive 3D Graphics*, Providence, RI, Apr. 27-30, 1997, pp. 107-114.
- Davis, J. et al. (Oct. 31, 1994). "Determining 3-D Hand Motion," *Signals, Systems and Computers, 1994 Conference Record of the 28th Asilomar Conference on Pacific Grove, CA*, Oct. 31-Nov. 2, 1994, Los Alamitos, CA, pp. 1262-1266.
- Douglas et al., *The Ergonomics of Computer Pointing Devices* (1997).
- European Search Report received in EP 1 621 989 (@ *Beyer Weaver & Thomas, LLP*) dated Mar. 27, 2006.
- EVB Elektronik "ISOP6238 IR Receiver Modules for Infrared Remote Control Systems" dated Jan. 2004 1-pg.
- Fisher et al., "Repetitive Motion Disorders: The Design of Optimal Rate—Rest Profiles," *Human Factors*, 35(2):283-304 (Jun. 1993).
- Fukumoto, et al., "ActiveClick: Tactile Feedback for Touch Panels," In *CHI 2001 Summary*, pp. 121-122, 2001.
- Fukumoto and Yoshinobu Tonomura, "Body Coupled Fingering: Wireless Wearable Keyboard," *CHI 97*, pp. 147-154 (Mar. 1997).
- Hardy, "Fingerworks" Mar. 7, 2002; BBC World On Line.
- Hillier and Gerald J. Lieberman, *Introduction to Operations Research* (1986).
- Jacob et al., "Integrality and Separability of Input Devices," *ACM Transactions on Computer-Human Interaction*, 1:3-26 (Mar. 1994).
- Kinkley et al., "Touch-Sensing Input Devices," in *CHI '99 Proceedings*, pp. 223-230, 1999.
- KIONX "KXP84 Series Summary Data Sheet" copyright 2005, dated Oct. 21, 2005, 4-pgs.
- Lee et al., "A Multi-Touch Three Dimensional Touch-Sensitive Tablet," in *CHI '85 Proceedings*, pp. 121-128, 2000.
- Lee, "A Fast Multiple-Touch-Sensitive Input Device," Master's Thesis, University of Toronto (1984).
- Lee, S.K. et al. (Apr. 1985). "A Multi-Touch Three Dimensional Touch-Sensitive Tablet," *Proceedings of CHI: ACM Conference on Human Factors in Computing Systems*, pp. 21-25.
- Matsushita et al., "HoloWall: Designing a Finger, Hand, Body and Object Sensitive Wall," In *Proceedings of UIST '97*, Oct. 1997.
- Pavlovic, V.I. et al. (Jul. 1997). "Visual Interpretation of Hand Gestures for Human-Computer Interaction: A Review," *IEEE Transactions on Pattern Analysis and Machine Intelligence* 19(7):677-695.
- Quantum Research Group "QT510 / QWheel™ Touch Slider IC" copyright 2004-2005, 14-pgs.
- Quek, "Unencumbered Gestural Interaction," *IEEE Multimedia*, 3:36-47 (Winter 1996).
- Radwin, "Activation Force and Travel Effects on Overexertion in Repetitive Key Tapping," *Human Factors*, 39(1):130-140 (Mar. 1997).
- Rekimoto "SmartSkin: An Infrastructure for Freehand Manipulation on Interactive Surfaces" *CHI 2002*, Apr. 20-25, 2002.
- Rekimoto et al., "ToolStone: Effective Use of the Physical Manipulation Vocabularies of Input Devices," In *Proc. of UIST 2000*, 2000.
- Rubine et al., "Programmable Finger-Tracking Instrument Controllers," *Computer Music Journal*, vol. 14, No. 1 (Spring 1990).
- Rutledge et al., "Force-To-Motion Functions for Pointing," *Human-Computer Interaction—INTERACT (1990)*
- Subatai Ahmad, "A Usable Real-Time 3D Hand Tracker," *Proceedings of the 28th Asilomar Conference on Signals, Systems and Computers—Part 2 (of 2)*, vol. 2 (Oct. 1994).
- Texas Instruments "TSC2003 / I2C Touch Screen Controller" Data Sheet SBAS 162, dated Oct. 2001, 20-pgs.
- Wellner, "The Digital Desk Calculators: Tangible Manipulation on a Desk Top Display" In *ACM UIST '91 Proceedings*, pp. 27-34, Nov. 1991.
- Williams, "Applications for a Switched-Capacitor Instrumentation Building Block" *Linear Technology Application Note 3*, Jul. 1985, pp. 1-16.
- Yamada et al., "A Switched-Capacitor Interface for Capacitive Pressure Sensors" *IEEE Transactions on Instrumentation and Measurement*, vol. 41, No. 1, Feb. 1992, pp. 81-86.
- Yeh et al., "Switched Capacitor Interface Circuit for Capacitive Transducers" 1985 IEEE
- Zhai et al., "Dual Stream Input for Pointing and Scrolling," *Proceedings of CHI '97 Extended Abstracts (1997)*.
- Zimmerman et al., "Applying Electric Field Sensing to Human-Computer Interfaces," In *CHI '85 Proceedings*, pp. 280-287, 1995.
- International Search Report received in corresponding PCT application No. PCT/US2006/008349 dated Oct. 6, 2006.
- International search report for PCT/US99/01454, mailed May 14, 1999.
- European supplementary search report for European Patent Application No. 99904228.6, mailed Feb. 16, 2005.
- Supplementary European search report for U.S. Appl. No. 99904228.6, mailed Jul. 8, 2005.
- European examination report for European patent Application No. 99904228.6, mailed Apr. 20, 2006.
- European examination report for European Patent Application No. 99904228.6, mailed Mar. 23, 2007.
- Extended European search report for European Patent Application No. 06016858.0, mailed Dec. 21, 2007.
- Extended European search report for European Patent Application No. 06016856.4, mailed Mar. 14, 2008.
- European examination report for European Patent Application No. 06016830.9, mailed Aug. 6, 2008.

Copy provided by USPTO from the PIRS Image Database on 10/18/2010

750-Apple0000066

A569

JX-003.006

US 7,812,828 B2

Page 6

European search report for European Patent Application No. 06016830.9 mailed Dec 3, 2007.
European examination report for European Patent Application No. 06016856.4 mailed Sep. 16, 2008
Notice of Allowance mailed Mar. 23, 2010, for U.S. Appl. No. 11/428,501, filed Jul. 3, 2006, eight pages.
European Search Report mailed Feb. 17, 2010, for EP Application No. 06016857.2, six pages.
European Search Report mailed Feb. 24, 2010, for EP Application No. 06016833.3, nine pages.

Sun Microsystems. (1992). "The Star7 PDA Prototype." located at <<http://www.youtube.com/watch?v=Ahg8OBYixL0>, last visited Jan. 15, 2010, seven pages.

Tomita, A. Jr. et al. (Nov. 9, 1997). "An Image Processing Method for Use in a GUI for the Visually Impaired," *Proceedings of the IECON '97: 23rd International Conference on Industrial Electronics, Control and Instrumentation*, New Orleans, LA, Nov. 9-14, 1997, pp. 264-268.

* cited by examiner

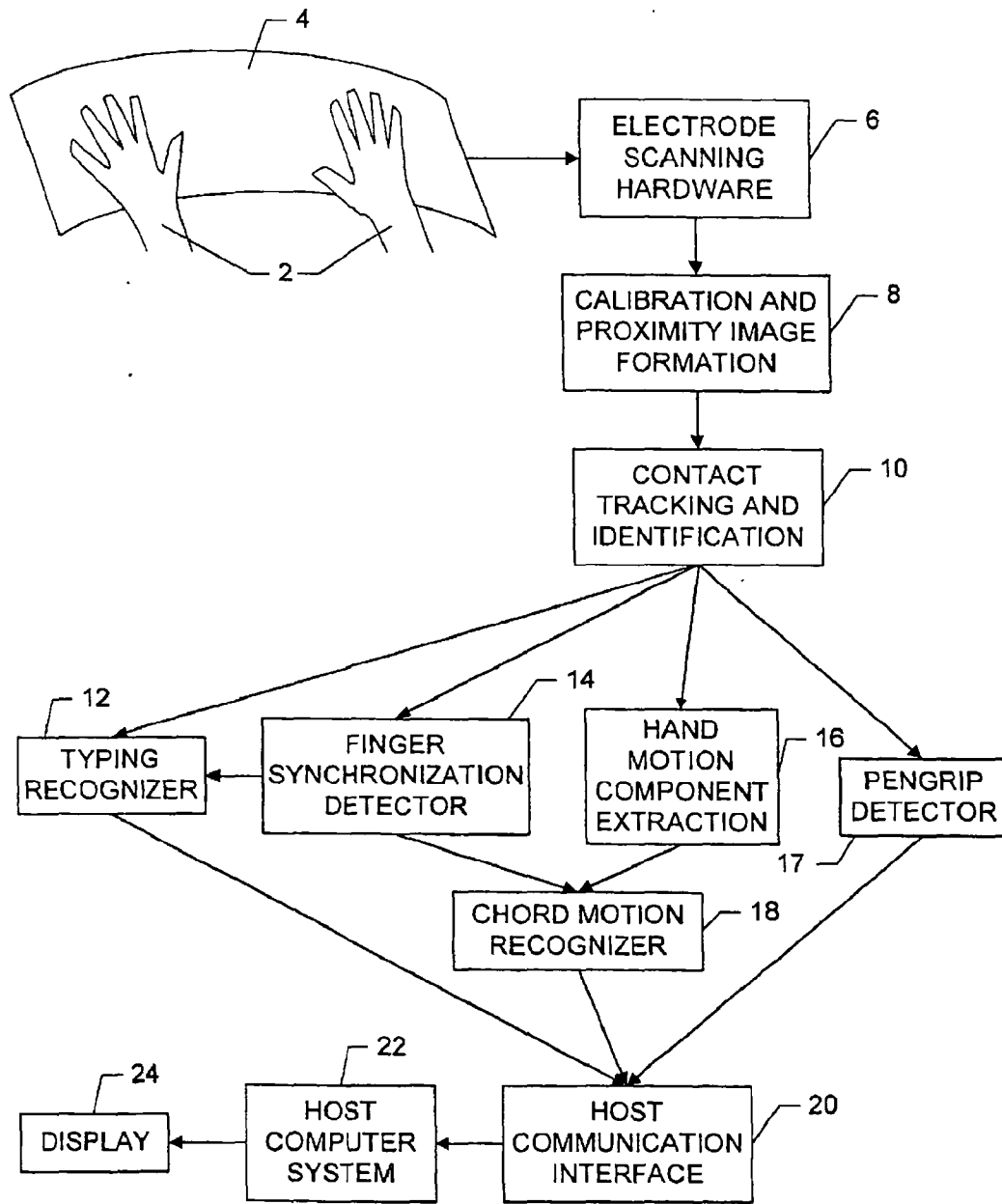

FIG. 1

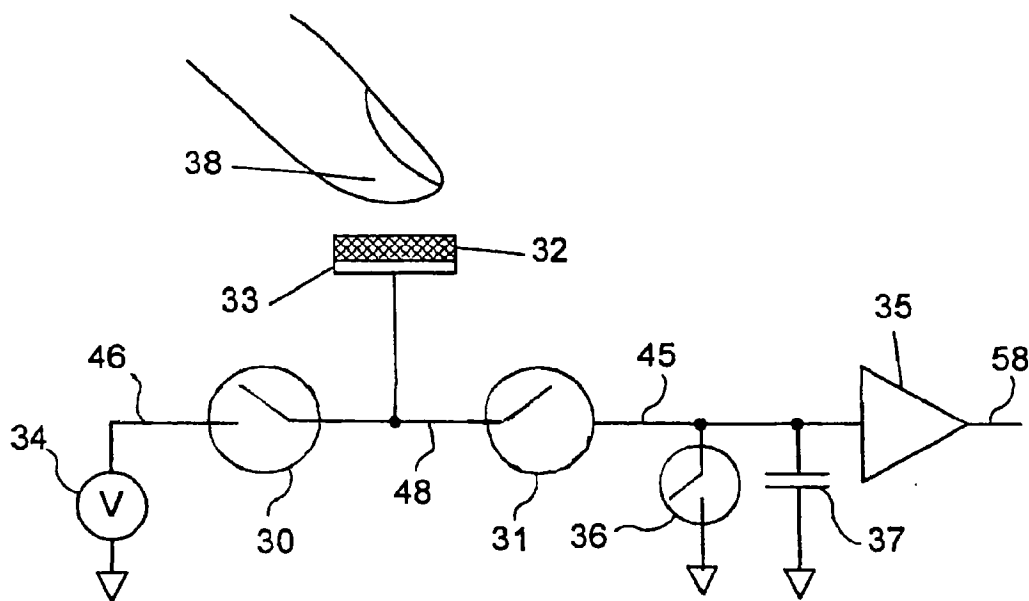

FIG. 2

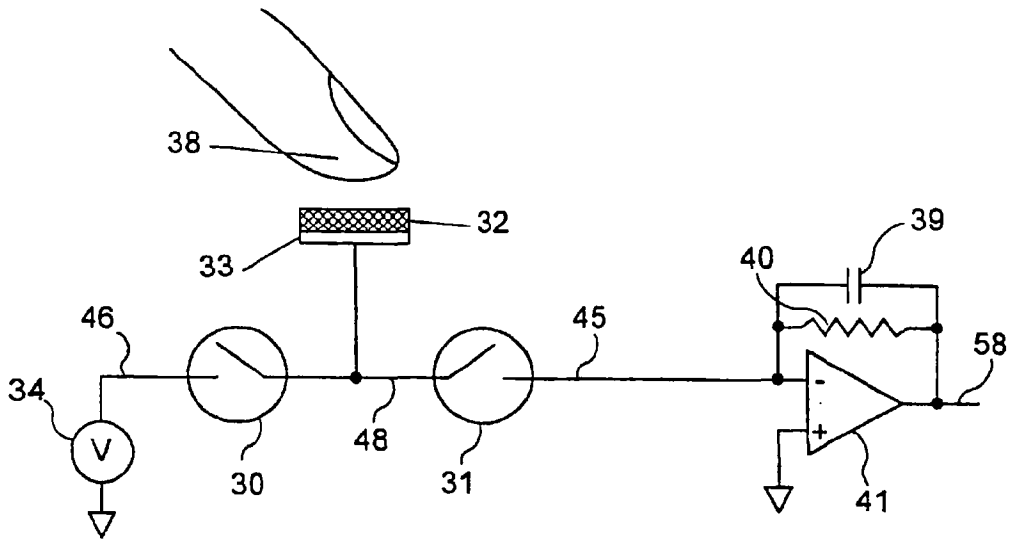

FIG. 3A

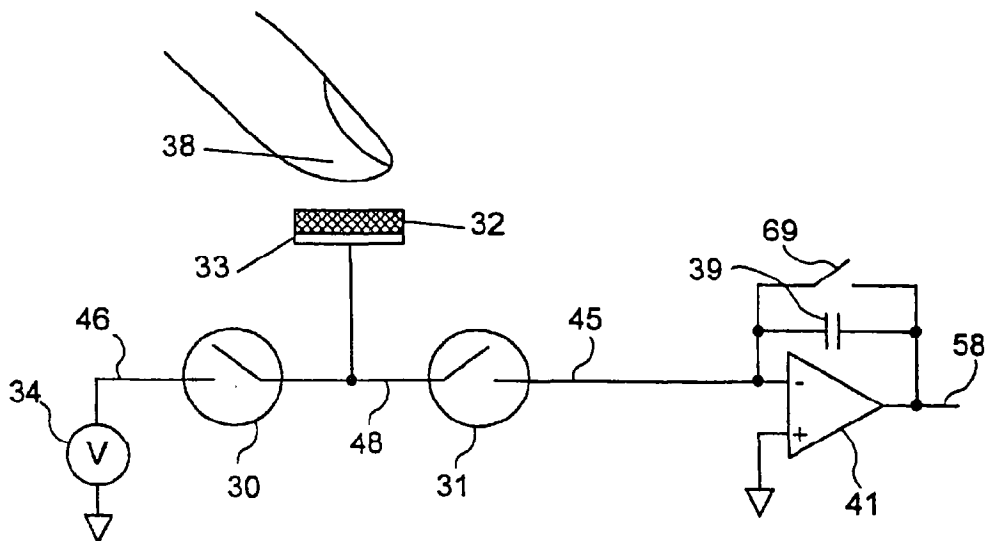

FIG. 3B

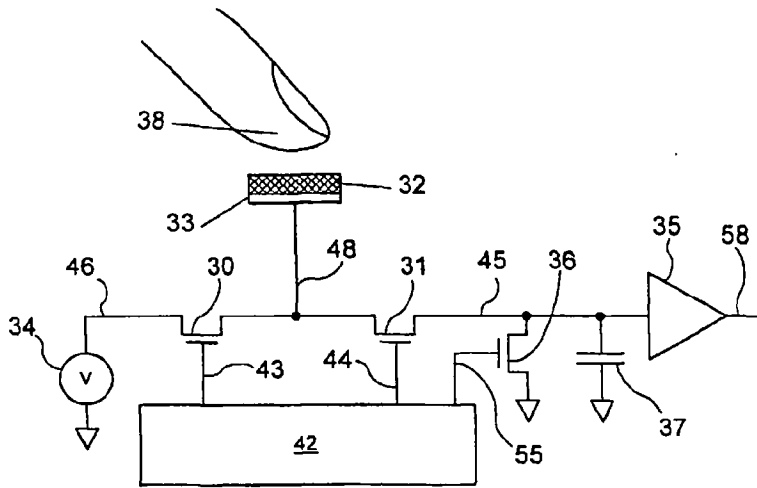

FIG. 4A

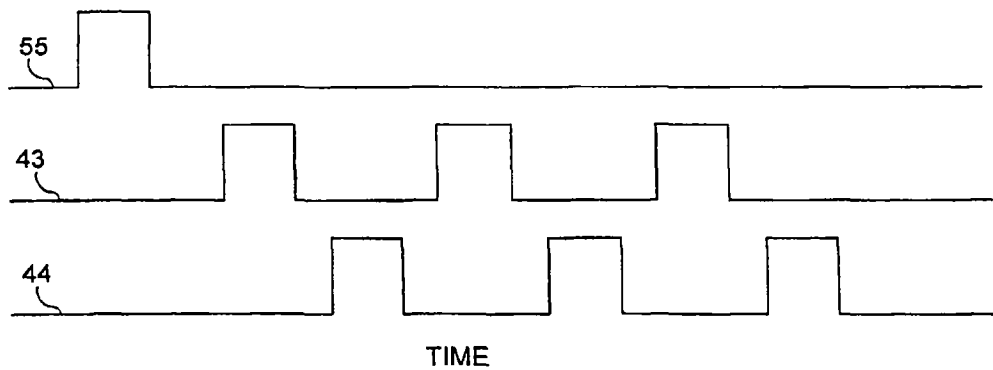

FIG. 4B

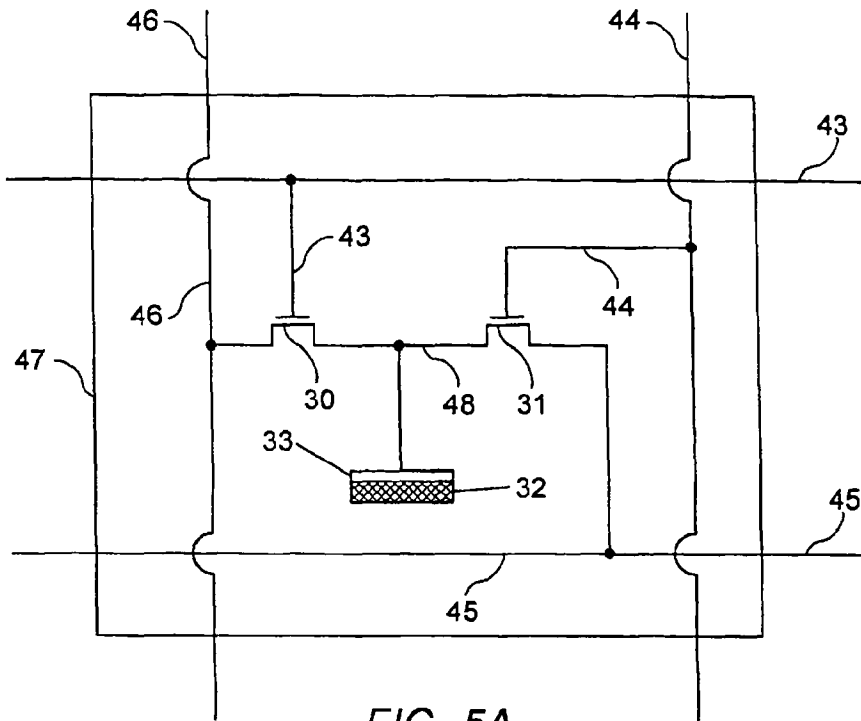

FIG. 5A

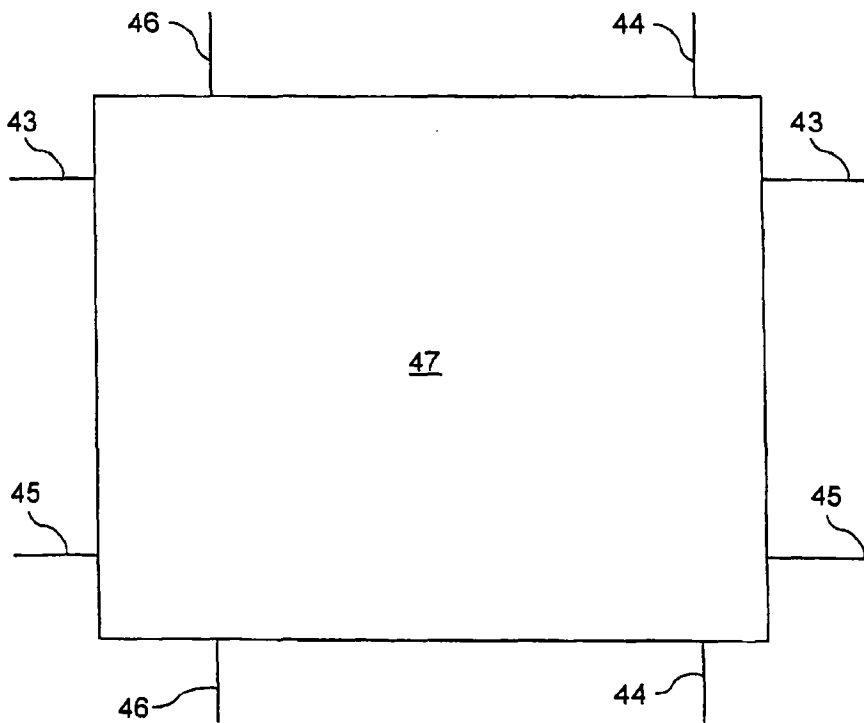

FIG. 5B

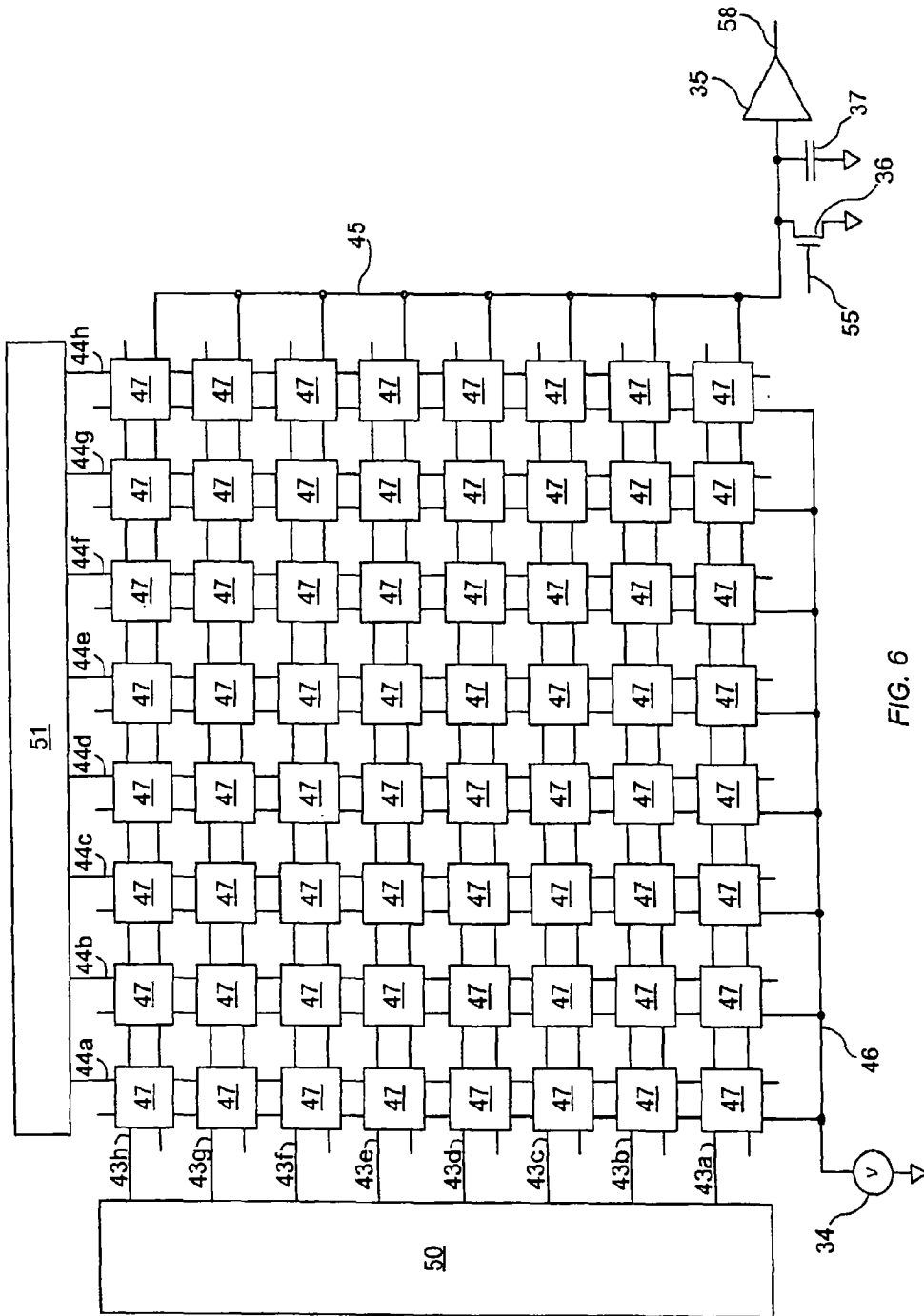

FIG. 6

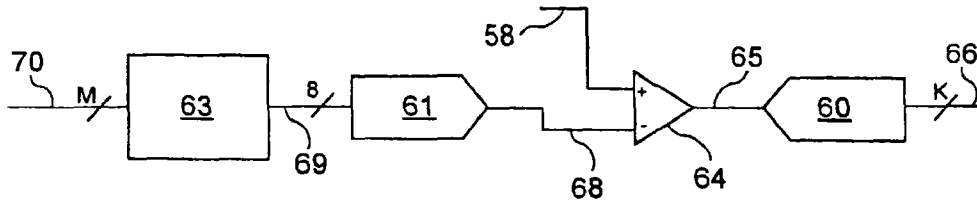

FIG. 7A

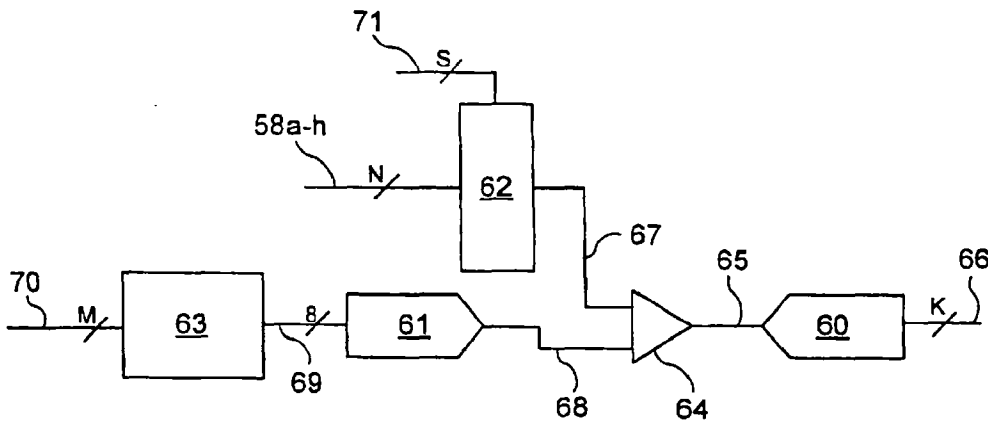

FIG. 7B

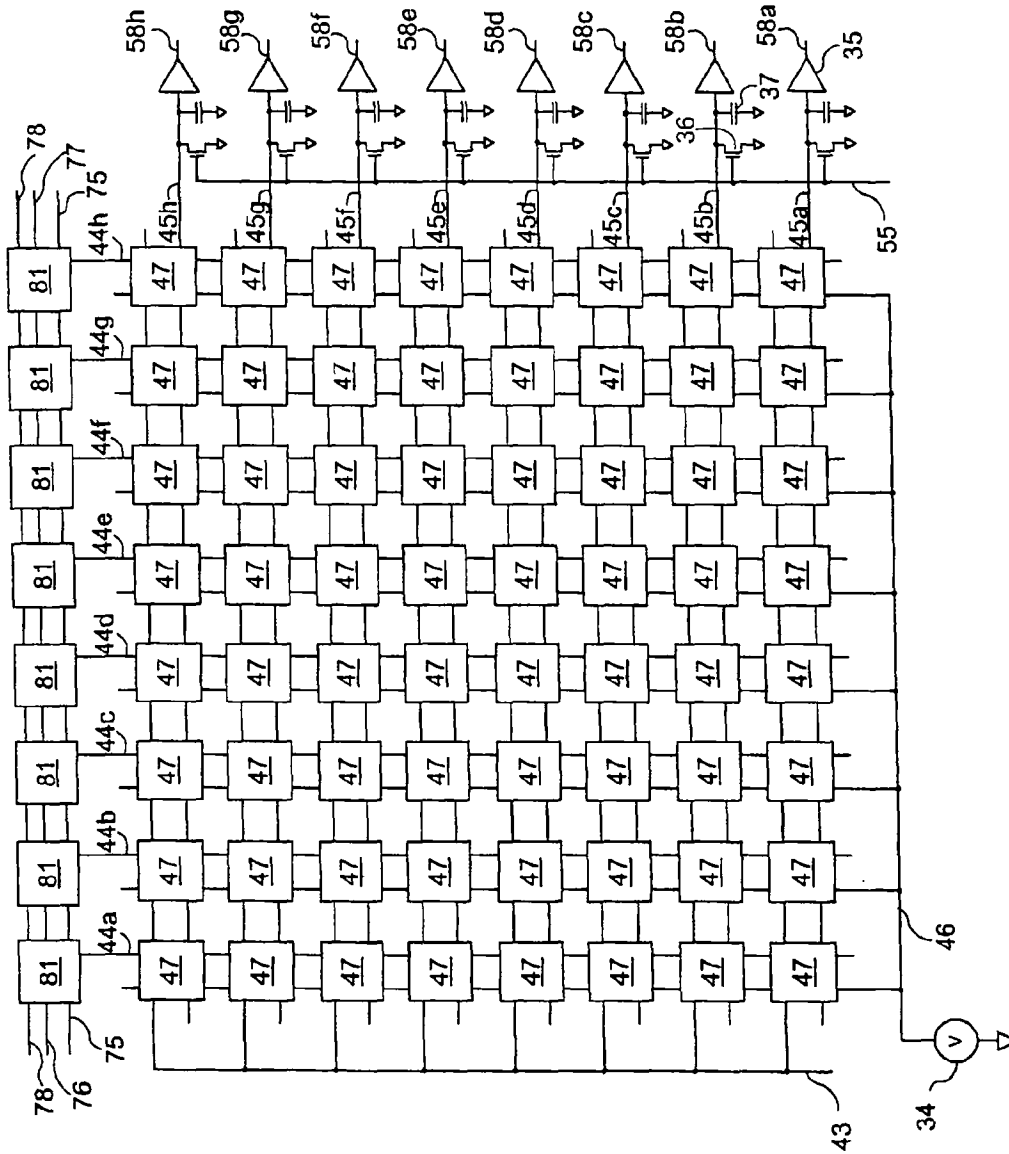
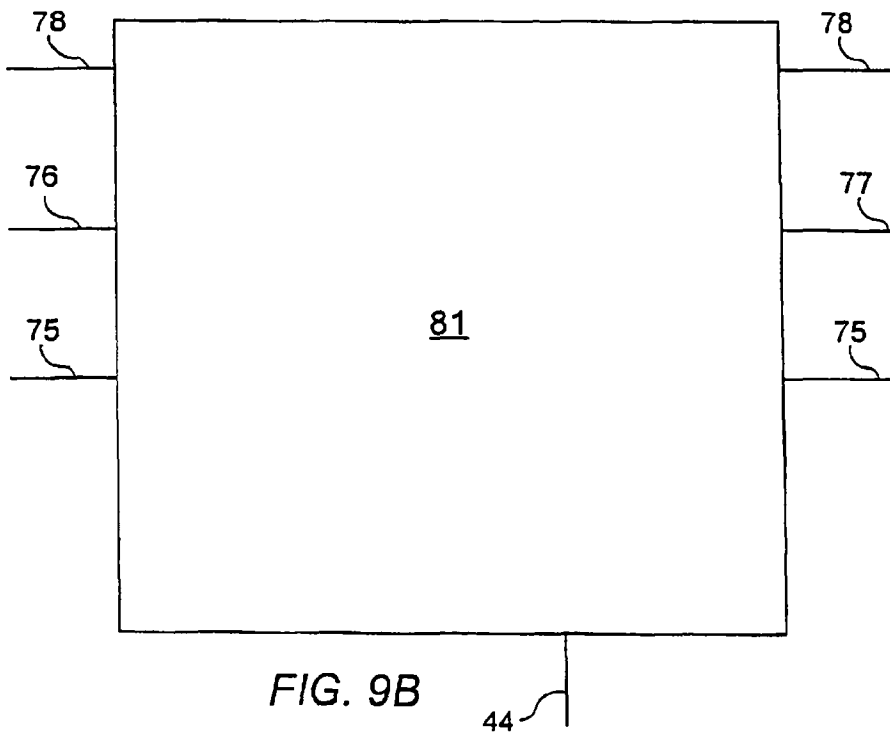
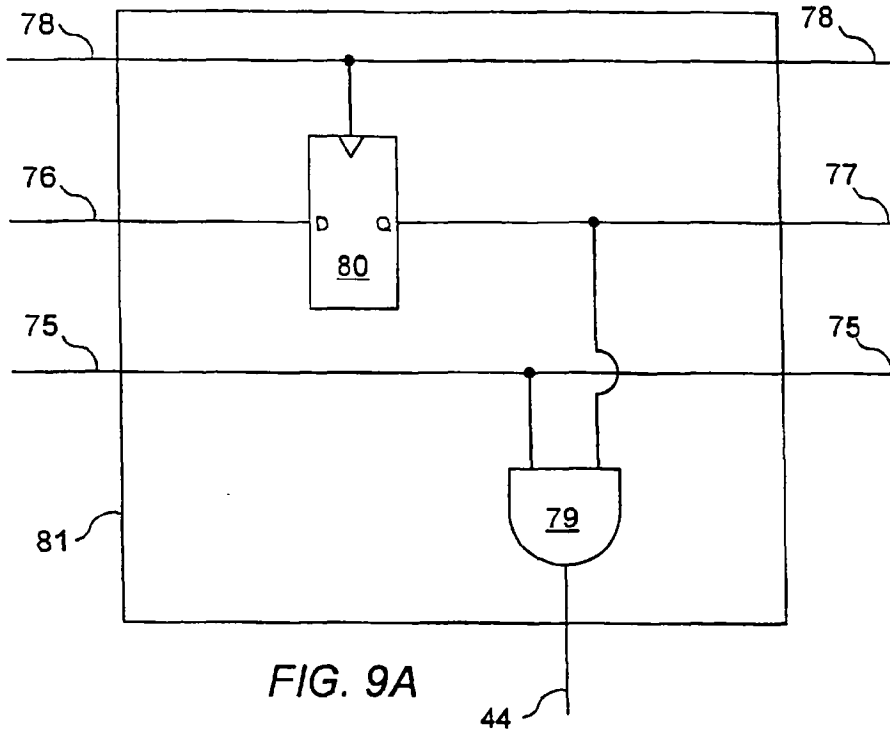

FIG. 8



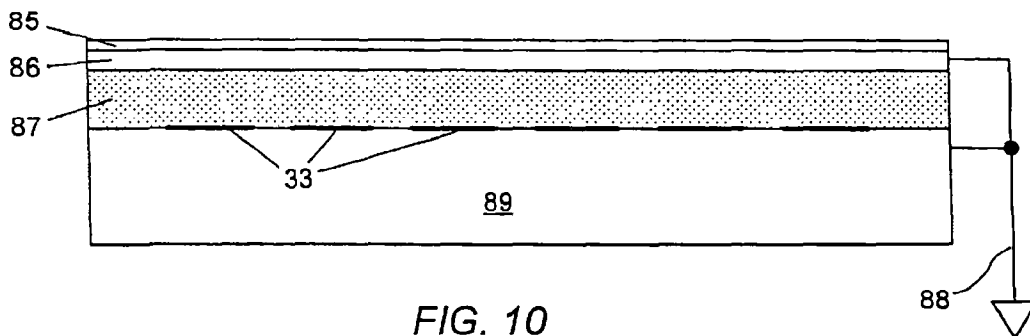

FIG. 10

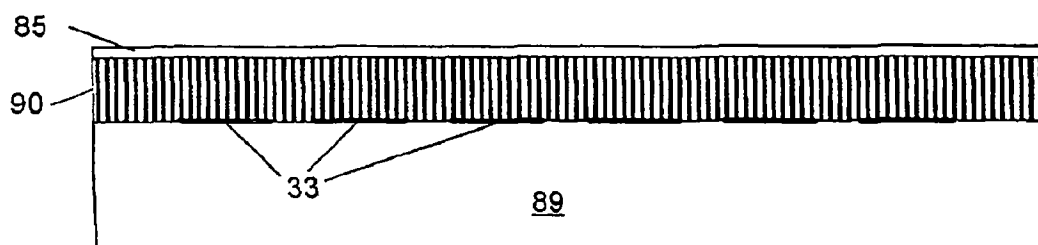

FIG. 11

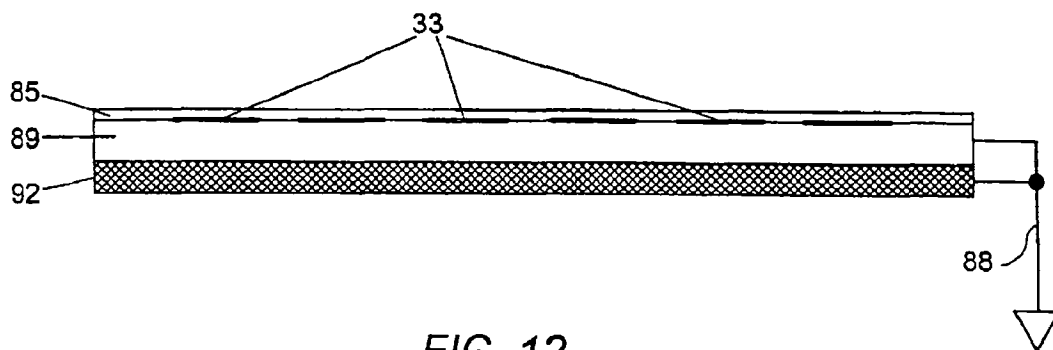

FIG. 12

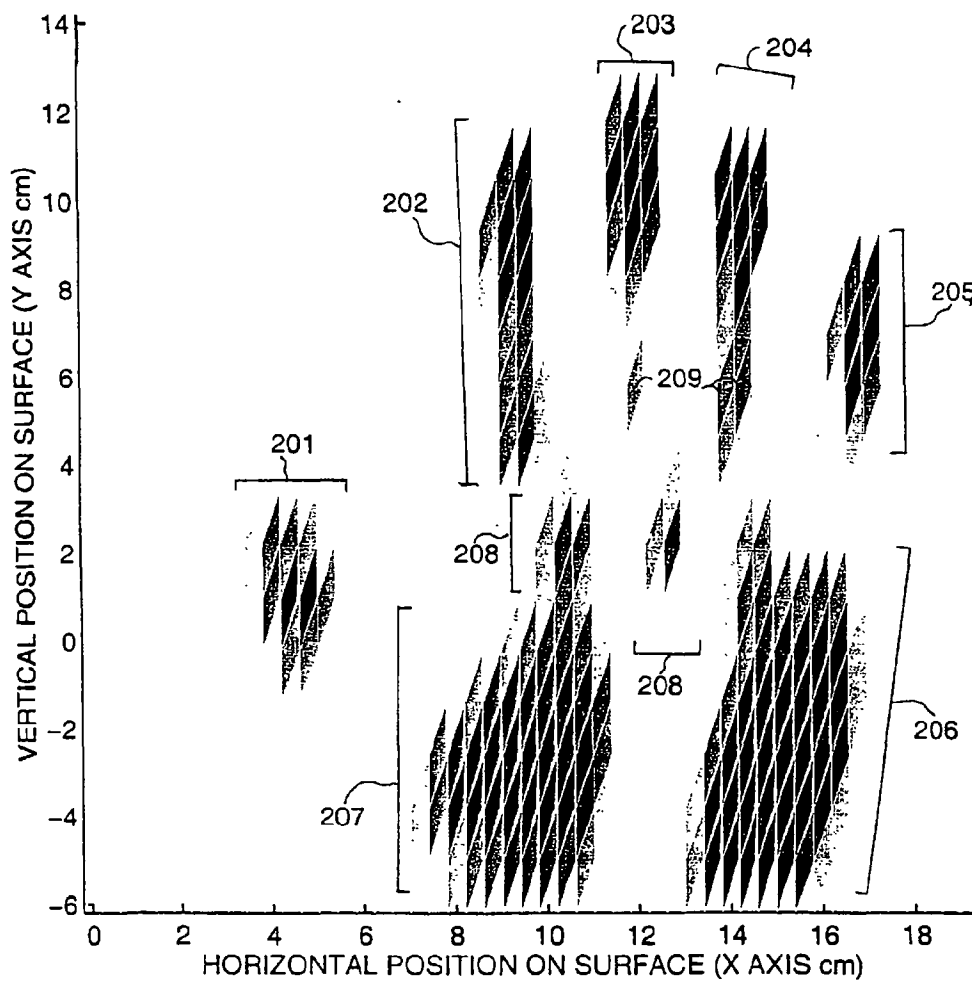

FIG. 13

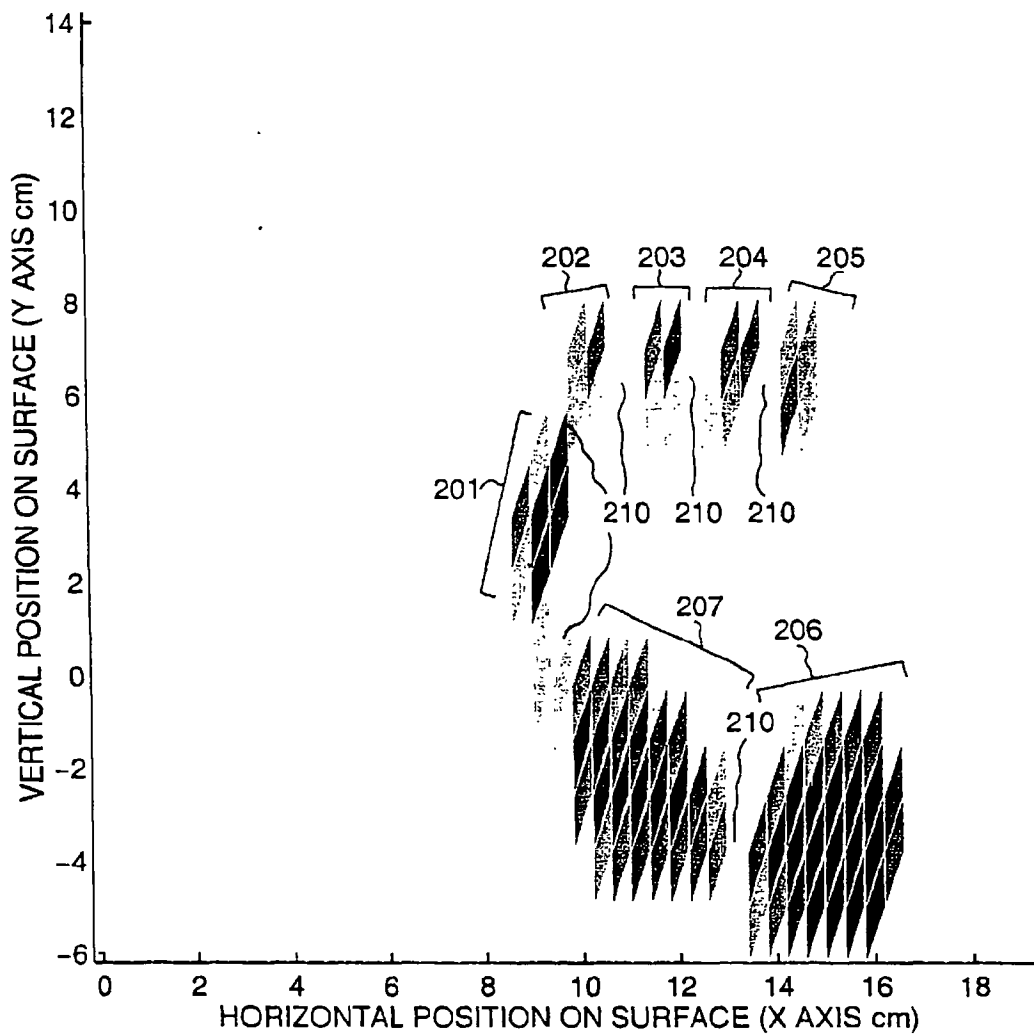

FIG. 14

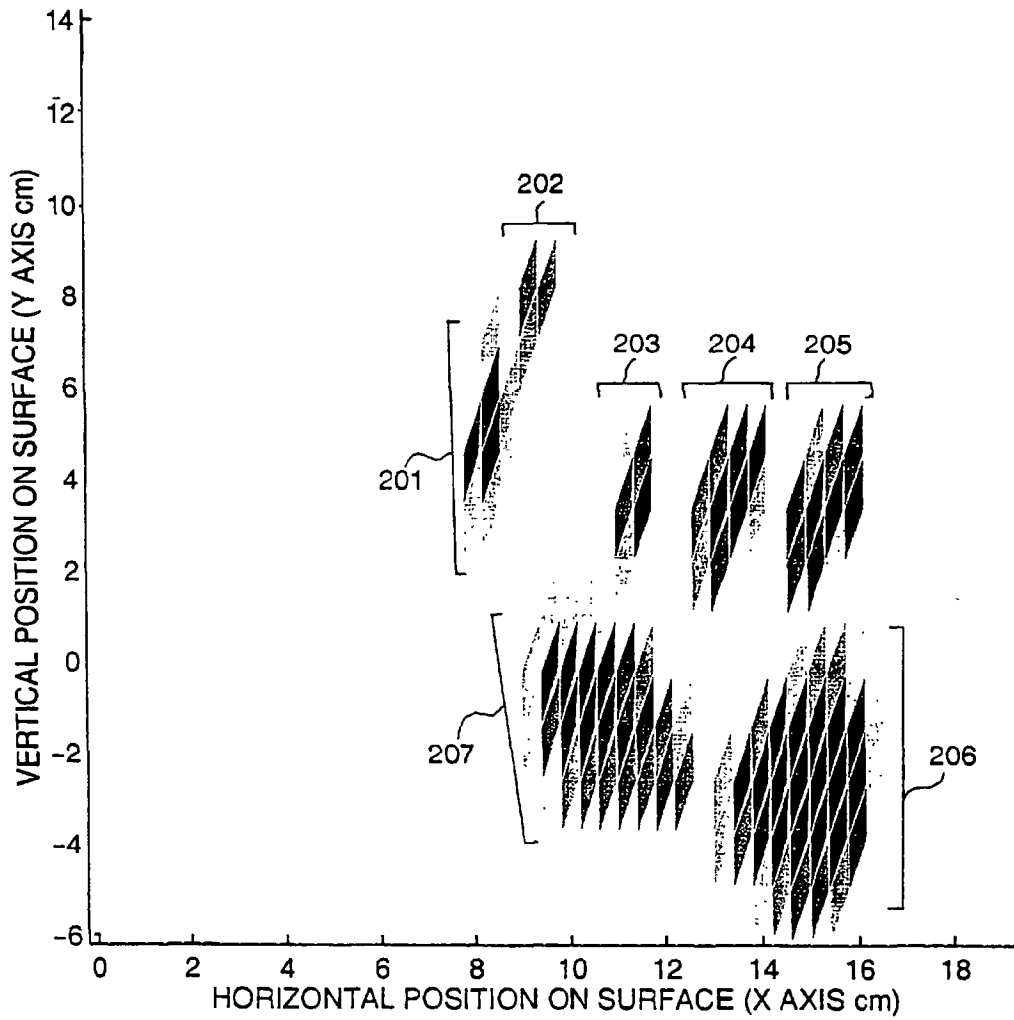

FIG. 15

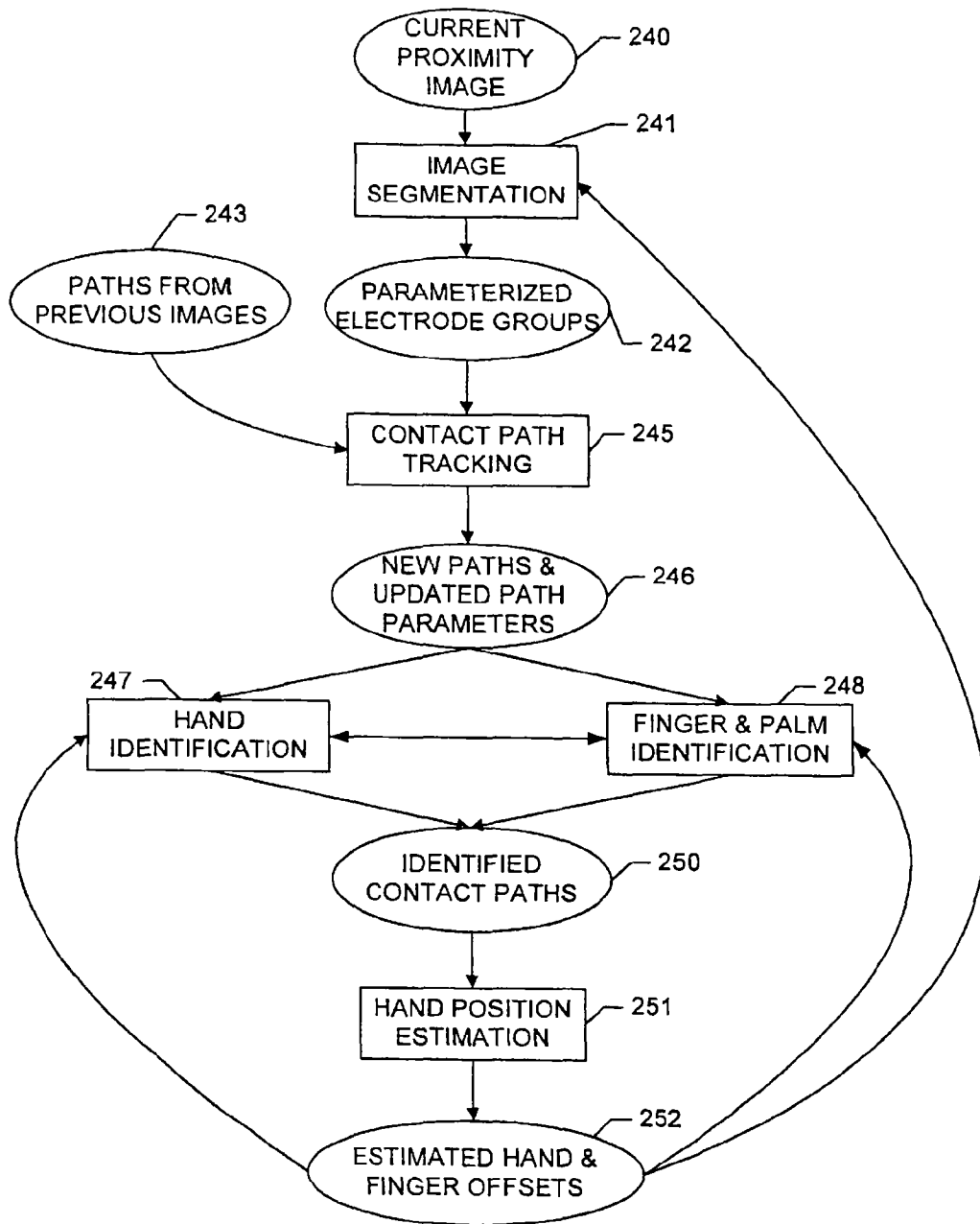

FIG. 16

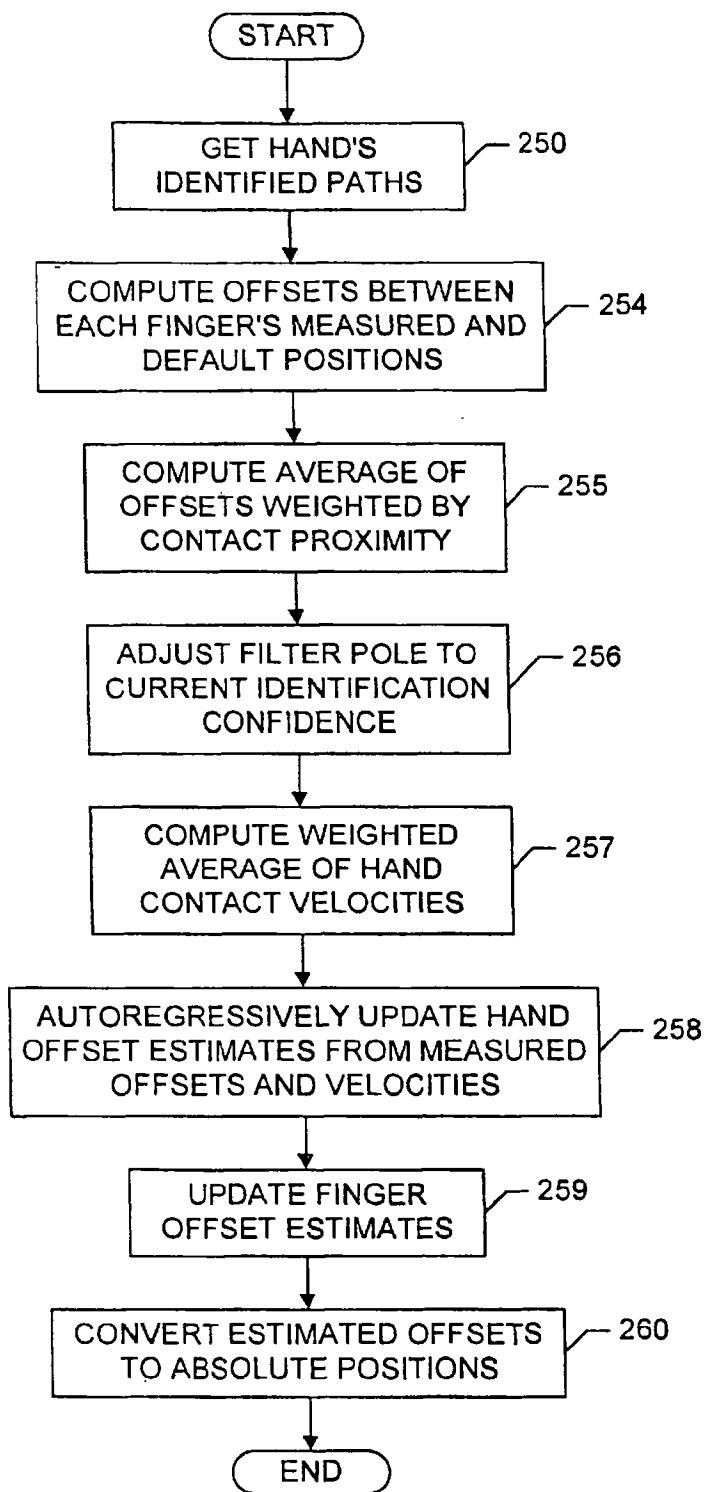

FIG. 17

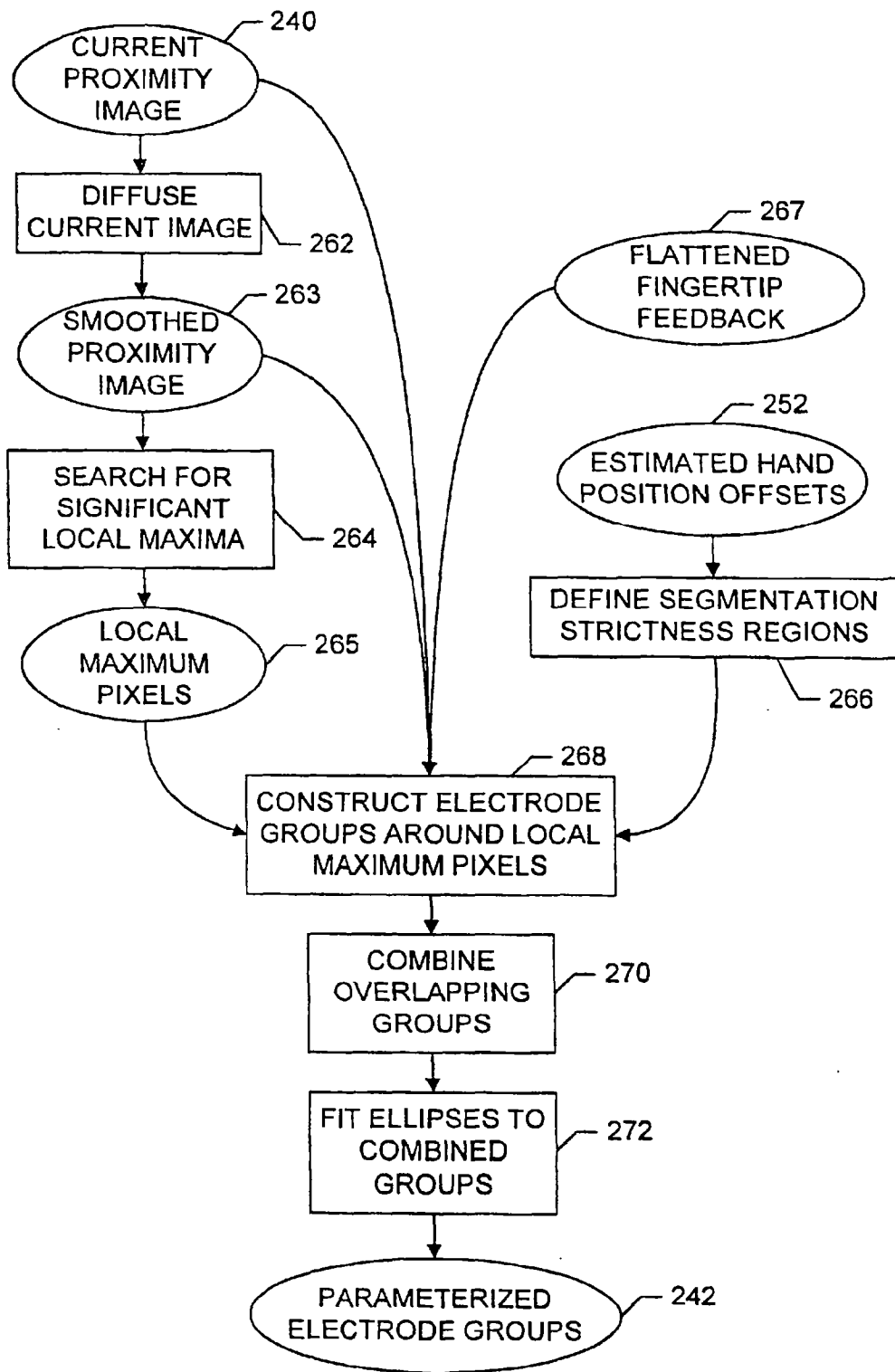

FIG. 18

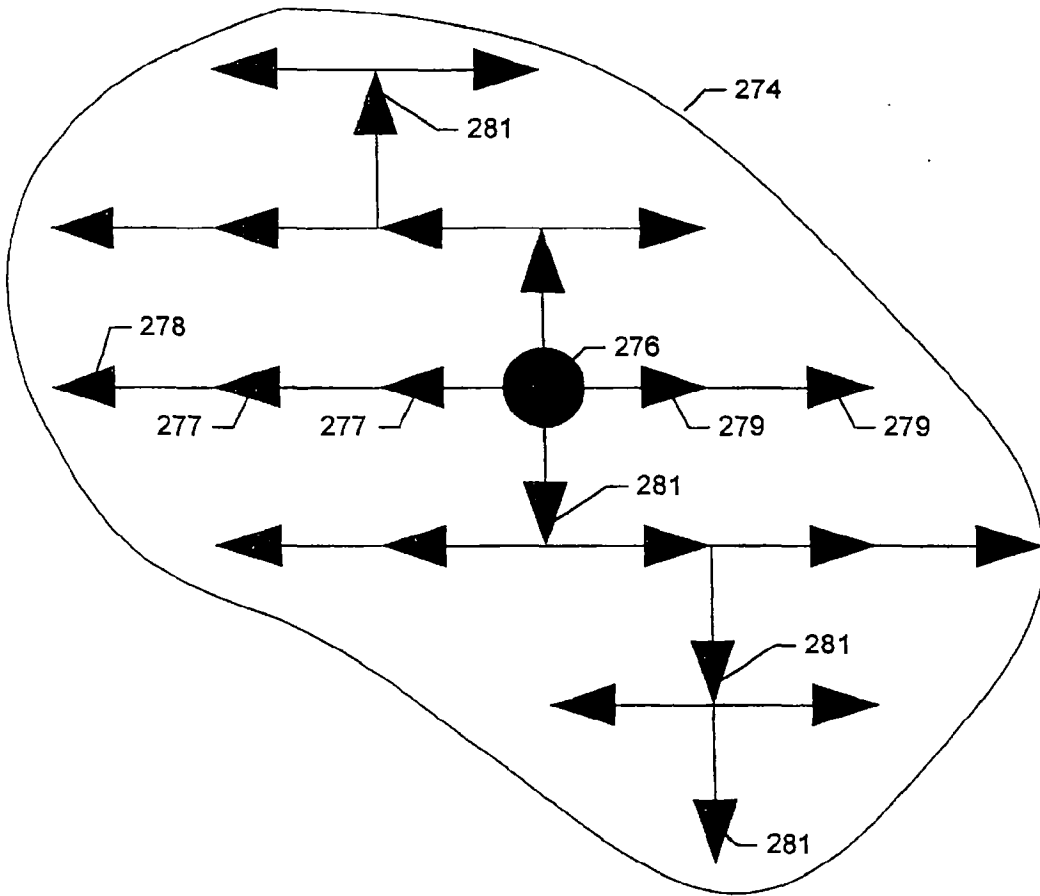

FIG. 19

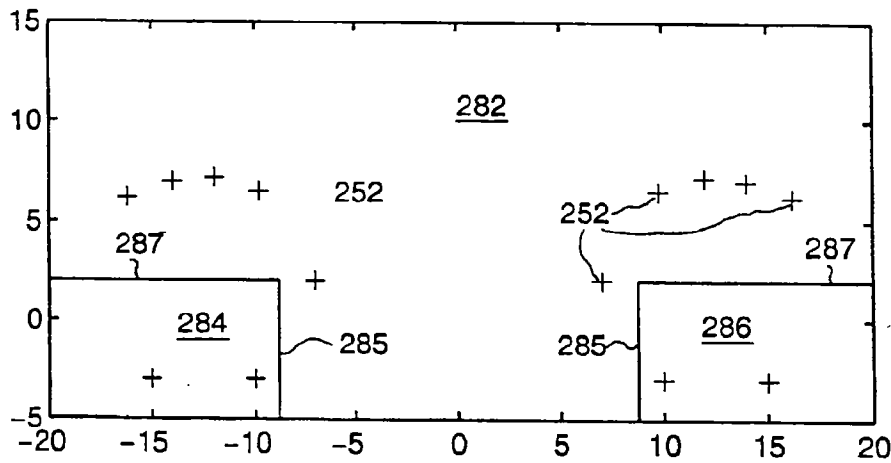

FIG. 20A

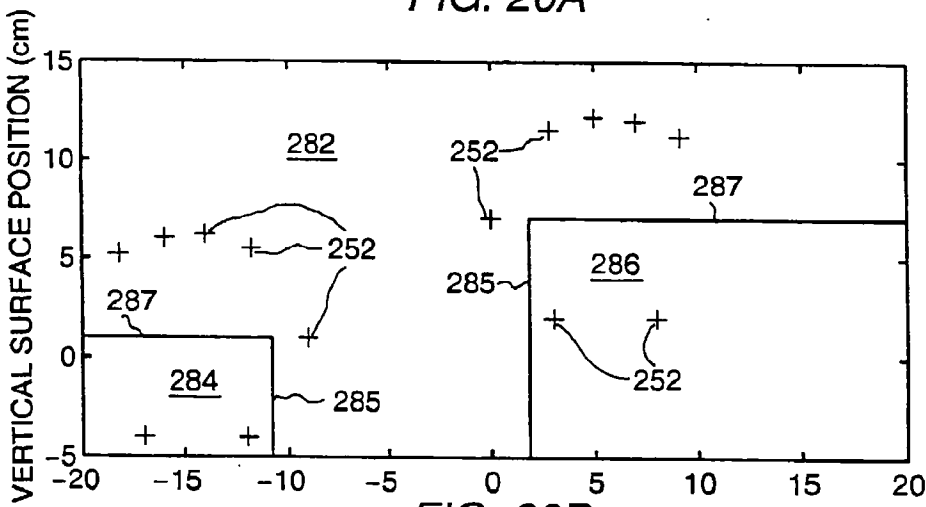

FIG. 20B

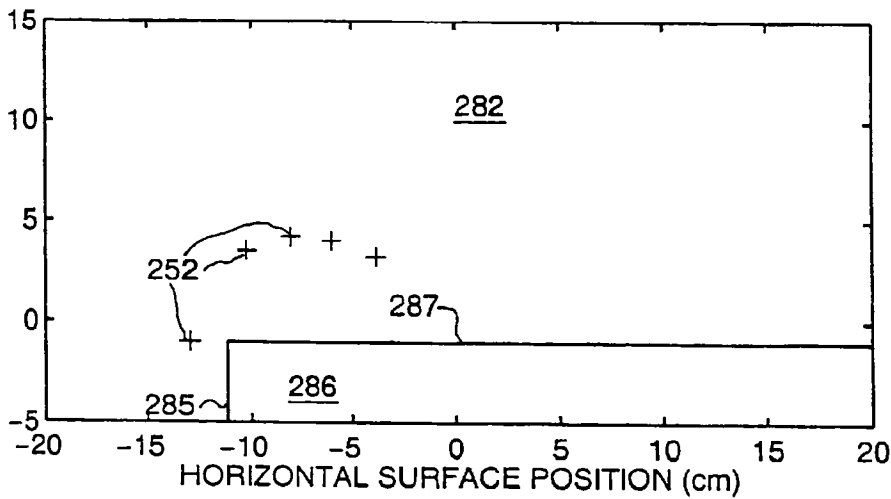

FIG. 20C

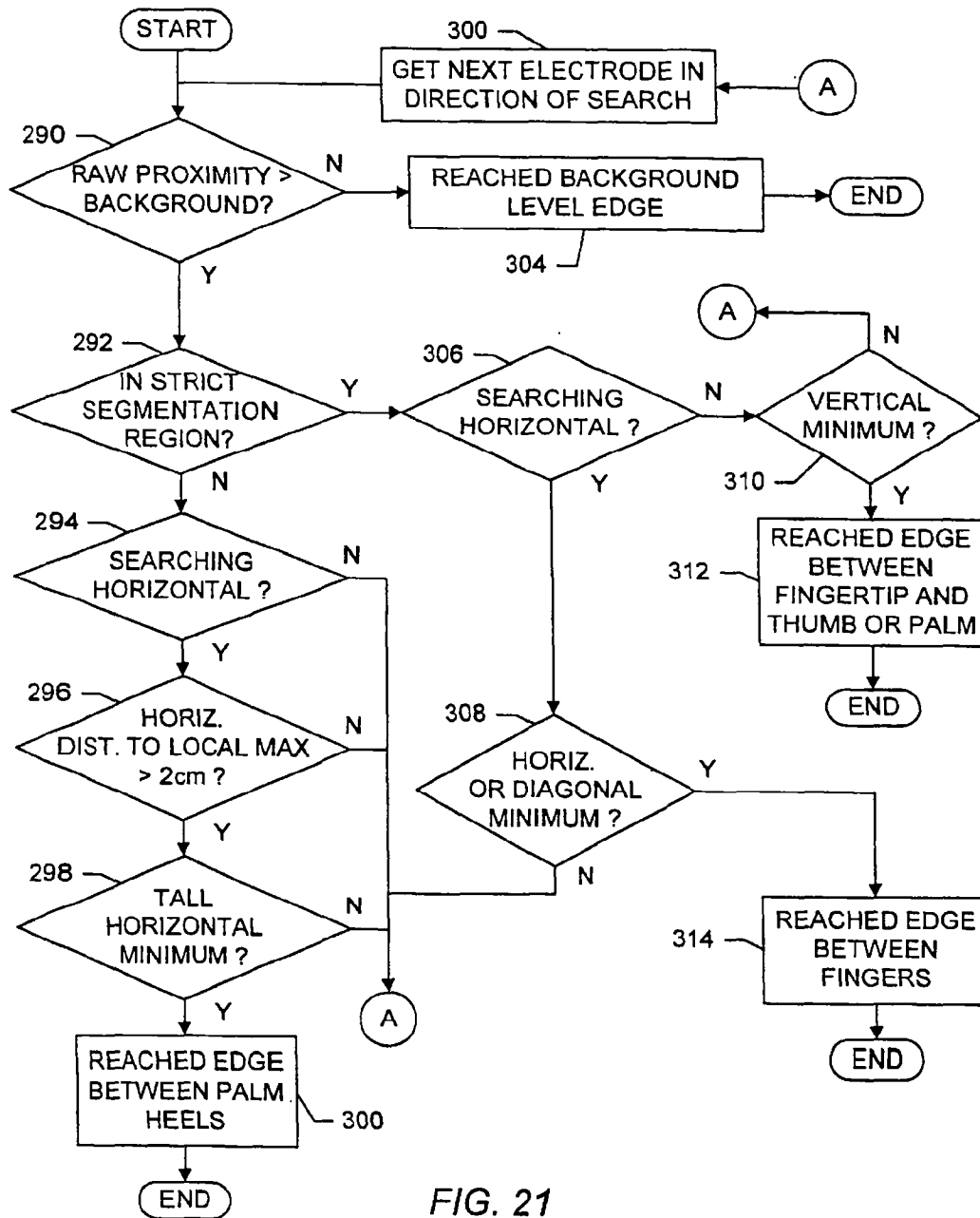

FIG. 21

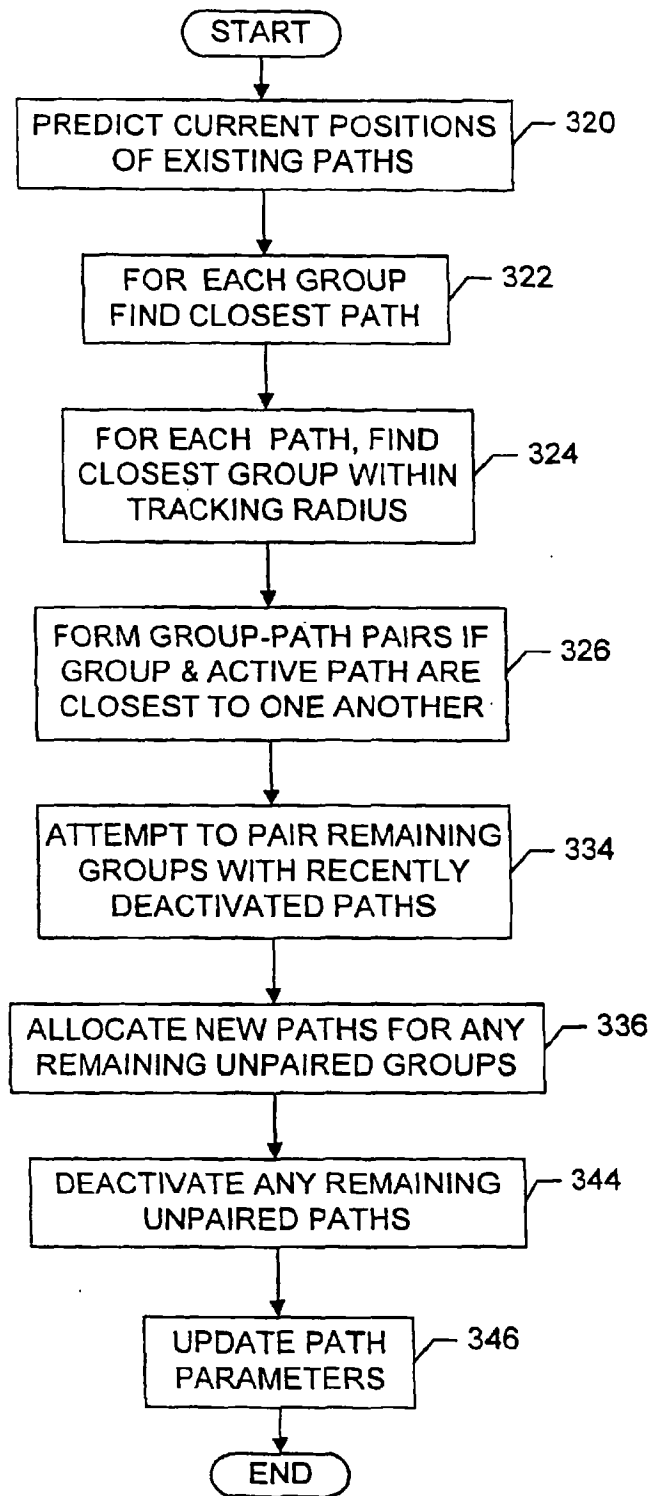

FIG. 22

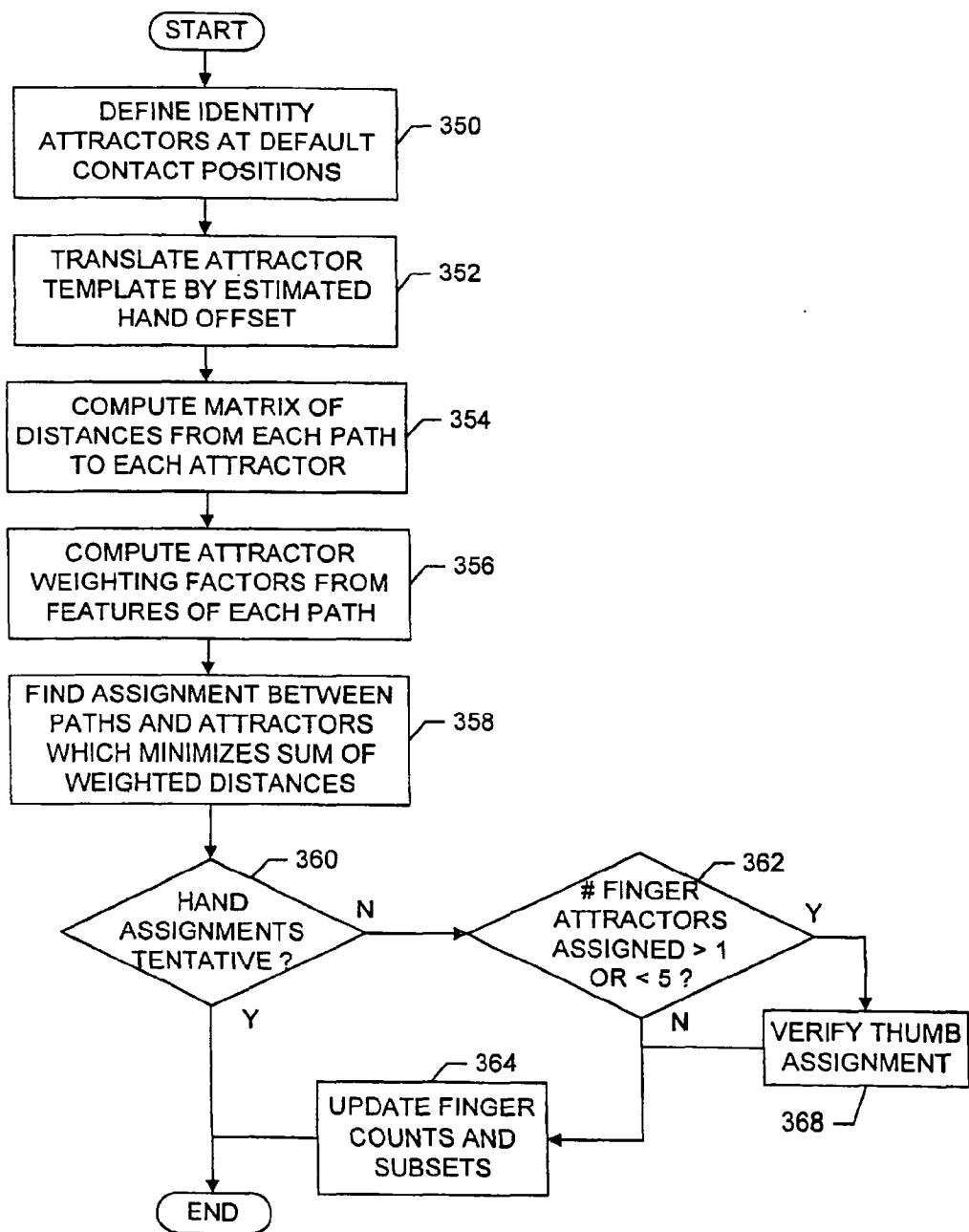

FIG. 23

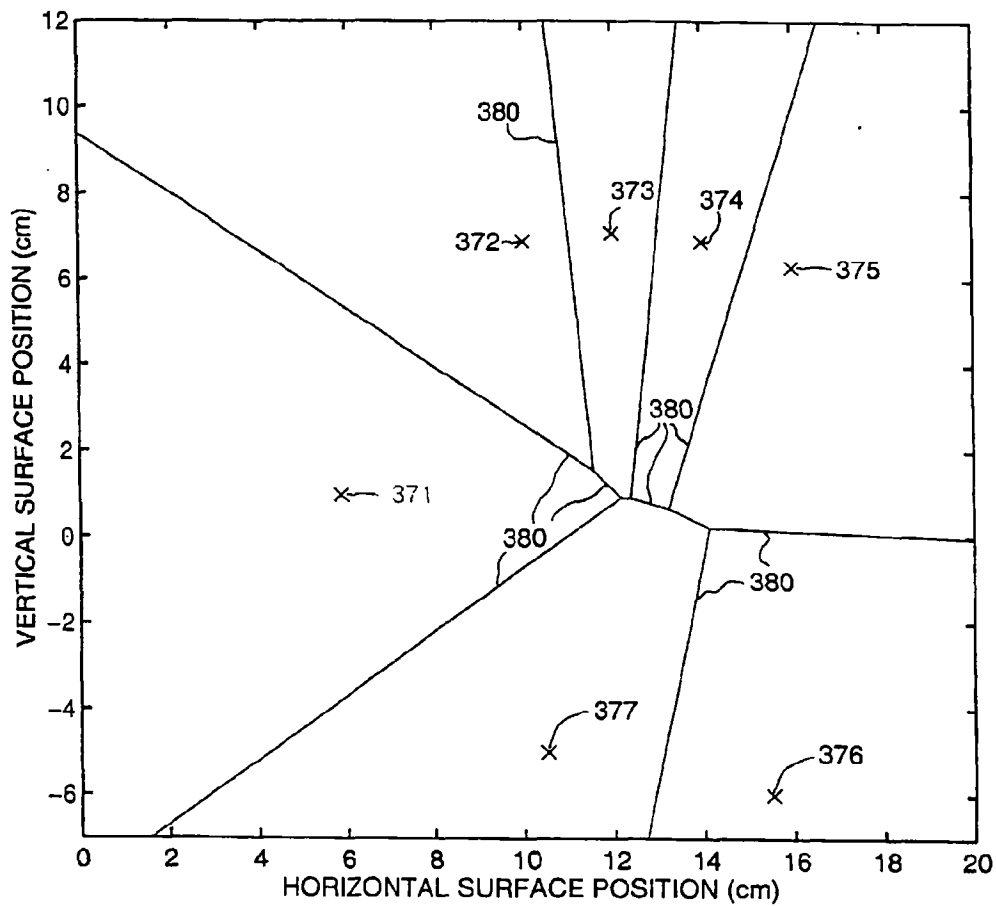

FIG. 24

U.S. Patent

Oct. 12, 2010

Sheet 25 of 45

US 7,812,828 B2

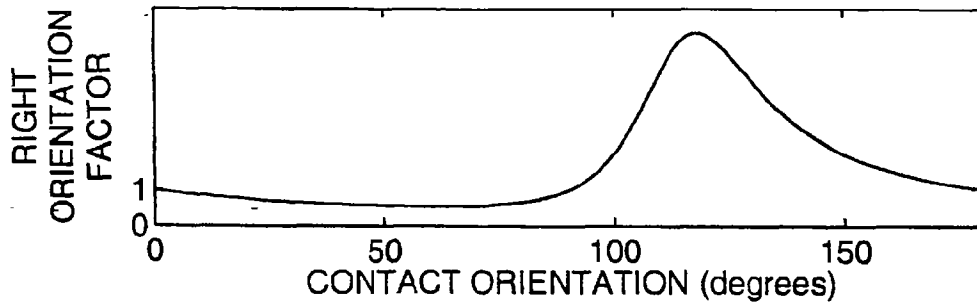

FIG. 25A

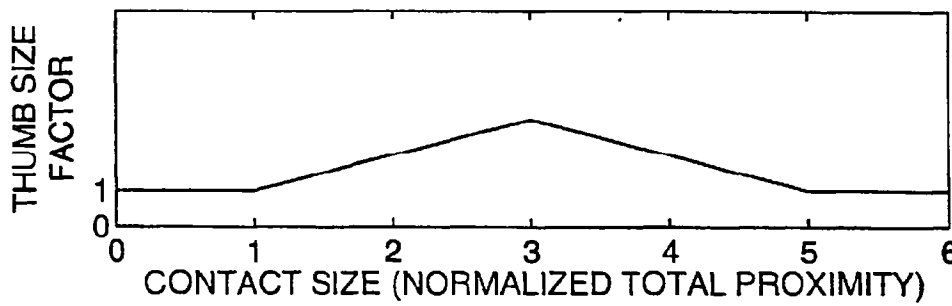

FIG. 25B

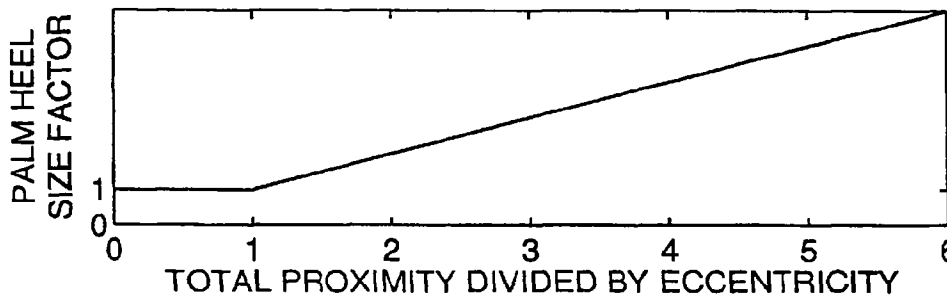

FIG. 25C

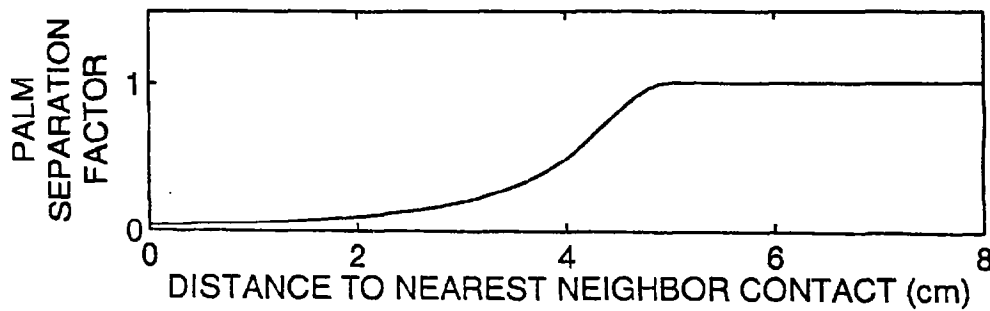

FIG. 25D

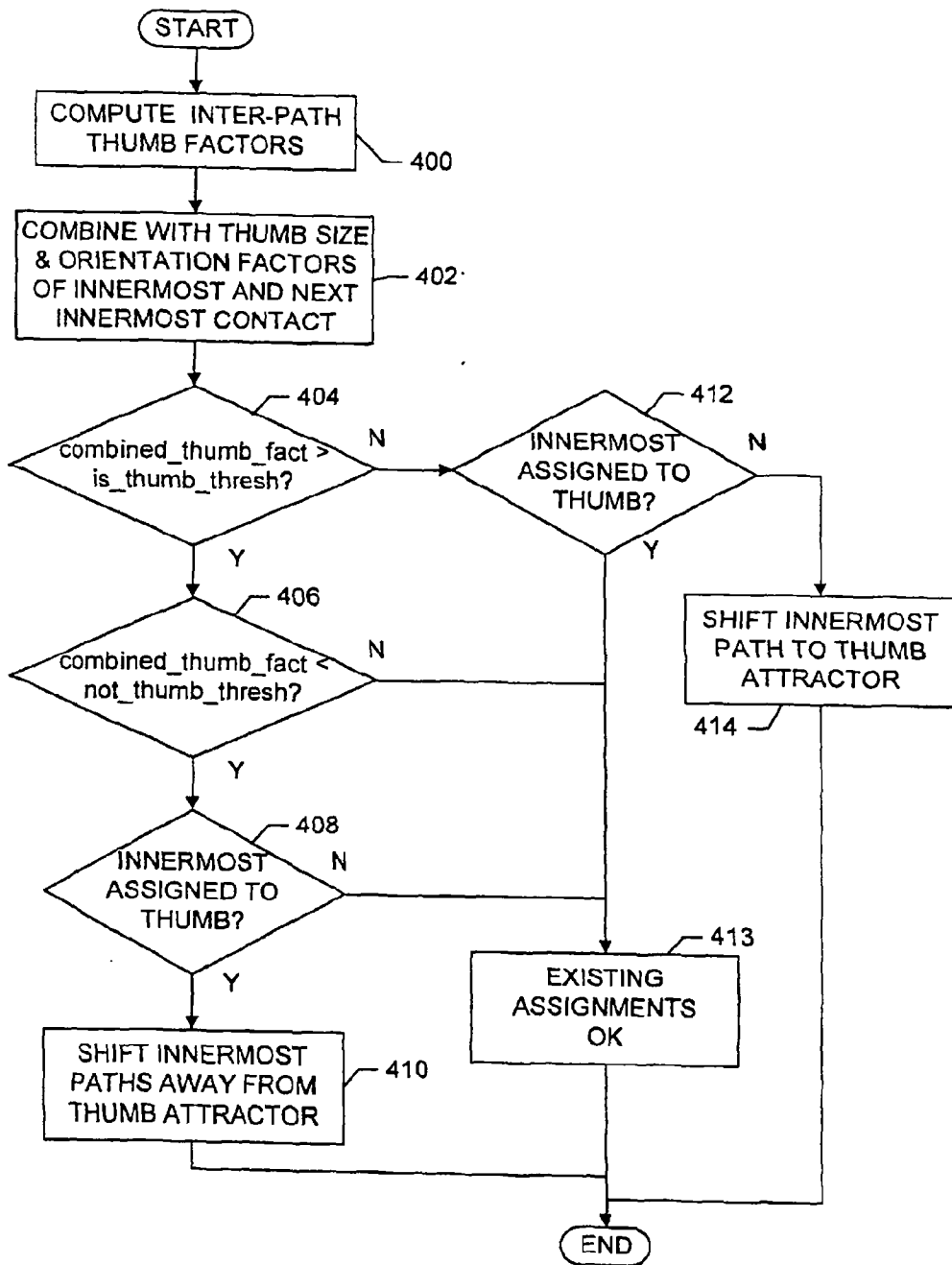

FIG. 26

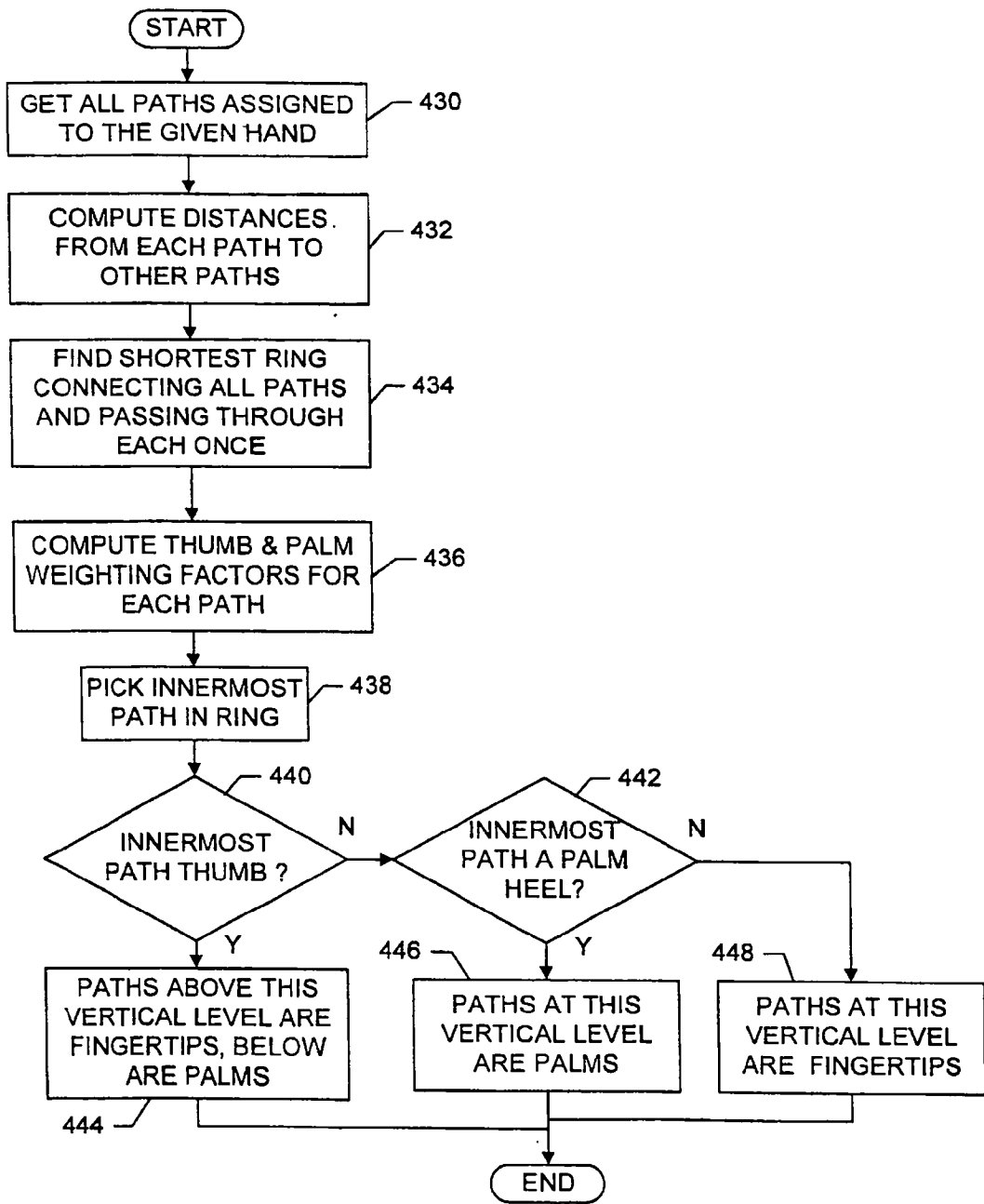

FIG. 27

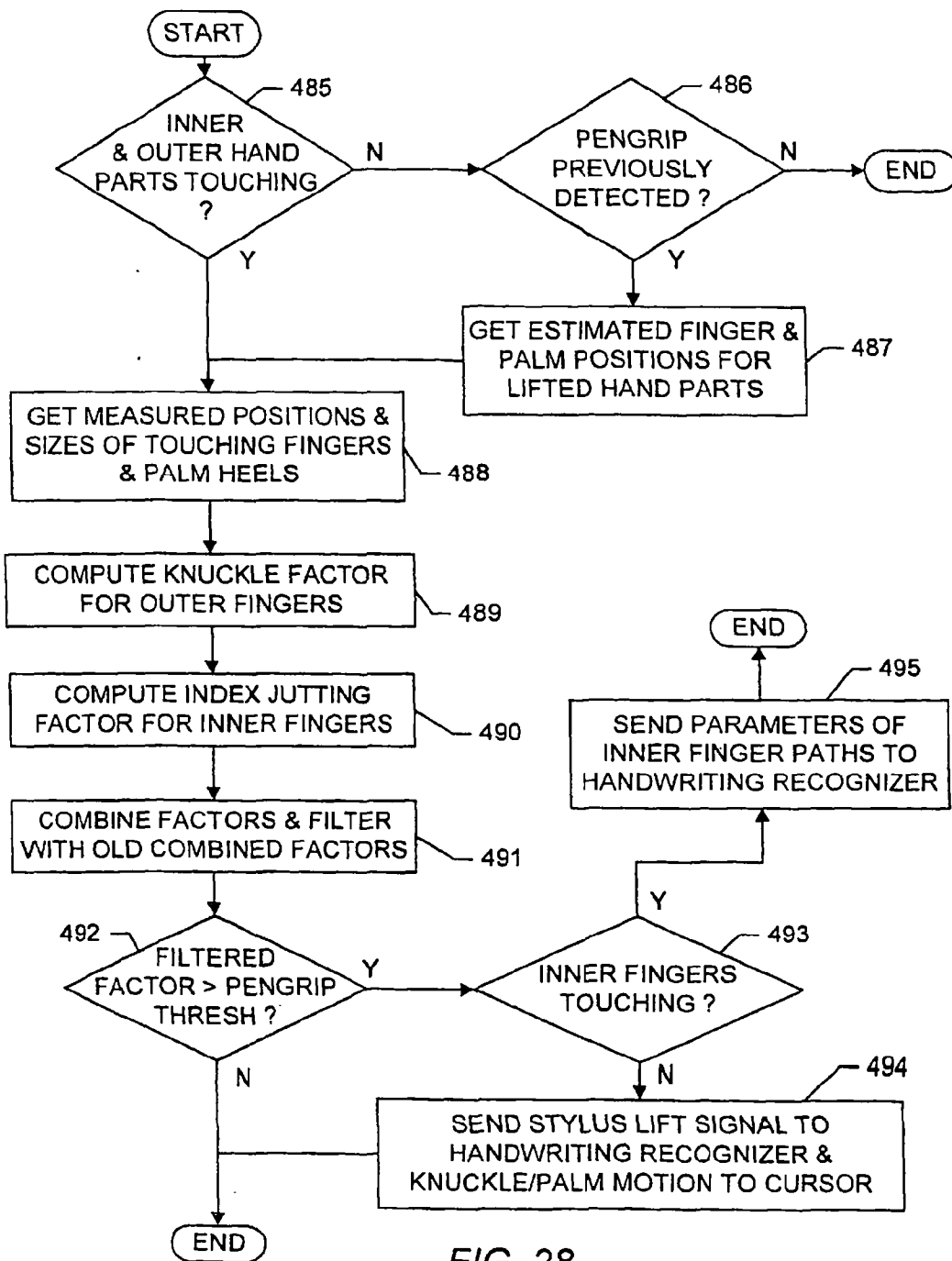

FIG. 28

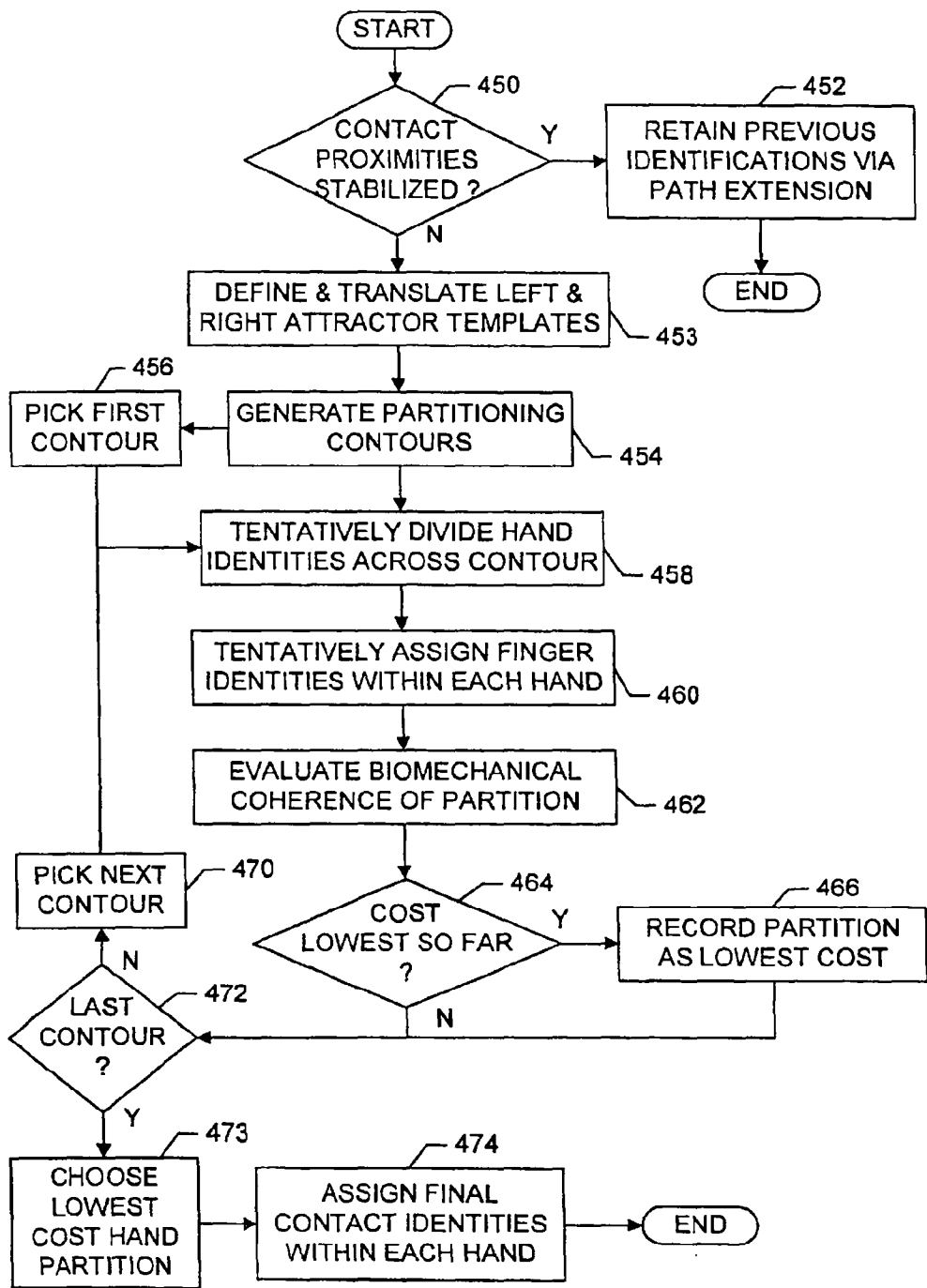

FIG. 29

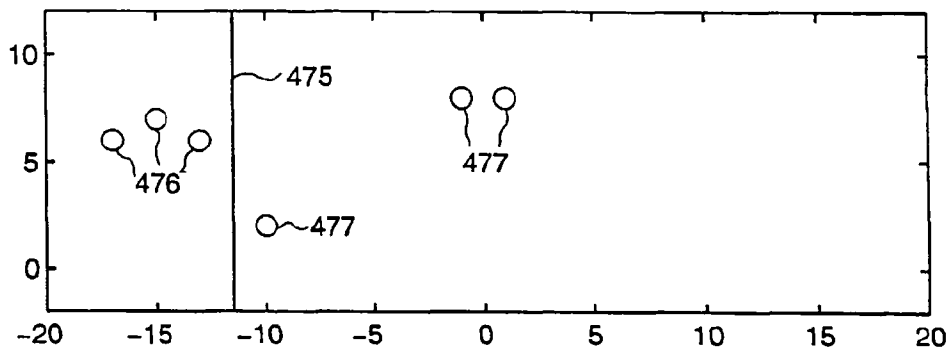

FIG. 30A

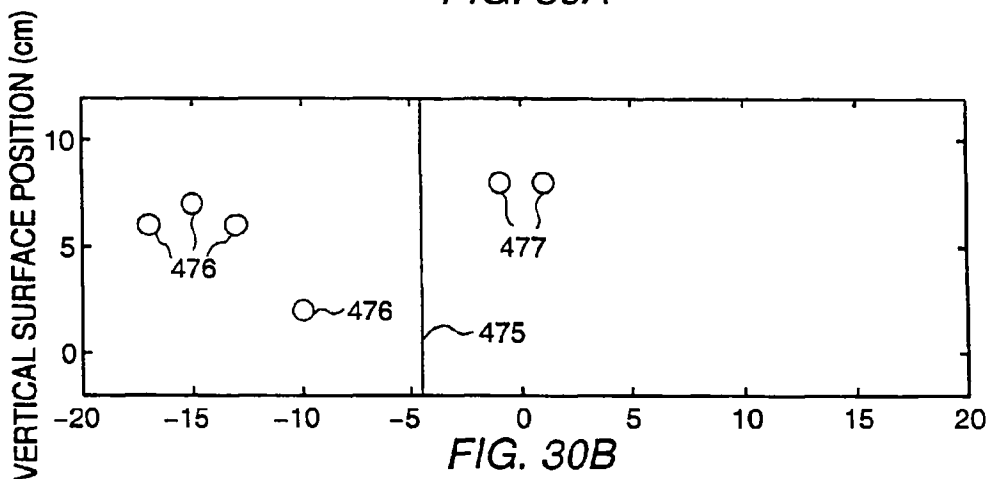

FIG. 30B

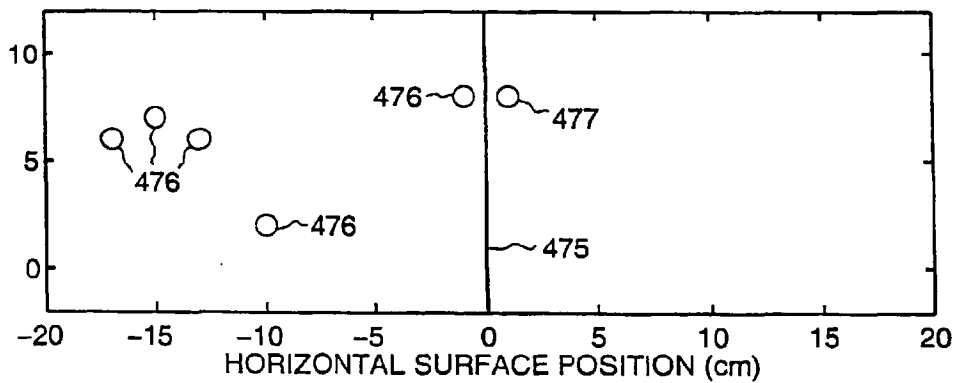

FIG. 30C

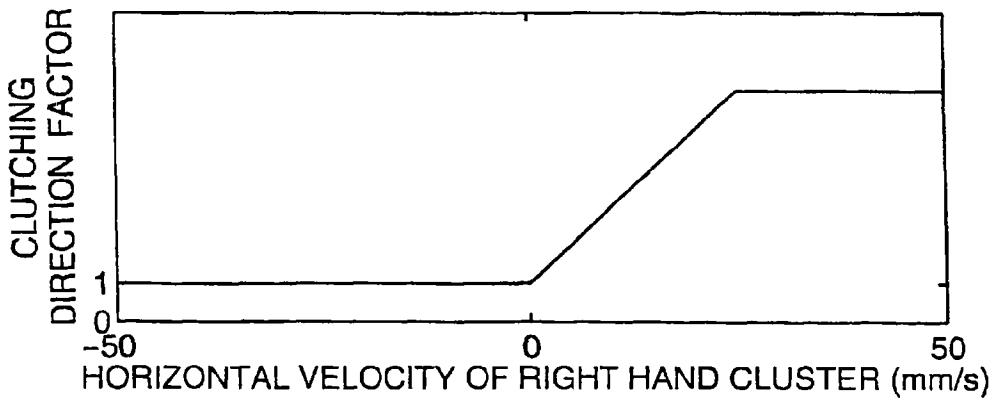

FIG. 31A

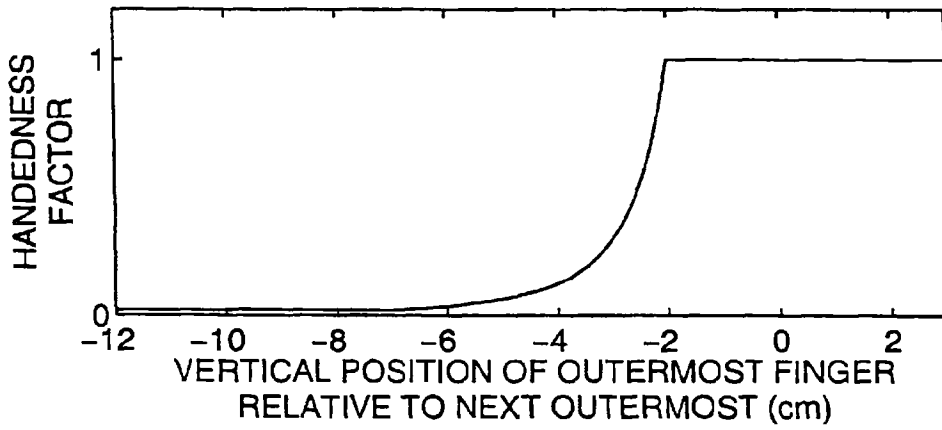

FIG. 31B

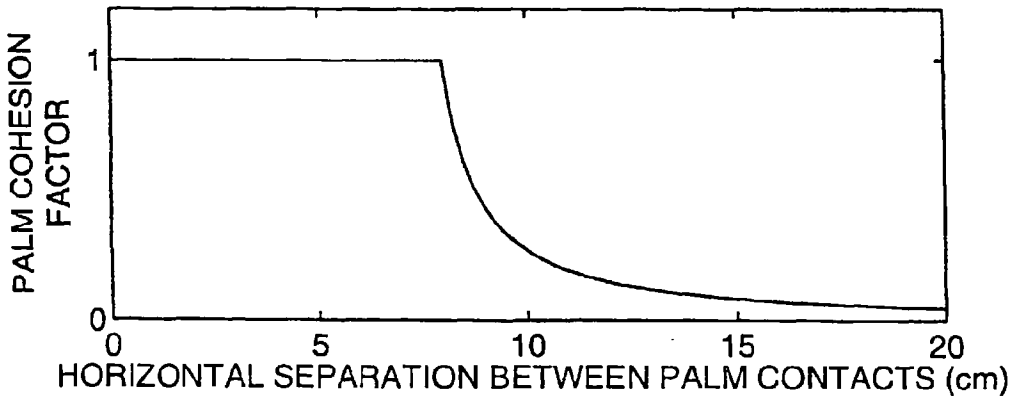

FIG. 31C

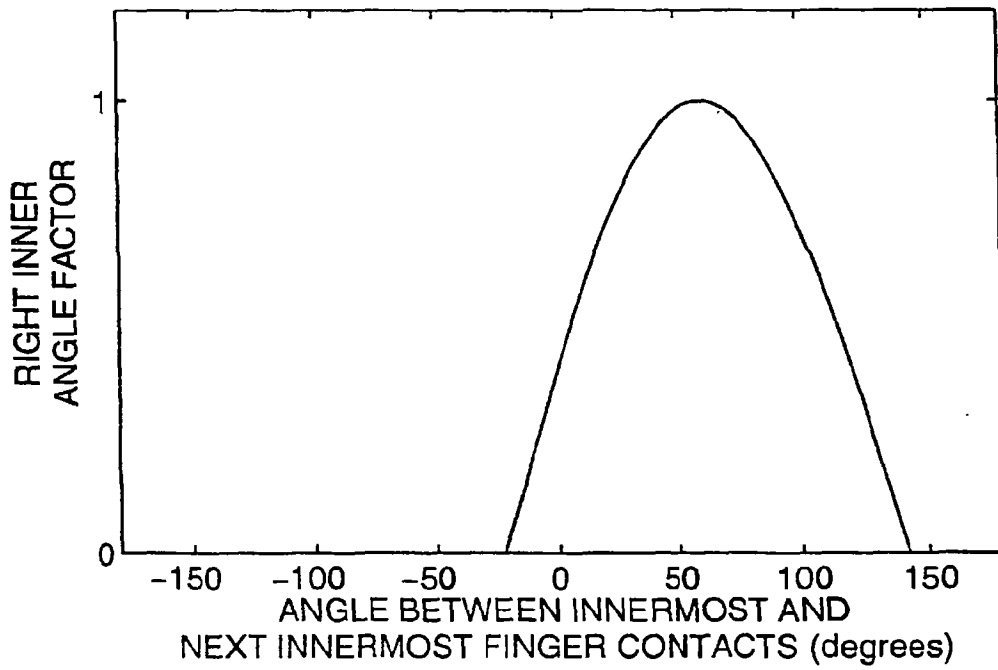

FIG. 32

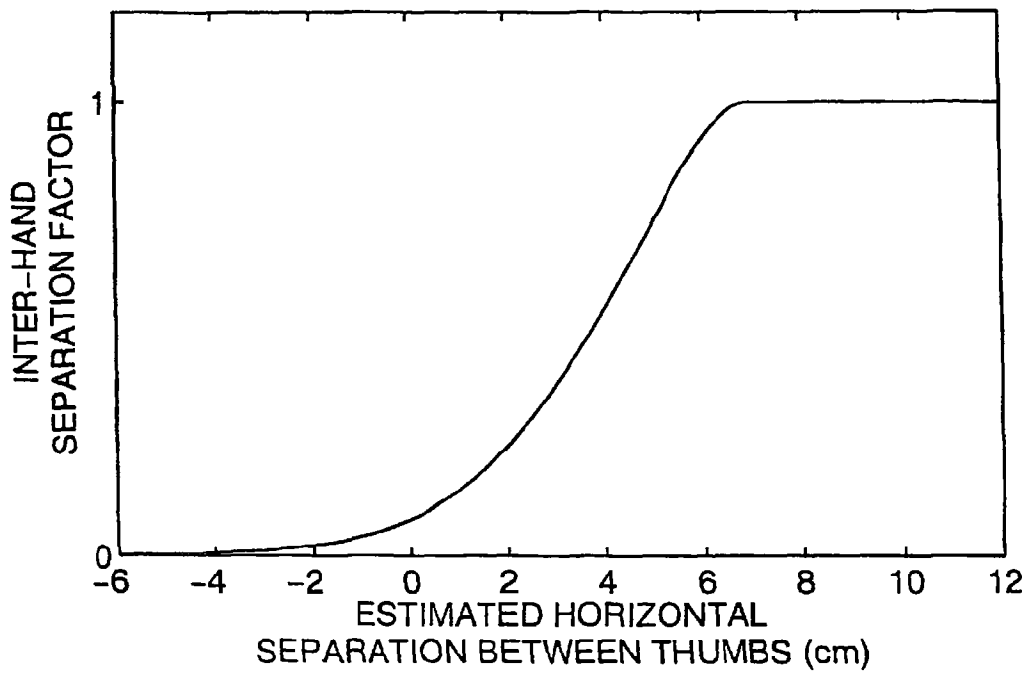

FIG. 33

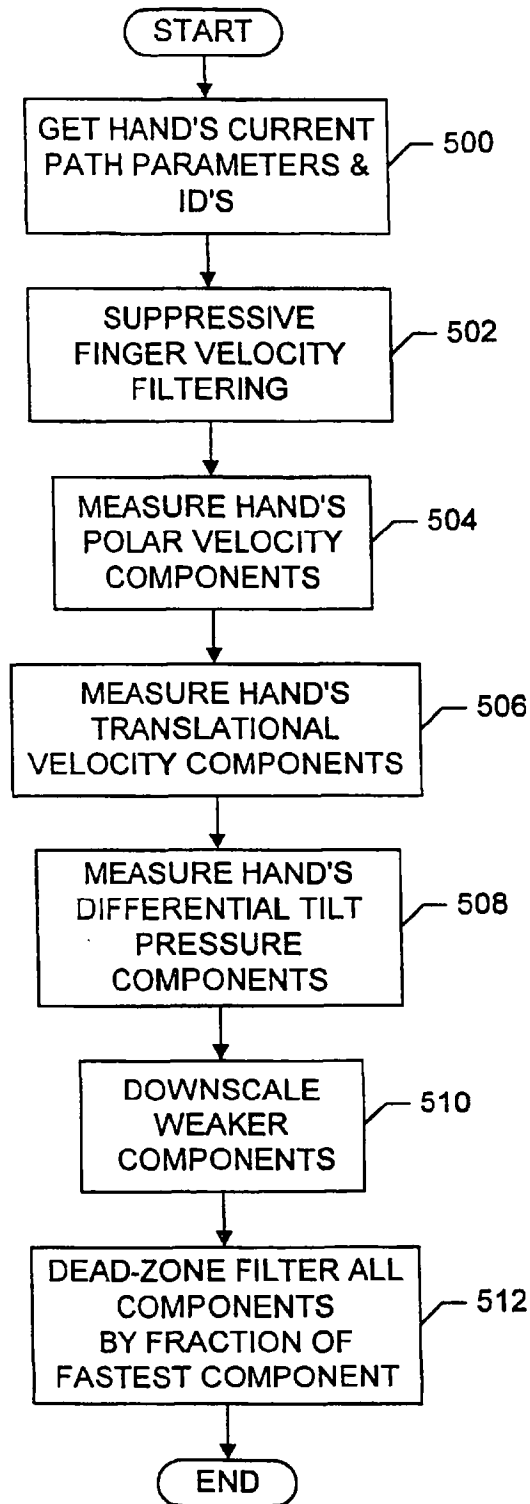

FIG. 34

U.S. Patent

Oct. 12, 2010

Sheet 34 of 45

US 7,812,828 B2

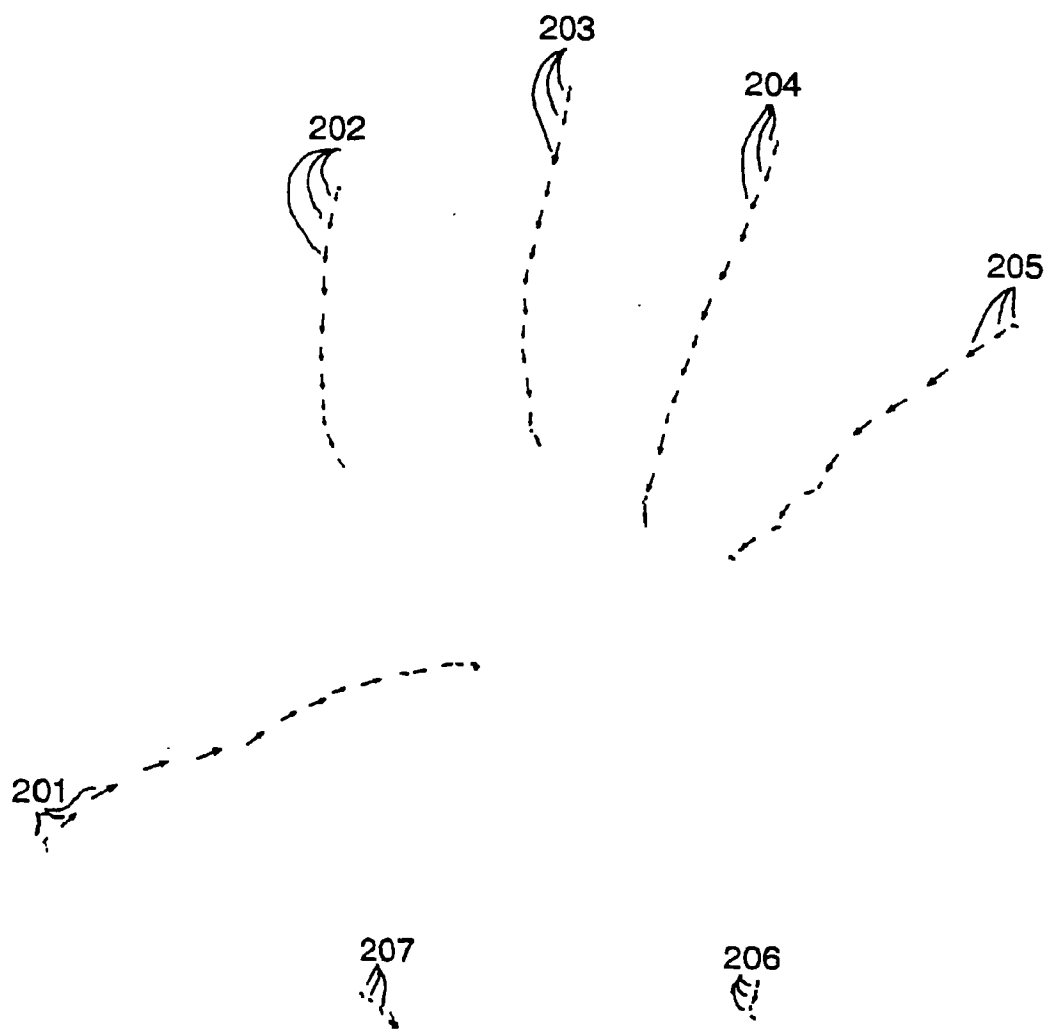

FIG. 35

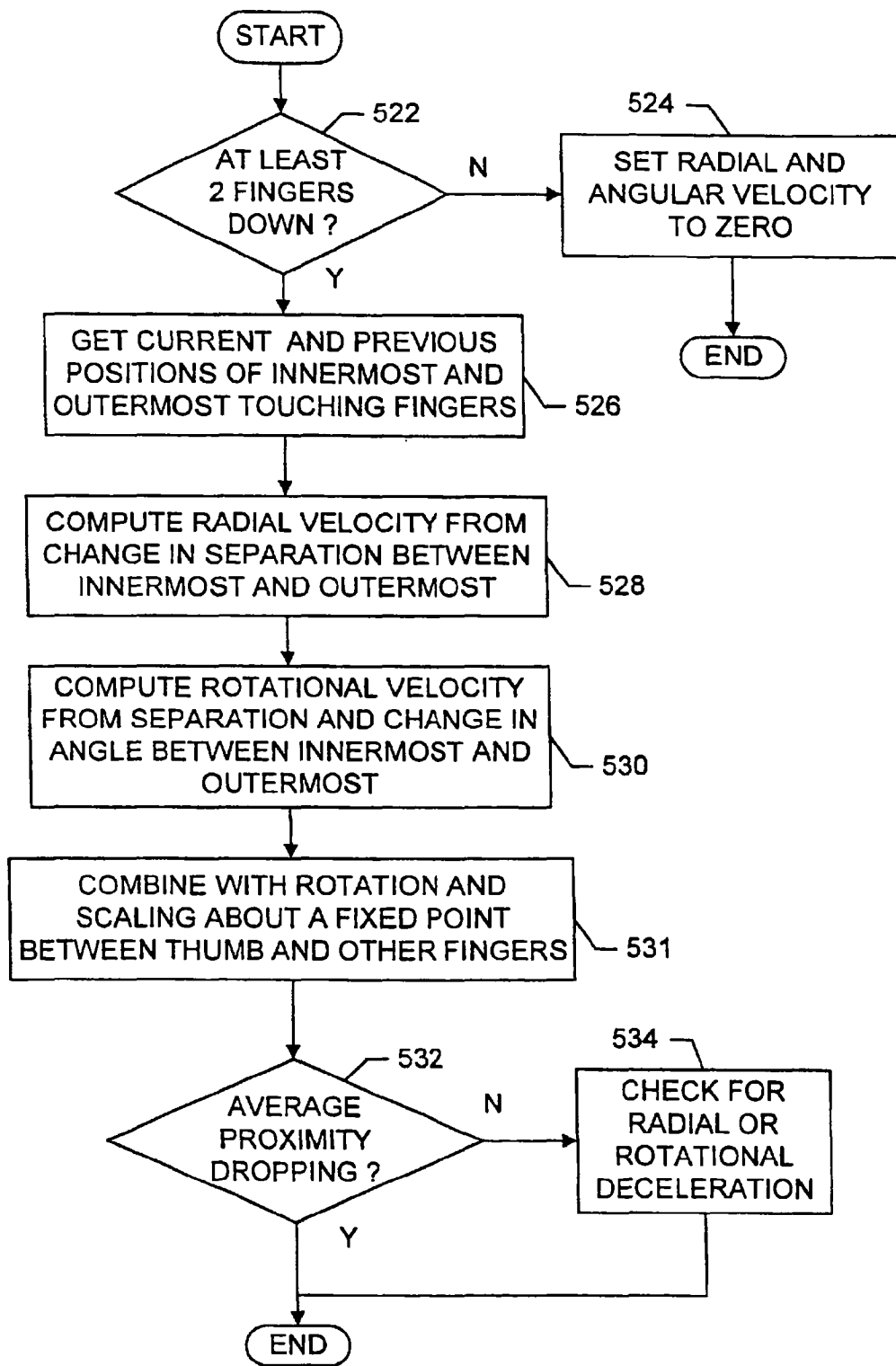

FIG. 36

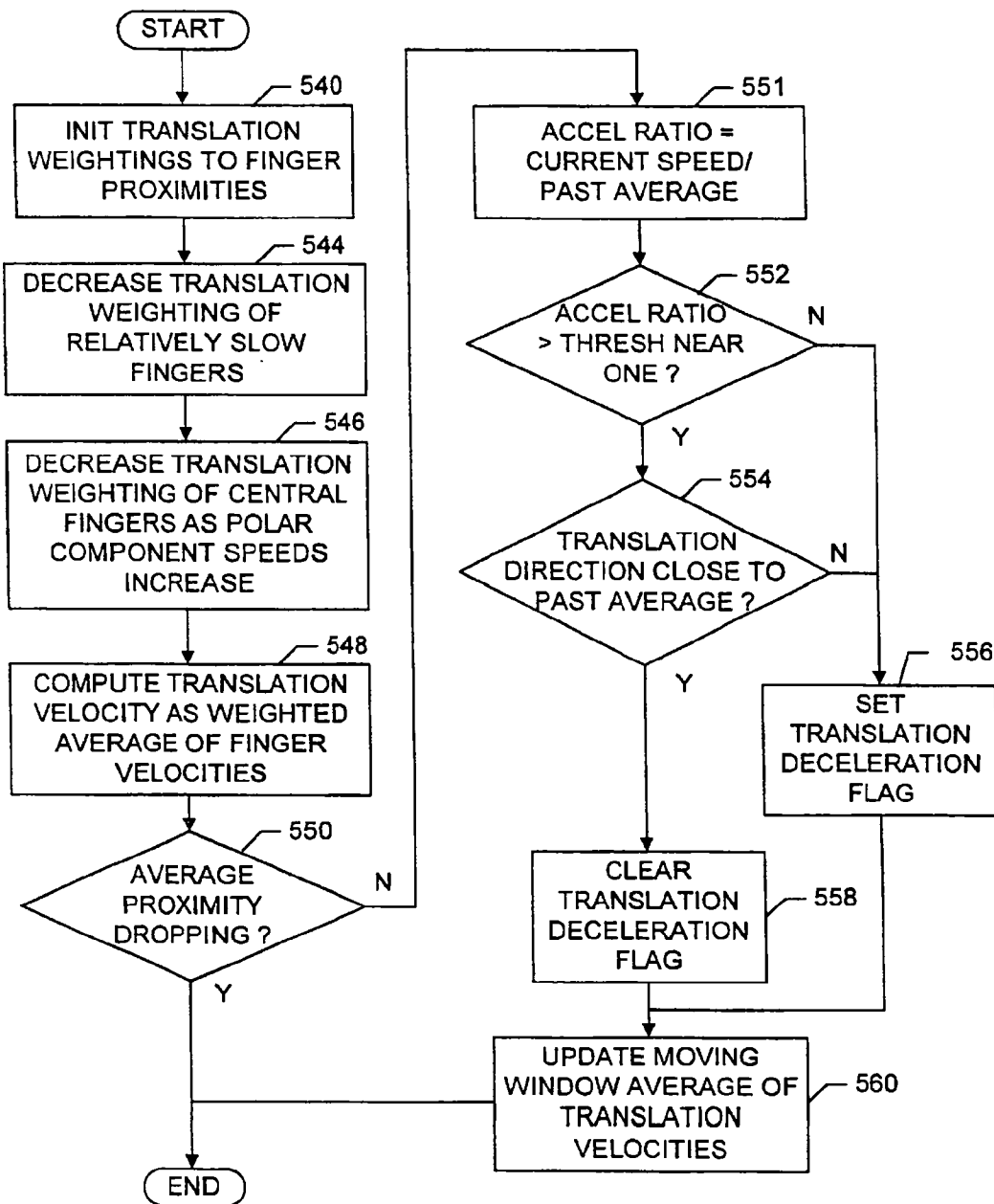

FIG. 37

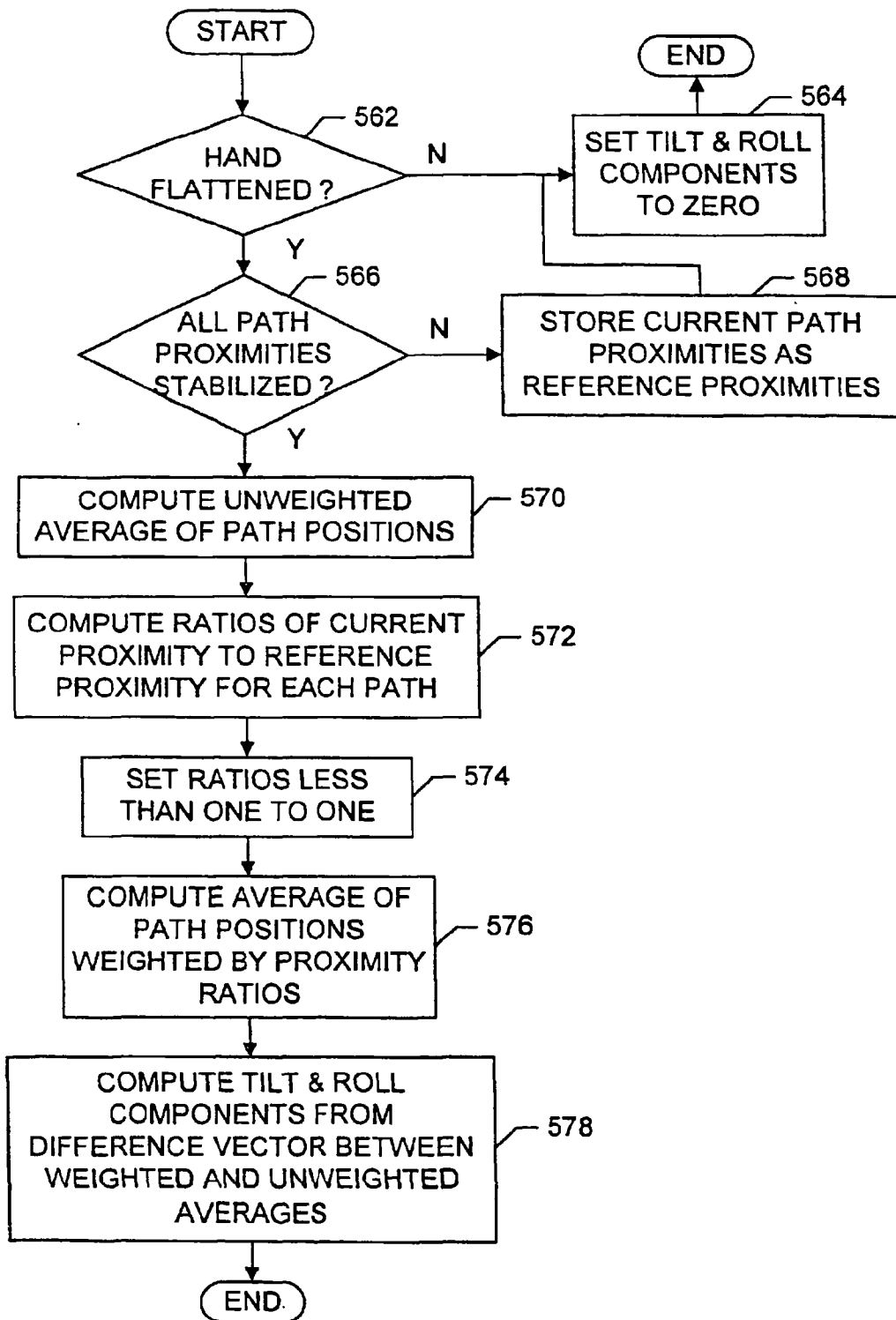

FIG. 38

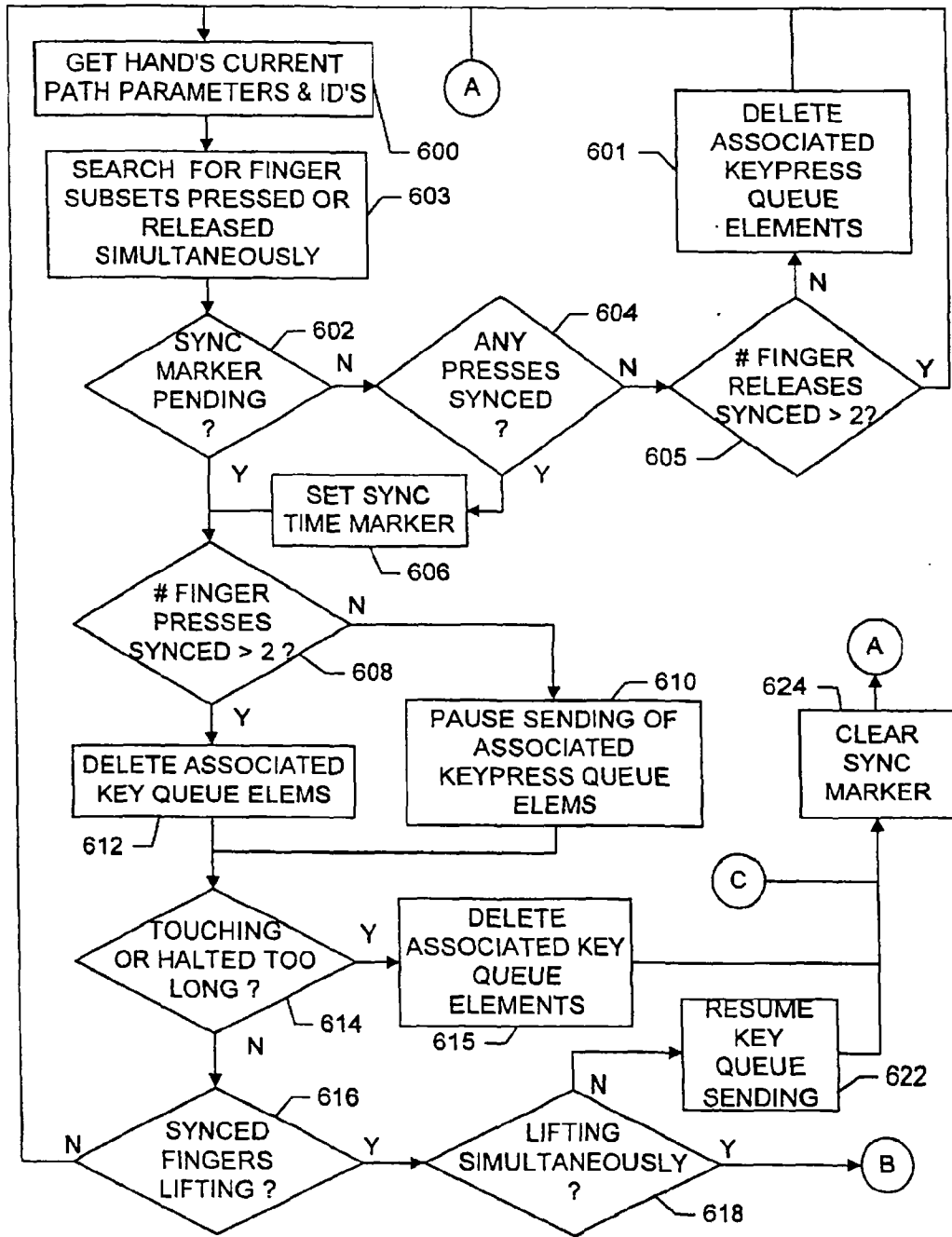

FIG. 39A

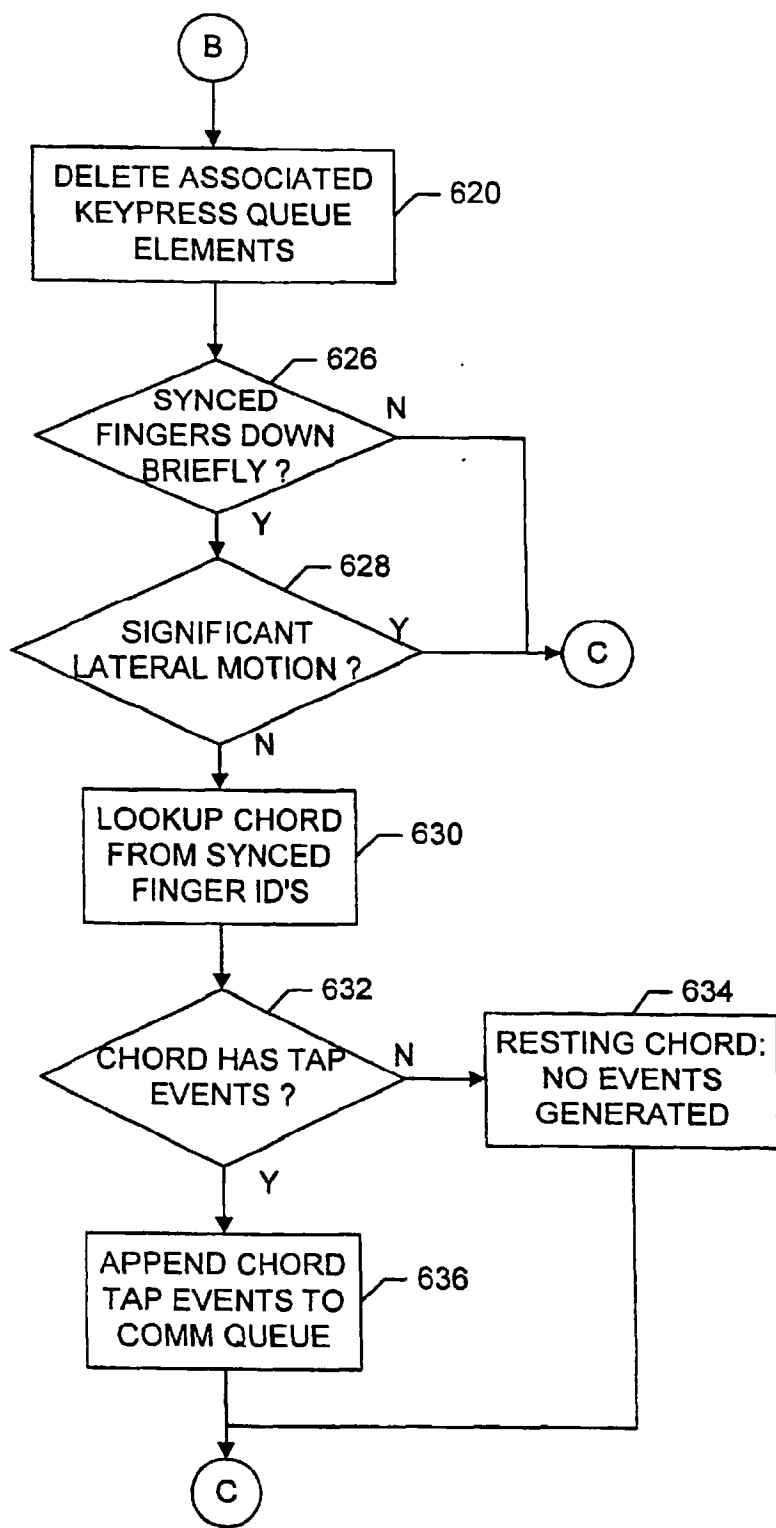

FIG. 39B

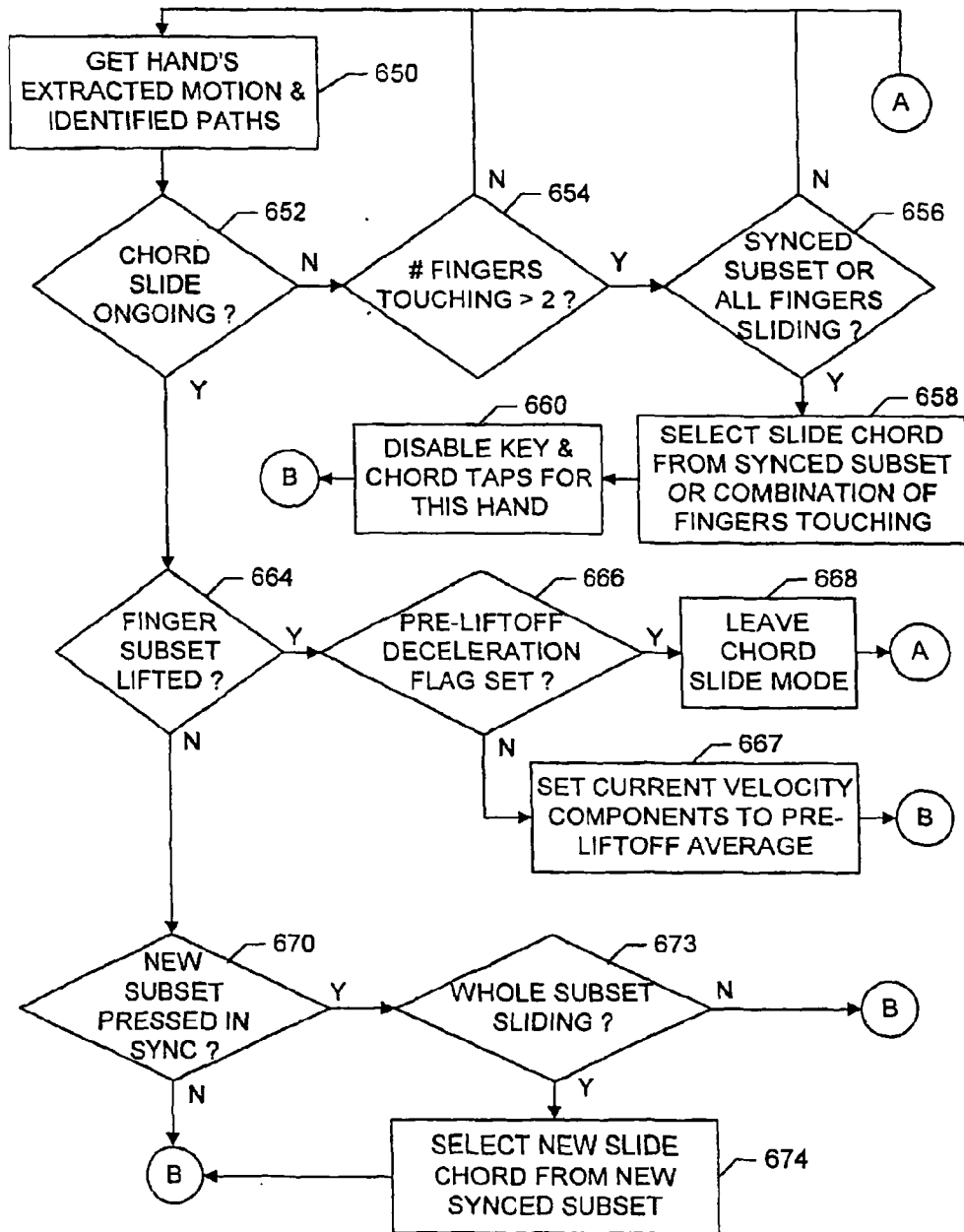

FIG. 40A

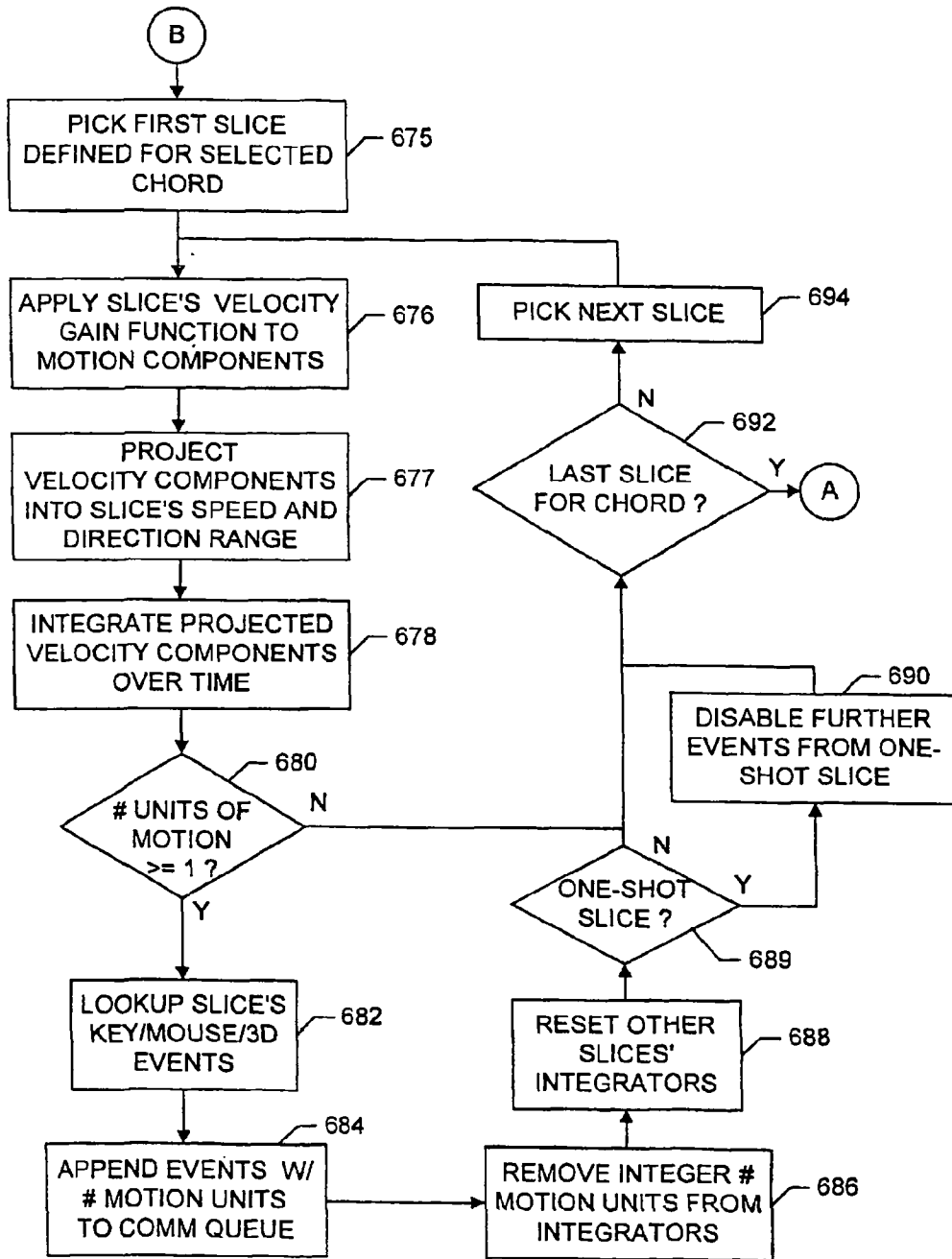

FIG. 40B

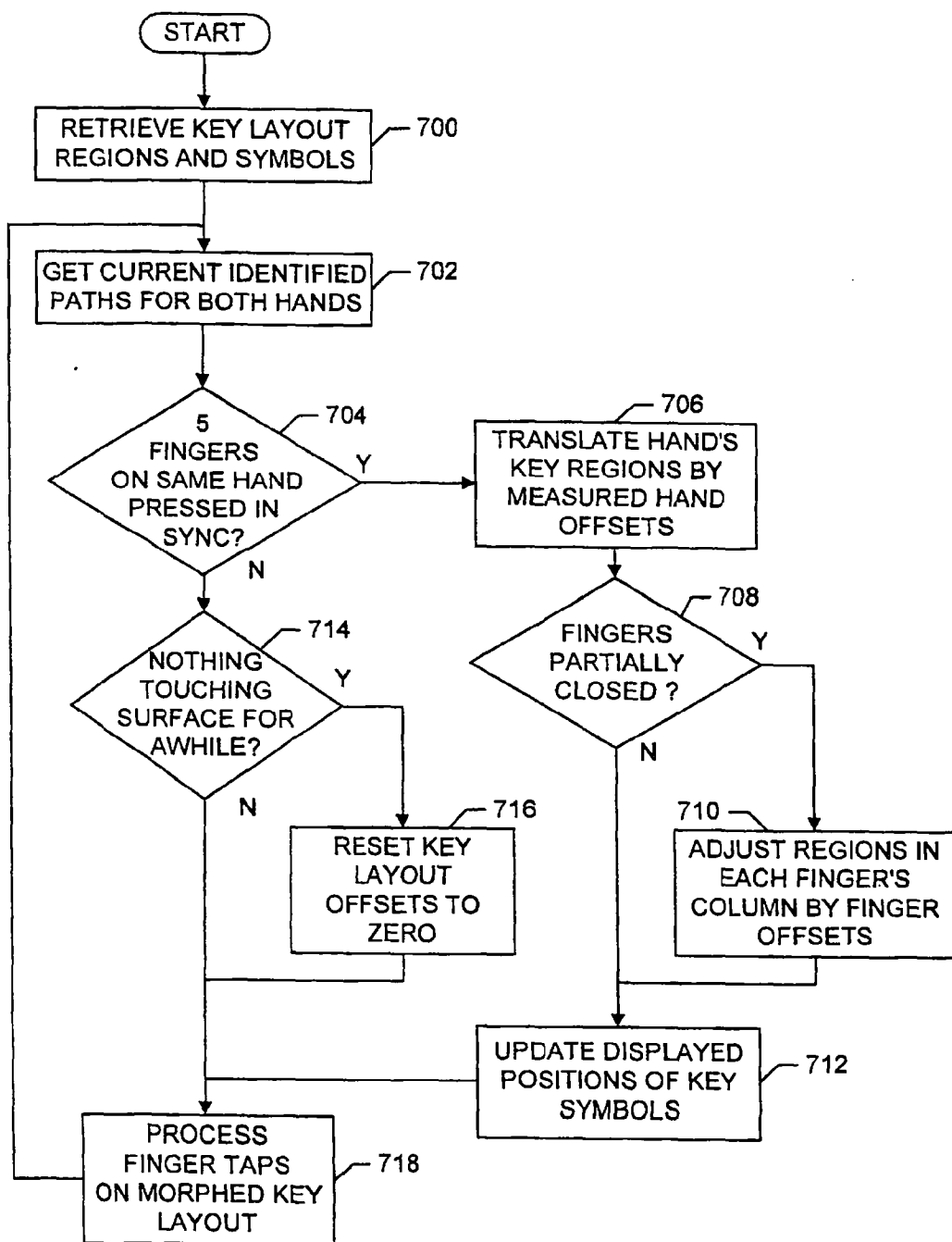

FIG. 41

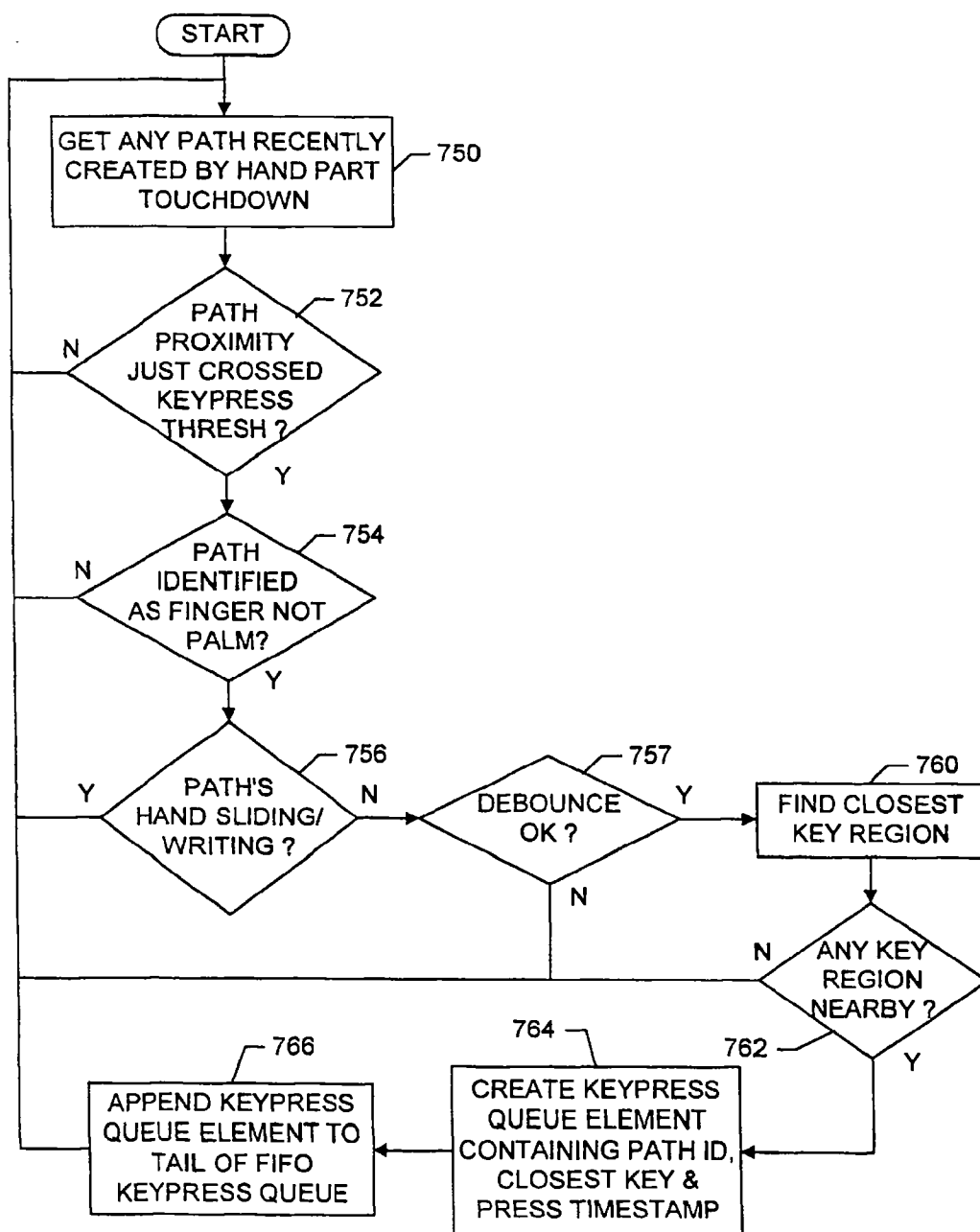

FIG. 42

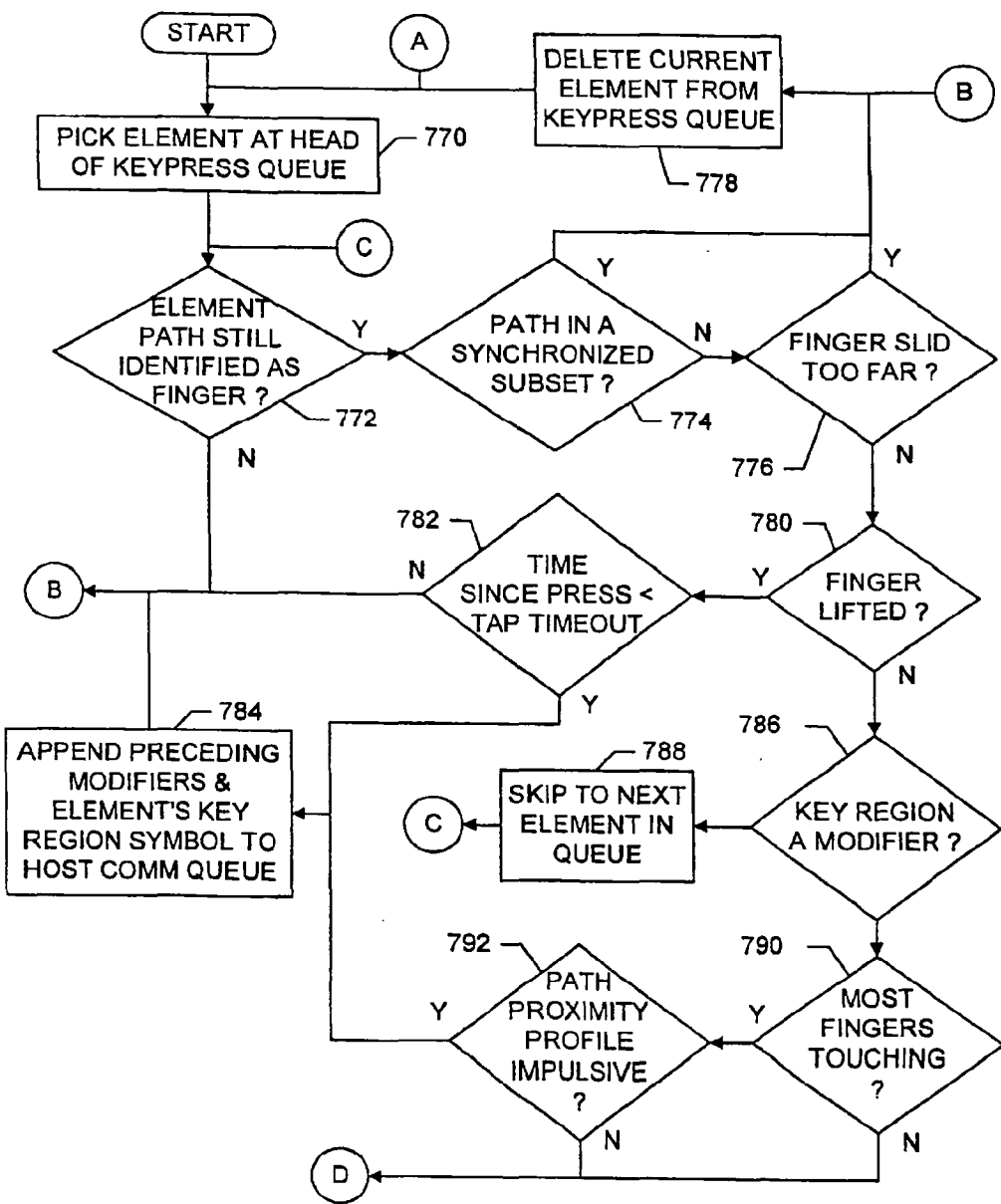

FIG. 43A

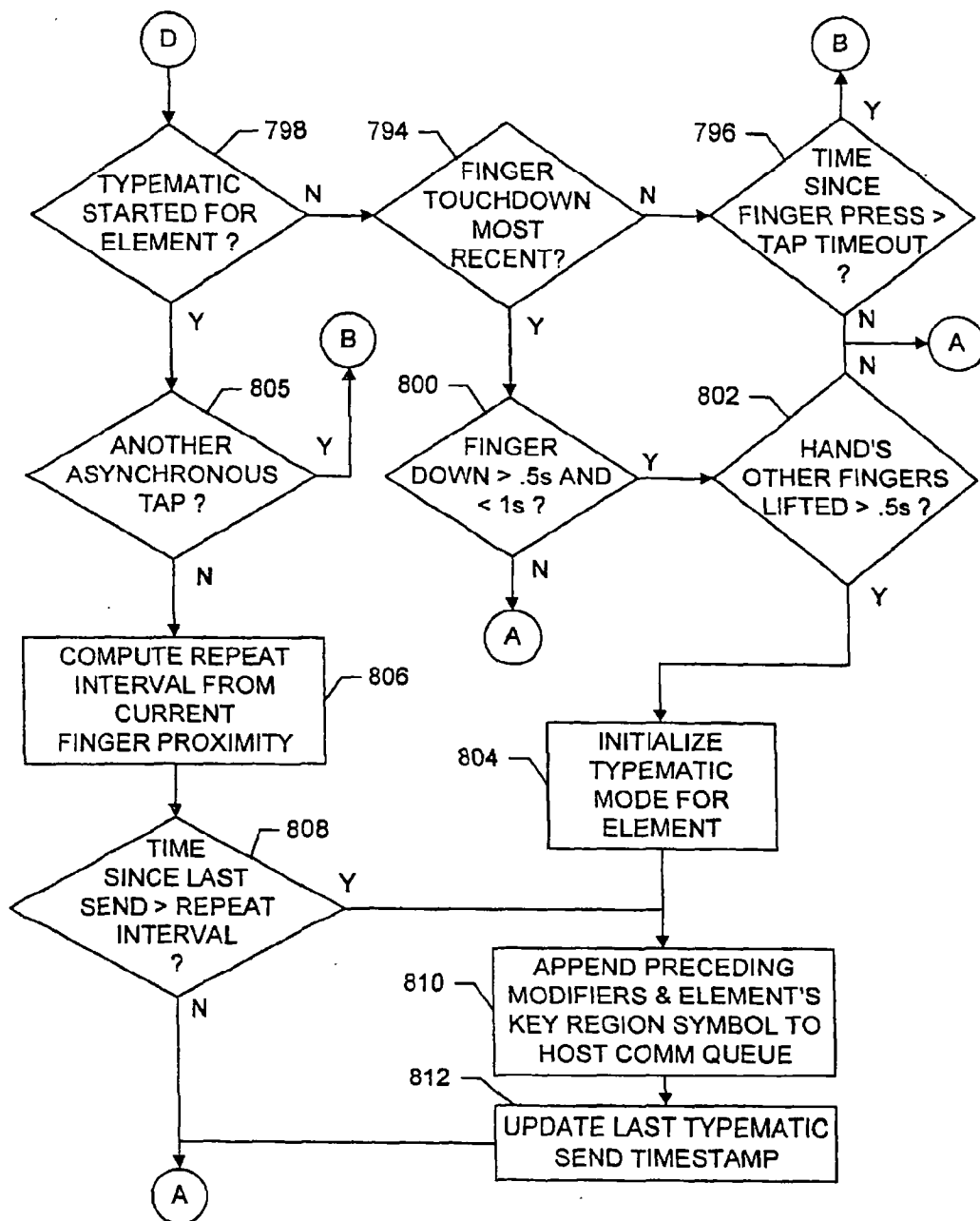

FIG. 43B

US 7,812,828 B2

1

ELLIPSE FITTING FOR MULTI-TOUCH SURFACES

CROSS-REFERENCE TO RELATED APPLICATIONS

This application is a continuation of 11/015,434, entitled "Method and Apparatus for Integrating Manual Input," filed Dec. 17, 2004 now U.S. Pat. No. 7,339,580, which is a continuation of 09/236,513 (now Pat. No. 6,323,846) filed Jan. 25, 1999 which claims the benefit of provisional application 60/072,509, filed Jan. 26, 1998, each of which is hereby incorporated by reference in its entirety. This application is also related to Application Ser. No. 11/428,501, entitled "Capacitive Sensing Arrangement," 11/428,503, entitled "Touch Surface," 11/428,506, entitled "User Interface Gestures," 11/428,515, entitled "User Interface Gestures," 11/428,522, entitled "Identifying Contacts on a Touch Surface," 11/428,521, entitled "Identifying Contacts on a Touch Surface," 11/559,736, entitled "Multi-Touch Contact Tracking Algorithm", 11/559,763, "Multi-Touch Contact Motion Extraction," 11/559,799, entitled "Multi-Touch Contact Motion Extraction," 11/559,822, entitled "Multi-Touch Contact Motion Extraction," 11/559,833, entitled Multi-Touch Hand Position Offset Computation, each of which is hereby incorporated by reference in its entirety.

BACKGROUND OF THE INVENTION

A. Field of the Invention

The present invention relates generally to methods and apparatus for data input, and, more particularly, to a method and apparatus for integrating manual input.

B. Description of the Related Art

Many methods for manual input of data and commands to computers are in use today, but each is most efficient and easy to use for particular types of data input. For example, drawing tablets with pens or pucks excel at drafting, sketching, and quick command gestures. Handwriting with a stylus is convenient for filling out forms which require signatures, special symbols, or small amounts of text, but handwriting is slow compared to typing and voice input for long documents. Mice, finger-sticks and touchpads excel at cursor pointing and graphical object manipulations such as drag and drop. Rollers, thumbwheels and trackballs excel at panning and scrolling. The diversity of tasks that many computer users encounter in a single day call for all of these techniques, but few users will pay for a multitude of input devices, and the separate devices are often incompatible in a usability and an ergonomic sense. For instance, drawing tablets are a must for graphics professionals, but switching between drawing and typing is inconvenient because the pen must be put down or held awkwardly between the fingers while typing. Thus, there is a long-felt need in the art for a manual input device which is cheap yet offers convenient integration of common manual input techniques.

Speech recognition is an exciting new technology which promises to relieve some of the input burden on user hands. However, voice is not appropriate for inputting all types of data either. Currently, voice input is best-suited for dictation of long text documents. Until natural language recognition matures sufficiently that very high level voice commands can be understood by the computer, voice will have little advantage over keyboard hot-keys and mouse menus for command and control. Furthermore, precise pointing, drawing, and manipulation of graphical objects is difficult with voice commands, no matter how well speech is understood. Thus, there

2

will always be a need in the art for multi-function manual input devices which supplement voice input.

A generic manual input device which combines the typing, pointing, scrolling, and handwriting capabilities of the standard input device collection must have ergonomic, economic, and productivity advantages which outweigh the unavoidable sacrifices of abandoning device specialization. The generic device must tightly integrate yet clearly distinguish the different types of input. It should therefore appear modeless to the user in the sense that the user should not need to provide explicit mode switch signals such as buttonpresses, arm relocations, or stylus pickups before switching from one input activity to another. Epidemiological studies suggest that repetition and force multiply in causing repetitive strain injuries. Awkward postures, device activation force, wasted motion, and repetition should be minimized to improve ergonomics. Furthermore, the workload should be spread evenly over all available muscle groups to avoid repetitive strain.

Repetition can be minimized by allocating to several graphical manipulation channels those tasks which require complex mouse pointer motion sequences. Common graphical user interface operations such as finding and manipulating a scroll bar or slider control are much less efficient than specialized finger motions which cause scrolling directly, without the step of repositioning the cursor over an on-screen control. Preferably the graphical manipulation channels should be distributed amongst many finger and hand motion combinations to spread the workload. Touchpads and mice with auxilliary scrolling controls such as the Cirque[®] Smartcat touchpad with edge scrolling, the IBM[®] Scroll-Point[™] mouse with embedded pointing stick, and the Roller Mouse described in U.S. Pat. No. 5,530,455 to Gillick et al. represent small improvements in this area, but still do not provide enough direct manipulation channels to eliminate many often-used cursor motion sequences. Furthermore, as S. Zhai et al. found in "Dual Stream Input for Pointing and Scrolling," Proceedings of CHI '97 Extended Abstracts (1997), manipulation of more than two degrees of freedom at a time is very difficult with these devices, preventing simultaneous panning, zooming and rotating.

Another common method for reducing excess motion and repetition is to automatically continue pointing or scrolling movement signals once the user has stopped moving or lifts the finger. Related art methods can be distinguished by the conditions under which such motion continuation is enabled. In U.S. Pat. No. 4,734,685, Watanabe continues image panning when the distance and velocity of pointing device movement exceed thresholds. Automatic panning is, stopped by moving the pointing device back in the opposite direction, so stopping requires additional precise movements. In U.S. Pat. No. 5,543,591 to Gillespie et al., motion continuation occurs when the finger enters an edge border region around a small touchpad. Continued motion speed is fixed and the direction corresponds to the direction from the center of the touchpad to the finger at the edge. Continuation mode ends when the finger leaves the border region or lifts off the pad. Disadvantageously, users sometimes pause at the edge of the pad without intending for cursor motion to continue, and the unexpected motion continuation becomes annoying. U.S. Pat. No. 5,327,161 to Logan et al. describes motion continuation when the finger enters a border area as well, but in an alternative trackball emulation mode, motion continuation can be a function solely of lateral finger velocity and direction at liftoff. Motion continuation decays due to a friction factor or can be stopped by a subsequent touchdown on the surface. Disadvantageously, touch velocity at liftoff is not a reliable indicator of the user's desire for motion continuation since

US 7,812,828 B2

3

when approaching a large target on a display at high speeds the user may not stop the pointer completely before liftoff. Thus it would be an advance in the art to provide a motion continuation method which does not become activated unexpectedly when the user really intended to stop pointer movement at a target but happens to be on a border or happens to be moving at significant speed during liftoff.

Many attempts have been made to embed pointing devices in a keyboard so the hands do not have to leave typing position to access the pointing device. These include the integrated pointing key described in U.S. Pat. No. 5,189,403 to Franz et al., the integrated pointing stick disclosed by J. Rutledge and T. Selker in "Force-to-Motion Functions for Pointing," Human-Computer Interaction—INTERACT '90, pp. 701-06 (1990), and the position sensing keys described in U.S. Pat. No. 5,675,361 to Santilli. Nevertheless, the limited movement range and resolution of these devices, leads to poorer pointing speed and accuracy than a mouse, and they add mechanical complexity to keyboard construction. Thus there exists a need in the art for pointing methods with higher resolution, larger movement range, and more degrees of freedom yet which are easily accessible from typing hand positions.

Touch screens and touchpads often distinguish pointing motions from emulated button clicks or keypresses by assuming very little lateral fingertip motion will occur during taps on the touch surface which are intended as clicks. Inherent in these methods is the assumption that tapping will usually be straight down from the suspended finger position, minimizing those components of finger motion tangential to the surface. This is a valid assumption if the surface is not finely divided into distinct key areas or if the user does a slow, "hunt and peck" visual search for each key before striking. For example, in U.S. Pat. No. 5,543,591 to Gillespie et al., a touchpad sends all lateral motions to the host computer as cursor movements. However, if the finger is lifted soon enough after touchdown to count as a tap and if the accumulated lateral motions are not excessive, any sent motions are undone and a mouse button click is sent instead. This method only works for mouse commands such as pointing which can safely be undone, not for dragging or other manipulations. In U.S. Pat. No. 5,666,113 to Logan, taps with less than about $\frac{1}{16}$ " lateral motion activate keys on a small keypad while lateral motion in excess of $\frac{1}{16}$ " activates cursor control mode. In both patents cursor mode is invoked by default when a finger stays on the surface a long time.

However, fast touch typing on a surface divided into a large array of key regions tends to produce more tangential motions along the surface than related art filtering techniques can tolerate. Such an array contains keys in multiple rows and columns which may not be directly under the fingers, so the user must reach with the hand or flex or extend fingers to touch many of the key regions. Quick reaching and extending imparts significant lateral finger motion while the finger is in the air which may still be present when the finger contacts the surface. Glancing taps with as much as $\frac{1}{4}$ " lateral motion measured at the surface can easily result. Attempting to filter or suppress this much motion would make the cursor seem sluggish and unresponsive. Furthermore, it may be desirable to enter a typematic or automatic key repeat mode instead of pointing mode when the finger is held in one place on the surface. Any lateral shifting by the fingertip during a prolonged finger press would also be picked up as cursor jitter without heavy filtering. Thus, there is a need in the art for a method to distinguish keying from pointing on the same surface via more robust hand configuration cues than lateral motion of a single finger.

4

An ergonomic typing system should require minimal key tapping force, easily distinguish finger taps from resting hands, and cushion the fingers from the jarring force of surface impact. Mechanical and membrane keyboards rely on the spring force in the keyswitches to prevent activation when the hands are resting on the keys. This causes an irreconcilable tradeoff between the ergonomic desires to reduce the fatigue from key activating force and to relax the full weight of the hands onto the keys during rest periods. Force minimization on touch surfaces is possible with capacitive or active optical sensing, which do not rely on finger pressure, rather than resistive-membrane or surface-acoustic-wave sensing techniques. The related art touch devices discussed below will become confused if a whole hand including its four fingertips a thumb and possibly palm heels, rests on the surface. Thus, there exists a long felt need in the art for a multi-touch surface typing system based on zero-force capacitive sensing which can tolerate resting hands and a surface cushion.

An ergonomic typing system should also adapt to individual hand sizes tolerate variations in typing style, and support a range of healthy hand postures. Though many ergonomic keyboards have been proposed, mechanical keyswitches can only be repositioned at great cost. For example, the keyboard with concave keywells described by Hargreaves et al. in U.S. Pat. No. 5,689,253 fits most hands well but also tends to lock the arms in a single position. A touch surface key layout could easily be morphed, translated, or arbitrarily reconfigured as long as the changes did not confuse the user. However, touch surfaces may not provide as much laterally orienting tactile feedback as the edges of mechanical keyswitches. Thus, there exists a need in the art for a surface typing recognizer which can adapt a key layout to fit individual hand postures and which can sustain typing accuracy if the hands drift due to limited tactile feedback.

Handwriting on smooth touch surfaces using a stylus is well-known in the art, but it typically does not integrate well with typing and pointing because the stylus must be put down somewhere or held awkwardly during other input activities. Also, it may be difficult to distinguish the handwriting activity of the stylus from pointing motions of a fingertip. Thus there exists a need in the art for a method to capture coarse handwriting gestures without a stylus and without confusing them with pointing motions.

Many of the input differentiation needs cited above could be met with a touch sensing technology which distinguishes a variety of hand configurations and motions such as sliding finger chords and grips. Many mechanical chord keyboards have been designed to detect simultaneous downward activity from multiple fingers, but they do not detect lateral finger motion over a large range. Related art shows several examples of capacitive touchpads which emulate a mouse or keyboard by tracking a single finger. These typically measure the capacitance of or between elongated wires which are laid out in rows and columns. A thin dielectric is interposed between the row and column layers. Presence of a finger perturbs the self or mutual capacitance for nearby electrodes. Since most of these technologies use projective row and column sensors which integrate on one electrode the proximity of all objects in a particular row or column, they cannot uniquely determine the positions of two or more objects as discussed in S. Lee, "A Fast Multiple-Touch-Sensitive Input Device," University of Toronto Masters Thesis (1984). The best they can do is count fingertips which happen to lie in a straight row, and even that will fail if a thumb or palm is introduced in the same column as a fingertip.

US 7,812,828 B2

5

In U.S. Pat. Nos. 5,565,658 and 5,305,017, Gerpheide et al. measure the mutual capacitance between row and column electrodes by driving one set of electrodes at some clock frequency and sensing how much of that frequency is coupled onto a second electrode set. Such synchronous measurements are very prone to noise at the driving frequency, so to increase signal-to-noise ratio they form virtual electrodes comprised of multiple rows or multiple columns, instead of a single row and column, and scan through electrode combinations until the various mutual capacitances are nulled or balanced. The coupled signal increases with the product of the rows and columns in each virtual electrodes, but the noise only increases with the sum, giving a net gain in signal-to-noise ratio for virtual electrodes consisting of more than two rows and two columns. However, to uniquely distinguish multiple objects, virtual electrode sizes would have to be reduced so the intersection of the row and column virtual electrodes would be no larger than a finger tip, i.e., about two rows and two columns, which will degrade the signal-to-noise ratio. Also, the signal-to-noise ratio drops as row and column lengths increase to cover a large area.

In U.S. Pat. Nos. 5,543,591, 5,543,590, and 5,495,077, Gillespie et al measure the electrode-finger self-capacitance for row and column electrodes independently. Total electrode capacitance is estimated by measuring the electrode voltage change caused by injecting or removing a known amount of charge in a known time. All electrodes can be measured simultaneously if each electrode has its own drive/sense circuit. The centroid calculated from all row and column electrode signals establishes an interpolated vertical and horizontal position for a single object. This method may in general have higher signal-to-noise ratio than synchronous methods, but the signal-to-noise ratio is still degraded as row and column lengths increase. Signal-to-noise ratio is especially important for accurately locating objects which are floating a few millimeters above the pad. Though this method can detect such objects, it tends to report their position as being near the middle of the pad, or simply does not detect floating objects near the edges.

Thus there exists a need in the art for a capacitance-sensing apparatus which does not suffer from poor signal-to-noise ratio and the multiple finger indistinguishability problems of touchpads with long row and column electrodes.

U.S. Pat. No. 5,463,388 to Boie et al. has a capacitive sensing system applicable to either keyboard or mouse input, but does not consider the problem of integrating both types of input simultaneously. Though they mention independent detection of arrayed unit-cell electrodes, their capacitance transduction circuitry appears too complex to be economically reproduced at each electrode. Thus the long lead wires connecting electrodes to remote signal conditioning circuitry can pickup noise and will have significant capacitance compared to the finger-electrode self-capacitance, again limiting signal-to-noise ratio. Also, they do not recognize the importance of independent electrodes for multiple finger tracking, or mention how to track multiple fingers on an independent electrode array.

Lee built an early multi-touch electrode array, with 7 mm by 4 mm metal electrodes arranged in 32 rows and 64 columns. The "Fast Multiple-Touch-Sensitive Input Device (FMTSID)" total active area measured 12" by 16", with a 0.075 mm Mylar dielectric to insulate fingers from electrodes. Each electrode had one diode connected to a row charging line and a second diode connected to a column discharging line. Electrode capacitance changes were measured singly or in rectangular groups by raising the voltage on one or more row lines, selectively charging the electrodes in

6

those rows, and then timing the discharge of selected columns to ground through a discharge resistor. Lee's design required only two diodes per electrode, but the principal disadvantage of Lee's design is that the column diode reverse bias capacitances allowed interference between electrodes in the same column.

All of the related capacitance sensing art cited above utilize interpolation between electrodes to achieve high pointing resolution with economical electrode density. Both Boie et al. and Gillespie et al. discuss computation of a centroid from all row and column electrode readings. However, for multiple finger detection, centroid calculation must be carefully limited around local maxima to include only one finger at a time. Lee utilizes a bisective search technique to find local maxima and then interpolates only on the eight nearest neighbor electrodes of each local maximum electrode. This may work fine for small fingertips, but thumb and palm contacts may cover more than nine electrodes. Thus there exists a need in the art for improved means to group exactly those electrodes which are covered by each distinguishable hand contact and to compute a centroid from such potentially irregular groups.

To take maximum advantage of multi-touch surface sensing, complex proximity image processing is necessary to track and identify the parts of the hand contacting the surface at any one time. Compared to passive optical, images, proximity images provide clear indications of where the body contacts the surface, uncluttered by luminosity variation and extraneous objects in the background. Thus proximity image filtering and segmentation stages can be simpler and more reliable than in computer vision approaches to free-space hand tracking such as S. Alimad, "A Usable Real-Time 3D Hand Tracker," Proceedings of the 28th Asilomar Conference on Signals, Systems, and Computers—Part 2, vol. 2, IEEE (1994) or Y. Cui and J. Wang, "Hand Segmentation Using Learning-Based Prediction and Verification for Hand Sign Recognition," Proceedings of the 1996 IEEE Computer Society Conference on Computer Vision and Pattern Recognition, pp. 88-93 (1996). However, parts of the hand such as intermediate finger joints and the center of the palms do not show up in capacitive proximity images at all if the hand is not flattened on the surface. Without these intermediate linkages between fingertips and palms the overall hand structure can only be guessed at, making hand contact identification very difficult. Hence the optical flow and contour tracking techniques which have been applied to free-space hand sign language recognition as in F. Quek, "Unencumbered Gestural Interaction," IEEE Multimedia, vol. 3, pp. 36-47 (1996), do not address the special challenges of proximity image tracking.

Synaptics Corp. has successfully fabricated their electrode array on flexible mylar film rather than stiff circuit board. This is suitable for conforming to the contours of special products, but does not provide significant finger cushioning for large surfaces. Even if a cushion was placed under the film, the lack of stretchability in the film, leads, and electrodes would limit the compliance afforded by the compressible material. Boie et al suggests that placing compressible insulators on top of the electrode array cushions finger impact. However, an insulator more than about one millimeter thick would seriously attenuate the measured finger-electrode capacitances. Thus there exists a need in the art for a method to transfer finger capacitance influences through an arbitrarily thick cushion.

SUMMARY OF THE INVENTION

It is a primary object of the present invention to provide a system and method for integrating different types of manual

US 7,812,828 B2

7

input such as typing, multiple degree-of-freedom manipulation, and handwriting on a multi-touch surface.

It is also an object of the present invention to provide a system and method for distinguishing different types of manual input such as typing, multiple degree-of-freedom manipulation, and handwriting on a multi-touch surface, via different hand configurations which are easy for the user to learn and easy for the system to recognize.

It is a further object of the present invention to provide an improved capacitance-transducing apparatus that is cheaply implemented near each electrode so that two-dimensional sensor arrays of arbitrary size and resolution can be built without degradation in signal to noise.

It is a further object of the present invention to provide an electronic system which minimizes the number of sensing electrodes necessary to obtain proximity images with such resolution that a variety of hand configurations can be distinguished.

Yet another object of the present invention is to provide a multi-touch surface apparatus which is compliant and contoured to be comfortable and ergonomic under extended use.

Yet another object of the present invention is to provide tactile key or hand position feedback without impeding hand resting on the surface or smooth, accurate sliding across the surface.

It is a further object of the present invention to provide an electronic system which can provide images of flesh proximity to an array of sensors with such resolution that a variety of hand configurations can be distinguished.

It is another object of the present invention to provide an improved method for invoking cursor motion continuation only when the user wants it by not invoking it when significant deceleration is detected.

Another object of the present invention is to identify different hand parts as they contact the surface so that a variety of hand configurations can be recognized and used to distinguish different kinds of input activity.

Yet another object of the present invention is to reliably extract rotation and scaling as well as translation degrees of freedom from the motion of two or more hand contacts to aid in navigation and manipulation of two-dimensional electronic documents.

It is a further object of the present invention to reliably extract tilt and roll degrees of freedom from hand pressure differences to aid in navigation and manipulation of three-dimensional environments.

Additional objects and advantages of the invention will be set forth in part in the description which follows, and in part will be obvious from the description, or may be learned by practice of the invention. The objects and advantages of the invention will be realized and attained by means of the elements and combinations particularly pointed out in the appended claims.

To achieve the objects and in accordance with the purpose of the invention, as embodied and broadly described herein, the invention comprises a sensing device that is sensitive to changes in self-capacitance brought about by changes in proximity of a touch device to the sensing device, the sensing device comprising: two electrical switching means connected together in series having a common node, an input node, and an output node; a dielectric-covered sensing electrode connected to the common node between the two switching means; a power supply providing an approximately constant voltage connected to the input node of the series-connected switching means; an integrating capacitor to accumulate charge transferred during multiple consecutive switchings of the series connected switching means; another switching

8

means connected in parallel across the integrating capacitor to deplete its residual charge; and a voltage-to-voltage translation device connected to the output node of the series-connected switching means which produces a voltage representing the magnitude of the self-capacitance of the sensing device. Alternatively, the sensing device comprises: two electrical switching means connected together in series having a common node, an input node, and an output node; a dielectric-covered sensing electrode connected to the common node between the two switching means; a power supply providing an approximately constant voltage connected to the input node of the series-connected switching means; and an integrating current-to-voltage translation device connected to the output node of the series connected switching means, the current-to-voltage translation device producing a voltage representing the magnitude of the self-capacitance of the sensing device.

To further achieve the objects, the present invention comprises a multi-touch surface apparatus for detecting a spatial arrangement of multiple touch devices on or near the surface of the multi-touch apparatus, comprising: one of a rigid or flexible surface; a plurality of two-dimensional arrays of one of the sensing devices (recited in the previous paragraph) arranged on the surface in groups wherein the sensing devices within a group have their output nodes connected together and share the same integrating capacitor, charge depletion switch, and voltage-to-voltage translation circuitry; control circuitry for enabling a single sensor device from each two-dimensional array; means for selecting the sensor voltage data from each two-dimensional array; voltage measurement circuitry to convert sensor voltage data to a digital code; and circuitry for communicating the digital code to another electronic device. The sensor voltage data selecting means comprises one of a multiplexing circuitry and a plurality of voltage measurement circuits.

To still further achieve the objects, the present invention comprises a multi-touch surface apparatus for sensing diverse configurations and activities of touch devices and generating integrated manual input to one of an electronic or electromechanical device, the apparatus comprising: an array of one of the proximity sensing devices described above; a dielectric cover having symbols printed thereon that represent action-to-be-taken when engaged by the touch devices; scanning means for forming digital proximity images from the array of sensing devices; calibrating means for removing background offsets from the proximity images; recognition means for interpreting the configurations and activities of the touch devices that make up the proximity images; processing means for generating input signals in response to particular touch device configurations and motions; and communication means for sending the input signals to the electronic or electromechanical device.

To even further achieve the objects, the present invention comprises a multi-touch surface apparatus for sensing diverse configurations and activities of fingers and palms of one or more hands near the surface and generating integrated manual input to one of an electronic or electromechanical device, the apparatus comprising: an array of proximity sensing means embedded in the surface; scanning means for forming digital proximity images from the proximities measured by the sensing means; image segmentation means for collecting into groups those proximity image pixels intensified by contact of the same distinguishable part of a hand; contact tracking means for parameterizing hand contact features and trajectories as the contacts move across successive proximity images, contact identification means for determining which hand and which part of the hand is causing each surface contact; syn-

US 7,812,828 B2

9

chronization detection means for identifying subsets of identified contacts which touchdown or liftoff the surface at approximately the same time, and for generating command signals in response to synchronous taps of multiple fingers on the surface; typing recognition means for generating intended key symbols from asynchronous finger taps; motion component extraction means for compressing multiple degrees of freedom of multiple fingers into degrees of freedom common in two and three dimensional graphical manipulation; chord motion recognition means for generating one of command and cursor manipulation signals in response to motion in one or more extracted degrees of freedom by a selected combination of fingers; pen grip detection means for recognizing contact arrangements which resemble the configuration of the hand when gripping a pen, generating inking signals from motions of the inner fingers, and generating cursor manipulation signals from motions of the palms while the inner fingers are lifted; and communication means for sending the sensed configurations and activities of finger and palms to one of the electronic and electromechanical device.

To further achieve the objects, the present invention comprises a method for tracking and identifying hand contacts in a sequence of proximity images in order to support interpretation of hand configurations and activities related to typing, multiple degree-of-freedom manipulation via chords, and handwriting, the method comprising the steps of: segmenting each proximity image into groups of electrodes which indicate significant proximity, each group representing proximity of a distinguishable hand part or other touch device; extracting total proximity, position, shape, size, and orientation parameters from each group of electrodes; tracking group paths through successive proximity images including detection of path endpoints at contact touchdown and liftoff; computing velocity and filtered position vectors along each path; assigning a hand and finger identity to each contact path by incorporating relative path positions and velocities, individual contact features, and previous estimates of hand and finger positions; and maintaining estimates of hand and finger positions from trajectories of paths currently assigned to the fingers, wherein the estimates provide high level feedback to bias segmentations and identifications in future images.

To still further achieve the objects, the present invention comprises a method for integrally extracting multiple degrees of freedom of hand motion from sliding motions of two or more fingers of a hand across a multi-touch surface, one of the fingers preferably being the opposable thumb, the method comprising the steps of: tracking across successive scans of the proximity sensor array the trajectories of individual hand parts on the surface; finding an innermost and an outermost finger contact from contacts identified as fingers on the given hand; computing a scaling velocity component from a change in a distance between the innermost and outermost finger contacts; computing a rotational velocity component from a change in a vector angle between the innermost and outermost finger contacts; computing a translation weighting for each contacting finger; computing translational velocity components in two dimensions from a translation weighted average of the finger velocities tangential to surface; suppressively filtering components whose speeds are consistently lower than the fastest components; transmitting the filtered velocity components as control signals to an electronic or electromechanical device.

To even further achieve the objects, the present invention comprises a manual input integration method for supporting diverse hand input activities such as resting the hands, typing, multiple degree-of-freedom manipulation, command gesturing and handwriting on a multi-touch surface, the method

10

enabling users to instantaneously switch between the input activities by placing their hands in different configurations comprising distinguishable combinations of relative hand contact timing, proximity, shape, size, position, motion and/or identity across a succession of surface proximity images, the method comprising the steps of: tracking each touching hand part across successive proximity images; measuring the times when each hand part touches down and lifts off the surface; detecting when hand parts touch down or lift off simultaneously; producing discrete key symbols when the user asynchronously taps, holds, or slides a finger on key regions defined on the surface; producing discrete mouse button click commands, key commands, or no signals when the user synchronously taps two or more fingers from the same hand on the surface; producing gesture commands or multiple degree-of-freedom manipulation signals when the user slides two or more fingers across the surface; and sending the produced symbols, commands and manipulation signals as input to an electronic or an electro-mechanical device.

To still even further achieve the objects, the present invention comprises a method for choosing what kinds of input signals will be generated and sent to an electronic or electro-mechanical device in response to tapping or sliding of fingers on a multi-touch surface, the method comprising the following steps: identifying each contact on the surface as either a thumb, fingertip or palm; measuring the times when each hand part touches down and lifts off the surface; forming a set of those fingers which touch down from the all finger floating state before any one of the fingers lifts back off the surface; choosing the kinds of input signals to be generated by further distinctive motion of the fingers from the combination of finger identities in the set; generating input signals of this kind when further distinctive motions of the fingers occur; forming a subset any two or more fingers which touch down synchronously after at least one finger has lifted back off the surface; choosing a new kinds of input signals to be generated by further distinctive motion of the fingers from the combination of finger identities in the subset; generating input signals of this new kind when further distinctive motions of the fingers occur; and continuing to form new subsets, choose and generate new kinds of input signals in response to liftoff and synchronous touchdowns until all fingers lift off the surface.

To further achieve the objects, the present invention comprises a method for continuing generation of cursor movement or scrolling signals from a tangential motion of a touch device over a touch-sensitive input device surface after touch device liftoff from the surface if the touch device operator indicates that cursor movement continuation is desired by accelerating or failing to decelerate the tangential motion of the touch device before the touch device is lifted, the method comprising the following steps: measuring, storing and transmitting to a computing device two or more representative tangential velocities during touch device manipulation; computing and storing a liftoff velocity from touch device positions immediately prior to the touch device liftoff; comparing the liftoff velocity with the representative tangential velocities, and entering a mode for continuously moving the cursor if a tangential liftoff direction approximately equals the representative tangential directions and a tangential liftoff speed is greater than a predetermined fractional multiple of representative tangential speeds; continuously transmitting cursor movement signals after liftoff to a computing device such that the cursor movement velocity corresponds to one of the representative tangential velocities; and ceasing transmission of the cursor movement signals when the touch device engages the surface again, if comparing means detects significant

11

deceleration before liftoff, or if the computing device replies that the cursor can move no farther or a window can scroll no farther.

It is to be understood that both the foregoing general description and the following detailed description are exemplary and explanatory only and are not restrictive of the invention as claimed.

BRIEF DESCRIPTION OF THE DRAWINGS

The accompanying drawings, which are incorporated in and constitute a part of this specification, illustrate several embodiments of the invention and together with the description, serve to explain the principles of the invention. In the drawings:

FIG. 1 is a block diagram of the integrated manual input apparatus;

FIG. 2 is a schematic drawing of the proximity sensor with voltage amplifier;

FIG. 3 is a schematic drawing of the proximity sensor with integrating current amplifier;

FIG. 4 is a schematic drawing of the proximity sensor implemented with field effect transistors;

FIG. 5 is a schematic drawing of the proximity sensor as used to implement 2D arrays of proximity sensors;

FIG. 6 is a block diagram showing a typical architecture for a 2D array of proximity sensors where all sensors share the same amplifier;

FIG. 7 is a block diagram of circuitry used to convert proximity sensor output to a digital code;

FIG. 8 is a block diagram showing a typical architecture for a 2D array of proximity sensors where sensors within a row share the same amplifier;

FIG. 9 is a schematic of a circuit useful for enabling the output gates of all proximity sensors within a group (arranged in columns);

FIG. 10 is a side view of a 2D proximity sensor array that is sensitive to the pressure exerted by non-conducting touch objects;

FIG. 11 is a side view of a 2D proximity sensor array that provides a compliant surface without loss of spatial sensitivity;

FIG. 12 is a side view of a 2D proximity sensor array that is sensitive to both the proximity of conducting touch objects and to the pressure exerted by non-conducting touch objects;

FIG. 13 is an example proximity image of a hand flattened onto the surface with fingers outstretched;

FIG. 14 is an example proximity image of a hand partially closed with fingertips normal to surface;

FIG. 15 is an example proximity image of a hand in the pen grip configuration with thumb and index fingers pinched;

FIG. 16 is a data flow diagram of the hand tracking and contact identification system;

FIG. 17 is a flow chart of hand position estimation;

FIG. 18 is a data flow diagram of proximity image segmentation;

FIG. 19 is a diagram of the boundary search pattern during construction of an electrode group;

FIG. 20A is a diagram of the segmentation strictness regions with both hands in their neutral, default position on surface;

FIG. 20B is a diagram of the segmentation strictness regions when the hands are in asymmetric positions on surface;

FIG. 20C is a diagram of the segmentation strictness regions when the right hand crosses to the left half of the surface and the left hand is off the surface;

12

FIG. 21 is a flow chart of segmentation edge testing;

FIG. 22 is a flow chart of persistent path tracking;

FIG. 23 is a flow chart of the hand part identification algorithm;

FIG. 24 is a Voronoi cell diagram constructed around hand part attractor points;

FIG. 25A is a plot of orientation weighting factor for right thumb, right inner palm, and left outer palm versus contact orientation;

FIG. 25B is a plot of thumb size factor versus contact size;

FIG. 25C is a plot of palm size factor versus ratio of total contact proximity to contact eccentricity;

FIG. 25D is a plot of palm separation factor versus distance between a contact and its nearest neighbor contact;

FIG. 26 is a flow chart of the thumb presence verification algorithm;

FIG. 27 is a flow chart of an alternative hand part identification algorithm;

FIG. 28 is a flow chart of the pen grip detection process;

FIG. 29 is a flow chart of the hand identification algorithm;

FIGS. 30A-C show three different hand partition hypotheses for a fixed arrangement of surface contacts;

FIG. 31A is a plot of the hand clutching direction factor versus horizontal hand velocity;

FIG. 31B is a plot of the handedness factor versus vertical position of outermost finger relative to next outermost;

FIG. 31C is a plot of the palm cohesion factor versus maximum horizontal separation between palm contacts within a hand;

FIG. 32 is a plot of the inner finger angle factor versus the angle between the innermost and next innermost finger contacts;

FIG. 33 is a plot of the inter-hand separation factor versus the estimated distance between the right thumb and left thumb;

FIG. 34 is a flow chart of hand motion component extraction;

FIG. 35 is a diagram of typical finger trajectories when hand is contracting;

FIG. 36 is a flow chart of radial and angular hand velocity extraction;

FIG. 37 is a flow chart showing extraction of translational hand velocity components;

FIG. 38 is a flow chart of differential hand pressure extraction;

FIG. 39A is a flow chart of the finger synchronization detection loop;

FIG. 39B is a flow chart of chord tap detection;

FIG. 40A is a flow chart of the chord motion recognition loop;

FIG. 40B is a flow chart of chord motion event generation;

FIG. 41 is a flow chart of key layout morphing;

FIG. 42 is a flow chart of the keypress detection loop;

FIG. 43A is a flow chart of the keypress acceptance and transmission loop; and

FIG. 43B is a flow chart of typematic emulation.

DESCRIPTION OF THE PREFERRED EMBODIMENTS

Reference will now be made in detail to the present preferred embodiments of the invention, examples of which are illustrated in the accompanying drawings. Wherever possible the same reference numbers will be used throughout the drawings to refer to the same or like parts.

FIG. 1 is a system block diagram of the entire, integrated manual input apparatus. Sensor embedded in the multi-touch

US 7,812,828 B2

13

surface 2 detect proximity of entire flattened hands 4, fingertips thumbs, palms, and other conductive touch devices to the surface 2. In a preferred embodiment, the surface is large enough to comfortably accommodate both hands 4 and is arched to reduce forearm pronation.

In alternative embodiments the multi-touch surface 2 may be large enough to accommodate motion of one hand, but may be flexible so it can be fitted to an armrest or clothing.

Electronic scanning hardware 6 controls and reads from each proximity sensor of a sensor array. A calibration module 8 constructs a raw proximity image from a complete scan of the sensor array and subtracts off any background sensor offsets. The background sensor offsets can simply be a proximity image taken when nothing is touching the surface.

The offset-corrected proximity image is then passed on to the contact tracking and identification module 10, which segments the image into distinguishable hand-surface contacts, tracks and identifies them as they move through successive images.

The paths of identified contacts are passed on to a typing recognizer module 12, finger synchronization detection module 14, motion component extraction module 16, and pen grip detection module 17, which contain software algorithms to distinguish hand configurations and respond to detected hand motions.

The typing recognizer module 12 responds to quick presses and releases of fingers which are largely asynchronous with respect to the activity of other fingers on the same hand. It attempts to find the key region nearest to the location of each finger tap and forwards the key symbols or commands associated with the nearest key region to the communication interface module 20.

The finger synchronization detector 14 checks the finger activity within a hand for simultaneous presses or releases of a subset of fingers. When such simultaneous activity is detected it signals the typing recognizer to ignore or cancel keystroke processing for fingers contained in the synchronous subset. It also passes on the combination of finger identities in the synchronous subset to the chord motion recognizer 18.

The motion component extraction module 16 computes multiple degrees of freedom of control from individual finger motions during easily performable hand manipulations on the surface 2, such as hand translations, hand rotation about the wrist, hand scaling by grasping with the fingers, and differential hand tilting.

The chord motion recognizer produces chord tap or motion events dependent upon both the synchronized finger subset identified by the synchronization detector 14 and on the direction and speed of motion extracted in 16. These events are then posted to the host communication interface 20.

The pen grip detection module 17 checks for specific arrangements of identified hand contacts which indicate the hand is configured as if gripping a pen. If such an arrangement is detected, it forwards the movements of the gripping fingers as inking events to the host communication interface 20. These inking events can either lay digital ink on the host computer display for drawing or signature capture purposes, or they can be further interpreted by handwriting recognition software which is well known in the art. The detailed steps within each of the above modules will be further described later.

The host communication interface keeps events from both the typing recognizer 12 and chord motion recognizer 18 in a single temporally ordered queue and dispatches them to the host computer system 22. The method of communication between the interface 20 and host computer system 22 can

14

vary widely depending on the function and processing power of the host computer. In a preferred embodiment, the communication would take place over computer cables via industry standard protocols such as Apple Desktop Bus, PS/2 keyboard and mouse protocol for PCs, or Universal Serial Bus (USB). In alternative embodiments the software processing of modules 10-18 would be performed within the host computer 22. The multi-touch surface apparatus would only contain enough hardware to scan the proximity sensor array 6, form proximity images 8, and compress and send them to the host computer over a wireless network. The host communication interface 20 would then play the role of device driver on the host computer, conveying results of the proximity image recognition process as input to other applications residing on the host computer system 22.

In a preferred embodiment the host computer system outputs to a visual display device 24 so that the hands and fingers 4 can manipulate graphical objects on the display screen. However, in alternative embodiments the host computer might output to an audio display or control a machine such as a robot.

The term "proximity" will only be used in reference to the distance or pressure between a touch device such as a finger and the surface 2, not in reference to the distance between adjacent fingers. "Horizontal" and "vertical" refer to x and y directional axes within the surface plane. Proximity measurements are then interpreted as pressure in a z axis normal to the surface. The direction "inner" means toward the thumb of a given hand, and the direction "outer" means towards the pinky finger of a given hand. For the purposes of this description, the thumb is considered a finger unless otherwise noted, but it does not count as a fingertip. "Contact" is used as a general term for a hand part when it touches the surface and appears in the current proximity image, and for the group and path data structures which represent it.

FIG. 2 is a schematic diagram of a device that outputs a voltage 58 dependent on the proximity of a touch device 38 to a conductive sense electrode 33. The proximity sensing device includes two electrical switching means 30 and 31 connected together in series having a common node 48, an input node 46, and an output node 45. A thin dielectric material 32 covers the sensing electrode 33 that is electrically connected to the common node 48. A power supply 34 providing an approximately constant voltage is connected between reference ground and the input node 46. The two electrical switches 30 and 31 gate the flow of charge from the power supply 34 to an integrating capacitor 37. The voltage across the integrating capacitor 37 is translated to another voltage 58 by a high-impedance voltage amplifier 35. The plates of the integrating capacitor 37 can be discharged by closing electrical switch 36 until the voltage across the integrating capacitor 37 is near zero. The electrical switches 30 and 31 are opened and closed in sequence but are never closed at the same time, although they may be opened at the same time as shown in FIG. 2. Electrical switch 30 is referred to as the input switch; electrical switch 31 is referred to as the output switch; and, electrical switch 36 is referred to as the shorting switch.

The proximity sensing device shown in FIG. 2 is operated by closing and opening the electrical switches 30, 31, and 36 in a particular sequence after which the voltage output from the amplifier 58, which is dependent on the proximity of a touch device 38, is recorded. Sensor operation begins with all switches in the open state as shown in FIG. 2. The shorting switch 36 is then closed for a sufficiently long time to reduce the charge residing on the integrating capacitor 37 to a low level. The shorting switch 37 is then opened. The input switch

15

30 is then closed thus allowing charge to flow between the power supply and the common node 48 until the voltage across the input switch 30 becomes zero. Charge Q will accumulate on the sensing electrode 33 according to

$$Q = V(e^*A)D \quad (1)$$

where V is the voltage of the power supply 34, e is the permittivity of the dielectric sensing electrode cover 32 and the air gap between the cover and the touch device 38, D is the thickness of this dielectric region, and A is the overlap area of the touch device 38 and the sensing electrode 33. Therefore the amount of charge accumulating on the sensing electrode 33 will depend, among other things, on the area of overlap of the touch device 38 and the sensing electrode 33 and the distance between the touch device 38 and the sensing electrode 33. The input switch 30 is opened after the voltage across it has become zero, or nearly so. Soon after input switch 30 is opened the output switch 31 is closed until the voltage across it is nearly zero. Closing the output switch 31 allows charge to flow between the sensing electrode 33 and the integrating capacitor 37 resulting in a voltage change across the integrating capacitor 37 according to:

$$\text{delta } V = (V - V_c) / (1 + C * D / e * A) \quad (2)$$

where Vc is the voltage across the integrating capacitor 37 before the output switch 31 was closed, C is the capacitance of the integrating capacitor 37, and A and D are equal to their values when input switch 30 was closed as shown in Equation 1. Multiple switchings of the input 30 and output 31 switches as described above produce a voltage on the integrating capacitor 37 that reflects the proximity of a touch device 38 to the sensing electrode 33.

FIG. 3A is a schematic diagram of the proximity sensor in which the shorting transistor 36 and the voltage-to-voltage translation device 35 are replaced by a resistor 40 and a current-to-voltage translation device 41, respectively. The integrating function of capacitor 37 shown in FIG. 2 is, in this variation of the proximity sensor, carried out by the capacitor 39 shown in FIG. 3A. Those skilled in the art will see that this variation of the proximity sensor produces a more linear output 58 from multiple switchings of the input and output switches, depending on the relative value of the resistor 40. Alternatively, the resistor 40 can be replaced by a shorting switch 69 (cf. FIG. 3B) to improve linearity. Although, the circuits shown in FIG. 3 provide a more linear output than the circuit shown in FIG. 2 the circuits of FIG. 3 generally require dual power supplies while the circuit of FIG. 2 requires only one.

The electrical switches shown in FIG. 2 can be implemented with various transistor technologies: discrete, integrated, thin film, thick film, polymer, optical, etc. One such implementation is shown in FIG. 4A where field effect transistors (FETs) are used as the input 30, output 31, and shorting 36 switches. The FETs are switched on and off by voltages applied to their gate terminals (43, 44, and 55). For the purpose of this description we will assume the FET is switched on when its gate voltage is logic 1 and switched off when its gate voltage is logic 0. A controller 42 is used to apply gate voltages as a function of time as shown in FIG. 4B. In this example, a sequence of three pairs of pulses (43 and 44) are applied to the input and output transistor gates. Each pair of pulses 43 and 44 produces a voltage change across the integrating capacitor 37 as shown in Equation 2. The number of pulse pairs applied to input 43 and output 44 gates depends on

16

the desired voltage across integrating capacitor 37. In typical applications the number is between one and several hundred pulse-pairs.

FIG. 5 shows the proximity sensor circuitry appropriate for use in a system comprising an array of proximity sensors 47 as in a multi-touch surface system. The proximity sensor 47 consists of the input transistor 30, the output transistor 31, the sensing electrode 33, the dielectric cover 32 for the sensing electrode 33, and conductive traces 43, 44, 45, and 46. The conductive traces are arranged so as to allow the proximity sensors 47 comprising a 2D array to be closely packed and to share the same conductive traces, thus reducing the number of wires needed in a system. FIG. 6 shows an example of such a system where the input nodes 46 of all proximity sensors are connected together and connected to a power supply 34. The output nodes 45 of all proximity sensors are connected together and connected to a single integrating capacitor 37, a single shorting transistor 36, and a single voltage-to-voltage amplifier 35. In this implementation, a single proximity sensor 47 is enabled at a time by applying a logic 1 signal first to its input gate 43 and then to its output gate 44. This gating of a single proximity sensor 47 one at a time is done by input gate controller 50 and output gate controller 51. For example, to enable the proximity sensor 47 in the lower right corner the input gate controller 50 would output a logic one pulse on conductive trace 43a. This is followed by a logic one pulse on conductive trace 44h produced by output gate controller 51. Repetition of this pulse as shown in FIG. 4B would cause charge to build up on integrating capacitor 37 and a corresponding voltage to appear at the output of the amplifier 58. The entire array of proximity sensors 47 is thus scanned by enabling a single sensor at a time and recording its output.

FIG. 7A is a schematic of typical circuitry useful for converting the proximity sensor output 58 to a digital code appropriate for processing by computer. The proximity sensor output 58 is typically non-zero even when there is no touch signal (e.g., ref. no. 38 in FIG. 2) nearby. This non-zero signal is due to parasitic or stray capacitance present at the common node 48 of the proximity sensor and is of relatively constant value. It is desirable to remove this non-zero background signal before converting the sensor output 58 to a digital code. This is done by using a differential amplifier 64 to subtract a stored record of the background signal 68 from the sensor output 58. The resulting difference signal 65 is then converted to a digital code by an ADC (analog to digital converter) 60 producing a K-bit code 66. The stored background signal is first recorded by sampling the array of proximity sensors 47 (FIG. 6) with no touch devices nearby and storing a digital code specific for each proximity sensor 47 in a memory device 63. The particular code corresponding to the background signal of each proximity sensor is selected by an M-bit address input 70 to the memory device 63 and applied 69 to a DAC (digital to analog converter) 61.

The 2D array of proximity sensors 47 shown in FIG. 6 can be connected in groups so as to improve the rate at which the entire array is scanned. This is illustrated in FIG. 8 where the groups are arranged as columns of proximity sensors. In this approach, the input nodes of the proximity sensors are connected together and connected to a power supply 34, as in FIG. 6. The output gates 44 are also connected in the same way. However, the input gates 43 are now all connected together and the output nodes 45 are connected to only those proximity sensors 47 within a row and to a dedicated voltage amplifier 35. With this connection method, all of the proximity sensors in a column are enabled at a time, thus reducing the time to scan the array by a factor N, where N is the number of proximity sensors in a group. The outputs 58a-h could con-

17

nect to dedicated converter circuitry as shown in FIG. 7A or alternatively each output 58a-h could be converted one at a time using the circuitry shown in FIG. 7B. In this figure, the output signals from each group 58a-h are selected one at a time by multiplexer 62 and applied to the positive input of the differential amplifier 64. With this later approach, it is assumed that the ADC 60 conversion time is much faster than the sensor enable time, thus providing the suggested speed up in sensor array scanning.

FIG. 9 shows a typical circuit useful for the control of the proximity sensor's output gate 44. It consists of three input signals 75, 76, 78 and two output signals 44, 77. The output gate signal 44 is logic 1 when both inputs to AND gate 79 are logic 1. The AND input signal 77 becomes logic 1 if input signal 76 is logic 1 when input signal 78 transitions from logic 0 to logic 1, otherwise it remains logic 0. A linear array of these circuits 81 can be connected end-to-end to enable the output gates of a single group of proximity sensors at a time as shown in FIG. 8.

FIG. 10 shows a cover for the multi-touch surface 89 that permits the system to be sensitive to pressure exerted by non-conducting touch objects (e.g., gloved fingers) contacting the multi-touch surface. This cover comprises a deformable dielectric touch layer 85, a deformable conducting layer 86, and a compliant dielectric layer 87. The touch surface 85 would have a symbol set printed on it appropriate for a specific application, and this surface could be removed and replaced with another one having a different symbol set. The conducting layer 86 is electrically connected 88 to the reference ground of the proximity sensor's power supply 34. When a touch object presses on the top surface 85 it causes the conducting surface 86 under the touch device to move closer to the sensing electrode 33 of the proximity sensor. This results in a change in the amount of charge stored on the sensing electrode 33 and thus the presence of the touch object can be detected. The amount of charge stored will depend on the pressure exerted by the touch object. More pressure results in more charge stored as indicated in Equation 1.

To obtain a softer touch surface on the multi-touch device a thicker and more, compliant dielectric cover could be used. However, as the dielectric thickness increases the effect of the touch device on the sensing electrodes 33 spreads out thus lowering spatial resolution. A compliant anisotropically-conducting material can be used to counter this negative effect while also providing a soft touch surface. FIG. 11 shows a cover in which a compliant anisotropically-conducting material 90 is set between a thin dielectric cover 85 and the sensing electrodes 33. If the conductivity of the compliant material 90 is oriented mostly in the vertical direction, the image formed by a touch device on the surface 85 will be translated without significant spreading to the sensing electrodes 33, thus preserving spatial resolution while providing a compliant touch surface.

FIG. 12 shows a cross section of a multi-touch surface that senses both the proximity and pressure of a touch device. The touch layer 85 is a thin dielectric that separates touch devices from the sensing electrodes 33. Proximity sensing is relative to this surface. The electrodes 33 and associated switches and conductors are fabricated on a compliant material 89 which is attached to a rigid metal base 92. The metal base 92 is electrically connected 88 to the reference ground of the proximity sensor's power supply 34. When a touch device presses on the touch surface 85 it causes the sensing electrodes 33 directly below to move closer to the rigid metal base 92. The distance moved depends on the pressure applied and thus the pressure exerted by a touch device can be detected as described before.

18

To illustrate typical properties of hand contacts as they appear in proximity images, FIGS. 13-15 contain sample images captured by a prototype array of parallelogram-shaped electrodes. Shading of each electrode darkens to indicate heightened proximity signals as flesh gets closer to the surface, compresses against the surface due to hand pressure, and overlaps the parallelogram more completely. Note that the resolution of these images is in no way intended to limit the scope of the invention, since certain applications such as handwriting recognition will clearly require finer electrode arrays than indicated by the electrode size in these sample images. In the discussion that follows, the proximity data measured at one electrode during a particular scan cycle constitutes one "pixel" of the proximity image captured in that scan cycle.

FIG. 13 shows a right hand flattened against the surface with fingers outstretched. At the far left is the oblong thumb 201 which tends to point off at about 120-degrees. The columnar blobs arranged in an arc across the top of the image are the index finger 202, middle finger 203, ring finger 204 and pinky finger 205. Flesh from the proximal finger joint, or proximal phalanges 209, will appear below each fingertip if the fingers are fully extended. The inner 207 and outer 206 palm heels cause the pair of very large contacts across the bottom of the image. Forepalm calluses 213 are visible at the center of the hand if the palm is fully flattened. This image shows that all the hand contacts are roughly oval-shaped, but they differ in pressure, size, orientation, eccentricity and spacing relative to one another. This image includes all of the hand parts which can touch the surface from the bottom of one hand but in many instances only a few of these parts will be touching the surface, and the fingertips may roam widely in relation to the palms as fingers are flexed and extended.

FIG. 14 shows another extreme in which the hand is partially closed. The thumb 201 is adducted toward the fingertips 202-208 and the fingers are flexed so the fingertips come down normal instead of tangential to the surface. The height and intensity of fingertip contacts is lessened somewhat because the boney tip rather than fleshy pulp pad is actually touching the surface, but fingertip width remains the same. Adjacent fingertips 202-205 and thumb 201 are so close together as to be distinguishable only by slight proximity valleys 210 between them. The proximal phalange finger joints are suspended well above the surface and do not appear in the image, nor do the forepalm calluses. The palm heels 206, 207 are somewhat shorter since only the rear of the palm can touch the surface when fingers are flexed, but the separation between them is unchanged. Notice that the proximity images are uncluttered by background objects. Unlike optical images, only conductive objects within a few millimeters of the surface show up at all.

FIG. 15 is a proximity image of a right hand in a pen grip configuration. The thumb 201 and index fingertip 202 are pinched together as if they were holding a pen but in this case they are touching the surface instead. Actually the thumb and index finger appear the same here as in FIG. 14. However, the middle 203, ring 204, and pinky 205 fingers are curled under as if making a fist, so the knuckles from the top of the fingers actually touch the surface instead of the finger tips. The curling under of the knuckles actually places them behind the pinched thumb 201 and index fingertip 202 very close to the palm heels 206, 207. The knuckles also appear larger than the curled fingertips of FIG. 14 but the same size as the flattened fingertips in FIG. 13. These differences in size and arrangement will be measured by the pen grip detector 17 to distinguish this pen grip configuration from the closed and flattened hand configurations.

FIG. 16 represents the data flow within the contact tracking and identification module 10. The image segmentation process 241 takes the most recently scanned proximity image data 240 and segments it into groups of electrodes 242 corresponding to the distinguishable hand parts of FIG. 13. The filtering and segmentation rules applied in particular regions of the image are partially determined by feedback of the estimated hand offset data 252. The image segmentation process 241 outputs a set of electrode group data structures 242 which are parameterized by fitting an ellipse to the positions and proximity measurements of the electrodes within each group.

The path tracking process 245 matches up the parameterized electrode groups 242 with the predicted continuations of contact path data structures 243 extracted from previous images. Such path tracking ensures continuity of contact representation across proximity images. This makes it possible to measure the velocity of individual hand contacts and determine when a hand part lifts off the surface, disappearing from future images. The path tracking process 245 updates the path positions, velocities, and contact geometry features from the parameters of the current groups 242 and passes them on to the contact identification processes 247 and 248. For notational purposes, groups and unidentified paths will be referred to by data structure names of the form G_i and P_i respectively, where the indices i are arbitrary except for the null group G_0 and null path P_0 . Particular group and path parameters will be denoted by subscripts to these structure names and image scan cycles will be denoted by bracketed indices, so that, for example, $P_{2,x}[n]$ represents the horizontal position of path 2 in the current proximity image, and $P_{2,x}[n-1]$ represents the position in the previous proximity image. The contact identification system is hierarchically split into a hand identification process 247 and within-hand finger and palm identification process 248. Given a hand identification for each contact, the finger and palm identification process 248 utilizes combinatorial optimization and fuzzy pattern recognition techniques to identify the part of the hand causing each surface contact. Feedback of the estimated hand offset helps identify hand contacts when so few contacts appear in the image that the overall hand structure is not apparent.

The hand identification process 247 utilizes a separate combinatorial optimization algorithm to find the assignment of left or right hand identity to surface contacts which results in the most biomechanically consistent within-hand identifications. It also receives feedback of the estimated hand and finger offsets 252, primarily for the purpose of temporarily storing the last measured hand position after fingers in a hand lift off the surface. Then if the fingers soon touch back down in the same region they will more likely receive their previous hand identifications.

The output of the identification processes 247 and 248 is the set of contact paths with non-zero hand and finger indices attached. For notational purposes identified paths will be referred to as F_0 for the unidentified or null finger, F_1 for the thumb 201, F_2 for the index finger 202, F_3 for the middle finger 203, F_4 for the ring finger 204, F_5 for the pinky finger 205, F_6 the outer palm heel 206, F_7 for the inner palm heel 207, and F_8 for the forepalm calluses 208. To denote a particular hand identity this notation can be prefixed with an L for left hand or R for right hand, so that, for example, RF2 denotes the right index finger path. When referring to a particular hand as a whole. LH denotes the left hand and RH denotes the right hand. In the actual algorithms left hand identity is represented by a -1 and right hand by +1, so it is easy to reverse the handedness of measurements taken across the vertical axis of symmetry.

It is also convenient to maintain for each hand a set of bitfield data registers for which each bit represents touch-down, continued contact or liftoff of a particular finger. Bit positions within each bit field correspond to the hand part indices above. Such registers can quickly be tested with a bit mask to determine whether a particular subset of fingers has touched down. Alternatively, they can be fed into a lookup table to find the input events associated with a particular finger chord (combination of fingers). Such finger identity bitfields are needed primarily by the synchronization detector 14 and chord motion recognizer 18.

The last process within the tracking and identification subsystem is the hand position estimator 251, which as described above provides biasing feedback to the identification and segmentation processes. The hand position estimator is intended to provide a conservative guess 252 of lateral hand position under all conditions including when the hand is floating above the surface without touching. In this case the estimate represents a best guess of where the hand will touch down again. When parts of a hand are touching the surface, the estimate combines the current position measurements of currently identified hand parts with past estimates which may have been made from more or less reliable identifications.

The simplest but inferior method of obtaining a hand position measurement would be to average the positions of all the hand's contacts regardless of identity. If hand parts 201-207 were all touching the surface as in FIG. 13 the resulting centroid would be a decent estimate, lying somewhere under the center of the palm since the fingers and palm heels typically form a ring around the center of the palm. However, consider when only one hand contact is available for the average. The estimate would assume the hand center is at the position of this lone contact, but if the contact is from the right thumb the hand center would actually be 4-8 cm to the right, or if the contact is from a palm heel the hand center is actually 4-6 cm higher, or if the lone contact is from the middle finger the hand center should actually be 4-6 cm lower.

FIG. 17 shows the detailed steps within the hand position estimator 251. The steps must be repeated for each hand separately. In a preferred embodiment, the process utilizes the within-hand contact identifications (250) to compute (step 254) for each contact an offset between the measured contact position ($F_{i_x}[n], F_{i_y}[n]$) and the default position of the particular finger or palm heel ($F_{i_{defx}}, F_{i_{defy}}$) with hand part identity i . The default positions preferably correspond to finger and palm positions when the hand is in a neutral posture with fingers partially closed, as when resting on home row of a keyboard. Step 255 averages the individual contact offsets to obtain a measured hand offset, ($H_{max}[n], H_{may}[n]$):

$$H_{max}[n] = \frac{\sum_{i=1}^{i=7} F_{i_{mow}}[n](F_{i_x}[n] - F_{i_{defx}})}{\sum_{i=1}^{i=7} F_{i_{mow}}[n]} \tag{3}$$

$$H_{may}[n] = \frac{\sum_{i=1}^{i=7} F_{i_{mow}}[n](F_{i_y}[n] - F_{i_{defy}})}{\sum_{i=1}^{i=7} F_{i_{mow}}[n]} \tag{4}$$

Preferably the weighting $F_{i_{mow}}[n]$ of each finger and palm heel is approximately its measured total proximity, i.e., $F_{i_{mow}}[n]=F_{i_z}[n]$. This ensures that lifted fingers, whose proximity is zero, have no influence on the average, and that contacts with

lower than normal proximity, whose measured positions and identities are less accurate, have low influence. Furthermore, if palm heels are touching, their large total proximities will dominate the average. This is beneficial because the palm heels, being immobile relative to the hand center compared to the highly flexible fingers, supply a more reliable indication of overall hand position. When a hand is not touching the surface, i.e., when all proximities are zero, the measured offsets are set to zero. This will cause the filtered hand position estimate below to decay toward the default hand position.

As long as the contact identifications are correct, this hand position measurement method eliminates the large errors caused by assuming lone contacts originate from the center of the hand. Flexing of fingers from their default positions will not perturb the measured centroid more than a couple centimeters. However, this scheme is susceptible to contact misidentification, which can cause centroid measurement errors of up to 8 cm if only one hand part is touching. Therefore, the current measured offsets are not used directly, but are averaged with previous offset estimates ($H_{eox}[n-1], H_{eoy}[n-1]$) using a simple first-order autoregressive filter, forming current offset estimates ($H_{eox}[n], H_{eoy}[n]$).

Step 256 adjusts the filter pole $H_{oa}[n]$ according to confidence in the current contact identifications. Since finger identifications accumulate reliability as more parts of the hand contact the surface one simple measure of identification confidence: is the number of fingers which have touched down from the hand since the hand last left the surface. Contacts with large total proximities also improve identification reliability because they have strong disambiguating features such as size and orientation. Therefore $H_{oa}[n]$ is set roughly proportional to the maximum finger count plus the sum of contact proximities for the hand. $H_{oa}[n]$ must of course be normalized to be between zero and one or the filter will be unstable. Thus when confidence in contact identifications is high, i.e., when many parts of the hand firmly touch the surface, the autoregressive filter favors the current offset measurements. However, when only one or two contacts have reappeared since hand liftoff, the filter emphasizes previous offset estimates in the hope that they were based upon more reliable identifications.

The filtered offsets must also maintain a conservative estimate of hand position while the hand is floating above the surface for optimal segmentation and identification as the hand touches back down. If a hand lifts off the surface in the middle of a complex sequence of operations and must, quickly touch down again, it will probably touch down close to where it lifted off. However, if the operation sequence has ended, the hand is likely to eventually return to the neutral posture, or default position, to rest. Therefore, while a hand is not touching the surface, $H_{oa}[n]$ is made small enough that the estimated offsets gradually decay to zero at about the same rate as a hand lazily returns to default position.

When $H_{oa}[n]$ is made small due to low identification confidence, the filter tracking delay becomes large enough to lag behind a pair of quickly moving fingers by several centimeters. The purpose of the filter is to react slowly to questionable changes in contact identity, not to smooth contact motion. This motion tracking delay can be safely eliminated by adding the contact motion measured between images to the old offset estimate. Step 257 obtains motion from the average, ($H_{mox}[n], H_{moy}[n]$) of the current contact velocities:

$$H_{mox}[n] = \frac{\sum_{i=1}^{i=7} F_{imox}[n] F_{ix}[n]}{\sum_{i=1}^{i=7} F_{imox}[n]} \tag{5}$$

$$H_{moy}[n] = \frac{\sum_{i=1}^{i=7} F_{imoy}[n] F_{iy}[n]}{\sum_{i=1}^{i=7} F_{imoy}[n]} \tag{6}$$

The current contact velocities, ($F_{ix}[n], F_{iy}[n]$), are retrieved from the path tracking process 245, which measures them independent of finger identity. Step 258 updates the estimated hand offsets ($H_{eox}[n], H_{eoy}[n]$) using the complete filter equations:

$$H_{eox}[n] = H_{oa}[n] H_{mox}[n] + (1 - H_{oa}[n]) (H_{eox}[n-1] + H_{mox}[n] \Delta t) \tag{7}$$

$$H_{eoy}[n] = H_{oa}[n] H_{moy}[n] + (1 - H_{oa}[n]) (H_{eoy}[n-1] + H_{moy}[n] \Delta t) \tag{8}$$

Finally, to provide a similarly conservative estimate of the positions of particular fingers step 259 computes individual finger offsets ($F_{eox}[n], F_{eoy}[n]$) from the distance between identified contacts and their corresponding default finger positions less the estimated hand offsets. For each identifiable contact i , the offsets are computed as:

$$F_{eox}[n] = H_{oa}[n] (H_{max}[n] + F_{ix}[n] - F_{defx}) + (1 - H_{oa}[n]) (F_{eox}[n-1] + F_{ix}[n] \Delta t) \tag{9}$$

$$F_{eoy}[n] = H_{oa}[n] (H_{max}[n] + F_{iy}[n] - F_{defy}) + (1 - H_{oa}[n]) (F_{eoy}[n-1] + F_{iy}[n] \Delta t) \tag{10}$$

These finger offsets reflect deviations of finger flexion and extension from the neutral posture. If the user places the fingers in an extreme configuration such as the flattened hand configuration, the collective magnitudes of these finger offsets can be used as an indication of user hand size and finger length compared to the average adult.

The parameters ($H_{eox}[n], H_{eoy}[n]$) and ($F_{eox}[n], F_{eoy}[n]$) for each hand and finger constitute the estimated hand and finger offset data 252, which is fed back to the segmentation and identification processes during analysis of the next proximity image. If the other processes need the estimate in absolute coordinates, they can simply add (step 260) the supplied offsets to the default finger positions, but in many cases the relative offset representation is actually more convenient.

It should be clear to those skilled in the art that many improvements can be made to the above hand position estimation procedure which remain well within the scope of this invention, especially in the manner of guessing the position of lifted hands. One improvement is to make the estimated hand offsets decay toward zero at a constant speed when a hand is lifted rather than decay exponentially. Also, the offset computations for each hand have been independent as described so far. It is actually advantageous to impose a minimum horizontal separation between the estimated left hand position and estimated right hand position such that when a hand such as the right hand slides to the opposite side of the board while the other hand is lifted, the estimated position of the other hand is displaced. In this case the estimated position of the lifted left hand would be forced from default to the far left of the surface, possibly off the surface completely. If the right hand is lifted and the left is not, an equation like the following can be applied to force the estimated right hand position out of the way:

23

$$R_{h_{\text{est}}}[n] = \min(R_{H_{\text{est}}}[n], (LF1_{\text{defx}} - RF1_{\text{defx}}) + LH_{\text{est}}[n] + \min_{\text{hard_sep}}) \quad (11)$$

where $(LF1_{\text{defx}} - RF1_{\text{defx}})$ is the default separation between left and right thumbs, $\min_{\text{hard_sep}}$ is the minimum horizontal separation to be imposed, and $LH_{\text{est}}[n]$ is the current estimated offset of the left hand.

FIG. 18 represents the data flow within the proximity image segmentation process 241. Step 262 makes a spatially smoothed copy 263 of the current proximity image 240 by passing a two-dimensional diffusion operator or Gaussian kernel over it. Step 264 searches the smoothed image 263 for local maximum pixels 265 whose filtered proximity exceeds a significance threshold and exceeds the filtered proximities of nearest neighbor pixels. The smoothing reduces the chance that an isolated noise spike on a single electrode will result in a local maximum-which exceeds the significance threshold, and consolidates local maxima to about one per distinguishable fleshy contact.

Process 268 then constructs a group of electrodes or pixels which register significant proximity around each local maximum pixel by searching outward from each local maximum for contact edges. Each electrode encountered before reaching a contact boundary is added to the local maximum's group. FIG. 19 shows the basic boundary electrode search pattern for an example contact boundary 274. In this diagram, an electrode or image pixel lies at the tip of each arrow. The search starts at the local maximum pixel 276, proceeds to the left pixels 277 until the boundary 274 is detected. The last pixel before the boundary 278 is marked as an edge pixel, and the search resumes to the right 279 of the local maximum pixel 276. Once the left and right edges of the local maximum's row have been found, the search recurses to the rows above and below, always starting 281 in the column of the pixel in the previous row which had the greatest proximity. As the example illustrates, the resulting set of pixels or electrodes is connected in the mathematical sense but need not be rectangular. This allows groups to closely fit the typical oval-shape of flesh contacts without leaving electrodes out or including those from adjacent contacts.

If contacts were small and always well separated, edges could simply be established wherever proximity readings fell to the background level. But sometimes fingertips are only separated by a slight valley or shallow saddle point 210. To segment adjacent fingertips the partial minima of these valleys must be detected and used as group boundaries. Large palm heel contacts, on the other hand, may exhibit partial minima due to minor nonuniformities in flesh proximity across the contact. If all electrodes under the contact are to be collected in a single group, such partial minima must be ignored. Given a hand position estimate the segmentation system can apply strict edge detection rules in regions of the image where fingertips and thumb are expected to appear but apply sloppy edge detection rules in regions of the image where palms are expected to, appear. This ensures that adjacent fingertips are not joined into a single group and that each palm heel is not broken into multiple groups.

Step 266 of FIG. 18 defines the positions of these segmentation regions using the hand position estimates 252 derived from analyses of previous images. FIG. 20A shows the extent of the strict and sloppy segmentation regions while the hands are in their default positions, making estimated offsets for both hands zero. Plus signs in the diagram 252 indicate the estimated position of each finger and palm heel in each hand. Rectangular outlines in the lower corners represent the left 284 and right 286 sloppy segmentation regions where partial minima are largely ignored. The T-shaped region remaining is

24

the strict segmentation region 282, where proximity saddle points must serve as contact boundaries. As a preferred embodiment the sloppy regions are rectangular, their inner boundaries 285 are placed just inside of the columns where the index fingers 202 are expected to lie, and the upper boundaries 287 are placed at the estimated vertical levels of their respective thumbs 201. The outer and lower boundaries of the sloppy regions are determined by the outside edges of the surface. Due to the decay in estimated hand offsets after hands leave the surface, the sloppy segmentation regions return to the positions shown after the hands have stayed off the surface a few seconds, regardless of hand position at liftoff. FIG. 20B shows how the sloppy regions follow the estimated hand positions 252 as the right hand moves toward the upper left and the left hand moves toward the lower left. This ensures that the palms and only the palms fall in the sloppy regions as long as the hand position estimates are correct.

FIG. 20C shows that the left sloppy region 284 is moved left off the surface entirely when the left hand is lifted off the surface and the right hand slides to the left side of the surface. This prevents the fingers of one hand from entering the sloppy segmentation region of the opposite hand. This effect is implemented by imposing a minimum horizontal separation between the sloppy regions and, should the regions get too close to one another, letting the hand with the most surface contacts override the estimated position of the hand with fewer contacts. FIG. 21 is a detailed flow chart of the edge tests which are applied at each searched electrode depending on whether the electrode is in a strict or sloppy segmentation region. Decision diamond 290 checks whether the unsmoothed proximity of the electrode is greater than the background proximity levels. If not, the electrode is labeled an edge electrode in step 304 regardless of the segmentation region or search direction, and in step 305 the search returns to the row maximum to recurse in another direction. If the unsmoothed proximity is significant farther tests are applied to the smoothed proximity of neighboring electrodes depending on whether decision diamond 292 decides the search electrode is in a sloppy or strict region.

If a strict region search is advancing horizontally within a row, decision diamond 306 passes to decision diamond 308 which tests whether the electrode lies in a horizontal or diagonal partial minimum with respect to its nearest neighbor electrodes. If so, a proximity valley between adjacent fingers has probably been detected, the electrode is labeled as an edge 314 and search resumes in other directions 305. If not, the search continues on the next electrode in the row 302. If a strict region search is advancing vertically to the next row, decision diamond 306 passes to decision diamond 310 which tests whether the electrode lies in a vertical partial minimum with respect to the smoothed proximity of its nearest neighbor electrodes. If so, a proximity valley between a finger and the thumb has probably been detected, the electrode is labeled as an edge 312 and search resumes in other directions 305. If not, the search continues into the next row 302. If decision diamond 294 determines that a sloppy region search is advancing horizontally within a row, stringent horizontal minimum tests are performed to check for the crease or proximity valley between the inner and outer palm heels. To qualify, the electrode must be more than about 2 cm horizontal distance from the originating local maximum, as checked by decision diamond 296. Also the electrode must be part of a tall valley or partial horizontal minimum which extends to the rows above and below and the next-nearest neighbors within the row, as checked by decision diamond 298. If so, the electrode is labeled as an edge 300 and search recurses in other directions 305. All other partial minima within the sloppy regions are

ignored, so the search continues 302 until a background level edge is reached on an upcoming electrode.

In sloppy segmentation regions it is possible for groups to overlap significantly because partial minima between local maxima do not act as boundaries. Typically when this happens the overlapping groups are part of a large fleshy contact such as a palm which, even after smoothing, has multiple local maxima. Two groups are defined to be overlapping if the search originating local maximum electrode of one group is also an element of the other group. In the interest of presenting only one group per distinguishable fleshy contact to the rest of the system, step 270 of FIG. 18 combines overlapping groups into single supergroups before parameter extraction. Those skilled in the art will realize that feedback from high-level analysis of previous images can be applied in various alternative ways to improve the segmentation process and still lie well within the scope of this invention. For example, additional image smoothing in sloppy segmentation regions could consolidate each palm heel contact into a single local maximum which would pass strict segmentation region boundary tests. Care must be taken with this approach however, because too much smoothing can cause finger pairs which unexpectedly enter sloppy palm regions to be joined into one group. Once a finger pair is joined the finger identification process 248 has no way to tell that the fingertips are actually not a single palm heel, so the finger identification process will be unable to correct the hand position estimate or adjust the sloppy regions for proper segmentation of future images.

More detailed forms of feedback than the hand position estimate can be utilized as well. For example, the proximal phalanges (209 in FIG. 13) are actually part of the finger but tend to be segmented into separate groups than the fingertips by the vertical minimum test 310. The vertical minimum test is necessary to separate the thumb group from index fingertip group in the partially closed FIG. 14 and pen grip FIG. 15 hand configurations. However, the proximal phalanges of flattened fingers can be distinguished from a thumb behind a curled fingertip by the fact that it is very difficult to flatten one long finger without flattening the other long fingers. To take advantage of this constraint, a flattened finger flag 267 is set whenever two or more of the contacts identified as index through pinky in previous images are larger than normal, reliably indicating that fingertips are flattening. Then decision diamond 310 is modified during processing of the current image to ignore the first vertical minimum encountered during search of rows below the originating local minimum 276. This allows the proximal phalanges to be included in the fingertip group but prevents fingertip groups from merging with thumbs or forepalms. The last step 272 of the segmentation process is to extract shape, size, and position parameters from each electrode group. Group position reflects hand contact position and is necessary to determine finger velocity. The total group proximity, eccentricity, and orientation are used by higher level modules to help distinguish finger, palm, and thumb contacts.

Provided G_E is the set of electrodes in group G , e_z is the unsmoothed proximity of an electrode or pixel e , and e_x and e_y are the coordinates on the surface of the electrode center in centimeters, to give a basic indicator of group position, the proximity-weighted center, or centroid, is computed from positions and proximities of the group's electrodes:

$$G_z = \sum_{e \in G_E} e_z \tag{12}$$

$$G_x = \sum_{e \in G_E} \frac{e_z e_x}{G_z} \tag{13}$$

$$G_y = \sum_{e \in G_E} \frac{e_z e_y}{G_z} \tag{14}$$

Note that since the total group proximity G_z integrates proximity over each pixel in the group, it depends upon both of the size of a hand part, since large hand parts tend to cause groups with more pixels, and of the proximity to or pressure on the surface of a hand part.

Since most groups are convex, their shape is well approximated by ellipse parameters. The ellipse fitting procedure requires a unitary transformation of the group covariance matrix G_{cov} of second moments Q_{xx} , Q_{xy} , G_{yy} :

$$G_{cov} = \begin{bmatrix} G_{xx} & G_{xy} \\ G_{yx} & G_{yy} \end{bmatrix} \tag{15}$$

$$G_{xx} = \sum_{e \in G_E} e_z (G_z - e_x)^2 \tag{16}$$

$$G_{yx} = G_{xy} = \sum_{e \in G_E} e_z (G_z - e_x)(G_y - e_y) \tag{17}$$

$$G_{yy} = \sum_{e \in G_E} e_z (G_y - e_y)^2 \tag{18}$$

The eigenvalues λ_0 and λ_1 of the covariance matrix G_{cov} determine the ellipse axis lengths and orientation G_θ :

$$G_{major} = \sqrt{\lambda_0} \tag{19}$$

$$G_{minor} = \sqrt{\lambda_1} \tag{20}$$

$$G_\theta = \arctan\left(\frac{\lambda_0 - G_{xx}}{G_{xy}}\right) \tag{21}$$

where G_θ is uniquely wrapped into the range $(0, 180^\circ)$.

For convenience while distinguishing fingertips from palms at higher system levels, the major and minor axis lengths are converted via their ratio into an eccentricity G_E :

$$G_E = \frac{G_{major}}{G_{minor}} \tag{22}$$

Note that since the major axis length is always greater than or equal to the minor axis length, the eccentricity will always be greater than or equal to one. Finally, the total group proximity is empirically renormalized so that the typical curled fingertip will have a total proximity around one:

$$G_z := \frac{G_z}{Z_{averageFingertip}} \tag{23}$$

On low resolution electrode arrays, the total group proximity G_z is a more reliable indicator of contact size as well as finger pressure than the fitted ellipse parameters. Therefore, if proximity images have low resolution, the orientation and eccentricity of small contacts are set to default values rather than their measured values, and total group proximity G_z is used as the primary measure of contact size instead of major and minor axis lengths.

FIG. 22 shows the steps of the path tracking process, which chains together those groups from successive proximity images which correspond to the same physical hand contact. To determine where each hand part has moved since the last proximity image, the tracking process must decide which current groups should be matched with which existing contact paths. As a general rule, a group and path arising from the same contact will be closer to one another than to other groups and paths. Also, biomechanical constraints on lateral finger velocity and acceleration limit how far a finger can travel between images. Therefore a group and path should not be matched unless they are within a distance known as the tracking radius of one another. Since the typical lateral separation between fingers is greater than the tracking radius for reasonable image scan rates touchdown and liftoff are easily detected by the fact that touchdown usually causes a new group to appear outside the tracking radii of existing paths, and liftoff will leave an active path without a group within its tracking radius. To prevent improper breaking of paths at high finger speeds each path's tracking radius P_{track} can be made dependent on its existing speed and proximity.

The first step 320 predicts the current locations of surface contacts along existing trajectories using path positions and velocities measured from previous images. Applying previous velocity to the location prediction improves the prediction except when a finger suddenly starts or stops or changes direction. Since such high acceleration events occur less often than zero acceleration events, the benefits of velocity-based prediction outweigh the potentially bad predictions during finger acceleration. Letting $P_x[n-1], P_y[n-1]$ be the position of path P from time step $n-1$ and $P_{vx}[n-1], P_{vy}[n-1]$ the last known velocity, the velocity-predicted path continuation is then:

$$P_{predx}[n] = P_x[n-1] + \Delta t P_{vx}[n-1] \quad (24)$$

$$P_{predy}[n] = P_y[n-1] + \Delta t P_{vy}[n-1] \quad (25)$$

Letting the set of paths active in the previous image be PA, and let the set electrode groups constructed in the current image be G, step 322 finds for each group Gk the closest active path and records the distance to it:

$$Gk_{closest} = \arg \min_{PA} d^2(Gk, PA) \quad (26)$$

$$Gk_{closest} P_{dist} = \min_{PA} d^2(Gk, PA) \quad (27)$$

where the squared Euclidean distance is an easily computed distance metric:

$$d^2(Gk, PA) = (Gk_x - P_{predx})^2 + (Gk_y - P_{predy})^2 \quad (28)$$

Step 324 then finds for each active path Pl, the closest active group and records the distance to it:

$$Pl_{closest} G = \arg \min_{Gk} d^2(Gk, Pl) \quad (29)$$

$$Pl_{closest} G_{dist} = \min_{Gk} d^2(Gk, Pl) \quad (30)$$

In step 326, an active group Gk and path Pl are only paired with one another if they are closest to one another, i.e., $Gk_{closest} = Pl$ and $Pl_{closest} = Gk$ refer to one another, and the distance

between them is less than the tracking radius. All of the following conditions must hold:

$$Gk_{closest} = Pl \quad (31)$$

$$Pl_{closest} = Gk \quad (32)$$

$$Pl_{closest} G_{dist} < Pl_{track} \quad (33)$$

To aid in detection of repetitive taps of the same finger, it may be useful to preserve continuity of path assignment between taps over the same location. This is accomplished in step Via USPTO EFS 334 by repeating steps 322-326 using only groups which were left unpaired above and paths which were deactivated within the last second or so due to finger liftoff.

In step 336, any group which has still not be paired with an active or recently deactivated path is allocated a new path, representing touchdown of a new finger onto the surface. In step 344, any active path which cannot be so paired with a group is deactivated, representing hand part liftoff from the surface.

Step 346 incorporates the extracted parameters of each group into its assigned path via standard filtering techniques. The equations shown below apply simple autoregressive filters to update the path position ($P_x[n], P_y[n], P_z[n]$), velocity ($P_{vx}[n], P_{vy}[n]$), and shape ($P_\theta[n], P_\epsilon[n]$) parameters from corresponding group parameters, but Kalman or finite impulse response filters would also be appropriate.

If a path P has just been started by group G at time step n, i.e., a hand part has just touched down, its parameters are initialized as follows:

$$P_x[n] = G_x \quad (34)$$

$$P_y[n] = G_y \quad (35)$$

$$P_z[n] = G_z \quad (36)$$

$$P_\theta[n] = G_\theta \quad (37)$$

$$P_\epsilon[n] = G_\epsilon \quad (38)$$

$$P_{vx}[n] = 0 \quad (39)$$

$$P_{vy}[n] = 0 \quad (40)$$

$$P_{vx}[n] = G_x / \Delta t \quad (41)$$

else if group G is a continuation of active path P[n-1] to time step n:

$$P_x[n] = G_\alpha G_x + (1 - G_\alpha) (P_{predx}[n-1]) \quad (42)$$

$$P_y[n] = G_\alpha G_y + (1 - G_\alpha) (P_{predy}[n-1]) \quad (43)$$

$$P_z[n] = G_\alpha G_z + (1 - G_\alpha) (P_{predz}[n-1]) \quad (44)$$

$$P_\theta[n] = G_\alpha G_\theta + (1 - G_\alpha) (P_\theta[n-1]) \quad (45)$$

$$P_\epsilon[n] = G_\alpha G_\epsilon + (1 - G_\alpha) (P_\epsilon[n-1]) \quad (46)$$

$$P_{vx}[n] = (P_x[n] - P_x[n-1]) / \Delta t \quad (47)$$

$$P_{vy}[n] = (P_y[n] - P_y[n-1]) / \Delta t \quad (48)$$

$$P_{vz}[n] = (P_z[n] - P_z[n-1]) / \Delta t \quad (49)$$

It is also useful to compute the magnitude P_{speed} and angle P_{dir} from the velocity vector (P_{vx}, P_{vy}). Since the reliability of position measurements increases considerably with total proximity P_z , the low-pass filter pole G_α is decreased for groups with total proximities lower than normal. Thus when

signals are weak, the system relies heavily on the previously established path velocity, but when the finger firmly touches the surface causing a strong, reliable signal, the system relies entirely on the current group centroid measurement.

The next process within the tracking module is contact identification. On surfaces large enough for multiple hands, the contacts of each hand tend to form a circular cluster, and the clusters tend to remain separate because users like to avoid entangling the fingers of opposite hands. Because the arrangement of fingers within a hand cluster is independent of the location of and arrangement within the other hand's cluster, the contact identification system is hierarchically split. The hand identification process 247 first decides to which cluster each contact belongs. Then a within-cluster identification process 248 analyzes for each hand the arrangement of contacts within the hand's cluster, independent of the other hand's cluster. Because within-cluster or finger identification works the same for each hand regardless of how many hands can fit on the surface, it will be described first. The description below is for identification within the right hand. Mirror symmetry must be applied to some parameters before identifying left hand contacts.

FIG. 23 shows the preferred embodiment of the finger identification process 248. For the contacts assigned to each hand this embodiment attempts to match contacts to a template of hand part attractor points, each attractor point having an identity which corresponds to a particular finger or palm heel. This matching between contact paths and attractors should be basically one to one but in the case that some hand parts are not touching the surface, some attractors will be left unfilled, i.e., assigned to the null path or dummy paths.

Step 350 initializes the locations of the attractor points to the approximate positions of the corresponding fingers and palms when the hand is in a neutral posture with fingers partially curled. Preferably these are the same default finger locations (F_{i_defx} , F_{i_defy}) employed in hand offset estimation. Setting the distances and angles between attractor points from a half-closed hand posture allows the matching algorithm to perform well for a wide variety of finger flexions and extensions.

The resulting attractor points tend to lie in a ring as displayed by the crosses in FIG. 24. The identities of attractor points 371-377 correspond to the identities of hand parts 201-207. If the given hand is a left hand, the attractor ring must be mirrored about the vertical axis from that shown. FIG. 24 also includes line segments 380 forming the Voronoi cell around each attractor point. Every point within an attractor's Voronoi cell is closer to that attractor than any other attractor. When there is only one contact in the cluster and its features are not distinguishing, the assignment algorithm effectively assigns the contact to the attractor point of the Voronoi cell which the contact lies within. When there are multiple surface contacts in a hand cluster, they could all lie in the same Voronoi cell, so the assignment algorithm must perform a global optimization which takes into account all of the contact positions at once.

Alternative embodiments can include additional attractors for other hand part or alternative attractor arrangements for atypical hand configurations. For example, attractors for forepalm contacts can be placed at the center of the ring, but since the forepalms typically do not touch the surface unless the rest of the hand is flattened onto the surface as well, forepalm attractors should be weighted such that contacts are assigned to them only when no regular attractors are left unassigned.

For optimal matching accuracy the ring should be kept roughly centered on the hand cluster. Therefore step 352 translates all of the attractor points for a given hand by the

hand's estimated position offset. The final attractor positions ($A_{j_x}[n]$, $A_{j_y}[n]$) are therefore given by:

$$A_{j_x}[n] = H_{max}[n] + F_{i_defx} \tag{50}$$

$$A_{j_y}[n] = H_{roy}[n] + F_{i_defy} \tag{51}$$

In alternative embodiments the attractor ring can also be rotated or scaled by estimates of hand rotation and size such as the estimated finger offsets, but care must be taken that wrong finger offset estimates and identification errors do not reinforce one another by severely warping the attractor ring.

Once the attractor template is in place, step 354 constructs a square matrix [d_{ij}] of the distances in the surface plane from each active contact path P_i to each attractor point A_j . If there are fewer surface contacts than attractors, the null path P_0 , which has zero distance to each attractor, takes place of the missing contacts. Though any distance metric can be used, the squared Euclidean distance,

$$d_{ij} = (A_{j_x}[n] - P_{i_x}[n])^2 + (A_{j_y}[n] - P_{i_y}[n])^2 \tag{52}$$

is preferred because it specially favors assignments wherein the angle between any pair of contacts is close to the angle between the pair of attractors assigned to those contacts. This corresponds to the biomechanical constraint that fingertips avoid crossing over one another, especially while touching a surface.

In step 356, the distances from each contact to selected attractors are weighted according to whether the geometrical features of the given contact match those expected from the hand part that the attractor represents. Since the thumb and palm heels exhibit the most distinguishing geometrical features, weighting functions are computed for the thumb and palm heel attractors, and distances to fingertip attractors are unchanged. In a preferred embodiment, each weighting function is composed of several factor versus feature relationships such as those plotted approximately in FIG. 25. Each factor is designed to take on a default value of 1 when its feature measurement provides no distinguishing information, take on larger values if the measured contact feature uniquely resembles the given thumb or palm hand part, and take on smaller values if the measured feature is inconsistent with the given attractor's hand part. The factor relationships can be variously stored and computed as lookup tables, piecewise linear functions, polynomials, trigonometric functions, rational functions, or any combination of these. Since assignment between a contact and an attractor whose features match is favored as the weighted distance between becomes smaller, the distances are actually weighted (multiplied) with the reciprocals of the factor relationships shown.

FIG. 25A shows the right thumb and right inner palm heel orientation factor versus orientation of a contact's fitted ellipse. Orientation of these hand parts tends to be about 120°, whereas fingertip and outer palm heel contacts are usually very close to vertical (90°), and orientation of the left thumb and left inner palm heel averages 60°. The right orientation factor therefore approaches a maximum at 120°. It approaches the default value of 1 at 0°, 90°, and 180° where orientation is inconclusive of identity, and reaches a minimum at 60°, the favored orientation of the opposite thumb or palm heel. The corresponding relationship for the left thumb and inner palm heel orientation factor is flipped about 90°.

FIG. 25B approximately plots the thumb size factor. Since thumb size as indicated by total proximity tends to peak at two or three times the size of the typical curled fingertip, the thumb size factor peaks at these sizes. Unlike palm heels, thumb contacts can not be much larger than two or three times the default fingertip size, so the thumb factor drops back down

for larger sizes. Since any hand part can appear small when touching the surface very lightly or just starting to touch-down, small size is not distinguishing, so the size factor defaults to 1 for very small contacts.

FIG. 25C approximately plots the palm heel size factor. As more pressure is applied to the palms, the palm heel contacts can grow quite large, remaining fairly round as they do so. Thus the palm heel size factor is much like the thumb size factor except the palm factor is free to increase indefinitely. However, fingertip contacts can grow by becoming taller as the fingers are flattened. But since finger width is constant, the eccentricity of an ellipse fitted to a growing fingertip contact increases in proportion to the height. To prevent flattened fingers from having a large palm factor, has little effect for palms, whose eccentricity remains near 1, but cancels the high proximities of flattened fingertips. Though directly using fitted ellipse width would be less accurate for low resolution electrode arrays, the above ratio basically captures contact width.

Another important distinguishing feature of the palm heels is that wrist anatomy keeps the centroids of their contacts separated from one other and from the fingers by several centimeters. This is not true of the thumb and fingertips, which can be moved within a centimeter of one another via flexible joints. The inter-palm separation feature is measured by searching for the nearest neighbor contact of a given contact and measuring the distance to the neighbor. As plotted approximately in FIG. 25D, the palm separation factor quickly decreases as the separation between the contact and its nearest neighbor falls below a few centimeters, indicating that the given contact (and its nearest neighbor) are not palm heels. Unlike the size and orientation factors which only become reliable as the weight of the hands fully compresses the palms, the palm separation factor is especially helpful in distinguishing the palm heels from pairs of adjacent fingertips because it applies equally well to light, small contacts.

Once the thumb and palm weightings have been applied to the distance matrix, step 358 finds the one-to-one assignment between attractors and contacts which minimizes the sum of weighted distances between each attractor and its assigned contact. For notational purposes, let a new matrix $[c_{ij}]$ hold the weighted distances:

$$c_{ij} = \begin{cases} d_{ij} / (P_{thumb_size_fact} P_{orient_fact}) & \text{if } j = 1 \\ d_{ij} & \text{if } 2 \leq j \leq 5 \\ d_{ij} / (P_{palm_size_fact} P_{palm_sep_fact}) & \text{if } j = 6 \\ d_{ij} / (P_{palm_size_fact} P_{palm_sep_fact}) & \text{if } j = 7 \end{cases} \quad (53)$$

Mathematically the optimization can then be stated as finding the permutation $\{\pi_1, \dots, \pi_7\}$ of integer hand part identities $\{1, \dots, 7\}$ which minimizes:

$$\sum_{i=1}^7 c_{i\pi_i} \quad (54)$$

where c_{ij} is the weighted distance from contact i to attractor j , and contact i and attractor j are considered assigned to one another when $\pi_i=j$. This combinatorial optimization problem, known more specifically in mathematics as an assignment problem, can be efficiently solved by a variety of well-known mathematical techniques, such as branch and bound, local-

ized combinatorial search, the Hungarian method, or network flow solvers. Those skilled in the art will recognize that this type of combinatorial optimization problem has a mathematically equivalent dual representation in which the optimization is reformulated as a maximization of a sum of dual parameters. Such reformulation of the above hand part identification method as the dual of attractor-contact distance minimization remains well within the scope of this invention.

To avoid unnecessary computation, decision diamond 360 ends the finger identification process at this stage if the hand assignment of the given contact cluster is only a tentative hypothesis being evaluated by the hand identification module 247. However, if the given hand assignments are the final preferred hypothesis, further processes verify finger identities and compile identity statistics such as finger counts.

The identifications produced by this attractor assignment method are highly reliable when all five fingers are touching the surface or when thumb and palm features are unambiguous. Checking that the horizontal coordinates for identified fingertip contacts are in increasing order easily verifies that fingertip identities are not erroneously swapped. However, when-only two to four fingers are touching, yet no finger strongly exhibits thumb size or orientation features, the assignment of the innermost finger contact may wrongly indicate whether the contact is the thumb. In this case, decision diamond 362 employs a thumb verification process 368 to take further measurements between the innermost finger contact and the other fingers. If these further measurements strongly suggest the innermost finger contact identity is wrong, the thumb verification process changes the assignment of the innermost finger contact. Once the finger assignments are verified, step 364 compiles statistics about the assignments within each hand such as the number of touching fingertips and bitfields of touching finger identities. These statistics provide convenient summaries of identification results for other modules.

FIG. 26 shows the steps within the thumb verification module. The first 400 is to compute several velocity, separation, and angle factors for the innermost contact identified as a finger relative to the other contacts identified as fingers. Since these inter-path measurements presuppose a contact identity ordering, they could not have easily been included as attractor distance weightings because contact identities are not known until the attractor distance minimization is complete. For the factor descriptions below, let FI be the innermost finger contact, FN be the next innermost finger contact, FO be the outermost finger contact.

The separation between thumb and index finger is often larger than the separations between fingertips, but all separations tend to grow as the fingers are outstretched. Therefore an inner separation factor $inner_separation_fact$ is defined as the ratio of the distance between the innermost and next innermost finger contacts to the average of the distances between other adjacent fingertip contacts, $avg_separation$: $innerseparationfact \min$

$$innerseparationfact \approx \min \left(1, \frac{\sqrt{(FI_x - FN_x)^2 + (FI_y - FN_y)^2}}{avgseparation} \right) \quad (55)$$

The factor is clipped to be greater than one since an innermost separation less than the average can occur regardless of whether thumb or index finger is the innermost touching finger. In case there are only two finger contacts, a default average separation of 2-3 cm is used. The factor tends to

become larger than one if the innermost contact is actually the thumb but remains near one if the innermost contact is a fingertip.

Since the thumb rarely moves further forward than the fingertips except when the fingers are curled into a fist, the angle between the innermost and next innermost finger contact can help indicate whether the innermost finger contact is the thumb. For the right hand the angle of the vector from the thumb to the index finger is most often 60°, though it ranges to 0 as the thumb moves forward and to 120° as the thumb adducts under the palm. This is reflected in the approximate plot of the inner angle factor in FIG. 32, which peaks at 60° and approaches 0 toward 0° and 120°. If the innermost finger contact is actually an index fingertip, the measured angle between innermost and next innermost contact will likely be between 30° and -60°, producing a very small angle factor.

The inner separation and angle factors are highly discriminating of neutral thumb postures, but users often exceed the above cited separation and angle ranges when performing hand scaling or rotation gestures. For instance, during an anti-pinch gesture, the thumb may start pinched against the index or middle fingertip, but then the thumb and fingertip slide away from one another. This causes the inner separation factor to be relatively small at the start of the gesture. Similarly, the thumb-index angle can also exceed the range expected by the inner angle factor at the beginning or end of hand rotation gestures, wherein the fingers rotate as if turning a screw. To compensate, the inner separation and angle factors are fuzzy OR'ed with expansion and rotation factors which are selective for symmetric finger scalings or rotations centered on a point between the thumb and fingertips.

When defined by the following approximate equation, the expansion factor peaks as the innermost and outermost finger contacts slide at approximately the same speed and in opposite directions, parallel to the vector between them:

$$\text{expansion_fact} = \frac{\sqrt{F_{I_speed}[n]} \times F_{O_speed}[n] \times \cos(F_{I_dir}[n] - \angle(FI[n], FO[n]))}{\cos(F_{O_dir}[n] - \angle(FI[n], FO[n]))} \quad (56)$$

$$\text{expansion_fact} = \max(0, \text{expansion_fact}) \quad (57)$$

where $\angle(FI[n], FO[n])$ is the angle between the fingers:

$$\angle(FI[n], FO[n]) = \arctan\left(\frac{F_{I_y}[n] - F_{O_y}[n]}{F_{I_x}[n] - F_{O_x}[n]}\right) \quad (58)$$

Translational motions of both fingers in the same direction produce negative factor values which are clipped to zero by the max operation. Computing the geometric rather than arithmetic mean of the innermost and outermost speeds aids selectivity by producing a large expansion factor only when speeds of both contacts are high.

The rotation factor must also be very selective. If the rotation factor was simply proportional to changes in the angle between innermost and outermost finger, it would erroneously grow in response to asymmetries in finger motion such as when the innermost finger starts translating downward while the outermost contact is stationary. To be more selective, the rotation factor must favor symmetric rotation about an imaginary pivot between the thumb and fingertips. The approximate rotation factor equation below peaks as the innermost and outermost finger move in opposite directions, but in this case the contacts should move perpendicular to the vector between them:

$$\text{rotation_fact} = \frac{\sqrt{F_{I_speed}[n]} \times F_{O_speed}[n] \times \sin(F_{I_dir}[n] - \angle(FI[n], FO[n]))}{\sin(F_{O_dir}[n] - \angle(FI[n], FO[n]))} \quad (59)$$

$$\text{rotation_fact} = \max(0, \text{rotation_fact}) \quad (60)$$

Since motions which maximize this rotation factor are easy to perform between the opposable thumb and another finger but difficult to perform between two fingertips the rotation factor is a robust indicator of thumb presence.

Finally, a fuzzy logic expression (step 402) combines these inter-contact factors with the thumb feature factors for the innermost and next innermost finger contacts. In a preferred embodiment, this fuzzy logic expression for the combined_thumb_fact takes the form:

$$\text{combined_thumb_fact} = (\text{inner_separation_fact} \times \text{angle_fact} + \text{expansion_fact} + \text{rotation_fact}) \times (F_{I_orient_fac} / F_{N_thumb_use_fac} / F_{N_thumb_use_fac}) \quad (61)$$

The feature factor ratios of this expression attempt to compare the features of the innermost contact to current features of the next innermost contact, which is already known to be a fingertip. If the innermost contact is also a fingertip its features should be similar to the next innermost, causing the ratios to remain near one. However, thumb-like features on the innermost contact will cause the ratios to be large. Therefore if the combined thumb factor exceeds a high threshold, diamond 404 decides the innermost finger contact is definitely a thumb. If decision diamond 412 determines the contact is not already assigned to the thumb attractor 412, step 414 shifts the contact assignment inward on the attractor ring to the thumb attractor. Otherwise, if decision diamond 406 determines that the combined thumb factor is less than a low threshold, the innermost contact is most definitely not the thumb. Therefore if decision diamond 408 finds the contact assigned to the thumb attractor, step 410 shifts the innermost contact assignment and any adjacent finger contacts outward on the attractor ring to unfill the thumb attractor. If the combined_thumb_fact is between the high and low threshold or if the existing assignments agree with the threshold decisions, step 413 makes no assignment changes.

The hand contact features and interrelationships introduced here to aid identification can be measured and combined in various alternative ways yet remain well within the scope of the invention. In alternative embodiments of the multi-touch surface apparatus which include raised, touch-sensitive palm rests, palm identification and its requisite attractors and factors may be eliminated. Geometrical parameters can be optimally adapted to measurements of individual user hand size taken while the hand is flattened. However, the attractor-based identification method already tolerates variations in a single person's finger positions due to finger flexion and extension which are as great or greater than the variations in hand size across adult persons. Therefore adaptation of the thumb and palm size factors to a person's average finger and palm heel proximities is more important than adaptation of attractor positions to individual finger lengths, which will only add marginal performance improvements.

As another example of an alternative method for incorporating these features and relationships into a hand contact identifier, FIG. 27 diagrams an alternative finger identification embodiment which does not include an attractor template. To order the paths from finger and palm contacts within a given hand 430, step 432 constructs a two-dimensional matrix of the distances from each contact to the other contacts. In step 434, a shortest path algorithm well known from the theory of network flow optimization then finds the shortest graph cycle connecting all the contact paths and passing

through each once 434. Since hand contacts tend to lie in a ring this shortest graph cycle will tend to connect adjacent contacts, thus establishing a sensible ordering for them.

The next step 438 is to pick a contact at an extreme position in the ring such as the innermost or outermost and test whether it is a thumb (decision diamond 440) or palm (decision diamond 442). This can be done using contact features and fuzzy logic expressions analogous to those utilized in the thumb verification process and the attractor weightings. If the innermost path is a thumb, step 444 concludes that contacts above are most likely fingertips, and contacts in the ring below the thumb are most likely palms. If (442) the innermost path is a palm heel, step 446 concludes the paths significantly above the innermost must be fingers while paths at the same vertical level should be palms. The thumb and palm tests are then repeated for the contacts adjacent in the ring to the innermost until any other thumb or palm contacts are found. Once any thumb and palm contacts are identified, step 448 identifies remaining fingertip contacts by their respective ordering in the ring and their relatively high vertical position.

Since this alternative algorithm does not include an attractor template to impose constraints on relative positions, the fuzzy verification functions for each contact may need to include measurements of the vertical position of the contact relative to other contacts in the ring and relative to the estimated hand offset. The attractor template embodiment is preferred over this alternative embodiment because the attractor embodiment more elegantly incorporates expected angles between contacts and the estimated hand offset into the finger identification process.

Hand identification is needed for multi-touch surfaces which are large enough to accommodate both hands simultaneously and which have the left and right halves of the surface joined such that a hand can roam freely across the middle to either half of the surface. The simplest method of hand identification would be to assign hand identity to each contact according to whether the contact initially touched down in the left or right half of the surface. However, if a hand touched down in the middle, straddling the left and right halves, some of the hand's contacts would end up assigned to the left hand and others to the right hand. Therefore more sophisticated methods which take into account the clustering properties of hand contacts must be applied to ensure all contacts from the same hand get the same identity. Once all surface contacts are initially identified, the path tracking module can reliably retain existing identifications as a hand slides from one side of the surface to the other.

The thumb and inner palm contact orientations and the relative thumb placement are the only contact features independent of cluster position which distinguish a lone cluster of right hand contacts from a cluster of left hand contacts. If the thumb is lifted off the surface, a right hand contact cluster appears nearly indistinguishable from a left hand cluster. In this case cluster identification must still depend heavily on which side of the board the cluster starts on, but the identity of contacts which recently lifted off nearby also proves helpful. For example, if the right hand moves from the right side to the middle of the surface and lifts off, the next contacts which appear in the middle will most likely be from the right hand touching back down, not from the left hand moving to the middle and displacing the right hand. The division between left and right halves of the surface should therefore be dynamic, shifting toward the right or left according to which hand was most recently near the middle. Since the hand offset estimates temporarily retain the last known hand positions

after liftoff, such a dynamic division is implemented by tying the positions of left hand and right hand attractor templates to the estimated hand positions.

Though cases remain in which the user can fool the hand identification system with sudden placements of a hand in unexpected locations, the user may actually wish to fool the system in these cases. For example, users with only one hand free to use the surface may intentionally place the hand far onto the opposite half of the surface to access the chord input operations of the opposite hand. Therefore, when a hand cluster suddenly touches down well into the opposite half of the surface, it can safely be given the opposite halves identity, regardless of its true identity. Arching the surface across the middle can also discourage users from sliding a hand to the opposite side by causing awkward forearm pronation should users do so.

FIG. 29 shows process details within the hand identification module 247. Decision diamond 450 first determines whether the hand identification algorithm actually needs to be executed by checking whether all path proximities have stabilized. To maximize stability of the identifications, hand and finger identities need only be reevaluated when a new hand part touches down or disambiguating features of existing contacts become stronger. The contact size and orientation features are unreliable until the flesh fully compresses against the surface a few dozen milliseconds after initial surface contact. Therefore decision diamond 450 executes the hand identification algorithm for each proximity image in which a new contact appears and for subsequent proximity images in which the total proximity of any new contacts continues to increase. For images in which proximities of existing contacts have stabilized and no new contacts appear, path continuation as performed by the path tracking process 245 is sufficient to retain and extend (step 452) the contact identifications computed from previous images.

Should the hand identification algorithm be invoked for the current image, the first step 453 is to define and position left and right hand attractor templates. These should be basically the same as the attractor templates (FIG. 24, step 352) used in within-hand identification, except that both left and right rings must now be utilized at once. The default placement of the rings relative to one another should correspond to the default left and right hand contact positions shown in FIG. 20A. Each ring translates to follow the estimated position of its hand, just like the sloppy segmentation regions follow the hands in FIG. 20B. Individual attractor points can safely be translated by their corresponding estimated finger offsets. Therefore the final attractor positions ($A_{j,x}[n], A_{j,y}[n]$) for the left hand L and right hand H attractor rings are:

$$L_{A_{j,x}}[n] = Lh_{\text{ext}}[n] + LF_{\text{ext}}[n] + Lf_{\text{def}} \tag{62}$$

$$L_{A_{j,y}}[n] = Lh_{\text{ext}}[n] + LF_{\text{ext}}[n] + Lf_{\text{def}} \tag{63}$$

$$R_{A_{j,x}}[n] = Rh_{\text{ext}}[n] + RF_{\text{ext}}[n] + Rf_{\text{def}} \tag{64}$$

$$R_{A_{j,y}}[n] = Rh_{\text{ext}}[n] + RF_{\text{ext}}[n] + Rf_{\text{def}} \tag{65}$$

Basically the hand identification algorithm will compare the cost of assigning contacts to attractors in one ring versus the other, the cost depending on the sum of weighted distances between each contact and its assigned attractor. Adjusting the attractor ring with the estimated hand and finger offsets lowers the relative costs for assignment hypotheses which resemble recent hand assignments, helping to stabilize identifications across successive proximity images even when hands temporarily lift off.

Next a set of assignment hypotheses must be generated and compared. The most efficient way to generate sensible

US 7,812,828 B2

37

hypotheses is to define a set of roughly vertical contour lines, one between each horizontally adjacent contact. Step 454 does this by ordering all surface contacts by their horizontal coordinates and establishing a vertical contour halfway between each pair of adjacent horizontal coordinates. FIGS. 30A-C show examples of three different contours 475 and their associated assignment hypotheses for a fixed set of contacts. Each contour corresponds to a separate hypothesis, known also as a partition, in which all contacts to the left 476 of the contour are from the left hand, and all contacts to the right 477 of the contour are from the right hand. Contours are also necessary at the left and right ends of the surface to handle the hypotheses that all contacts on the surface are from the same hand. Contours which hypothesize more contacts on a given hand than can be caused by a single hand are immediately eliminated.

Generating partitions via vertical contours avoids all hypotheses in which contacts of one hand horizontally overlap or cross over contacts of the opposite hand. Considering that each hand can cause seven or more distinct contacts, this reduces the number of hand identity permutations to examine from thousands to at most a dozen. With fewer hypotheses to examine, the evaluation of each partition can be much more sophisticated, and if necessary, computationally costly.

The optimization search loop follows. Its goal is to determine which of the contours divides the contacts into a partition of two contact clusters such that the cluster positions and arrangement of contacts within each cluster best satisfy known anatomical and biomechanical constraints. The optimization begins by picking (step 456) a first contour divider such as the leftmost and tentatively assigning (step 458) any contacts to the left of the contour to the left hand and the rest to the right hand. Step 460 invokes the finger identification algorithm of FIG. 23, which attempts to assign finger and palm identities to contacts within each hand. Decision diamond 360 avoids the computational expense of thumb verification 368 and statistics gathering 364 for this tentative assignment hypothesis.

Returning to FIG. 29, step 462 computes a cost for the partition. This cost is meant to evaluate how well the tentatively identified contacts fit their assigned attractor ring and how well the partition meets between-hand separation constraints. This is done by computing for each hand the sum of weighted distances from each tentatively identified contact to its assigned attractor point as in Equation 54 of finger identification, including size and orientation feature factors for thumb and palm attractors. This sum represents the basic template fitting cost for a hand. Each hand cost is then weighted as a whole with the reciprocals of its clutching velocity, handedness, and palm cohesion factors. These factors, to be described below, represent additional constraints which are underemphasized by the weighted attractor distances. Finally, the weighted left and right hand costs are added together and scaled by the reciprocal of a hand separation factor to obtain a total cost for the partition.

If decision diamond 464 determines this total cost is lower than the total costs of the partitions evaluated so far 464, step 466 records the partition cost as the lowest and records the dividing contour. Decision diamond 472 repeats this process for each contour 470 until the costs of all partitions have been evaluated. Step 473 chooses the partition which has the lowest cost overall as the actual hand partitioning 473, and the hand identities of all contact paths are updated accordingly. Then step 474 reinvokes the within-hand finger contact identification process so that the thumb verification and statistics gathering processes are performed using the actual hand assignments.

38

Users often perform clutching motions in which the right hand, for example, lifts off from a slide at the right side of the surface, touches backdown in the middle of the surface, and resumes sliding toward the right. Therefore when a hand is detected touching down in the middle of the surface and sliding toward one side, it probably came from the other side. A hand velocity factor, plotted approximately in FIG. 31A, captures this phenomenon by slightly increasing in value when a hand cluster's contacts are moving toward the cluster's assigned side of the board, thus decreasing the basic cost of the hand. The factor is a function of the average of the contacts' horizontal velocities the side of the surface the given cluster is assigned. Since high speeds do not necessarily give a stronger indication of user intent the factor saturates at moderate speeds.

Though the thumb orientation factors help identify which hand a thumb is from when the thumb lies in the ambiguous middle region of the surface, the vertical position of the thumb relative to other fingers in the same hand also gives a strong indication of handedness. The thumb tends to be positioned much lower than the fingertips, but the pinky tends to be only slightly lower than the other fingertips. The handedness factor plotted approximately in FIG. 31B, takes advantage of this constraint by boosting the hand cost when the contact identified as the outermost fingertip is more than a couple centimeters lower than the next outermost fingertip contact. In such cases the tentative hand assignment for all contacts in the cluster is probably wrong. Since this causes the within-hand identification algorithm to fit the contacts to the wrong attractor ring, finger identities become reversed such that the supposedly lowered pinky is truly a lowered thumb of the opposite hand. Unfortunately, limited confidence can be placed in the handedness factor. Though the pinky should not appear lowered as much as the thumb the outer palm heel can, creating an ambiguity in which the thumb and fingertips of one hand have the same contact arrangement as the fingertips and outer palm heel of the opposite hand. This ambiguity can cause the handedness factor to be erroneously low for an accurately identified hand cluster, so the handedness factor is only used on clusters in the middle of the surface where hand position is ambiguous.

Distinguishing contact clusters is challenging because a cluster can become quite sparse and large when the fingers are outstretched, with the pinky and thumb of the same hand spanning up to 20 cm. However, the palm can stretch very little in comparison, placing useful constraints on how far apart palm heel contacts and forepalms from the same hand can be. The entire palm region of an outstretched adult hand is about 10 cm square, so palm contact centroids should not be scattered over a region larger than about 8 cm. When a partition wrongly includes fingers from the opposite hand in a cluster, the within-cluster identification algorithm tends to assign the extra fingers from the opposite hand to palm heel and forepalm attractors. This usually causes the contacts assigned to the cluster's palm attractors to be scattered across the surface wider than is plausible for true palm contacts from a single hand. To punish such partitions, the palm cohesion factor quickly drops below one for a tentative hand cluster in which the supposed palm contacts are scattered over a region larger than 8 cm. Therefore its reciprocal will greatly increase the hand's basic cost. FIG. 31C shows the value of the palm cohesion factor versus horizontal separation between palm contacts. The horizontal spread can be efficiently measured by finding the maximum and minimum horizontal coordinates of all contacts identified as palm heels or forepalms and taking the difference between the maximum and minimum. The measurement and factor value lookup are repeated for the

US 7,812,828 B2

39

vertical separation, and the horizontal and vertical factors are multiplicatively combined to obtain the final palm cohesion factor.

FIG. 33 is an approximate plot of the inter-hand separation factor. This factor increases the total costs of partitions in which the estimated or actual horizontal positions of the thumbs from each hand approach or overlap. It is measured by finding the minimum of the horizontal offsets of right hand contacts with respect to their corresponding default finger positions. Similarly the maximum of the horizontal offsets of the left hand contacts with respect to their corresponding default finger positions is found. If the difference between these hand offset extremes is small enough to suggest the thumbs are overlapping the same columnar region of the surface while either touching the surface or floating above it, the separation factor becomes very small. Such overlap corresponds to a negative thumb separation in the plot. To encourage assignment of contacts which are within a couple centimeters of one another to the same cluster, the separation factor gradually begins to drop starting with positive separations of a few centimeters or less. The inter-hand separation factor is not applicable to partitions in which all surface contacts are assigned to the same hand, and takes on the default value of one in this case.

Alternative embodiments of this hand identification process can include additional constraint factors and remain well within the scope of this invention. For example, a velocity coherence factor could be computed to favor partitions in which all fingers within a cluster slide at approximately the same speed and direction, though each cluster as a whole has a different average speed and direction.

Sometimes irreversible decisions made by the chord motion recognizer or typing recognized on the basis of existing hand identifications prevent late changes in the identifications of hand contacts even when new proximity image information suggests existing identifications are wrong. This might be the case for a chord slide which generates input events that can not be undone, yet well into the slide new image information indicates some fingers in the chord should have been attributed to the opposite hand. In this case the user can be warned to stop the slide and check for possible input errors but in the meantime it is best to retain the existing identifications even if wrong, rather than switch to correct assignments which could have further unpredictable effects when added to the erroneous input events. Therefore once a chord slide has generated input events, the identifications of their existing paths may be locked so the hand identification algorithm can only swap identifications of subsequent new contacts.

This hand identification process can be modified for differently configured multi-touch surfaces and remain well within the scope of this invention. For surfaces which are so narrow that thumbs invade one another's space or so tall that one hand can lie above another, the contours need not be straight vertical lines. Additional contours could weave around candidate overlapping thumbs, or they could be perpendicular to the vector between the estimated hand positions. If the surface was large enough for more than one user, additional attractor rings would have to be provided for each additional hand, and multiple partitioning contours would be necessary per hypothesis to partition the surface into more than two portions. On a surface large enough for only one hand it might still be necessary to determine which hand was touching the surface. Then instead of hypothesizing different contours, the hand identification module would evaluate the hypotheses that either the left hand attractor ring or the right hand attractor ring was centered on the surface. If the surface

40

was mounted on a pedestal to allow access from all sides, the hand identification module would also hypothesize various rotations of each attractor ring.

The attractor-based finger identification system 248 will successfully identify the individual hand contacts which comprise the pen grip hand configuration (FIG. 15). However, additional steps are needed to distinguish the unique finger arrangement within the pen grip from the normal arrangement within the closed hand configuration (FIG. 14). In this pen grip arrangement the outer fingers curl under toward the palms so their knuckles touch the surface and the index, finger juts out ahead of them. The pen grip detection module 17 employs a fuzzy pattern recognition process similar to the thumb verification process to detect this unique arrangement

An additional problem with handwriting recognition via the pen grip hand configuration is that the inner gripping fingers and sometimes the whole hand will be picked up between strokes, causing the distinguishing finger arrangement to temporarily disappear. Therefore the pen grip recognition process must have hysteresis to stay in handwriting mode between gripping finger lifts. In the preferred embodiment, hysteresis is obtained by temporal filtering of the combined fuzzy decision factors and by using the estimated finger positions in measurements of finger arrangement while the actual fingers are lifted off the surface. The estimated finger positions provide effective hysteresis because they temporarily retain the unique jutting arrangement before decaying back toward the normal arched fingertip positions a few seconds after liftoff.

FIG. 28 shows the steps within the pen grip detection module 17. Decision diamond 485 determines whether all pen grip hand parts are touching the surface. If not decision diamond 486 causes the estimated finger and palm positions to be retrieved for any lifted parts in step 487 only if pen grip or handwriting mode is already active. Otherwise the process exits for lack of enough surface contacts. Thus the estimated finger positions cannot be used to start handwriting mode, but they can continue it. Step 488 retrieves the measured positions and sizes of fingers and palm heels which are touching the surface.

Step 489 computes a knuckle factor from the outer finger sizes and their vertical distance from the palm heels which peaks as the outer finger contacts become larger than normal fingertips and close to the palm heels. Step 490 computes a jutting factor from the difference between the vertical coordinates of the inner and outer fingers which peaks as the index fingertip juts further out in front of the knuckles. Step 491 combines the knuckle and jutting factors in a fuzzy logic expression and averages the result with previous results via an autoregressive or moving average filter. Decision diamond 492 continues or starts pen grip mode if the filtered expression result is above a threshold which may itself be variable to provide additional hysteresis. While in pen grip mode, typing 12 and chord motion recognition 18 are disabled for the pen gripping hand.

In pen grip mode, decision diamond 493 determines whether the inner gripping fingers are actually touching the surface. If so, step 495 generates inking events from the path parameters of the inner fingers and appends them to the outgoing event queue of the host communication interface. These inking events can either cause "digital ink" to be laid on the display 24 for drawing or signature capture purposes, or they can be intercepted by a handwriting recognition system and interpreted as gestures or language symbols. Handwriting recognition systems are well known in the art.

US 7,812,828 B2

41

If the inner fingers are lifted, step 494 sends stylus raised events to the host communication interface to instruct the handwriting recognition system of a break between symbols. In some applications the user may need to indicate where the "digital ink" or interpreted symbols are to be inserted on the display by positioning a cursor. Though on a multi-touch surface a user could move the cursor by leaving the pen grip configuration and sliding a finger chord, it is preferable to allow cursor positioning without leaving the pen grip configuration. This can be supported by generating cursor positioning events from slides of the palm heels and outer knuckles. Since normal writing motions will also include slides of the palm heels and outer knuckles, palm motions should be ignored until the inner fingers have been lifted for a few hundred milliseconds.

Should the user actually pick up a conductive stylus and attempt to write with it, the hand configuration will change slightly because the inner gripping fingers will be directing the stylus from above the surface rather than touching the surface during strokes. Since the forearm tends to supinate more when actually holding a stylus, the inner palm heel may also stay off the surface while the hand rests on the sides of the pinky, ring finger and the outer palm heel. Though the outer palm heel may lie further outward than normal with respect to the pinky, the ring and pinky fingers will still appear as large knuckle contacts curled close to the outer palm. The tip of the stylus essentially takes the place of the index fingertip for identification purposes, remaining at or above the vertical level of the knuckles. Thus the pen grip detector can function in essentially the same way when the user writes with a stylus, except that the index fingertip path sent to the host communication interface will in actuality be caused by the stylus.

Technically, each hand has 24 degrees of freedom of movement in all finger joints combined, but as a practical matter, tendon linkage limitations make it difficult to move all of the joints independently. Measurements of finger contacts on a surface yield ten degrees of freedom in motion lateral to the surface, five degrees of freedom in individual fingertip pressure or proximity to the surface, and one degree of freedom of thumb orientation. However, many of these degrees of freedom have limited ranges and would require unreasonable twisting and dexterity from the average user to access independently.

The purpose of the motion component extraction module 16 is to extract from the 16 observable degrees of freedom enough degrees of freedom for common graphical manipulation tasks in two and three dimensions. In two dimensions the most common tasks are horizontal and vertical panning, rotating, and zooming or resizing. In three dimensions, two additional rotational degrees of freedom are available around the horizontal and vertical axes. The motion component extractor attempts to extract these 4-6 degrees of freedom from those basic hand motions which can be performed easily and at the same time without interfering with one another. When multiple degrees of freedom can be accessed at the same time they are said to be integral rather than separable, and integral input devices are usually faster because they allow diagonal motions rather than restricting motions to be along a single axis or degree of freedom at one time.

When only four degrees of freedom are needed, the basic motions can be whole hand translation, hand scaling by uniformly flexing or extending the fingers, and hand rotation either about the wrist as when unscrewing a jar lid or between the fingers as when unscrewing a nut. Not only are these hand motions easy to perform because they utilize motions which intuitively include the opposable thumb, they correspond cognitively to the graphical manipulation tasks of object rota-

42

tion and sizing. Their only drawback is that the translational motions of all the fingers during these hand rotations and scalings do not cancel perfectly and can instead add up to a net translation in some direction in addition to the desired rotation or scaling. To allow all motions to be performed simultaneously so that the degrees of freedom are integral yet to prevent unintended translations from imperfectly performed scalings and rotations, the motion extractor preferentially weights the fingers whose translations cancel best and non-linearly scales velocity components depending on their speeds relative to one another.

The processes within the motion component extractor 16 are shown in FIG. 34. Step 500 first fetches the identified contact paths 250 for the given hand. These paths contain the lateral velocities and proximities to be used in the motion calculations, and the identifications are needed so that motion of certain fingers or palm heels which would degrade particular motion component calculations can be deemphasized.

The next step 502 applies additional filtering to the lateral contact velocities when finger proximity is changing rapidly. This is necessary because during finger liftoff and touch down on the surface, the front part of the fingertip often touches down before and lifts off after the back of the fingertip, causing a net downward or upward lateral translation in the finger centroid. Such proximity-dependent translations can be put to good use when slowly rolling the fingertip for fine positioning control, but they can also annoy the user if they cause the cursor to jump away from a selected position during finger liftoff. This is prevented by temporarily downscaling a finger's lateral velocity in proportion to large changes in the finger's proximity. Since other fingers within a hand tend to shift slightly as one finger lifts off, additional downscaling of each finger velocity is done in response to the maximum percent change in proximity among contacting fingers. Alternatively, more precise suppression can be obtained by subtracting from the lateral finger speed an amount proportional to the instantaneous change in finger contact height. This assumes that the perturbation in lateral finger velocity caused by finger liftoff is proportional to the change in contact height due to the back of the fingertip lifting off first or touching down last.

Process 504, whose detailed steps are shown in FIG. 36, measures the polar velocity components from radial (scaling) and rotational motion. Unless rotation is extracted from thumb orientation changes, at least two contacting fingers are necessary to compute a radial or angular velocity of the hand. Since thumb motion is much more independent of the other fingers than they are of one another, scalings and rotations are easier for the user to perform if one of these fingers is the opposable thumb, but the measurement method will work without the thumb. If decision diamond 522 determines that less than two fingers are touching the surface, step 524 sets the radial and rotational velocities of the hand to zero. FIG. 35 shows trajectories of each finger during a contractive hand scaling. The thumb 201 and pinky 205 travel in nearly opposite directions at roughly the same speed, so that the sum of their motions cancels for zero net translation, but the difference in their motions is maximized for a large net scaling. The central fingers 202-204 also move toward a central point but the palm heels remain stationary, failing to complement the flexing of the central fingers. Therefore the difference between motion of a central finger and any other finger is usually less than the difference between the pinky and thumb motions, and the sum of central finger velocities during a hand scaling adds up to a net vertical translation. Similar phenomena occur during hand rotations, except that if the rotation is centered at the wrist with forearm fixed rather than

centered at the forepalms, a net horizontal translation will appear in the sum of motions from any combination of fingers.

Since the differences in finger motion are usually greatest between thumb and pinky, step 526 only retrieves the current and previous positions of the innermost and outermost touching fingers for the hand scaling and rotation measurements.

Step 528 then computes the hand scaling velocity H_{vs} from the change in distance between the innermost finger FI and outermost finger FO with approximately the following equation:

$$H_{vs}[n] = \frac{d(FI[n], FO[n]) - d(FI[n-1], FO[n-1])}{\Delta t} \quad (66)$$

where $d(FI[n], FO[n])$ is the squared Euclidean distance between the fingers:

$$d(FI[n], FO[n]) = \sqrt{(F_{Ix}[n] - F_{Ox}[n])^2 + (F_{Iy}[n] - F_{Oy}[n])^2} \quad (67)$$

If one of the innermost or outermost fingers was not touching during the previous proximity image, the change in separation is assumed to be zero. Similarly, step 530 computes the hand rotational velocity H_{vr} from the change in angle between the innermost and outermost finger with approximately the following equation:

$$H_{vr}[n] = \left(\frac{L(FI[n], FO[n]) - L(FI[n-1], FO[n-1])}{\Delta t} \right) \times \left(\frac{d(FI[n], FO[n])}{\pi} \right) \quad (68)$$

The change in angle is multiplied by the current separation to convert it to the same units as the translation and scaling components. These equations capture any rotation and scaling components of hand motion even if the hand is also translating as a whole, thus making the rotation and scaling degrees of freedom integral with translation.

Another reason the computations above are restricted to the thumb and pinky or innermost and outermost fingers is that users may want to make fine translating manipulations with the central fingers, i.e., index, middle, and ring, while the thumb and pinky remain stationary. If changes in distances or angles between the central fingers and the thumb were averaged with Equations 66-68, this would not be possible because central finger translations would cause the appearance of rotation or scaling with respect to the stationary thumb or pinky. However, Equations 56-60 applied in the thumb verification process are only sensitive to symmetric rotation and scaling about a fixed point between the fingers. They approach zero if any significant whole hand translation is occurring or the finger motions are not complementary. In case the user fails to properly move the outermost finger during a rotation or scaling gesture, step 531 uses equations of the approximate form of Equations 56-60 to compute rotation and scaling velocities between the thumb and any touching fingers other than the outermost. The resulting velocities are preferably combined with the results of Equations 66-68 via a maximum operation rather than an average in case translational motion causes the fixed point rotations or scalings to be zero. Finally, decision diamond 532 orders a check for radial or rotational deceleration 534 during motions prior to finger liftoff. The method for detecting radial or rotational deceleration is the same as that detailed in the description of translation extraction.

FIG. 37 shows the details of hand translational velocity measurements referred to in process 506 of FIG. 34. The

simplest way to compute a hand translation velocity would be to simply average the lateral velocities of each finger. However, the user expects the motion or control to display gain to be constant regardless of how many fingers are being moved, even if some are resting stationary. Furthermore, if the user is simultaneously scaling or rotating the hand, a simple average is sensitive to spurious net translations caused by uncanceled central finger motions.

Therefore, in a preferred embodiment the translational component extractor carefully assigns weightings for each finger before computing the average translation. Step 540 initializes the translation weighting $F_{i_{vw}}$ of each finger to its total contact proximity, i.e., $F_{i_{vw}}[n] = F_{i_c}[n]$. This ensures that fingers not touching the surface do not dilute the average with their zero velocities and that fingers which only touch lightly have less influence since their position and velocity measurements may be less reliable. The next step 544 decreases the weightings of fingers which are relatively stationary so that the control to display gain of intentionally moving fingers is not diluted. This can be done by finding the fastest moving finger, recording its speed as a maximum finger speed and scaling each finger's translation weighting in proportion to its speed divided by the maximum of the finger speeds, as shown approximately in the formula below:

$$F_{i_{vw}}[n] = F_{i_{vw}}[n] \times \left(\frac{F_{i_{speed}}[n]}{\max_j F_{i_{speed}}[n]} \right)^{ptw} \quad (69)$$

where the power ptw adjusts the strength of the speed dependence. Note that step 544 can be skipped for applications such as computer-aided-design in which users desire both a normal cursor motion gain mode and a low gain mode. Lower cursor motion gain is useful for fine, short range positioning, and would be accessed by moving only one or two fingers while keeping the rest stationary.

Step 546 decreases the translation weightings for the central fingers during hand scalings and rotations, though it does not prevent the central fingers from making fine translational manipulations while the thumb and pinky are stationary. The formulas below accomplish this seamlessly by downscaling the central translation weightings as the magnitudes of the rotation and scaling velocities become significant compared to $K_{polarthresh}$:

$$F_{i_{vw}}[n] \approx \frac{F_{i_{vw}}[n] \times K_{polarthresh}}{K_{polarthresh} + |H_{vr}[n]|} \quad (70)$$

$$F_{i_{vw}}[n] \approx \frac{F_{i_{vw}}[n] \times K_{polarthresh}}{K_{polarthresh} + |H_{vr}[n]| + |H_{vs}[n]|} \quad (71)$$

where these equations are applied only to the central fingers whose identities i are between the innermost and outermost. Note that since hand scaling does not cause much horizontal translation bias, the horizontal translation weighting $F_{i_{vw}}[n]$ need not be affected by hand scaling velocity $H_{vs}[n]$, as indicated by the lack of a hand scaling term in Equation 70. The translation weightings of the innermost and outermost fingers are unchanged by the polar component speeds, i.e., $F_{i_{vw}}[n] = F_{i_{vw}}[n] = F_{i_{vw}}[n]$ and $F_{O_{vw}}[n] = F_{O_{vw}}[n] = F_{O_{vw}}[n]$. Step 548 finally computes the hand translation velocity vector $(H_{vx}[n], H_{vy}[n])$ from the weighted average of the finger velocities:

$$H_{vx}[n] = \frac{\sum_{i=1}^5 F_{iwx} F_{ixx}}{\sum_{i=1}^5 F_{iwx}} \quad (72)$$

$$H_{vy}[n] = \frac{\sum_{i=1}^5 F_{iwy} F_{iyx}}{\sum_{i=1}^5 F_{iwy}} \quad (73)$$

The last part of the translation calculations is to test for the lateral deceleration of the fingers before liftoff, which reliably indicates whether the user wishes cursor motion to stop at liftoff. If deceleration is not detected prior to liftoff, the user may intend cursor motion to continue after liftoff, or the user may intend a special "one-shot" command to be invoked. Decision diamond 550 only invokes the deceleration tests while finger proximities are not dropping too quickly, to prevent the perturbations in finger centroids which can accompany finger liftoff from interfering with the deceleration measurements. Step 551 computes the percentage acceleration or ratio of current translation speed $|H_{vx}[n], H_{vy}[n]|$ to a past average translation speed preferably computed by a moving window average or autoregressive filter. Decision diamond 552 causes the translation deceleration flag to be set 556 if the acceleration ratio is less than a threshold. If this threshold is set greater than one, the user will have to be accelerating the fingers just prior to liftoff for cursor motion to continue. If the threshold is set just below one, cursor motion will reliably be continued as long as the user maintains a constant lateral speed prior to liftoff, but if the user begins to slow the cursor on approach to a target area of the display the deceleration flag will be set. Decision diamond 554 can also cause the deceleration flag to be set if the current translation direction is substantially different from an average of past directions. Such change in direction indicates the hand motion trajectory is curving, in which case cursor motion should not be continued after liftoff because accurately determining the direction to the user's intended target becomes very difficult. If neither deceleration nor curved trajectories are detected, step 558 clears the translation deceleration flag. This will enable cursor motion continuation should the fingers subsequently begin liftoff. Note that decision diamond 550 prevents the state of the translation deceleration flags from changing during liftoff so that the decision after liftoff to continue cursor motion depends on the state of the deceleration flag before liftoff began. The final step 560 updates the autoregressive or moving window average of the hand translation velocity vector, which can become the velocity of continued cursor motion after liftoff. Actual generation of the continued cursor motion signals occurs in the chord motion recognizer 18 as will be discussed with FIG. 40.

Note that this cursor motion continuation method has several advantages over motion continuation methods in related art. Since the decision to continue motion depends on a percentage acceleration which inherently normalizes to any speed range, the user can intentionally invoke motion continuation from a wide range of speeds including very low speeds. Thus the user can directly invoke slow motion continuation to auto scroll a document at readable speeds. This is not true of Watanabe's method in U.S. Pat. No. 4,734,685, which only continues motion when the user's motion exceeds a high speed threshold, nor of Logan et al.'s method in U.S.

Pat. No. 5,327,161, which if enabled for low finger speeds will undesirably continue motion when a user decelerates on approach to a large target but fails to stop completely before lifting off. Percentage acceleration also captures user intent more clearly than position of a finger in a border area. Position of a finger in a border area as used in U.S. Pat. No. 5,543,591 to Gillespie et al. is ambiguous because the cursor can reach its desired target on the display just as the finger enters the border, yet the touchpad device will continue cursor motion past the target because it thinks the finger has run out of space to move. In the present invention, on the other hand, the acceleration ratio will remain near one if the fingers can slide off the edge of the sensing array without hitting a physical barrier, sensibly invoking motion continuation. But if the fingers decelerate before crossing or stop on the edge of the sensing array, the cursor will stop as desired.

The details of the differential hand pressure extraction process 508 are shown in FIG. 38. Fingertip proximity, quickly saturates when pressure is applied through the bony tip normal to a hard surface. Unless the surface itself is highly compliant, the best dynamic range of fingertip pressure is obtained with the fingers outstretched and hand nearly flattened so that the compressible soft pulp underneath the fingertips rests on the surface. Decision diamond 562 therefore causes the tilt and roll hand pressure components to be set to zero in step 564 and pressure extraction to abort unless the hand is nearly flattened. Inherent in the test for hand flattening 562 is a finger count to ensure that most of the five fingers and both palm heels are touching the surface to maximize the precision of the hand pressure measurements, though technically only three non-collinear hand contacts arranged like a tripod are necessary to establish tilt and roll pressures. Decision diamond 562 can also require the user to explicitly enable three-dimensional manipulation with an intuitive gesture such as placing all five fingers on the surface briefly tapping the palm heels on the surface, and finally resting the palm heels on the surface. Decision diamond 566 causes step 568 to capture and store reference proximities for each contact path when the proximity of all contacts have stabilized at the end of this initiation sequence. The tilt and roll pressure components are again zeroed 564 for the sensor array scan cycle during which this calibration is performed.

However, during subsequent scan cycles the user can tilt the hand forward applying more pressure to the fingertips or backward applying more pressure to the palm heels or the user can roll the hand outward onto the pinky and outer palm heel or inward applying more pressure to the thumb, index finger and inner palm heel. Step 5170 will proceed to calculate an unweighted average of the current contact positions. Step 572 computes for each hand part still touching the surface the ratio of current proximity to the reference proximity previously stored. To make these ratios less sensitive to accidental lifting of hand parts, step 574 clips them to be greater or equal to one so only increases in proximity and pressure register in, the tilt and roll measurements. Another average contact path position is computed in step 576, but this one is weighted by the above computed proximity ratios for each path. The difference between these weighted and unweighted contact position averages taken in step 578 produces a vector whose direction can indicate the direction of roll or tilt and whose magnitude can control the rate of roll or tilt about x and y axes.

Since the weighted and unweighted position averages are only influenced by positions of currently contacting fingers and increases in contact pressure or proximity, the method is insensitive to finger liftoffs. Computation of reference-normalized proximity ratios in step 572 rather than absolute

changes in proximity prevents the large palm heel contacts from having undue influence on the weighted average position.

Since only the current contact positions are used in the average position computations, the roll and tilt vector is independent of lateral motions such as hand translation or rotation as long as the lateral motions do not disturb finger pressure, thus once again achieving integrality. However, hand scaling and differential hand pressure are difficult to use at the same time because flexing the fingers generally causes significant decreases in fingertip contact area and thus interferes with inference of fingertip pressure changes. When this becomes a serious problem, a total hand pressure component can be used as a sixth degree of freedom in place of the hand scaling component. This total pressure component causes cursor velocity along a z-axis in proportion to deviations of the average of the contact proximity ratios from one. Alternative embodiments may include further enhancements such as adapting the reference proximities to slow variations in resting hand pressure and applying a dead zone filter to ignore pressure difference vectors with small magnitudes

Despite the care taken to measure the polar velocity, translation velocity, and hand pressure components in such a way that the resultant vectors are independent of one another, uneven finger motion during hand scaling, rotation, or translation can still cause minor perturbations in measurements of one degree of freedom while primarily attempting to move in another. Non-linear filtering applied in steps 510 and 512 of FIG. 34 removes the remaining motion leakage between dominant components and nearly stationary components. In steps 510 each component velocity is downscaled by the ratio of its average speed to the maximum of all the component speeds, the dominant component speed:

$$H_{vx}[n] = H_{vx}[n] \times \left(\frac{H_{xyspeed}[n]}{\text{dominant_speed}} \right)^{pds} \quad (74)$$

$$H_{vy}[n] = H_{vy}[n] \times \left(\frac{H_{xyspeed}[n]}{\text{dominant_speed}} \right)^{pds} \quad (75)$$

$$H_{vs}[n] = H_{vs}[n] \times \left(\frac{H_{speed}[n]}{\text{dominant_speed}} \right)^{pds} \quad (76)$$

$$H_{vr}[n] = H_{vr}[n] \times \left(\frac{H_{speed}[n]}{\text{dominant_speed}} \right)^{pds} \quad (77)$$

where $H_{xyspeed}[n]$, $H_{speed}[n]$, and $H_{speed}[n]$ are autoregressive averages over time of the translation speed, scaling speed, and rotational speed, where:

$$\text{dominant_speed} = \max(H_{xyspeed}[n], H_{speed}[n], H_{speed}[n]) \quad (78)$$

where pds controls the strength of the filter. As pds is adjusted towards infinity the dominant component is picked out and all components less than the dominant tend toward zero producing the orthogonal cursor effect well-known in drawing applications. As pds is adjusted towards zero the filters have no effect. Preferably, pds is set in between so that components significantly slower than the dominant are slowed further, but components close to the dominant in speed are barely affected, preserving the possibility of diagonal motion in multiple degrees of freedom at once. The autoregressive averaging helps to pick out the component or components which are dominant over the long term and suppress the others even while the dominant components are slowing to a stop.

Step 512 takes a second pass with a related filter known as a dead-zone filter. A dead-zone filter produces zero output velocity for input velocities less than a speed threshold but produces output speeds in proportion to the difference between the input speed and the threshold for input velocities that exceed the threshold. Preferably the speed threshold or width of the dead zone is set to a fraction of the maximum of current component speeds. All velocity components are filtered using this same dead zone width. The final extracted component velocities are forwarded to the chord motion recognizer module 18 which will determine what if any input events should be generated from the motions.

FIG. 39A shows the details of the finger synchronization detector module 14. The synchronization detection process described below is repeated for each hand independently. Step 600 fetches proximity markers and identifications for the hand's current paths. The identifications will be necessary to ignore palm paths and identify combinations of synchronized fingers, while the proximity markers record the time at which each contact path first exceeds a press proximity threshold and the time at which each contact path drops below a release proximity threshold prior to total liftoff. Setting these proximity thresholds somewhat higher than the minimum proximity considered significant by the segmentation search process 264, produces more precise finger press and release times.

Step 603 searches for subsets of fingers which touch down at about the same time and for subsets of fingers which lift off at about the same time. This can be done by recording each finger path along with its press time in a temporally ordered list as it crosses the press proximity threshold. Since the primary function of the palms is to support the forearms while the hands are resting, palm activity is ignored by the typing 12 and chord motion recognizers 18 except during differential hand pressure extraction and palm heel presses can be excluded from this list and most other synchronization tests. To check for synchronization between the two most recent finger presses, the press times of the two most recent entries in the list are compared. If the difference between their press times is less than a temporal threshold, the two finger presses are considered synchronized. If not, the most recent finger press is considered asynchronous. Synchronization among three or more fingers up to five is found by comparing press times of the three, four, or five most recent list entries. If the press time of the most recent entry is within a temporal threshold of the nth most recent entry, synchronization among the n most recent finger presses is indicated. To accommodate imprecision in touchdown across the hand, the magnitude of the temporal threshold should increase slightly in proportion to the number of fingers being tested for synchronization. The largest set of recent finger presses found to be synchronized is recorded as the synchronized subset, and the combination of finger identities comprising this subset is stored conveniently as a finger identity bitfield. The term subset is used because the synchronized press subset may not include all fingers currently touching the surface, as happens when a finger touches down much earlier than the other fingers yet remains touching as they simultaneously touch down. An ordered list of finger release times is similarly maintained and searched separately. Alternative embodiments may require that a finger still be touching the surface to be included in the synchronized press subset.

Decision diamond 602 checks whether a synchronization marker is pending from a previous image scan cycle. If not, decision diamond 604 checks whether the search 603 found a newly synchronized press subset in the current proximity image. If so, step 606 sets the temporal synchronization

marker to the oldest press within the new synchronized subset. Additional finger presses may be added to the subset during future scan cycles without affecting the value of this temporal synchronization marker. If there is currently no finger press synchronization, decision diamond 605 determines whether three or more fingers have just been released simultaneously. Simultaneous release of three or more fingers should not occur while typing with a set of fingers but does occur when lifting fingers off the surface from rest. Therefore simultaneous release of three or more fingers reliably indicates that the released fingers are not intended as keypresses and should be deleted from the keypress queue 605, regardless of whether these same fingers touched down synchronously. Release synchronization of two fingers is not by itself a reliable indicator of typing intent and has no effect on the keypress queue. The keypress queue is described later with FIGS. 42-43B.

Once a press synchronization marker for the hand is pending, further processing checks the number of finger presses which are synchronized and waits for release of the synchronized fingers. If decision diamond 608 finds three or more fingers in the synchronized press subset the user cannot possibly be typing with these fingers. Therefore step 612 immediately deletes the three or more synchronized presses from the keypress queue. This way they cannot cause key symbol transmission to the host, and transmission of key symbols for subsequent asynchronous presses is not blocked waiting for the synchronized fingers to be released.

However, when the synchronization only involves two finger presses 608, it is difficult to know whether the user intended to tap a finger pair chord or intended to type two adjacent keys and accidentally let the key presses occur simultaneously. Since such accidental simultaneous presses are usually followed by asynchronous releases of the two fingers, but finger pair chords are usually released synchronously, the decision whether the presses are asynchronous key taps or chord taps must be delayed until finger release can be checked for synchronization. In the meantime, step 610 places a hold on the keypress queue to prevent transmission of key symbols from the possible finger chord or any subsequent finger presses. To prevent long backups in key transmission, decision diamond 614 will eventually release the queue hold by having step 615 delete the synchronized presses from the keypress queue if both fingers remain touching a long time. Though this aborts the hypothesis that the presses were intended as key taps, the presses are also less likely to be key taps if the fingers are not lifted soon after touchdown.

If the synchronized fingers are not lifting, decision diamond 616 leaves the synchronization marker pending so synchronization checks can be continued with updated path parameters 600 after the next scan cycle. If the synchronized fingers are lifting, but decision diamond 618 finds with the help of the synchronization release search 603 that they are doing so asynchronously 618, step 622 releases any holds on the keypress queue assuming any synchronized finger pair was intended to be two keypresses. Though the synchronized finger presses are not deleted from the keypress queue at this point, they may have already been deleted in step 612 if the pressed subset contained more than two. Also, step 624 clears the temporal synchronization marker, indicating that no further synchronization tests need be done for this subset.

Continuing to FIG. 39B, if the fingers synchronized during touchdown also lift simultaneously, step 618 removes them and any holds from the keypress queue in case they were a pair awaiting a positive release synchronization test. Further tests ensue to determine whether the synchronized fingers meet additional chord tap conditions. As with single finger

taps, the synchronized fingers cannot be held on the surface more than about half a second if they are to qualify, as a chord tap. Decision diamond 626 tests this by thresholding the time between the release of the last remaining synchronized finger and the temporal press synchronization marker. A chord tap should also exhibit a limited amount of lateral finger motion, measured either as an average of peak finger speeds or distance traveled since touchdown in decision diamond 628. If the quick release and limited lateral motion conditions are not met, step 624 clears the synchronization marker with the conclusion that the synchronized fingers were either just resting fingers or part of a chord slide.

If the chord tap conditions are met, step 630 looks up, using the synchronized subset bitfield, any input events such as mouse clicks or keyboard commands assigned to the combination of fingers in the chord tap. Some chords such as those including all four fingertips may be reserved as resting chords 634, in which case decision diamond 632 will find they have no associated input events. If the chord does have tap input events, step 636 appends these to the main outgoing event queue of the host communication interface 20. Finally step 624 clears the synchronization marker in readiness for future finger synchronizations on the given hand.

As a further precaution against accidental generation of chord taps while typing, it is also useful for decision diamond 632 to ignore through step 634 the first chord tap which comes soon after a valid keypress without a chord slide in between. Usually after typing the user will need to reposition the mouse cursor before clicking, requiring an intervening chord slide. If the mouse cursor happens to already be in place after typing, the user may have to tap the finger chord a second time for the click to be sent, but this is less risky than having an accidental chord tap cause an unintended mouse button click in the middle of a typing session.

FIG. 40A shows the detailed steps of the chord motion recognizer module 18. The chord motion recognition process described below is repeated for each hand independently. Step 650 retrieves the parameters of the hand's identified paths 250 and the hand's extracted motion components from the motion extraction module 16. If a slide of a finger chord has not already started, decision diamond 652 orders slide initiation tests 654 and 656. To distinguish slides from glancing finger taps during typing, decision diamond 654 requires at least two fingers from a hand to be touching the surface for slide mode to start. There may be some exceptions to this rule, such as allowing a single finger to resume a previous slide within a second or so after the previous slide chord lifts off the surface.

In a preferred embodiment, the user can start a slide and specify its chord in either of two ways. In the first way, the user starts with the hand floating above the surface, places some fingers on the surface possibly asynchronously, and begins moving all of these fingers laterally. Decision diamond 656 initiates the slide mode only when significant motion is detected in all the touching fingers. Step 658 selects the chord from the combination of fingers touching when significant motion is detected, regardless of touchdown synchronization. In this case coherent initiation of motion in all the touching fingers is sufficient to distinguish the slide from resting fingers, so synchronization of touchdown is not necessary. Also, novice users may erroneously try to start a slide by placing and sliding only one finger on the surface, forgetting that multiple fingers are necessary. Tolerance of asynchronous touchdown allows them to seamlessly correct this by subsequently placing and sliding the rest of the fingers desired for

US 7,812,828 B2

51

the chord. The slide chord will then initiate without forcing the user to pick up all fingers and start over with synchronized finger touchdowns.

In the second way, the user starts with multiple fingers resting on the surface, lifts a subset of these fingers, touches a subset back down on the surface synchronously to select the chord, and begins moving the subset laterally to initiate the slide. Decision diamond 656 actually initiates the slide mode when it detects significant motion in all the fingers of the synchronized subset. Whether the fingers which remained resting on the surface during this sequence begin to move does not matter since in this case the selected chord is determined in step 658 by the combination of fingers in the synchronized press subset, not from the set of all touching fingers. This second way has the advantage that the user does not have to lift the whole hand from the surface before starting the slide, but can instead leave most of the weight of the hands resting on the surface and only lift and press the two or three fingers necessary to identify the most common finger chords.

To provide greater tolerance for accidental shifts in resting finger positions, decision diamond 656 requires both that all relevant fingers are moving at significant speed and that they are moving about the same speed. This is checked either by thresholding the geometric mean of the finger speeds or by thresholding the fastest finger's speed and verifying that the slowest finger's speed is at least a minimum fraction of the fastest finger's speed. Once a chord slide is initiated, step 660 disables recognition of key or chord taps by the hand at least until either the touching fingers or the synced subset lifts off.

Once the slide initiates, the chord motion recognizer could simply begin sending raw component velocities paired with the selected combination of finger identities to the host. However, in the interest of backward compatibility with the mouse and key event formats of conventional input devices, the motion event generation steps in FIG. 40B convert motion in any of the extracted degrees of freedom into standard mouse and key command events which depend on the identity of the selected chord. To support such motion conversion, step 658 finds a chord activity structure in a lookup table using a bitfield of the identities of either the touching fingers or the fingers in the synchronized, subset. Different finger identity combinations can refer to the same chord activity structure. In the preferred embodiment, all finger combinations with the same number of non-thumb fingertips refer to the same chord activity structure, so slide chord activities are distinguished by whether the thumb is touching and how many non-thumb fingers are touching. Basing chord action on the number of fingertips rather than their combination still provides up to seven chords per hand yet makes chords easier for the user to memorize and perform. The user has the freedom to choose and vary which fingertips are used in chords requiring only one; two or three fingertips. Given this freedom, users naturally tend to pick combinations in which all touching fingertips are adjacent rather than combinations in which a finger such as the ring finger is lifted but the surrounding fingers such as the middle and pinky must touch. One chord typing study found that users can tap these finger chords in which all pressed fingertips are adjacent twice as fast as other chords.

The events in each chord activity structure are organized into slices. Each slice contains events to be generated in response to motion in a particular range of speeds and directions within the extracted degrees of freedom. For example, a mouse cursor slice could be allocated any translational speed and direction. However, text cursor manipulation requires four slices, one for each arrow key, and each arrow's slice integrates motion in a narrow direction range of translation. Each slice can also include motion sensitivity and so-called

52

cursor acceleration parameters for each degree of freedom. These will be used to discretize motion into the units such as arrow key clicks or mouse clicks expected by existing host computer systems.

Step 675 of chord motion conversion simply picks the first slice in the given chord activity structure for processing. Step 676 scales the current values of the extracted velocity components by the slice's motion sensitivity and acceleration parameters. Step 677 geometrically projects or clips the scaled velocity components into the slice's defined speed and direction range. For the example mouse cursor slice, this might only involve clipping the rotation and scaling components to zero. But for an arrow key slice, the translation velocity vector is projected onto the unit vector pointing in the same direction as the arrow. Step 678 integrates each scaled and projected component velocity over time in the slice's accumulators until decision diamond 680 determines at least one unit of motion has been accumulated. Step 682 looks up the slice's preferred mouse, key, or three-dimensional input event format, attaches the number of accumulated motion units to the event; and step 684 dispatches the event to the outgoing queue of the host communication interface 20. Step 686 subtracts the sent motion events from the accumulators, and step 688 optionally clears the accumulators of other slices. If the slice is intended to generate a single key command per hand motion, decision diamond 689 will determine that it is a one-shot slice so that step 690 can disable further event generation from it until a slice with a different direction intervenes. If the given slice is the last slice, decision diamond 692 returns to step 650 to await the next scan of the sensor array. Otherwise step 694 continues to integrate and convert the current motion for other slices.

Returning to FIG. 40A, for some applications it may be desirable to change the selected chord whenever an additional finger touches down or one of the fingers in the chord lifts off. However, in the preferred embodiment, the selected chord cannot be changed after slide initiation by asynchronous finger touch activity. This gives the user freedom to rest or lift addition fingers as may be necessary to get the best precision in a desired degree of freedom. For example, even though the finger pair chord does not include the thumb, the thumb can be set down shortly after slide initiation to access the full dynamic range of the rotation and scaling degrees of freedom. In fact, all remaining lifted fingers can always be set down after initiation of any chord to allow manipulation by the whole hand. Likewise, all fingers but one can be lifted, yet translation will continue.

Though asynchronous finger touch activity is ignored, synchronized lifting and pressing of multiple fingers subsequent to slide initiation can create a new synchronized subset and change the selected chord. Preferably this is only allowed while the hand has paused but its fingers are still resting on the surface. Decision diamond 670 will detect the new subset and commence motion testing in decision diamond 673 which is analogous to decision diamond 656. If significant motion is found in all fingers of the newly synchronized subset, step 674 will select the new subset as the slide chord and lookup a new chord activity structure in analogy to step 658. Thus finger synchronization again allows the user to switch to a different activity without forcing the user to lift the whole hand from the surface. Integration of velocity components resumes but the events generated from the new chord activity structure will presumably be different.

It is advantageous to provide visual or auditory feedback to the user about which chord activity structure has been selected. This can be accomplished visually by placing a row of five light emitting diodes across the top of the multi-touch

US 7,812,828 B2

53

surface, with one row per hand to be used on the surface. When entering slide mode, step 658 would turn on a combination of these lights corresponding to the combination of fingers in the selected chord. Step 674 would change the combination of active lights to match the new chord activity structure should the user select a new, chord, and step 668 would turn them off. Similar lights could be emulated on the host computer display 24. The lights could also be flashed to indicate the finger combination detected during chord taps in step 636. The implementation for auditory feedback would be similar, except light combinations would be replaced with tone or tone burst combinations.

The accumulation and event generation process repeats for all array scan cycles until decision diamond 664 detects liftoff by all the fingers from the initiating combination. Decision diamond 666 then checks the pre-liftoff deceleration flag of the dominant motion, component. The state of this flag is determined by step 556 or 558 of translation extraction (FIG. 37) if translation is dominant, or by corresponding flags in step 534 of polar extraction. If there has been significant deceleration, step 668 simply exits the chord slide mode, setting the selected chord to null. If the flag indicates no significant finger deceleration prior to liftoff, decision diamond 666 enables motion continuation mode for the selected chord. While in this mode, step 667 applies the pre-liftoff weighted average (560) of dominant component velocity to the motion accumulators (678) in place of the current velocities, which are presumably zero since no fingers touch the surface. Motion continuation mode does not stop until any of the remaining fingers not in the synchronized subset are lifted or more fingers newly touch down. This causes decision diamond 664 to become false and normal slide activity with the currently selected chord to resume. Though the cursor or scrolling velocity does not decay during motion continuation mode, the host computer can send a signal instructing motion continuation mode to be canceled if the cursor reaches the edge of the screen or end of a document. Similarly, if any fingers remain on the surface during motion continuation, their translations can adjust the cursor or scrolling velocity.

In the preferred embodiment, the chord motion recognizers for each hand function independently and the input events for each chord can be configured independently. This allows the system to allocate tasks between hands in many different ways and to support a variety of bimanual manipulations. For example, mouse cursor motion can be allocated to the fingertip pair chord on both hands and mouse button drag to a triple fingertip chord on both hands. This way the mouse pointer can be moved and drag with either hand on either half of the surface. Primary mouse clicks would be generated by a tap of a fingertip pair on either half of the surface, and double-clicks could be ergonomically generated by a single tap of three fingertips on the surface. Window scrolling could be allocated to slides of four fingers on either hand.

Alternatively, mouse cursor manipulations could be allocated as discussed above to the right hand and right half of the surface, while corresponding text cursor manipulations are allocated to chords on the left hand. For instance, left fingertip pair movement would generate arrow key commands corresponding to the direction of motion, and three fingertips would generate shift arrow combinations for selection of text.

For host computer systems supporting manipulations in three or more degrees of freedom, a left hand chord could be selected to pan, zoom, and rotate the display background while a corresponding chord in the right hand could translate, resize and rotate a foreground object. These chords would not have to include the thumb since the thumb can touch down anytime after initiating chord motion without changing the

54

selected chord. The user then need add the thumb to the surface when attempting rotation or scaling.

Finger chords which initially include the thumb can be reserved for one-shot command gestures, which only generate input events once for each slide of a chord rather than repeating transmission each time an additional unit of motion is detected. For example, the common editing commands cut, copy and paste can be intuitively allocated to a pinch hand scaling, chord tap, and anti-pinch hand scaling of the thumb and an opposing fingertip.

FIG. 41 shows the steps within the key layout definition and morphing process, which is part of the typing recognition module 12. Step 700 retrieves at system startup a key layout which has been pre-specified by the user or manufacturer. The key layout consists of a set of key region data structures. Each region has associated with it the symbol or commands which should be sent to the host computer when the region is pressed and coordinates representing the location of the center of the region on the surface. In the preferred embodiment, arrangement of those key regions containing alphanumeric and punctuation symbols roughly corresponds to either the QWERTY or the Dvorak key layouts common on mechanical keyboards.

In some embodiments of the multi-touch surface apparatus it is advantageous to be able to snap or morph the key layout to the resting positions of the hands. This is especially helpful for multi-touch surfaces which are several times larger than the standard keyboard or key layout, such as one covering an entire desk. Fixing the key layout in one small fixed area of such a surface would be inconvenient and discourage use of the whole available surface area. To provide feedback to the user about changes in the position of the key layout, the position of the key symbols in these embodiments of the multi-touch surface would not be printed permanently on the surface. Instead, the position of the key symbols would be reprogrammably displayed on the surface by light emitting polymers, liquid crystal, or other dynamic visual display means embedded in the multi-touch surface apparatus along with the proximity sensor arrays.

Given such an apparatus, step 702 retrieves the current paths from both hands and awaits what will be known as a layout homing gesture. If decision diamond 704 decides with the help of, a hand's synchronization detector that all five of the hand's fingers have just been placed on the surface synchronously, step 706 will attempt to snap the key layout to the hand such that the hand's home row keys lie under the synchronized fingertips, wherever the hand is on the surface. Step 706 retrieves the measured hand offsets from the hand position estimator and translates all key regions which are normally typed by the given hand in proportion to the measured hand offsets. Note the currently measured rather than filtered estimates of offsets can be used because when all five fingers are down there is no danger of finger misidentification corrupting the measured offsets. This procedure assumes that the untranslated locations of the home row keys are the same as the default finger locations for the hand.

Decision diamond 708 checks whether the fingers appear to be in a neutral, partially closed posture, rather closed than outstretched or pinched together. If the posture is close to neutral, step 710 may further offset the keys normally typed by each finger, which for the most part are the keys in the same column of the finger by the measured finger offsets. Temporal filtering of these finger offsets over several layout homing gestures will tend to scale the spacing between columns of keys to the user's hand size. Spacing between rows is scaled down in proportion to the scaling between columns.

With the key layout for the hand's keys morphed to fit the size and current position of the resting hand, step 712 updates

US 7,812,828 B2

55

the displayed position of the symbols on the surface, so that the user will see that the key layout has snapped to the position of his hand. From this stage the user can begin to type and the typing recognizer 718 will use the morphed key region locations to decide what key regions are being pressed. The layout will remain morphed this way until either the user performs another homing gesture to move it somewhere else on the surface, or until the user takes both hands off the surface for a while. Decision diamond 714 will eventually time out so that step 716 can reset the layout to its default position in readiness for another user or usage session.

For smaller multi-touch surfaces in which the key layout is permanently printed on the surface, it is advantageous to give the user tactile feedback about the positions of key regions. However, any tactile indicators placed on the surface must be carefully designed so as not to impede smooth sliding across the surface. For example, shallow depressions made in the surface near the center of each key mimicking the shallow depressions common on mechanical keyboard keycaps would cause a vibratory washboard effect as the hand slides across the surface. To minimize such washboard effects, in the preferred embodiment the multi-touch surface provides for the fingertips of each hand a single, continuous depression running from the default index fingertip location to the default pinky fingertip location. This corresponds on the QWERTY key layout to shallow, slightly arched channels along home row from the "J" key to the ";" key for the right hand, and from the "A" key to the "F" key for the left hand. Similarly, the thumbs can each be provided with a single oval-shaped depression at their default locations, slanted slightly from vertical to match the default thumb orientation. These would preferably correspond to "Space" and "BackSpace" key regions for the right and left thumbs, respectively. Such minimal depressions can tactilely guide users' hands back to home row of the key layout without requiring users to look down at the surface and without seriously disrupting finger chord slides and manipulations on the surface.

The positions of key regions off home row can be marked by other types of tactile indicators. Simply roughening the surface at key regions does not work well. Though humans easily differentiate textures when sliding fingers over them, most textures cannot be noticed during quick taps on a textured region. Only relatively abrupt edges or protrusions can be sensed by the users' fingertips under typing conditions. Therefore, a small raised dot like a Braille dot is formed on top of the surface at the center of each key region. The user receives feedback on the accuracy of their typing strokes from where on the fingertip a dot is felt. This feedback can be used to correct finger aim during future keypresses. Since single finger slides are ignored by the chord motion recognizer, the user can also slide a finger around the surface in tactile search of a particular key region's dot and then tap the key region when the dot is found, all without looking at the surface. Each dot should be just: large enough to be felt during tapping but not so large as to impede chord slides across the surface. Even if the dots are not large enough to impede sliding, they can still corrupt proximity and fingertip centroid measurements by raising the fingertip flesh near the dot off the surface thus locally separating the flesh from the underlying proximity sensing electrode. Therefore, in the preferred embodiment, the portion of each dot above the surface dielectric is made of a conductive material. This improves capacitive coupling between the raised fingertip flesh and the underlying electrodes.

FIG. 42 shows the steps within the keypress detection loop. Step 750 retrieves from the current identified path data 250 any paths which were recently created due to hand part touch-

56

down or the surface. Decision diamond 752 checks whether the path proximity reached a keypress proximity thresh for the first time during the current sensor array scan. If the proximity has not reached the threshold yet or has already exceeded it previously, control returns to step 750 to try keypress detection on the next recent path. If the path just crossed the keypress proximity threshold decision diamond 754 checks whether the contact path has been identified as a finger rather than a palm. To give the users the freedom rest the palms anywhere on the surface, palm presses should not normally cause keypresses, and are therefore ignored. Assuming the path is a finger, decision diamond 756 checks whether the hand the identified finger comes from is currently performing a chord slide gesture or writing via the pen grip hand configuration. Asynchronous finger presses are ignored once these activities have started, as also indicated in step 660 of FIG. 40A. Assuming such hand activities are not ongoing, decision diamond 757 proceeds with debounce tests which check that the finger has touched the surface for at least two sensor array scan cycles and that it had been off the surface for several scan cycles before touching down. The path tracking module (FIG. 22) facilitates such liftoff debouncing by reactivating in step 334 a finger's old path if the finger lifts off and quickly touches back down over the same spot. Upon reactivation the time stamp of the last liftoff by the old path must be preserved for comparison with the time stamp of the new touchdown.

If all of these tests are passed, step 758 looks up the current path position ($P_x[n], P_y[n]$), and step 760 finds the key region whose reference position is closest to the fingertip centroid. Decision diamond 762 checks that the nearest region is within a reasonable distance of the finger, and if not causes the finger press to be ignored. Assuming a key region is close to the finger, step 764 creates a keypress element data structure containing the path, index identifier and finger identity, the closest key region, and a time stamp indicating when the finger crossed the keypress proximity threshold. Step 766 then appends this element data structure to the tail of a FIFO keypress queue. This accomplished, processing returns to step 750 to process or wait for touchdowns by other fingers.

The keypress queue effectively orders finger touchdowns by when they pass the keypress transmitted to the host. However, an element's key symbol is not assured transmission of the host once in the keypress queue. Any of a number of conditions such as being part of a synchronized subset of pressing fingers can cause it to be deleted from the queue before being transmitted to the host. In this sense the keypress queue should be considered a keypress candidate queue. Unlike the ordered lists of finger touchdowns and releases maintained for each hand separately in the synchronization detector, the keypress queue includes and orders the finger touchdowns from both hands.

FIG. 43A shows the steps within the keypress acceptance and transmission loop. Step 770 picks the element at the head of the keypress queue, which represents the oldest finger touchdown which has neither been deleted from the queue as an invalid keypress candidate nor transmitted its associated key symbol. Decision diamond 772 checks whether the path is still identified as a finger. While waiting in the queue path proximity could have increased so much that the identification system decides the path is actually from a palm heel, in which case step 778 deletes the keypress element without transmitting to the host and step 770 advances processing to the next element. Decision diamond 774 also invalidates the element if its press happened synchronously with other fingers of the same hand. Thus decision diamond 774 follows through on deletion command steps 601, 612, 615, 620 of the

US 7,812,828 B2

57

synchronization detection process (FIG. 39). Decision diamond 776 invalidates the keypress if too much lateral finger motion has occurred since touchdown, even if that lateral finger motion has not yet caused a chord slide to start. Because users may be touch typing on the surface, several millimeters of lateral motion are allowed to accommodate glancing fingertip motions which often occur when quickly reaching for keys. This is much more glancing tap motion than is tolerated by touchpads which employ a single finger slide for mouse cursor manipulation and a single finger tap for key or mouse button click emulation.

Decision diamond 780 checks whether the finger whose touchdown created the keypress element has since lifted off the surface. If so, decision diamond 782 checks whether it was lifted off soon enough to qualify as a normal key tap. If so, step 784 transmits the associated key symbol to the host and step 778 deletes it from the head of the queue. Note that a keypress is always deleted from the queue upon liftoff, but even though it may have stayed on the surface for a time exceeding the tap timeout, it may have still caused transmission as a modifier key, as an impulsive press with hand resting, or as a typematic press, as described below.

When a keypress is transmitted to the host it is advantageous for a sound generation device on the multi-touch surface apparatus or host computer to emit an audible click or beep as feedback to the user. Generation of audible click and beep feedback in response to keypresses is well known in commercial touchscreens, kiosks, appliance control panels and mechanical keyboards in which the keyswitch action is nearly silent and does not have a make force threshold which feels distinctive to the user. Feedback can also be provided as a light on the multi-touch surface apparatus which flashes each time a keypress is sent. Keypresses accompanied by modifier keypresses should cause longer flashes or tones to acknowledge that the key symbol includes modifiers.

If the finger has not yet lifted, decision diamond 786 checks whether its associated key region is a modifier such as <shift>, <ctrl>, or <alt>. If so, step 788 advances to the next element in the queue without deleting the head. Processing will continue at step 772 to see if the next element is a valid key tap. If the next element successfully reaches the transmission stage, step 784 will scan back toward the head of the queue for any modifier regions which are still pressed. Then step 784 can send the next element's key symbol along with the modifying symbols of any preceding modifier regions.

Decision diamond 782 requires that users touch the finger on the surface and lift back off within a few hundred milliseconds for a key to be sent. This liftoff timing requirement substitutes for the force activation threshold of mechanical keyswitches. Like the force threshold of mechanical keyswitches, the timing constraint provides a way for the user to rest the finger on the key surface without invoking a keypress. The synchronization detector 14 provides another way for fingers to rest on the surface without generating key symbols: they must touch down at the same time as at least one other finger. However, sometimes users will start resting by simultaneously placing the central fingertips on the surface, but then they follow asynchronously with the pinky a second later and the thumb a second after that. These latter presses are essentially asynchronous and will not be invalidated by the synchronization detector, but as long as they are not lifted within a couple hundred milliseconds, decision diamond 782 will delete them without transmission. But, while decision diamond 782 provides tolerance of asynchronous finger resting, its requirement that fingers quickly lift off, i.e., crisply tap, the surface to cause key generation makes it very difficult to keep most of the fingers resting on the surface to support the

58

hands while tapping long sequences of symbols. This causes users to raise their hands off the surface and float them above the surface during fast typing sequences. This is acceptable typing posture except that the users arms will eventually tire if the user fails to rest the hands back on the surface between sequences.

To provide an alternative typing posture which does not encourage suspension of the hands above the surface, decision diamond 790 enables a second key acceptance mode which does not require quick finger liftoff after each press. Instead, the user must start with all five fingers of a hand resting on the surface. Then each time a finger is asynchronously raised off the surface and pressed on a key region, that key region will be transmitted regardless of subsequent liftoff timing. If the surface is hard such that fingertip proximity quickly saturates as force is applied, decision diamond 792 checks the impulsivity of the proximity profile for how quickly the finger proximity peaks. If the proximity profile increases to its peak very slowly over time, no key will be generated. This allows the user to gently set down a raised finger without generating a key in case the user lifts the finger with the intention of generating a key but then changes his mind. If the touch surface is compressible, decision diamond 792 can more directly infer finger force from the ratio of measured fingertip proximity to ellipse axis lengths. Then it can threshold the inferred force to distinguish deliberate key presses from gentle finger rests. Since when intending to generate a key the user will normally press down on the new key region quickly after lifting off the old key region, the impulsivity and force thresholds should increase with the time since the finger lifted off the surface.

Emulating typematic on a multi-touch surface presents special problems if finger resting force cannot be distinguished reliably from sustained holding force on a key region. In this case, the special touch timing sequence detected by the steps of FIG. 43B supports reliable typematic emulation. Assuming decision diamond 798 finds that typematic has not started yet, decision diamond 794 checks whether the keypress queue element being processed represents the most recent finger touchdown on the surface. If any finger touch-downs have followed the touchdown represented by this element, typematic can never start from this queue element. Instead, decision diamond 796 checks whether the element's finger has been touching longer than the normal tap timeout. If the finger has been touching too long, step 778 should delete its keypress element because decision diamond 786 has determined it is not a modifier and decision diamond 794 has determined it can never start typematic. If decision diamond 794 determines that the keypress element does not represent the most recent touchdown, yet decision diamond 796 indicates the element has not exceeded the tap timeout, processing returns to step 770 to await either liftoff or timeout in a future sensor array scan. This allows finger taps to overlap in the sense that a new key region can be pressed by a finger before another finger lifts off the previous key region. However, either the press times or release times of such a pair of overlapping finger taps must be asynchronous to prevent the pair from being considered a chord tap.

Assuming the finger touchdown is the most recent, decision diamond 800 checks whether the finger has been touching for a typematic hold setup interval of between about half a second and a second. If not, processing returns to 770 to await either finger liftoff or the hold setup condition to be met during future scans of the sensor array. When the hold setup condition is met, decision diamond 802 checks whether all other fingers on the hand of the given finger keypress lifted off the surface more than a half second ago. If they did, step 804

US 7,812,828 B2

59

will initialize typematic for the given keypress element. The combination of decision diamonds 800 and 802 allow the user to have other fingers of the hand to be resting on the surface when a finger intended for typematic touches down. But typematic will not start unless the other fingers lift off the surface within half a second of the desired typematic finger's touchdown, and typematic will also not start until the typematic finger has a continued to touch the surface for at least half a second after the others lifted off the surface. If these stringent conditions are not met, the keypress element will not start typematic and will eventually be deleted through either tap timeout 782 when the finger lifts off or through tap timeout 796) if another touches down after it.

Step 804 simply sets a flag which will indicate to decision diamond 798 during future scan cycles that typematic has already started for the element. Upon typematic initialization, step 810 sends out the key symbol for the first time to the host interface communication queue, along with any modifier symbols being held down by the opposite hand. Step 812 records the time the key symbol is sent for future reference by decision diamond 808. Processing then returns to step 770 to await the next proximity image scan.

Until the finger lifts off or another taps asynchronously, processing will pass through decision diamond 798 to check whether the key symbol should be sent again. Step 806 computes the symbol repeat interval dynamically to be inversely proportional to finger proximity. Thus the key will repeat faster as the finger is pressed on the surface harder or a larger part of the fingertip touches the surface. This also reduces the chance that the user will cause more repeats than intended since as finger proximity begins to drop during liftoff the repeat interval becomes much longer. Decision diamond 808 checks whether the dynamic repeat interval since the last typematic symbol send has elapsed, and if necessary sends the symbol again in 810 and updates the typematic send time stamp 812.

It is desirable to let the users rest the other fingers back onto the surface after typematic has initiated 804 and while typematic continues, but the user must do so without tapping. Decision diamond 805 causes typematic to be canceled and the typematic element deleted 778 if the user asynchronously taps another finger on the surface as if trying to hit another key. If this does not occur, decision diamond 182 will eventually cause deletion of the typematic element when its finger lifts off.

The typing recognition process described above thus allows the multi-touch surface to ergonomically emulate both the typing and hand resting capabilities of a standard mechanical keyboard. Crisp taps or impulsive presses on the surface generate key symbols as soon as the finger is released or decision diamond 792 verifies the impulse has peaked, ensuring prompt feedback to the user. Fingers intended to rest on the surface generate no keys as long as they are members of a synchronized finger press or release subset or are placed on the surface gently and remain there along with other fingers for a second or two. Once resting, fingers can be lifted and tapped or impulsively pressed on the surface to generate key symbols without having to lift other resting fingers. Typematic is initiated either by impulsively pressing and maintaining distinguishable force on a key, or by holding a finger on a key while other fingers on the hand are lifted. Glancing motions of single fingers as they tap key regions are easily tolerated since most cursor manipulation must be initiated by synchronized slides of two or more fingers.

Other embodiments of the invention will be apparent to those skilled in the art from consideration of the specification and practice of the invention disclosed herein. It is intended

60

that the specification and examples be considered as exemplary only, with a true scope and spirit of the invention being indicated by the following claims.

What is claimed is:

1. A method of processing input from a touch-sensitive surface, the method comprising:

receiving at least one proximity image representing a scan of a plurality of electrodes of the touch-sensitive surface; segmenting each proximity image into one or more pixel groups that indicate significant proximity, each pixel group representing proximity of a distinguishable hand part or other touch object on or near the touch-sensitive surface; and mathematically fitting an ellipse to at least one of the pixel groups.

2. The method of claim 1 further comprising transmitting one or more ellipse parameters as a control signal to an electronic or electromechanical device.

3. The method of claim 2 wherein the one or more ellipse parameters is selected from the group consisting of position, shape, size, orientation, eccentricity, major radius, minor radius, and any combination thereof.

4. The method of claim 3 wherein the one or more ellipse parameters are used to distinguish a pixel group associated with a fingertip from a pixel group associated with a thumb.

5. The method of claim 1 wherein fitting an ellipse to a group of pixels comprises computing one or more eigenvalues and one or more eigenvectors of a covariance matrix associated with the pixel group.

6. The method of claim 1 further comprising: tracking a path of at least one of the one or more pixel groups through a time-sequenced series of proximity images;

fitting an ellipse to the at least one of the one or more pixel groups in each of the time-sequenced series of proximity images; and

tracking a change in one or more ellipse parameters through the time-sequenced series of proximity images.

7. The method of claim 6 further comprising transmitting the change in the one or more ellipse parameters as a control signal to an electronic or electromechanical device.

8. The method of claim 7 wherein the change in the one or more ellipse parameters is selected from the group consisting of position, shape, size, orientation, eccentricity, major radius, minor radius, and any combination thereof.

9. The method of claim 6 wherein fitting an ellipse to the one pixel group comprises computing one or more eigenvalues and one or more eigenvectors of a covariance matrix associated with the pixel group.

10. A touch-sensing device comprising:

a substrate;

a plurality of touch-sensing electrodes arranged on the substrate;

electronic scanning hardware adapted to read the plurality of touch-sensing electrodes;

a calibration module operatively coupled to the electronic scanning hardware and adapted to construct a proximity image having a plurality of pixels corresponding to the touch-sensing electrodes; and

a contact tracking and identification module adapted to: segment the proximity image into one or more pixel groups, each pixel group representing proximity of a distinguishable hand part or other touch object on or near the touch-sensitive surface;

and

mathematically fit an ellipse to at least one of the one or more pixel groups.

61

11. The touch-sensing device of claim 10 further comprising a host communication interface adapted to transmit one or more ellipse parameters as a control signal to an electronic or electromechanical device.

12. The touch-sensing device of claim 11 wherein the touch-sensing device is integral with the electronic or electromechanical device.

13. The touch-sensing device of claim 11 wherein the one or more ellipse parameters comprise one or more parameters selected from the group consisting of position, shape, size, orientation, eccentricity, major radius, minor radius, and any combination thereof.

14. The method of claim 13 wherein the one or more ellipse parameters are used to distinguish a pixel group associated with a fingertip from a pixel group associated with a thumb.

15. The touch-sensing device of claim 10 wherein the contact tracking and identification module is adapted to compute one or more eigenvalues and one or more eigenvectors to fit the ellipse.

16. The touch-sensing device of claim 10 wherein the contact tracking and identification module is further adapted to:

- track a path of one or more pixel groups through a plurality of time-sequenced proximity images;
- fit an ellipse to at least one of the one or more pixel groups in a first proximity image of the plurality of time-sequenced proximity images; and
- track a change in one or more ellipse parameters associated with the fitted ellipse through two or more of the time-sequenced proximity images.

17. The touch-sensing device of claim 16 further comprising a host communication interface adapted to transmit the change in at least one of the one or more ellipse parameters as a control signal to an electronic or electromechanical device.

18. The touch-sensing device of claim 17 wherein the touch-sensing device is integral with the electronic or electromechanical device.

19. The touch-sensing device of claim 17 wherein the change in one or more ellipse parameters used as a control input to an electronic or electromechanical device comprises one or more parameters selected from the group consisting of position, shape, size, orientation, eccentricity, major radius, minor radius, and any combination thereof.

20. The touch-sensing device of claim 16 wherein the contact tracking and identification module is adapted to compute one or more eigenvalues and one or more eigenvectors to fit the ellipse.

21. The touch-sensing device of any one of claims 10-12 and 16-18 wherein the touch-sensing device is fabricated on or integrated with a display device.

22. The touch-sensing device of claim 21, wherein the display device comprises a liquid crystal display (LCD) or a light-emitting polymer display (LPD).

62

23. A computer-readable medium having embodied thereon instructions executable by a machine to perform a method according to any of claims 1-9.

24. A touch-sensing device comprising:

- means for producing a proximity image representing a scan of a plurality of electrodes of a touch-sensitive surface, the proximity image having a plurality of pixels corresponding to the touch-sensing electrodes; and
- means for segmenting the proximity image into one or more pixel groups, each pixel group representing a touch object on or near the touch-sensitive surface; and
- means for fitting an ellipse to at least one of the pixel groups.

25. The touch-sensing device of claim 24 wherein the touch object comprises at least a portion of a hand.

26. The touch-sensing device of claim 24 wherein the touch object comprises at least a portion of one or more fingers.

27. The touch-sensing device of claim 24 wherein the touch object comprises at least a portion of a body part.

28. The touch-sensing device of claim 27 wherein the body part comprises one or more of a hand, a finger, an ear, or a cheek.

29. The touch-sensing device of claim 24 further comprising means for transmitting one or more ellipse parameters as a control signal to an electronic or electromechanical device.

30. The touch-sensing device of claim 27 wherein the touch-sensing device is integral with the electronic or electromechanical device.

31. The touch-sensing device of claim 24 further comprising:

- means for tracking a path of one or more pixel groups through a plurality of time-sequenced proximity images;
- means for fitting an ellipse to at least one of the pixel groups in a plurality successive proximity images; and
- means for tracking a change in one or more ellipse parameters through a plurality of time-sequenced proximity images.

32. The touch-sensing device of claim 29 further comprising means for transmitting the change in the one or more ellipse parameters as a control signal to an electronic or electromechanical device.

33. The touch-sensing device of claim 32 wherein the touch-sensing device is integral with the electronic or electromechanical device.

34. The touch-sensing device of any one of claims 24 and 29-33 wherein the touch-sensing device is fabricated on or integrated with a display device.

35. The touch-sensing device of claim 34, wherein the display device comprises a liquid crystal display (LCD) or a light-emitting polymer display (LPD).

* * * * *

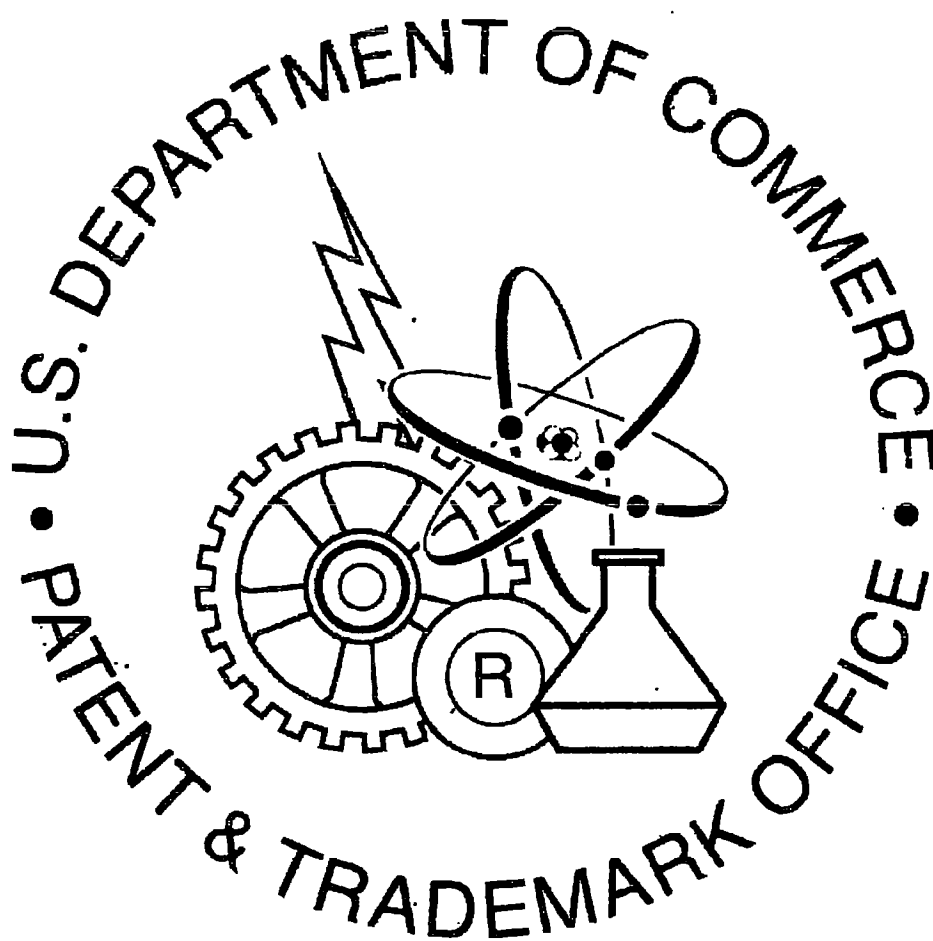

PTO-1683
(Rev. 7-96)

750 Apple 000145

A648

JX-003.085

CERTIFICATE OF SERVICE

I hereby certify that on this 20th day of July 2012, the nonconfidential version of the Opening Brief of Appellant Apple Inc. was filed with the court using CM/ECF which will automatically serve the following counsel who are registered for CM/ECF:

Megan Michele Valentine
Attorney Advisor
International Trade Commission
Suite 707-K
500 E Street, S.W.
Washington, DC 20436
megan.valentine@usitc.gov

Andrea C. Casson
International Trade Commission
Office of the General Counsel
Suite 707-D
500 E Street, S.W.
Washington, DC 20436
andrea.casson@usitc.gov

Counsel for Appellee International Trade Commission

Edward J. DeFranco
Quinn Emanuel Urquhart & Sullivan, LLP
51 Madison Avenue
22nd Floor
New York, NY 10010-1601
eddefranco@quinnemanuel.com

David A. Nelson
Quinn Emanuel Urquhart & Sullivan, LLP
500 West Madison Street
Chicago, IL 60661
davenelson@quinnemanuel.com

Matthew A. Traupman
Quinn Emanuel Urquhart & Sullivan, LLP
51 Madison Avenue
22nd Floor
New York, NY 10010-1601
matthewtraupman@quinnemanuel.com

Counsel for Intervenor Motorola Mobility, Inc.

I further certify that the following counsel were served via email:

James M. Lyons, Esq.
International Trade Commission
Office of the General Counsel
Suite 707
500 E Street, S.W.
Washington, DC 20436
jim.lyons@usitc.gov

Counsel for Appellee International Trade Commission

Charles K. Verhoeven
Quinn Emanuel Urquhart & Sullivan, LLP
22nd Floor
50 California Street
San Francisco, CA 94111
charlesverhoeven@quinnemanuel.com

Counsel for Intervenor Motorola Mobility, Inc.

/s/ E. Joshua Rosenkranz
Attorney for Appellant

**CERTIFICATE OF COMPLIANCE
UNDER FEDERAL RULES OF APPELLATE PROCEDURE
32(a)(7) AND FEDERAL CIRCUIT RULE 32**

Counsel for Plaintiff-Appellant Apple Inc. certifies that the brief contained herein has a proportionally spaced 14-point typeface, and contains 13,959 words, based on the “Word Count” feature of Word 2007, including footnotes and endnotes. Pursuant to Federal Rule of Appellate Procedure 32(a)(7)(B)(iii) and Federal Circuit Rule 32(b), this word count does not include the words contained in the Certificate of Interest, Table of Contents, Table of Authorities, and Statement of Related Cases.

Dated: July 20, 2012

Respectfully submitted,

/s/ E. Joshua Rosenkranz
Attorney for Appellant