

# **EXHIBIT A-2**

## IN THE UNITED STATES PATENT AND TRADEMARK OFFICE

Request for <i>Ex Parte</i> Reexamination	§	
	§	
U.S. Patent No. 7,469,381	§	REQUEST FOR <i>EX PARTE</i>
	§	REEXAMINATION
Issued: December 23, 2008	§	
	§	
For: LIST SCROLLING AND	§	
DOCUMENT TRANSLATION,		
SCALING, AND ROTATION ON		
A TOUCH-SCREEN DISPLAY		

Mail Stop *Ex Parte* Reexam  
 Commissioner for Patents  
 P.O. Box 1450  
 Alexandria, Virginia 22313-1450

Sir:

Pursuant to 35 U.S.C. §§ 302-307 and C.F.R. § 1.510, the undersigned hereby requests *ex parte* reexamination of Claims 1-20 of U.S. Patent No. 7,469,381 (“the ‘381 Patent,” submitted as Exhibit 1) titled “List Scrolling and Document Translation, Scaling, and Rotation on a Touch-Screen Display.” Apple Inc. is the assignee named on the face of the ‘381 Patent. The application for the ‘381 Patent was filed on December 14, 2007 and claimed priority to a series of provisional patent applications, the earliest of which were filed on January 7, 2007. The ‘381 Patent underwent reexamination and an *Ex Parte* Reexamination Certificate issued on April 26, 2011 confirming the patentability of the above claims. In the January 13, 2011 Notice of Intent to Issue the certificate, the U.S. Patent and Trademark Office found these claims to be patentable because of the presence of certain features not taught or suggested in the art of record. As set forth in detail in this request, these features are present in the new prior art references cited herein which were not previously considered by the Examiner and which raise substantial new questions of patentability, warranting another *ex parte* reexamination of all of the above claims.

U.S. Patent No. 7,469,381  
 Issued: December 23, 2008

## TABLE OF CONTENTS

	<u>Page</u>
I. INTRODUCTION .....	2
II. DESCRIPTION OF THE '381 PATENT AND THE CLAIMS FOR WHICH REEXAMINATION IS REQUESTED .....	6
A. The Specification .....	6
B. The Claims .....	11
1. The Independent Claims .....	11
2. The Dependent Claims.....	13
C. The Prosecution History .....	15
III. STATEMENT OF THE LAW .....	18
IV. PROPOSED REJECTIONS.....	20
V. STATEMENT OF SUBSTANTIAL NEW QUESTION OF PATENTABILITY .....	21
VI. DETAILED EXPLANATION OF THE PERTINENCE AND MANNER OF APPLYING THE PRIOR ART TO THE CLAIMS OF THE '381 PATENT .....	23
A. Claims 1-14, 16, 19 and 20 of the '381 Patent should be rejected under 35 U.S.C. § 102(b) as anticipated by <i>Lira</i> .....	23
1. Claims 1, 19 and 20 should be rejected as anticipated by <i>Lira</i> .....	26
2. Claim 2 should be rejected as anticipated by <i>Lira</i> .....	37
3. Claim 3 should be rejected as anticipated by <i>Lira</i> .....	37
4. Claim 4 should be rejected as anticipated by <i>Lira</i> .....	37
5. Claim 5 should be rejected as anticipated by <i>Lira</i> .....	38
6. Claim 6 should be rejected as anticipated by <i>Lira</i> .....	38
7. Claim 7 should be rejected as anticipated by <i>Lira</i> .....	38
8. Claim 8 should be rejected as anticipated by <i>Lira</i> .....	39
9. Claim 9 should be rejected as anticipated by <i>Lira</i> .....	39

U.S. Patent No. 7,469,381  
 Issued: December 23, 2008

10.	Claim 10 should be rejected as anticipated by <i>Lira</i> .....	40
11.	Claim 11 should be rejected as anticipated by <i>Lira</i> .....	41
12.	Claim 12 should be rejected as anticipated by <i>Lira</i> .....	41
13.	Claim 13 should be rejected as anticipated by <i>Lira</i> .....	41
14.	Claim 14 should be rejected as anticipated by <i>Lira</i> .....	42
15.	Claim 16 should be rejected as anticipated by <i>Lira</i> .....	42
B.	Claims 7, 13-15, 17 and 18 of the '381 Patent should be rejected under 35 U.S.C. § 103 as rendered obvious by <i>Lira</i> .....	43
1.	Claim 7 should be rejected as rendered obvious by <i>Lira</i> .....	43
2.	Claim 13 should be rejected as rendered obvious by <i>Lira</i> .....	45
3.	Claim 14 should be rejected as rendered obvious by <i>Lira</i> .....	45
4.	Claim 15 should be rejected as rendered obvious by <i>Lira</i> .....	46
5.	Claim 17 should be rejected as rendered obvious by <i>Lira</i> .....	47
6.	Claim 18 should be rejected as rendered obvious by <i>Lira</i> .....	50
C.	Claims 15, 17 and 18 should be rejected under 35 U.S.C. § 103 as rendered obvious by <i>Lira</i> in view of <i>Van Den Hoven</i> .....	52
1.	Claim 15 should be rejected as rendered obvious by <i>Lira</i> in view of <i>Van Den Hoven</i> .....	53
2.	Claim 17 should be rejected as rendered obvious by <i>Lira</i> in view of <i>Van Den Hoven</i> .....	54
3.	Claim 18 should be rejected as rendered obvious by <i>Lira</i> in view of <i>Van Den Hoven</i> .....	58
D.	Claims 1-5, 7-13 and 15-20 of the '381 Patent should be rejected under 35 U.S.C. § 102(e) as anticipated by <i>Ording</i> .....	61
1.	Claims 1, 19 and 20 should be rejected as anticipated by <i>Ording</i> .....	63
2.	Claim 2 should be rejected as anticipated by <i>Ording</i> .....	76
3.	Claim 3 should be rejected as anticipated by <i>Ording</i> .....	76
4.	Claim 4 should be rejected as anticipated by <i>Ording</i> .....	76

U.S. Patent No. 7,469,381  
Issued: December 23, 2008

5.	Claim 5 should be rejected as anticipated by <i>Ordning</i> .....	77
6.	Claim 7 should be rejected as anticipated by <i>Ordning</i> .....	77
7.	Claim 8 should be rejected as anticipated by <i>Ordning</i> .....	77
8.	Claim 9 should be rejected as anticipated by <i>Ordning</i> .....	78
9.	Claim 10 should be rejected as anticipated by <i>Ordning</i> .....	78
10.	Claim 11 should be rejected as anticipated by <i>Ordning</i> .....	78
11.	Claim 12 should be rejected as anticipated by <i>Ordning</i> .....	79
12.	Claim 13 should be rejected as anticipated by <i>Ordning</i> .....	79
13.	Claim 15 should be rejected as anticipated by <i>Ordning</i> .....	80
14.	Claim 16 should be rejected as anticipated by <i>Ordning</i> .....	81
15.	Claim 17 should be rejected as anticipated by <i>Ordning</i> .....	82
16.	Claim 18 should be rejected as anticipated by <i>Ordning</i> .....	84
VII.	CONCLUSION.....	85

U.S. Patent No. 7,469,381  
Issued: December 23, 2008

## I. INTRODUCTION

In support of this Request for Reexamination (“the Request”), requestor provides the following:

- Pursuant to 37 C.F.R. § 1.510(a), payment for the filing fee for this Request. The Director is authorized to charge TWO THOUSAND FIVE HUNDRED TWENTY DOLLARS (\$2,520.00) for the filing fee for this Request pursuant to 37 C.F.R. § 1.20(c)(1), and any additional fees, if any, in connection with the filing of this Request, to Deposit Account No. 02-4467. Any refund should be credited to the same deposit account;
- Pursuant to 37 C.F.R. § 1.510(b)(1), a statement pointing out each substantial new question of patentability based on prior patents and printed publications. *See* Section V of this Request;
- Pursuant to 37 C.F.R. § 1.510(b)(2), an identification of every claim for which reexamination is requested (*see* Section II.B of this Request), and a detailed explanation of the pertinency and manner of applying the cited prior art to every claim for which reexamination is requested (*see* Section VI of this Request, along with the detailed claims chart submitted as Exhibit 6);
- Pursuant to 37 C.F.R. § 1.510(b)(3), a copy of every patent or printed publication relied upon or referred to in the above-identified statement of substantial new questions of patentability and detailed explanation. *See* Exhibits 3-5. None of these references are non-English language patents or printed publications. These references are listed below (*Infra* at 3-4) and on form SB/08, which is submitted as Exhibit 2;

U.S. Patent No. 7,469,381  
Issued: December 23, 2008

- Pursuant to 37 C.F.R. § 1.510(b)(4), a copy of the entire '381 Patent including the front face, drawings, specification/claims (in double column format), as well as a certificate of correction and a reexamination certificate. *See* Exhibit 1. No disclaimer issued in the '381 Patent; and
- Pursuant to 37 C.F.R. § 1.510(b)(5), a certification that a copy of the Request has been served in its entirety on the patent owner at the address as provided for in 37 C.F.R. § 1.33(c). *Infra* at 87.

As mentioned above, the application for the '381 Patent - namely U.S. patent application no. 11/956,969 - was filed on December 14, 2007, and claims priority to several provisional patent applications, the earliest of which - namely U.S. patent applications nos. 60/879,253 and 60/883,801 - were filed on January 7, 2007. Accordingly, the earliest possible priority date and effective filing date for the '381 Patent is January 7, 2007. Reexamination is respectfully requested in view of the following patents and published patent applications, each of which is prior art to the '381 Patent for the reasons set forth below. These references were not considered by the Examiner<sup>1</sup> and raise substantial new questions of patentability with respect to claims for which this reexamination is requested.

1. PCT Publication No. WO 03/081458 by Luigi Lira ("*Lira*,") a copy of which is submitted as Exhibit 3. *Lira* is a PCT patent application that was published on October 2, 2003, more than one year before the January 7, 2007 earliest possible effective filing date for the '381 Patent. Therefore, *Lira* is prior art to the '381 Patent under 35 U.S.C. § 102(b). *Lira* was not cited nor considered by the Examiner during the prosecution or reexamination of the '381 Patent;
2. U.S. Patent No. 7,786,975 by Bas Ording, Scott Forstall, Greg Christie, Stephen O. Lemay and Imran Chaudhri ("*Ording*,") a copy of which is submitted as Exhibit 4. *Ording* is a U.S. patent that issued on a U.S. application that was filed on December 23, 2005, long before the January 7, 2007 earliest possible priority

---

<sup>1</sup> These references were not of record, and their teachings were not applied, in the prosecution or reexamination files of the '381 Patent.

U.S. Patent No. 7,469,381  
Issued: December 23, 2008

date for the '381 Patent. Therefore, *Ording* is prior art to the '381 Patent under 35 U.S.C. § 102(e). *Ording* was not cited nor considered by the Examiner during the prosecution or reexamination of the '381 Patent; and

3. PCT Publication No. WO 01/029702 by Elise A. W. H. Van Den Hoven and Josephus H. Eggen ("*Van Den Hoven*,") a copy of which is submitted as Exhibit 5. *Van Den Hoven* is a PCT patent application that was published on April 26, 2001, more than one year before the January 7, 2007 earliest possible effective filing date for the '381 Patent. Therefore, *Van Den Hoven* is prior art to the '381 Patent under 35 U.S.C. § 102(b). *Van Den Hoven* was not cited nor considered by the Examiner during the prosecution or reexamination of the '381 Patent.

As discussed in greater detail below, the alleged invention described and claimed in the '381 Patent is simple and straightforward. Broadly speaking, it relates to the scrolling and translating of electronic documents displayed on handheld devices with touch screen displays. In particular, the '381 Patent describes displaying an area beyond the edge of the document if an edge of the document is reached while translating the document in a first direction, so long as an object (*e.g.*, a user's finger or a stylus pen) is detected on or near the touch screen display. It also describes translating the document in a second (*e.g.*, reverse) direction until the area beyond the edge is no longer displayed when the object is no longer detected (*e.g.*, once a gesture is complete). '381 Patent, abstract, col. 1:45-48, col. 20:31-37, col. 21:22-25, col. 23:64-65, col. 24:1-4.

It is respectfully submitted that there is nothing new or novel described or claimed in the '381 Patent. Indeed, this type of electronic document manipulation on handheld devices to display an area beyond the edge and translate the document until the area beyond the edge is no longer displayed is expressly described in several prior art patents and printed publications, such as the following references, as discussed in more detail below.

One such prior art patent is *Lira*, which discloses an electronic device for browsing an electronic document (*e.g.*, a web page having structured elements such as columns) through a



U.S. Patent No. 7,469,381  
Issued: December 23, 2008

display screen having a small field-of-view window. Using a finger or stylus pen, a user can scroll/translate back and forth to view different portions of the page. *Lira* discloses several ways to align the display screen with structures in the document. One such mechanism “snaps” the edge of the display screen to the edge of a structure in the document when a panning operation ends (for example, when a user lifts her finger off a touch-screen display). This “snap” feature ensures that, when panning through a large document on the screen, the display remains properly aligned with the data in that document. This way, if the user moves the screen away from the column being read (while translating the document), an area beyond the edge of the column/document will be displayed. After detecting that an object is no longer on the display (e.g., the pen has been lifted from the screen), the document is translated in another direction such that the area beyond the edge of the page is no longer displayed, and a new portion of the page is displayed instead. *Lira*, p. 1, ln. 28-p. 2, ln. 3; pp. 14-15.

Another prior art patent which discloses the above features is *Ording*. *Ording* generally relates to the scrolling of lists (i.e., electronic documents) on handheld devices with touch-sensitive displays. At the most basic level, *Ording* translates a displayed list in response to the user’s contact and movement on the touch screen. The user’s movement on the touch screen determines the corresponding first scroll/translation direction. For example, to scroll the list, the user issues a downward stroke (i.e., a movement) on the touch screen display with a finger (i.e., object), and the displayed information items change until the edge is reached, in which case an area beyond the edge of the electronic document is displayed. *Ording* discloses the reversal of the scroll direction at an endpoint of the displayed list as it contacts and “bounces” off a virtual boundary, defined as the terminus. As the first item in the list approaches the terminus, the displayed list may bounce off the virtual boundary and reverse direction. In response to the user

U.S. Patent No. 7,469,381  
Issued: December 23, 2008

breaking contact with the touch screen (*i.e.*, removing the object so that it is no longer detected on the display), the document is free to scroll in the opposite direction (*i.e.*, translate in a second direction). The area beyond the edge will decrease in size as the first item reaches the top of the display, until it disappears and a new portion of the page is displayed instead. *Ording*, col. 1:18-20; col. 1:50-54; col. 4:1-6; col. 4:44-59; col. 7:44-49; col. 9:25-27.

Thus, it is clear that each one of the foregoing references discloses translating an electronic document in a first direction, displaying an area beyond the edge of the document, and translating the document in a second direction in response to detecting that an object is no longer on the touch screen display, until the area beyond the edge of the electronic document is no longer shown and a new portion of the electronic document is displayed.

## **II. DESCRIPTION OF THE '381 PATENT AND THE CLAIMS FOR WHICH REEXAMINATION IS REQUESTED**

The '381 Patent generally relates to the scrolling and translating of electronic documents and lists displayed on devices with touch-screen displays. It describes displaying and translating electronic documents (including lists) that a user scrolls through on touch screen displays of handheld devices. In particular, the '381 Patent describes displaying an area beyond the edge of the document if an edge of the document is reached while translating the document in a first direction, so long as an object (*e.g.*, a user's finger) is detected on or near the touch screen display. It also describes translating the document in a second direction until the area beyond the edge is no longer displayed when the object is no longer detected on or near the touch screen display. '381 Patent, abstract, col. 1:45-48; col. 23:64-65; col. 24:1-4.

### **A. The Specification**

According to the '381 Patent, the alleged invention reduces or eliminates supposed deficiencies in the prior art user interfaces for handheld devices that resorted to the addition of

U.S. Patent No. 7,469,381  
Issued: December 23, 2008

push buttons and complex menu systems. '381 Patent, col. 1:62-67. Specifically, the patent purports to address a problem in these prior art systems wherein the scrolling of lists and the translating, rotating, scaling of electronic documents on the small-size display screens of portable devices could not be easily accommodated. '381 Patent, col. 2:14-18.

The '381 Patent describes interactions with the user interface primarily through finger contacts and gestures on the touch-sensitive display. '381 Patent, col. 2:47-50. User input to the touch-sensitive display is accomplished using a touch-sensitive surface that detects haptic and/or tactile contact (including movement and breaking of the contact) from the user and converts the detected contact into interaction with one or more displayed user interface objects (*e.g.*, soft keys, icons, web pages). '381 Patent, col. 12:30-40. Software components determine if a contact occurred, determine and track the movement of a contact, and determine the breaking of a contact on the touch-sensitive display system. '381 Patent, col. 15:6-15.

In response to detecting the movement of an object (*e.g.*, a user's finger) on or near the touch-sensitive display, a displayed list or electronic document may be respectively scrolled or translated. '381 Patent, col. 20:31-37. In response to the detection of a virtual boundary such as the edge of an electronic document (or the terminus of a list), the direction of scrolling or translation may be reversed. '381 Patent, col. 21:22-25. Although the '381 Patent discusses list scrolling and electronic document translation separately, list scrolling can be considered as a particular example of electronic document scrolling since, as suggested by the '381 Patent, electronic document scrolling can be characterized as a two-dimensional version of list scrolling. '381 Patent, col. 26:56-58.

U.S. Patent No. 7,469,381  
 Issued: December 23, 2008

## List Scrolling

The list scrolling operation moves the contents of the displayed list across the screen along a single dimension. '381 Patent, col. 26:56-57. A list has two endpoints each identified as a terminus (*i.e.*, an edge) of the list. According to the '381 Patent, in response to detecting the movement of an object detected on or near a touch screen display of a device, a list of items (*e.g.*, emails, instant message conversations, phone numbers, contact information, album names) displayed on the touch screen is scrolled in a first direction (*e.g.*, horizontally or vertically). '381 Patent, col. 24:1-18. If the terminus of the list (*e.g.*, either the first or last item in the list) is reached while scrolling in the first direction, and the object is still detected on or near the touch screen display, an area beyond the terminus of the list is displayed. '381 Patent, col. 24:19-32. The area beyond the terminus may be white or visually indistinct from the background of the list. '381 Patent, col. 24:28-32. When the object is no longer detected, the list is scrolled in a second direction opposite the first, until the area beyond the terminus is no longer displayed. '381 Patent, col. 24:33-36. Figure 6C is a visual depiction of the area the beyond the terminus of the list being displayed on the touch-sensitive display.

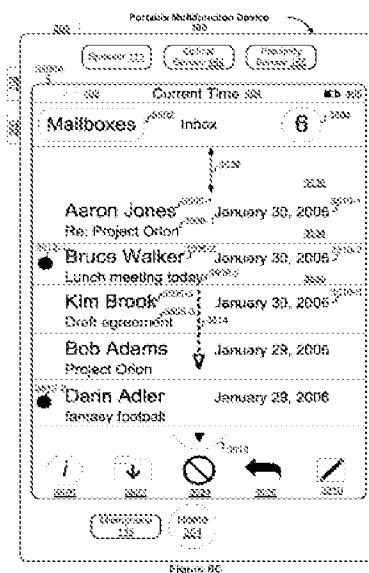

U.S. Patent No. 7,469,381  
Issued: December 23, 2008

### **Electronic Document Translation**

Whereas list scrolling is disclosed to occur along a single dimension, the '381 Patent also discusses a similar type of scrolling for electronic documents; one in which documents are scrolled along two dimensions. '381 Patent, col. 26:56-58. Just as list scrolling allows a user to view the un-displayed content of a list that is too large to fit on the display screen, an electronic document can be translated (*i.e.*, scrolled) to allow a user to view an electronic document to large for the physical display area. '381 Patent, col. 26:58-62. Examples of electronic documents include a web page, digital image, spreadsheet, email, word processing document. '381 Patent, col. 27:5-12. Much like the termini or edges of a list, electronic documents also have edges. '381 Patent, col. 26:65-67.

According to the '381 Patent, in response to detecting the movement of a of an object (*e.g.*, a user's finger) on or near a touch screen display of a device, an electronic document displayed on the touch screen is scrolled in a first direction (*e.g.*, horizontally, vertically, or diagonally). '381 Patent, abstract, col. 23:64-65. Upon reaching the edge of the document, while scrolling in the first direction and while the object is still detected on or near the touch screen display, an area beyond the edge of the document is displayed. '381 Patent, abstract, col. 27:25-30. The area beyond the edge of the document may be a solid color (*e.g.*, black, white, gray) or otherwise visually distinct from the document itself. '381 Patent, col. 27:30-36. When the object is no longer detected, the electronic document is translated in a second direction until the area beyond the edge of the document is no longer displayed. '381 Patent, abstract, col. 27:40-43. The second direction for electronic document translation may be opposite the first direction. '381 Patent, col. 27:45-47. Thus, after scrolling in the second direction some portion of the electronic document is displayed.

U.S. Patent No. 7,469,381  
 Issued: December 23, 2008

Figure 8C is a visual depiction of the area the beyond the edge of the electronic document being displayed on the touch-sensitive display.

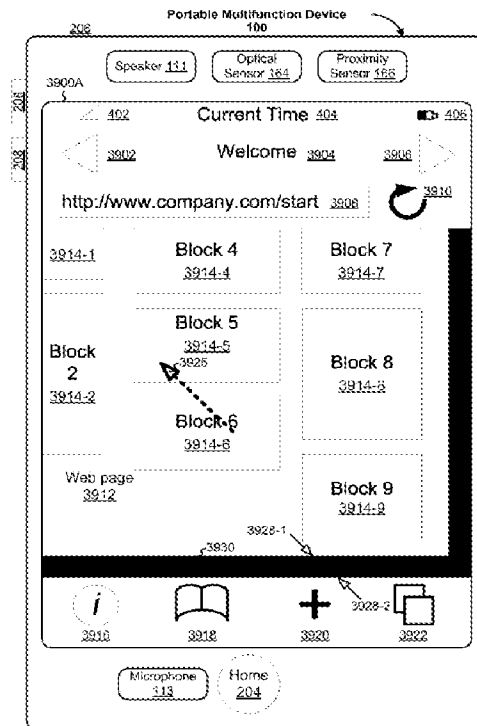

Figure 8C

The '381 Patent also discusses how the scrolling or translation in the second direction may give the appearance of an elastic attachment corresponding to the simulation of an elastic ball striking an inelastic object and such apparent motion can be damped by the inclusion of a friction term. '381 Patent, col. 21:26-43; col. 24:38-44; col. 27:48-55.

Scrolling or translating may be accelerated in response to an accelerated movement of the detected object. '381 Patent, col. 20:40. An example of such accelerated movement is a swipe or sweep gesture. '381 Patent, col. 20:52-67. The '381 Patent also discusses using the speed of the detected input movement to determine the associated speed of list scrolling or electronic document translation. '381 Patent, col. 24:61-67, col. 27:18-20. Also discussed is correlating the distance of translation or scrolling with the distance traveled by the object on or near the touch-sensitive display. '381 Patent, col. 24:45-52, col. 27:60-64.

U.S. Patent No. 7,469,381  
 Issued: December 23, 2008

## **B. The Claims**

The '381 Patent includes 20 claims, three of which (claims 1, 19, and 20) are independent, and seventeen of which (claims 2-18) are dependent.

### **1. The Independent Claims**

The independent claims are very similar, and generally require the following common elements: (1) a device with a touch screen display; (2) displaying a first portion of an electronic document; (3) detecting the movement of an object on or near the touch screen display, and in response, displaying a second portion of the document; (4) displaying an area beyond the edge of the document along with a third portion of the document in response to an edge of the document being reached while translating the document; and (5) translating the document in a second direction until the area beyond the edge of the document is no longer displayed in response to detecting that the object is no longer on or near the touch screen display, such that a fourth portion of the document is displayed. The following chart sets forth each limitation of claims 1, 19, and 20, with analogous claim limitations appearing in the same row:

Claim 1	Claim 19	Claim 20
A computer-implemented method, comprising:	A device, comprising:	A computer readable storage medium having stored therein instructions, which when executed by a device with a touch screen display, cause the device to:
(a) at a device with a touch screen display:	(a) a touch screen display;	

U.S. Patent No. 7,469,381  
 Issued: December 23, 2008

Claim 1	Claim 19	Claim 20
	(b) one or more processors; (c) memory; (d) and one or more programs, wherein the one or more programs are stored in the memory and configured to be executed by the one or more processors, the programs including:	
(b) displaying a first portion of an electronic document;	(e) instructions for displaying a first portion of an electronic document;	(a) display a first portion of an electronic document;
(c) detecting a movement of an object on or near the touch screen display; in response to detecting the movement, translating the electronic document displayed on the touch screen display in a first direction to display a second portion of the electronic document, wherein the second portion is different from the first portion;	(f) instructions for detecting a movement of an object on or near the touch screen display; instructions for translating the electronic document displayed on the touch screen display in a first direction to display a second portion of the electronic document, wherein the second portion is different from the first portion, in response to detecting the movement;	(b) detect a movement of an object on or near the touch screen display; translate the electronic document displayed on the touch screen display in a first direction to display a second portion of the electronic document, wherein the second portion is different from the first portion, in response to detecting the movement;
(d) in response to an edge of the electronic document being reached while translating the electronic document in the first direction while the object is still detected on or near the touch screen display: displaying an area beyond the edge of the document, and displaying a third portion of the electronic document, wherein the third portion is smaller than the first portion; and	(g) instructions for displaying an area beyond an edge of the electronic document and displaying a third portion of the electronic document, wherein the third portion is smaller than the first portion, in response to the edge of the electronic document being reached while translating the electronic document in the first direction while the object is still detected on or near the touch screen display; and	(c) display an area beyond an edge of the electronic document and display a third portion of the electronic document, wherein the third portion is smaller than the first portion, if the edge of the electronic document is reached while translating the electronic document in the first direction while the object is still detected on or near the touch screen display; and



U.S. Patent No. 7,469,381  
 Issued: December 23, 2008

Claim 1	Claim 19	Claim 20
(e) in response to detecting that the object is no longer on or near the touch screen display, translating the electronic document in a second direction until the area beyond the edge of the electronic document is no longer displayed to display a fourth portion of the electronic document, wherein the fourth portion is different from the first portion.	(h) instructions for translating the electronic document in a second direction until the area beyond the edge of the electronic document is no longer displayed to display a fourth portion of the electronic document, wherein the fourth portion is different from the first portion, in response to detecting that the object is no longer on or near the touch screen display.	(d) translate the electronic document in a second direction until the area beyond the edge of the electronic document is no longer displayed to display a fourth portion of the electronic document, wherein the fourth portion is different from the first portion, in response to detecting that the object is no longer on or near the touch screen display.

## 2. The Dependent Claims

Dependent claims 2-18 of the '381 Patent all depend from independent claim 1, and are reproduced as follows:

2. The computer-implemented method of claim 1, wherein the first portion of the electronic document, the second portion of the electronic document, the third portion of the electronic document, and the fourth portion of the electronic document are displayed at the same magnification.

3. The computer-implemented method of claim 1, wherein the movement of the object is on the touch screen display.

4. The computer-implemented method of claim 1, wherein the object is a finger.

5. The computer-implemented method of claim 1, wherein the first direction is a vertical direction, a horizontal direction, or a diagonal direction.

6. The computer-implemented method of claim 1, wherein the electronic document is a web page.

U.S. Patent No. 7,469,381  
Issued: December 23, 2008

7. The computer-implemented method of claim 1, wherein the electronic document is a digital image.

8. The computer-implemented method of claim 1, wherein the electronic document is a word processing, spreadsheet, email or presentation document.

9. The computer-implemented method of claim 1, wherein the electronic document includes a list of items.

10. The computer-implemented method of claim 1, wherein the second direction is opposite the first direction.

11. The computer-implemented method of claim 1, wherein translating in the first direction prior to reaching an edge of the document has an associated speed of translation that corresponds to a speed of movement of the object.

12. The computer-implemented method of claim 1, wherein translating in the first direction is in accordance with a simulation of an equation of motion having friction.

13. The computer-implemented method of claim 1, wherein the area beyond the edge of the document is black, gray, a solid color, or white.

14. The computer-implemented method of claim 1, wherein the area beyond the edge of the document is visually distinct from the document.

15. The computer-implemented method of claim 1, wherein translating the document in the second direction is a damped motion.

U.S. Patent No. 7,469,381  
Issued: December 23, 2008

16. The computer-implemented method of claim 1, wherein changing from translating in the first direction to translating in the second direction until the area beyond the edge of the document is no longer displayed makes the edge of the electronic document appear to be elastically attached to an edge of the touch screen display or to an edge displayed on the touch screen display.

17. The computer-implemented method of claim 1, wherein translating in the first direction prior to reaching the edge of the electronic document has a first associated translating distance that corresponds to a distance of movement of the object prior to reaching the edge of the electronic document; and wherein displaying an area beyond the edge of the electronic document comprises translating the electronic document in the first direction for a second associated translating distance, wherein the second associated translating distance is less than a distance of movement of the object after reaching the edge of the electronic document.

18. The computer-implemented method of claim 1, wherein translating in the first direction prior to reaching the edge of the electronic document has a first associated translating speed that corresponds to a speed of movement of the object, and wherein displaying an area beyond the edge of the electronic document comprises translating the electronic document in the first direction at a second associated translating speed, wherein the second associated translating speed is slower than the first associated translating speed.

### **C. The Prosecution History**

Application No. 11/956,969 was filed along with a Petition to Make Special Under Accelerated Examination Procedure on December 14, 2007. It contained 20 claims.

U.S. Patent No. 7,469,381  
Issued: December 23, 2008

On February 28, 2008, the U.S. Patent and Trademark Office (PTO) dismissed the Petition to Make Special citing the Applicant's search terms and the resulting narrowness of the search as the reason for dismissal. In response to the dismissal, Applicant filed on March 13, 2008 a Request for Reconsideration along with a revised Pre-Examination search statement which included the supplemental search terms required by the PTO. According to the Applicant, the supplemental search did not reveal any additional relevant references. Applicant's Petition to Make Special was granted on April 17, 2008. In the Applicant's Supplemental Accelerated Examination Support Document filed on April 30, 2008, Applicant cited U.S. Patent 6,690,387 to Zimmerman *et al.* ("Zimmerman"), U.S. Patent 5,495,566 to Kwatinetz *et al.* ("Kwatinetz"), U.S. Patent Application Publication 2005/0012723 ("Pallakoff") and D. Miller, *Personal Java Application Environment*, (1999) ("Miller") as the references most closely related to the subject matter claimed in the Application.

On June 2, 2008, the PTO Examiner conducted an interview with the Applicant during which the parties discussed Zimmerman, a collection of Microsoft Word screenshots and U.S. Patent Application Publication 2008/0104544 ("Collins"). At the interview, Applicant agreed to amend the last limitation of each of the independent claims to read "in response to detecting that the object is no longer on or near the touch screen display, translating the document in a second direction until the area beyond the edge of the document is no longer displayed." The agreed to amendment was to replace the following language "after the object is no longer detected" phrasing used in the independent claims of the original application with the phrasing "in response to detecting that the object."

During a second interview on June 30, 2008, the Applicant and Examiner again discussed the Zimmerman reference along with Photo Mesa screenshots and U.S. Patent Application

U.S. Patent No. 7,469,381  
Issued: December 23, 2008

Publication 2004/0027398 (“Jaeger”). To distinguish over the cited prior art, Applicant proposed to make further amendments to the claims. During a third interview on August 4, 2008, Applicant’s proposed amended claims were discussed with the Examiner along with the Photo Mesa and Jaeger references. The Examiner conceded that the proposed amended claims were patentable over the cited prior art, and agreed to enter the changes by an Examiner’s amendment. The Examiner’s amendment mainly added four displayed portions of the electronic document at various stages of the process recited in each independent claim.

A Notice of Allowance issued on October 29, 2008, in which the Examiner’s amendments and reasons for allowance were detailed. In particular, the Examiner’s reasons for allowance stated that the prior art failed to teach: 1) in response to an edge of the document being reached while translating the document in a first direction, displaying an area beyond the edge of the document along with a third portion of the document that is smaller than the first portion; and 2) in response to no longer detecting the object, translating the document in a second direction until the area beyond the edge is no longer displayed, and displaying a fourth portion of the electronic document that is distinct from the first portion. The ‘381 Patent subsequently issued on December 23, 2008.

On April 28, 2010, a Request for *Ex Parte* Reexamination was filed at the PTO in connection with the ‘381 Patent. On July 14, 2010, the PTO issued a Decision Granting *Ex Parte* Reexamination finding that the references cited in the request raised a substantial new question of patentability with respect to all claims of the ‘381 Patent. The Request for *Ex Parte* Reexamination cited the following references as the basis for the substantial new question of patentability: Forlines *et al.*, *Glimpse: A Novel Input Model for Multi-Level Devices*, (2005) (“Glimpse”), Millhollon *et al.*, *Microsoft Office Word 2003 Inside Out*, (2003) (“Inside Out”),

U.S. Patent No. 7,469,381  
Issued: December 23, 2008

U.S. Patent Application Publication 2005/0195154 (“Robbins”) and Zimmerman. The Decision stated that although Zimmerman was previously cited, it had not been considered in combination with the new prior art, namely, Glimpse, Inside and Robbins which were submitted with the reexamination request.

On January 13, 2011, the PTO issued a Notice of Intent to Issue *Ex Parte* Reexamination Certificate confirming the patentability of claims 1-20 of the ‘381 Patent. The Examiner found that, while the prior art (*e.g.*, Inside Out) discloses displaying an area beyond the edge of the document, none of the Glimpse, Inside Out, Robbins or Zimmerman references taught or suggested the following: “in response to detecting that the object is no longer on or near the touch screen display, translating the electronic document in a second direction until the area beyond the edge of the electronic document is no longer displayed to display a fourth portion of the electronic document wherein the fourth portion is different than the first portion.”

Thus, the Examiner allowed the claims of the ‘381 Patent because the prior art of record did not disclose the required feature of: translating the document in a second direction, in response to detecting that the object is no longer on or near the touch screen display, until the area beyond the edge is no longer displayed (thereby displaying a portion of the document that is different than the one displayed at first). This is the alleged point of novelty for the ‘381 Patent.

### **III. STATEMENT OF THE LAW**

The Federal Circuit has clearly stated that, during a reexamination proceeding: (1) there is no presumption of validity; and (2) patent claims are interpreted with the broadest reasonable interpretation. *See In re American Academy Of Science Tech. Center*, 367 F.3d 1359, 1364, 70 USPQ2d 1827 (Fed. Cir. 2004); *Ethicon, Inc. v. Quigg*, 849 F.2d 1422, 1427 (Fed. Cir. 1988); *In re Yamamoto*, 740 F.2d 1569, 1571, 222 USPQ 934, 936 (Fed. Cir. 1984). Construing patent claims broadly during reexamination is not unfair to the patentee because the patentee has the

U.S. Patent No. 7,469,381  
Issued: December 23, 2008

opportunity to amend its patent claims to obtain more precise claim coverage. *See, e.g., In re American Academy Of Science Tech. Center*, 367 F.3d at 1364; *In re Yamamoto*, 740 F.2d at 1571.

A single prior art reference anticipates the claimed invention under 35 U.S.C. § 102 when the reference discloses, either expressly or under the principles of inherency, all of the elements of the claimed invention. *See Akamai Tech., Inc. v. Cable & Wireless Internet Serv., Inc.*, 344 F.3d 1186, 1194-95, 68 USPQ2d 1186 (Fed. Cir. 2003) (reversing jury verdict of patent validity and infringement, and holding patent claim invalid for anticipation based on, *inter alia*, inherent teachings of the prior art); *In re Schreiber*, 128 F.3d 1473, 1477-79, 44 USPQ2d 1429, 1431 (Fed. Cir. 1997) (affirming Board of Patent Appeals and Interferences' sustaining a final rejection based on anticipation and inherent teachings of the prior art), rehearing denied, suggestion for rehearing en banc declined (1997); and *In re Samour*, 571 F.2d 559, 563-64, 197 USPQ 1, 4 (CCPA 1978) (upholding that a rejection for anticipation relying upon on a single, primary prior art reference can also rely upon additional references to show that the claimed subject matter, every material element of which is disclosed in the primary prior art reference, was in possession of the public), rehearing denied (1978).

Two or more prior art references invalidate the claimed invention under 35 U.S.C. § 103 when the combined teachings of the references make obvious the elements of the claimed invention to a person of ordinary skill in the art. *See KSR Int'l Co. v. Teleflex Inc.*, 127 S. Ct. 1727, 1740 (2007) ("If a person of ordinary skill can implement a predictable variation, § 103 likely bars its patentability."). A single prior art reference can also invalidate the claimed invention under 35 U.S.C. § 103 based on obviousness. *See KSR Int'l Co.*, 127 S.Ct. at 1744-1746 (finding a patent claim invalid based on obviousness given that a person of ordinary skill in

U.S. Patent No. 7,469,381  
Issued: December 23, 2008

the art could have modified the teaching of a reference in a fashion encompassed by the claim, and would have seen the benefits of doing so); *Sibia Neurosciences Inc. v. Cadus Pharmaceutical Corp.*, 255 F.3d 1349, 55 USPQ2d 1927, 1931-33 (Fed. Cir. 2000) (reversing the district court's denial of JMOL motion on the issue of invalidity following the rejection by the jury of the invalidity defense based on obviousness and finding that it would have been obvious to modify a single prior art reference to arrive at the claimed invention). *See also Ruiz v. A.B. Chance Co.*, 357 F.3d 1270, 1276-77, 69 USPQ2d 1686 (Fed. Cir. 2004); and *McNeil-PPC, Inc. v. L. Perrigo Co.*, 337 F.3d 1362, 1368-71, 67 USPQ2d 1649 (Fed. Cir. 2003) (affirming invalidity of patent claims based on obviousness) *cert. denied L. Perrigo Co. v. McNeil-PPC, Inc.*, 124 S.Ct. 1061 (2004).

Finally, various rationales such as the following can result in the claimed invention being obvious under 35 U.S.C. § 103: combining or substituting various claimed elements known in the prior art according to known methods to yield a predictable result; using a known technique to improve a similar device in the same way; choosing from a finite number of identified, predictable solutions with a reasonable expectation of success or, in other words, the solution was one which was "obvious to try"; a known work in one field of endeavor prompting variations of it for use either in the same field or a different field based on given design incentives or other market forces in which the variations were predictable to one of ordinary skill in the art; and/or a teaching, suggestion, or motivation in the prior art that would have led one of ordinary skill in the art to modify the prior art reference or to combine the teachings of various prior art references to arrive at the claimed invention. *See KSR Int'l Co.*, 127 S.Ct. at 1739-1742.

#### **IV. PROPOSED REJECTIONS**

This Request for Reexamination of the '381 Patent, claims 1-20, provides the basis for the following proposed rejections:



U.S. Patent No. 7,469,381  
Issued: December 23, 2008

1. Claims 1-14, 16, 19 and 20 of the '381 Patent should be rejected under 35 U.S.C. § 102(b) as anticipated by *Lira*;
2. Claims 7, 13-15, 17 and 18 of the '381 Patent should be rejected under 35 U.S.C. § 103 as rendered obvious by *Lira*;
3. Claims 15, 17 and 18 should be rejected under 35 U.S.C. § 103 as rendered obvious by *Lira* in view of *Van Den Hoven*; and
4. Claims 1-5, 7-13 and 15-20 of the '381 Patent should be rejected under 35 U.S.C. § 102(e) as anticipated by *Ording*.

#### **V. STATEMENT OF SUBSTANTIAL NEW QUESTION OF PATENTABILITY**

As discussed above in Section II. C of this Request, the Examiner allowed the claims of the '381 Patent because the prior art considered did not expressly disclose the claimed feature of: translating an electronic document in a second direction, in response to detecting that an object is no longer on or near the touch screen display, until an area beyond the edge is no longer displayed (thereby displaying a portion of the document that is different than the one displayed at first). This is the alleged point of novelty for the '381 Patent. *See* January 13, 2011 Notice of Intent to Issue *Ex Parte* Reexamination Certificate, at 5.

As explained more fully below, *Lira* (which was not cited during prosecution or reexamination) provides a new technological teaching not considered by the Examiner in the prior examination by disclosing the feature cited by the Examiner as apparently missing from the prior art, namely, in response to detecting that the object is no longer on or near the touch screen display, translating the electronic document in a second direction until the area beyond the edge of the electronic document is no longer displayed to display a fourth portion that is different from the first displayed portion of the electronic document. *Infra* at 32-36 discussing, e.g., how *Lira* teaches limitations 1(d)-(e). Specifically, *Lira* discloses a “snap-to” feature in which a “vertical

U.S. Patent No. 7,469,381  
Issued: December 23, 2008

alignment control” aligns a display window to an edge of an electronic document such as a web page (*i.e.*, translating the document in a second direction) after detecting that a pen (*i.e.*, object) has been lifted from the screen. This causes a previously-displayed area beyond the edge of the document to no longer be displayed, and a new portion of the page to be displayed (which is different from a previously displayed portion as a result of the user’s scrolling through the page). *Lira*, p. 15, lns. 18-31; Figure 14B. Thus, *Lira* presents a substantial new question of patentability.

Similarly, as explained more fully below, *Ording* (which was not cited during prosecution or reexamination) provides a new technological teaching not considered by the Examiner in the prior examination by disclosing the feature cited by the Examiner as apparently missing from the prior art, namely, in response to detecting that the object is no longer on or near the touch screen display, translating the electronic document in a second direction until the area beyond the edge of the electronic document is no longer displayed to display a fourth portion that is different from the first displayed portion of the electronic document. *Infra* at 70-75 discussing, e.g., how *Ording* teaches limitations 1(d)-(e). Specifically, *Ording* discloses a scrolling feature in which a list (*i.e.*, electronic document) is bounced off a virtual boundary and reverses direction (*i.e.*, translating the document in a second direction) after detecting that the user’s finger (*i.e.*, object) has been lifted from the screen. This causes a previously-displayed area beyond the edge of the document to no longer be displayed, and a new portion of the list to be displayed (which is different from a previously displayed portion as a result of the user’s scrolling through the list). *Ording*, col. 8:22-53, col. 9:25-27, col. 6:50-65; Figures 6 and 7A-C. Thus, *Ording* presents a substantial new question of patentability.

U.S. Patent No. 7,469,381  
Issued: December 23, 2008

**VI. DETAILED EXPLANATION OF THE PERTINENCE AND MANNER OF APPLYING THE PRIOR ART TO THE CLAIMS OF THE '381 PATENT**

**A. Claims 1-14, 16, 19 and 20 of the '381 Patent should be rejected under 35 U.S.C. § 102(b) as anticipated by *Lira***

As discussed above, *Lira* is a PCT patent application that was published on October 2, 2003, more than one year before the January 7, 2007 earliest possible effective filing date for the '381 Patent, and is therefore prior art to the '381 Patent under 35 U.S.C. § 102(b). Moreover, *Lira* was not cited nor considered by the Examiner during the prosecution or reexamination of the '381 Patent. *Supra* at 3.

*Lira* discloses an electronic device for browsing an electronic document. *Lira* at p. 1, ln. 28-p. 2, ln. 3. As explained in *Lira* and illustrated in Figure 2, a display screen can be thought of as a small field-of-view window over a large image or electronic document. The electronic document may be a web page with structured elements such as columns. *Lira* discloses several ways for a display screen to pan through the web page (*e.g.*, item 100) whose size exceeds the size of the display screen. *Lira* shows a display window (item 200) superimposed onto the larger web page 100, where the user scrolls back and forth (indicated by arrows of potential scrolling directions) to view different areas of the page.

U.S. Patent No. 7,469,381  
 Issued: December 23, 2008

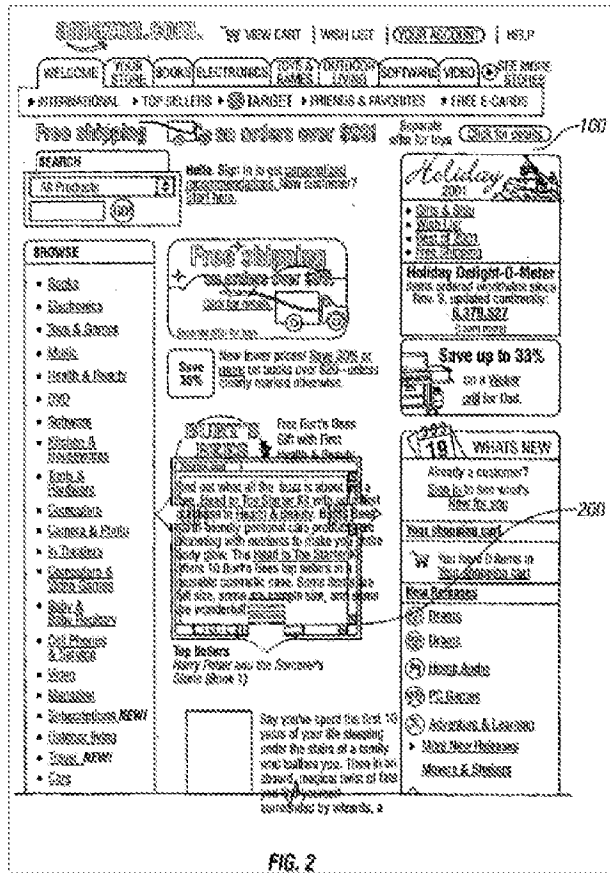

*Lira* discloses scrolling through this web page by illustrating the position over time of one browser window performing a panning operation. In Figure 10, *Lira* illustrates a horizontal scrolling operation by showing multiple display windows that represent the path of a single window scrolling horizontally through the web page. Figure 12 likewise illustrates scrolling this window in horizontal, vertical, or diagonal directions using a stylus.

Figure 14B shows a path along which the user moves her input tool to pan the display window through portions of the underlying web page. This series of windows in Figure 14B depicts the positions over time of a single window 1205 as the window vertically scrolls through the underlying web page 1210.

U.S. Patent No. 7,469,381  
 Issued: December 23, 2008

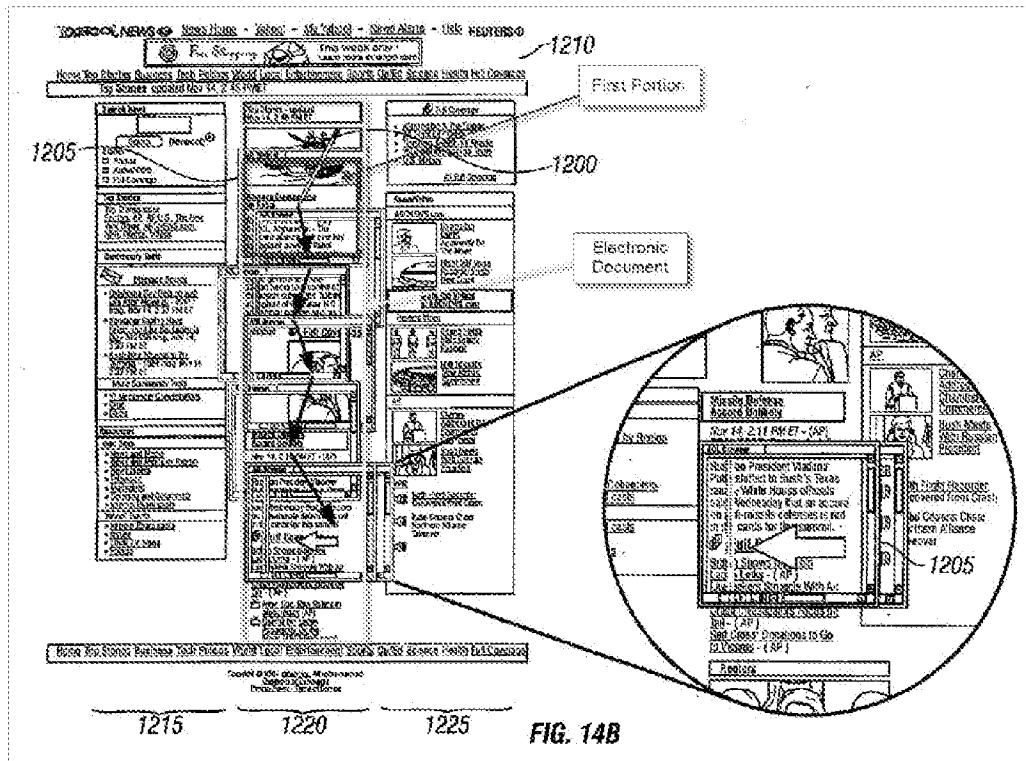

As shown in the annotated figure, the logical column 1220 is an electronic document which has boundaries. *Lira*, p. 15, lns. 25-29 (logical columns 1215, 1220 and 1225 are likewise each electronic documents which are sub-documents in a larger web page). Any one of the areas within window 1205 of the logical column 1220 is a portion of the electronic document which is displayed as the user scrolls through the document. An exemplary first portion is shown in an annotated fashion in the figure above.

*Lira* discloses several ways for the panning to utilize structures in the document in order to align the display screen with structures in the document. One such mechanism is an animated “snap” feature that “snaps” the edge of the display screen to the edge of a structure in the document when a panning operation ends (for example, when a user lifts their finger off a touch-screen display). This “snap” feature is disclosed in *Lira* as one of several solutions for ensuring that a display screen panning through a large electronic document remains properly aligned with the data in the document. *See, e.g., Lira*, p. 14-15. In this mode, if the user moves the screen

U.S. Patent No. 7,469,381  
Issued: December 23, 2008

away from the column being read (while translating the document), an area beyond the edge of the column/document will be displayed.

As part of the “snap-to” feature is a “vertical alignment control” which displays window 1205 to an edge of the document (*i.e.*, translates in a second direction) after detecting that a pen (*i.e.*, object) has been lifted from the screen. This causes a previously-displayed area beyond the edge of the page to no longer be displayed, and a new portion of the page to be displayed (which is different from a previously displayed portion as a result of the user’s scrolling through the page). Figure 14B above illustrates this “snap-to” behavior.

As set forth in more detail below and in the chart attached at Exhibit 6, Part A, it is respectfully submitted that *Lira* anticipates claims 1-14,16, 19 and 20 of the ‘381 Patent.

**1. Claims 1, 19 and 20 should be rejected as anticipated by *Lira***

As explained above in Section II.B.1 (*supra* at 11-12), independent claims 1, 19, and 20 of the ‘381 Patent recite substantially similar limitations, and are therefore treated together in the section below. *Lira* discloses each and every limitation of these claims.

*Lira Discloses the Preambles of Claims 1, 19 and 20:* The preamble of claim 1 recites a “computer-implemented method,” while the preamble of claim 19 recites a “device.” The preamble of claim 20 recites a “computer readable storage medium having stored therein instructions” which are “executed by a device with a touch screen display.” *Lira* discloses these features.

*Lira* discloses “a device having a small display ... for example, a PDA.” *Lira*, p. 1, lns. 16-17. “The display may include a touch screen.” *Lira*, p. 3, ln. 10. Thus, *Lira* discloses a device with a touch screen display. The device may be one or more general purpose or special purpose, programmed computers. *Lira*, p. 18, lns. 23-30. Therefore, *Lira* discloses the device required in the claim 19 preamble. According to *Lira*, this device includes a computer “storage

U.S. Patent No. 7,469,381  
Issued: December 23, 2008

medium” where there is a “software application loaded on the client device ... for commanding and directing communications enabled by the client device.” *Lira*, p. 19, lns. 27-30. *Lira* states that “a program, a piece of code, an instruction, a device, a computer” instructs the device to operate as described. *Lira*, p. 1, 9, lns. 24-27. Thus, *Lira* discloses that the computer has a storage medium having instructions that are stored therein and that are executed by the device with a touch screen display, as required in the claim 20 preamble. Based on the foregoing, it is clear that *Lira* discloses that the resulting method by which the device operates is implemented by a computer, and thus discloses a computer-implemented method, as required in the claim 1 preamble.

Thus, *Lira* discloses the preambles of claims 1, 19 and 20. *See* Exhibit 6, Part A at 1, 26 and 28-29.

*Lira Discloses Limitations 1(a) and 19(a)*: These limitations require that the device have a “touch screen display.” As discussed above in relation to the preambles of the independent claims, *Lira* discloses this feature. *Lira* discloses “a device having a small display ... for example, a PDA.” *Lira*, p. 1, lns. 16-17. “The display may include a touch screen.” *Lira*, p. 3, ln. 10. *See* Exhibit 6, Part A at 1 and 26-27.

*Lira Discloses Limitations 19(b)-(d)*: These limitations require that the device include “one or more processors,” “memory” and “one or more programs, wherein the one or more programs are stored in the memory and configured to be executed by the one or more processors”. *Lira* discloses these features.

*Lira* makes clear that the (client) device includes one or more processors such as “one or more general-purposes computers... special purpose computers” or a combination thereof. *Lira*, p. 18, lns. 23-30. *Lira* also makes clear that the (client) device includes memory such as a

U.S. Patent No. 7,469,381  
Issued: December 23, 2008

“storage medium.” *Lira*, p. 19, lns. 27-30. As discussed above in relation to the preambles of the independent claims (*supra* at 26-27), *Lira* also discloses one or more programs in the form of software, code and/or instructions stored in memory and configured to be executed by the device processor(s).

*Lira* also discloses that the one or more programs are stored in the memory and configured to be executed by the one or more processors. For example, *Lira* discloses a “storage medium” where there is a “software application loaded on the client device ... for commanding and directing communications enabled by the client device.” *Lira*, p. 19, lns. 27-30. *Lira* states that “a program, a piece of code, an instruction” instructs the device (including the processor(s) to operate as described. *Lira*, p. 19, lns. 24-27.

Thus, *Lira* discloses limitations 19(b)-(d). See Exhibit 6, Part A at 26-27.

*Lira Discloses Limitations 1(b), 19(e) and 20(a)*: These limitations require displaying “a first portion of an electronic document.” *Lira* discloses this feature.

*Lira* discloses an electronic device for browsing an electronic document. As illustrated in *Lira* and explained further below in connection with Figures 2 and 14, a display screen can be thought of as a small field-of-view window over a large image or electronic document. *Lira*, p. 1, ln. 16-p. 2, ln. 3.

*Lira* illustrates the steps of scrolling through an electronic document in its figures. Much like in the ‘381 Patent (*See, e.g.*, col. 27:5-12), an example of an electronic document that a user may view through the device is a web page. *Lira*, Figure 2, item 100. Web page 100 in *Lira* is an electronic document that is too large to display in its entirety on the relatively small screen of a device such as a PDA. Instead, only a portion of the web page can be readably displayed in the PDA’s browser window at any given time. This is illustrated in Figure 2 by a display window



U.S. Patent No. 7,469,381  
 Issued: December 23, 2008

superimposed onto the web page. *Lira*, Figure 2, item 200. Since web page 100 is larger than display window 200, the user must scroll back and forth along two dimensions (as indicated in Figure 2 by arrows that show potential scrolling directions) to view different areas of the web page.

As part of that browsing of an electronic document, *Lira* will display a first portion of an electronic document. This is illustrated in Figure 14B of *Lira*. More specifically, Figure 14B shows a path along which the user moves an input tool (e.g., stylus pen) to pan display window 1205 through portions of the underlying web page. *Lira*, p. 14, lns. 18-28; p. 15, lns. 18-19. This series of windows in Figure 14B depicts the positions over time of a single window as the window vertically scrolls through an underlying web page.

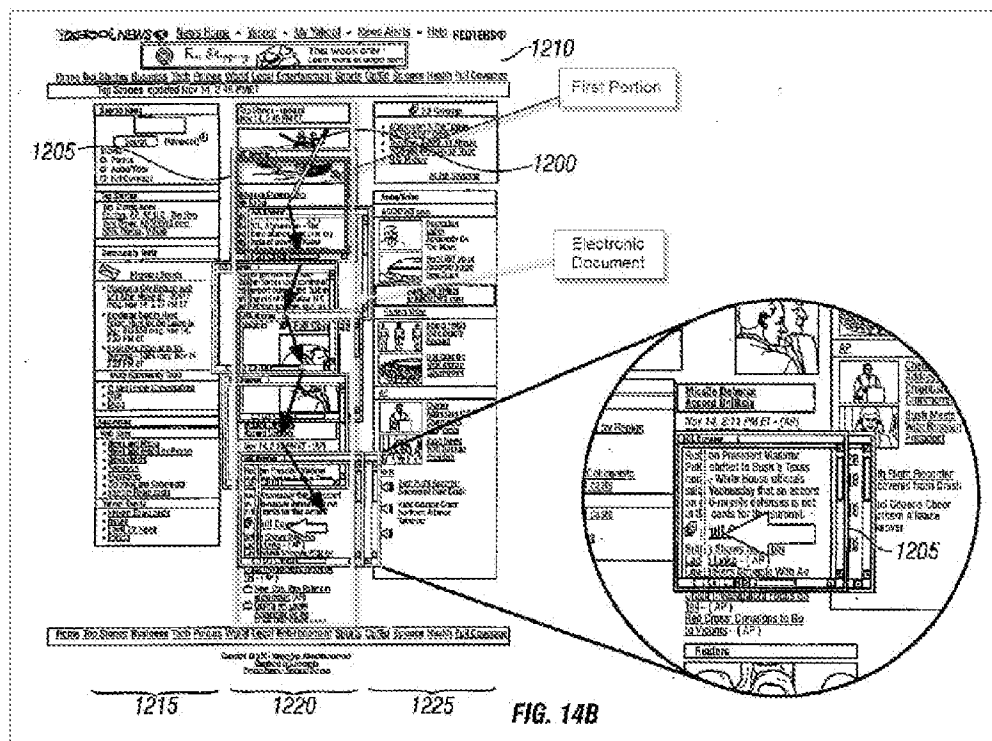

As shown in the annotated figure, the logical column 1220 is an electronic document. For example, this logical column 1220 has boundaries. *Lira*, p. 15, lns. 25-29. Logical columns 1215 and 1225 are likewise each electronic documents. All of these logical columns 1215,

U.S. Patent No. 7,469,381  
Issued: December 23, 2008

1220, and 1225 are sub-documents in a larger electronic document: the web page. Each of these sub-documents is displayed on the display screen.

Figure 14B illustrates several different portions of the electronic document 1220 being displayed in the display window over time. Any one of these displayed areas of the logical column 1220 is a *portion* of that electronic document. Accordingly, an example of a first portion of an electronic document 1220 displayed by *Lira* is the portion highlighted in the above figure. *Lira* therefore discloses displaying a first portion of an electronic document.

Thus, *Lira* discloses limitations 1(b), 19(e) and 20(a). See Exhibit 6, Part A at 1-8, 27 and 29.

*Lira Discloses Limitations 1(c), 19(f) and 20(b)*: These limitations require detecting “a movement of an object on or near the touch screen display,” and “in response to detecting the movement,” translating the electronic document “in a first direction to display a second portion of the electronic document.” These limitations further require that the second portion be different from the first portion. *Lira* discloses these features.

*Lira* discloses detecting a movement of an object - namely, a stylus (which, is an example of an object disclosed in the ‘381 Patent (*see, e.g.*, col. 12:66-col. 13:1)) - on the touch screen display. *Lira* further discloses translating the electronic document in a first direction in response to detecting the movement. For example, *Lira* discloses “touch-and-drag” scrolling, where the user can “scroll the display window by placing a stylus 600 on the display window 605 and then dragging the stylus 600.” *Lira*, p. 11, lns. 27-29. *Lira* discloses detecting such movement based on “tracking the motion of the input tool on the touch screen.” *Lira*, p. 3, lns. 1-14.

As the user drags the display window to scroll in a first direction (*see* the general downward direction in which the filled arrows below point), the electronic document is

U.S. Patent No. 7,469,381  
 Issued: December 23, 2008

translated in the display so that a second portion of the electronic document that is different than the first portion of the electronic document will be displayed, as illustrated in Figure 14B.

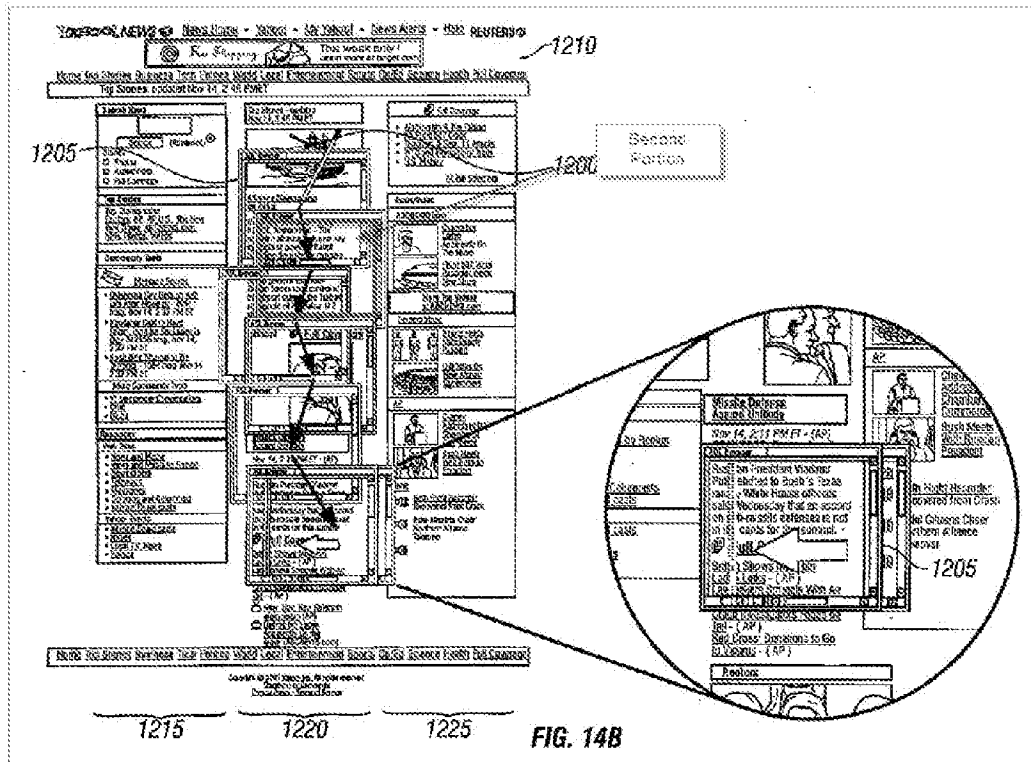

An example of a second portion of the electronic document 1220 displayed by *Lira* is the portion highlighted in the above annotated figure. This second portion differs from the first portion due to the difference between the contents shown in the display area within the second highlighted portion in the figure above, and the contents shown in the display area within the first highlighted portion in the in the same figure depicted in the discussion of limitations 1(b), 19(e) and 20(a).

The foregoing demonstrates that *Lira* discloses detecting a movement of an object on the touch screen display and, in response, translating the electronic document to display a second portion of the electronic document that is different from the first portion.

U.S. Patent No. 7,469,381  
Issued: December 23, 2008

Thus, *Lira* discloses limitations 1(c), 19(f) and 20(b). *See* Exhibit 6, Part A at 8-10, 27 and 29.

*Lira Discloses Limitations 1(d), 19(g) and 20(c)*: These limitations require that “in response to an edge of the electronic document being reached while translating the electronic document in the first direction while the object is still detected on or near the touch screen display,” displaying “an area beyond the edge of the document” and “a third portion of the electronic document.”. These limitations further require that the third portion be “smaller than the first portion.” *Lira* discloses these features.

*Lira* discloses in response to an edge of the electronic document being reached (while translating the document in the first direction and while the object is still detected on the touch screen): displaying an area beyond the edge of the document. For example, in one mode described in *Lira*, the user moves the screen away from the column being read (thus translating the document given that the column is an electronic document as explained in the discussion above pertaining to limitations 1(b), 19(e) and 20(a) (*supra* at 28-30)). In this mode, if the user moves the screen away from the column being read (while translating the document), an area beyond the edge of the column/document will be displayed.

More specifically, *Lira* discloses “vertical alignment control” which will align the display window to an edge of the electronic document. In one embodiment, “the vertical alignment control is enabled when the user lifts the pen 1200 from the display 1205,” which causes the column “to snap into alignment with the display window as the user stops scrolling.” *Lira*, p. 15, Ins. 18-31. Thus, before the user lifts the pen, the translation will remain while the object/pen is still detected on the touch screen. In addition, an area beyond the edge will be displayed under these conditions when the edge of the document is reached.

U.S. Patent No. 7,469,381  
 Issued: December 23, 2008

Figure 14B illustrates this “snap-to” behavior, including the conditions that trigger this “snap” behavior. As shown and highlighted in the annotated figure, the display window is displaying an exemplary area beyond the edge of the logical column 1220. Specifically, the display window 1205 is displaying an area of logical column 1220 and also displaying an area of logical column 1225 (a separate electronic document).

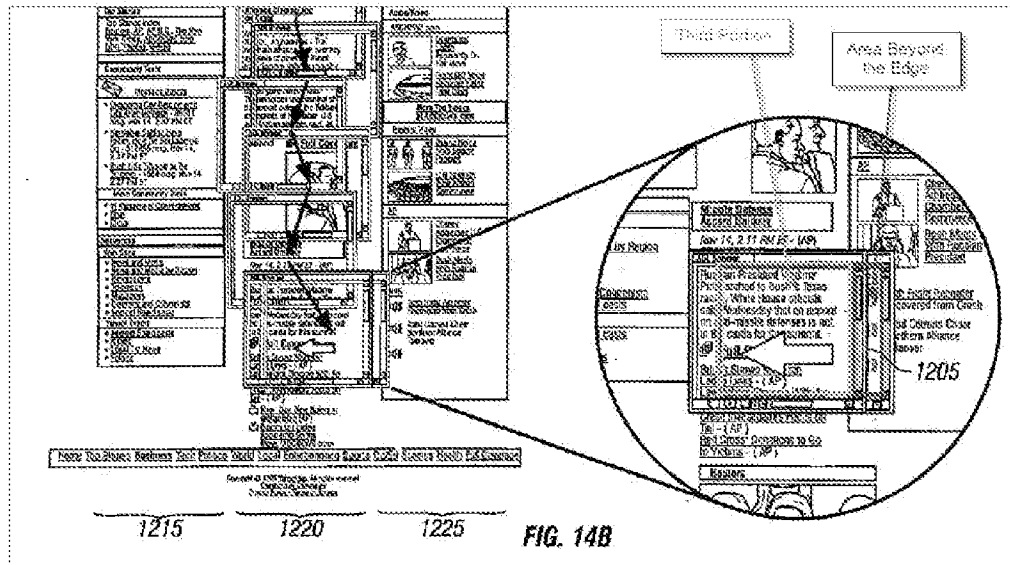

This same behavior is part of the continuation of the act of scrolling down the page described in the previous limitations. As the user continues to scroll the display window (e.g., at an angle to true vertical as depicted above) down over the column and reaching an edge of the document, the area beyond the edge of the document is displayed as depicted in the figure above.<sup>2</sup>

<sup>2</sup> It is worth noting that an “edge” of an electronic document may be *internal*. In fact, at least one Federal Court construed the term “edge of an electronic document” as being “not limited to ‘external’ edges” and stated that “[a]n ‘edge’ of an electronic document may be internal.” See pp. 17-19 and 23 of April 4, 2012 Order Construing Disputed Claim Terms issued by the Federal District Court for the Northern District of California in *Apple Inc. v. Samsung Elecs. Co.*, 5:11-CV-01846-LHK, ECF No. 849 (attached hereto as Exhibit 7). An example of such an “internal” edge is the boundary of individual columns in *Lira*, such as the boundary between column 1220 and column 1225. Thus, regardless of whether individual columns (such as logical columns 1220 and 1225) within web page 1210 are considered to be separate “electronic documents”, it is

U.S. Patent No. 7,469,381  
Issued: December 23, 2008

*Lira* also discloses displaying a third portion of the electronic document that is smaller than the first portion. Continuing the example illustrated in the same figure herein, as the user continues to drag the display window beyond the edge of the logical column 1220, the display window will increasingly pan over areas of logical column 1225. When this occurs, because the display window is only devoting a portion of its display area to the display of logical column 1220, the third portion of the column 1220 being displayed is naturally smaller than the first portion of column 1220 as depicted in the figure shown in the discussion pertaining to limitations 1(b), 19(e) and 20(a).

The foregoing demonstrates that *Lira* discloses in response to an edge of the electronic document being reached while translating the electronic document in the first direction while the object is still detected on the touch screen: displaying an area beyond the edge of the document, and a third portion that is smaller than the first portion.

Thus, *Lira* discloses limitations 1(d), 19(g) and 20(c). See Exhibit 6, Part A at 10-13 and 27-29.

*Lira Discloses Limitations 1(e), 19(h) and 20(d)*: These limitations require that “in response to detecting that the object is no longer on or near the touch screen display,” translating the document “in a second direction until the area beyond the edge of the electronic document is no longer displayed to display a fourth portion of the electronic document. These limitations further require that the fourth portion be “different from the first portion.” *Lira* discloses these features.

---

clear that *Lira* discloses displaying an area beyond an “internal” edge of electronic document 1210 as depicted in Figure 14B, given that window 1205 is displaying an area of column 1220 while also displaying an area of column 1225 beyond the boundary of column 1220.

U.S. Patent No. 7,469,381  
Issued: December 23, 2008

*Lira* discloses, in response to detecting that the object is no longer on the touch screen display, translating the electronic document in a second direction until the area beyond the edge of the electronic document is no longer displayed to display a fourth portion of the electronic document. More specifically, *Lira* discloses that, in response to detecting that “the pen 1200 is lifted from the screen,” the document 1220 will “snap” into alignment (*i.e.*, it will be translated in a second direction) such that the area beyond the edge is no longer displayed. “[A]s the pen 1200 is lifted from the screen” certain actions occur depending on whether the scrolling from column 1220 to column 1225 doesn’t exceed a certain threshold. Specifically, when the user lifts the stylus or finger from the screen, “the logical column 1220 [will] snap into alignment with the display window 1205 as the user stops scrolling” by for example “snap[ping] to the nearest logical column.” *Lira*, p. 15, lns. 19-25. This action is taken as a result of an indication of “an intention to continue to view the text column 1220” and, thus, “the display 1205 centers the logical column 1210 as the pen 1200 is lifted from the screen.” *Id.*

This snap-to function moves the document in a second direction, as indicated in the arrow in Figure 14B, until the area beyond the edge of the column is no longer displayed. This will result in a fourth portion of the column 1220 being displayed, and will also result in no area of column 1225 being displayed, as can be seen from the following:

U.S. Patent No. 7,469,381  
 Issued: December 23, 2008

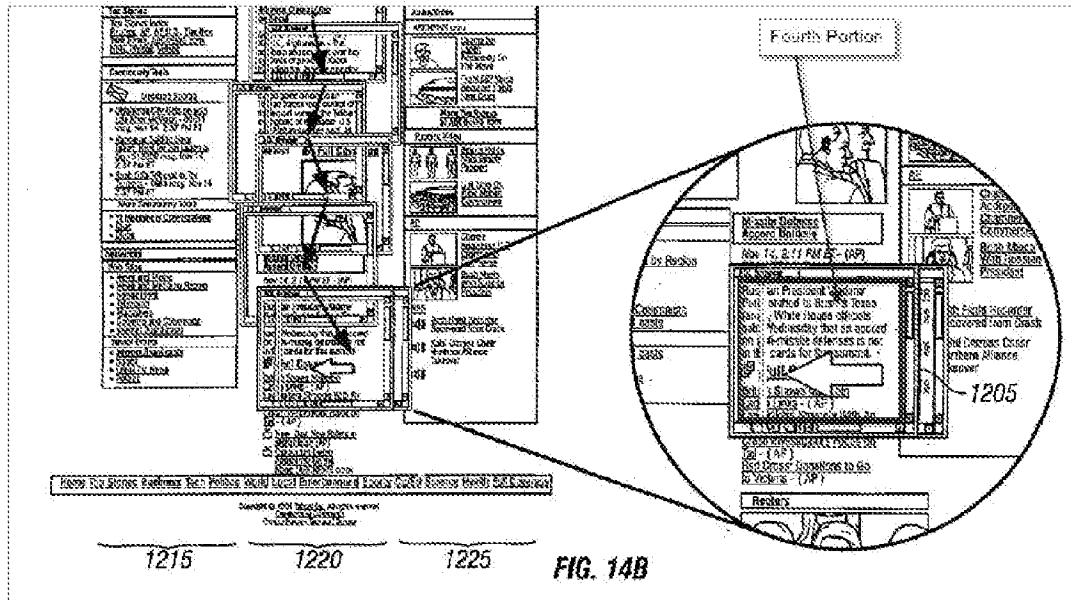

*Lira* also discloses that the fourth portion is different from the first portion. This is simply due to the fact that the user will have scrolled down through the electronic document. An example of the fourth portion of the electronic document 1220 displayed by *Lira* is the portion highlighted in the above annotated figure. As can be seen, this fourth portion differs from the first portion due to the difference between the contents shown in the display area within the fourth highlighted portion in the figure above, and the contents shown in the display area within the first highlighted portion in the same figure as depicted in the discussion of limitations 1(b), 19(e) and 20(a).

The foregoing demonstrates that *Lira* discloses that, in response to detecting that the object is no longer on the touch screen display, translating the electronic document in a second direction until the area beyond the edge of the electronic document is no longer displayed to display a fourth portion that is different from the first portion of the electronic document.

Thus, *Lira* discloses limitations 1(e), 19(h) and 20(d). See Exhibit 6, Part A at 13-15, 28 and 30.



U.S. Patent No. 7,469,381  
Issued: December 23, 2008

In view of the foregoing, *Lira* discloses each and every limitation of, and therefore anticipates, claims 1, 19 and 20.

**2. Claim 2 should be rejected as anticipated by *Lira***

Claim 2 depends from claim 1, and further requires that the first, second, third and fourth portions of the electronic document be “displayed at the same magnification.” *Lira* discloses this feature.

As Figure 14B of *Lira* illustrates, the magnification of the web page (*i.e.*, the electronic document) is not changed as the user browses through the page. Instead, the underlying web page is displayed at the same magnification as window 1205 moves to display the different first, second, third and fourth portions illustrated in the discussion above independent claim 1 (*supra* at 29, 31, 33 and 36).

Thus, *Lira* anticipates claim 2. *See* Exhibit 6, Part A at 15-16.

**3. Claim 3 should be rejected as anticipated by *Lira***

Claim 3 depends from claim 1, and further requires that the “movement of the object is on the touch screen display.” *Lira* discloses this feature.

*Lira* discloses that the touch screen input occurs in response to the user touching or pressing the touch screen display, either through a finger or a stylus pen (*i.e.*, the object). The “motion of the input tool on the touch screen” is tracked, and therefore, the movement of such an object is on the touch screen display. *Lira*, p. 3, lns. 6-14.

Thus, *Lira* anticipates claim 3. *See* Exhibit 6, Part A at 16-17.

**4. Claim 4 should be rejected as anticipated by *Lira***

Claim 4 depends from claim 1, and further requires that “the object is a finger.” *Lira* discloses this feature.

U.S. Patent No. 7,469,381  
Issued: December 23, 2008

*Lira* discloses that “the input tool may be a pen stylus or a finger.” *Lira*, p. 3, lns. 6-9.

*Lira* therefore discloses that the tool (*i.e.*, object) is a finger.

Thus, *Lira* anticipates claim 4. *See* Exhibit 6, Part A at 17.

**5. Claim 5 should be rejected as anticipated by *Lira***

Claim 5 depends from claim 1, and further requires that the “first direction is a vertical direction, a horizontal direction, or a diagonal direction.” *Lira* discloses this feature.

*Lira* discloses that the direction of scrolling (*i.e.*, the first translation direction) can be horizontal, vertical, or diagonal, such that the first direction can be any direction as shown by the arrows depicted in Figures 12 and 14B.

Thus, *Lira* anticipates claim 5. *See* Exhibit 6, Part A at 17-18.

**6. Claim 6 should be rejected as anticipated by *Lira***

Claim 6 depends from claim 1, and further requires that the “the electronic document is a web page.” *Lira* discloses this feature.

As discussed above in connection with limitation 1(b) (*supra* at 28-30), *Lira* discloses that the electronic document that the user views through the device is a web page (*e.g.*, item 100 in Figure 2 or item 1210 in Figure 14B). *Lira*, p. 2, lns. 22-23.

Thus, *Lira* anticipates claim 6. *See* Exhibit 6, Part A at 18-19.

**7. Claim 7 should be rejected as anticipated by *Lira***

Claim 7 depends from claim 1, and further requires that the “the electronic document is a digital image.” *Lira* discloses this feature.

*Lira* discloses that the electronic document includes a digital image. *See, e.g., Lira*, Figures 2, 14B (showing web pages that include images such as items 100 and 1210).

Thus, *Lira* anticipates claim 7. *See* Exhibit 6, Part A at 19-21.

U.S. Patent No. 7,469,381  
Issued: December 23, 2008

**8. Claim 8 should be rejected as anticipated by *Lira***

Claim 8 depends from claim 1, and further requires that the “electronic document is a word processing, spreadsheet, email or presentation document.” *Lira* discloses this feature.

*Lira* discloses applying the methods discussed in it to electronic documents such as a presentation document (*i.e.*, “other electronic documents ... formatted for viewing and navigation.”). *Lira*, p.1, ln. 7. *Lira* also discloses applying the methods discussed in it to electronic documents such as a “spreadsheet.” *Lira*, p.16, lns. 1-3.

Thus, *Lira* anticipates claim 8. *See* Exhibit 6, Part A at 21-22.

**9. Claim 9 should be rejected as anticipated by *Lira***

Claim 9 depends from claim 1, and further requires that the “electronic document includes a list of items.” *Lira* discloses this feature.

*Lira* discloses that the web page (*i.e.*, electronic document) may include a list of items. For example, as shown and highlighted in an annotated version of Figure 14B, the logical columns of the web page as disclosed by *Lira* include lists of items.

U.S. Patent No. 7,469,381  
 Issued: December 23, 2008

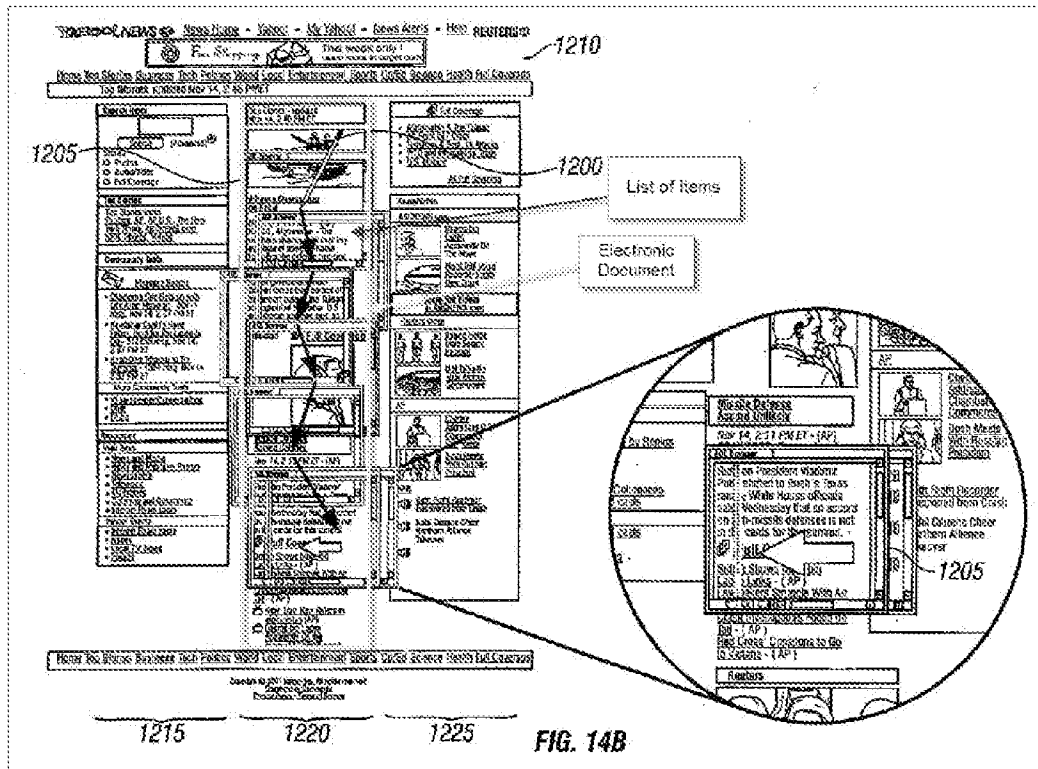

Thus, *Lira* anticipates claim 9. See Exhibit 6, Part A at 22-23.

#### 10. Claim 10 should be rejected as anticipated by *Lira*

Claim 10 depends from claim 1, and further requires that the “second direction is opposite the first direction.” *Lira* discloses this feature.

As discussed in above in connection with claim 5 (*supra* at 38), *Lira* discloses that the first direction can be horizontal, vertical, or diagonal, such that the first direction can be any direction - including the opposite direction of the “snap to” operation. The goal of *Lira*’s snap-to function is to “cause[] the logical column 1220 to snap into alignment with the display window 1205 as the user stop[s] scrolling.” *Lira*, p. 15, lns. 19-21. Accordingly, in the case where the first direction is a horizontal translation only to the right, then the second direction is opposite the first direction (*i.e.*, a horizontal translation to the left).

Thus, *Lira* anticipates claim 10. See Exhibit 6, Part A at 23-24.

U.S. Patent No. 7,469,381  
Issued: December 23, 2008

**11. Claim 11 should be rejected as anticipated by *Lira***

Claim 11 depends from claim 1, and further requires that the “translating in the first direction prior to reaching an edge of the document has an associated speed of translation that corresponds to a speed of movement of the object.” *Lira* discloses this feature.

*Lira* states that “[m]oving the page of information may include moving the page a distance equal to a change in the coordinate information of the input tool multiplied by a factor based on the acceleration or the velocity of the input tool.” *Lira*, p. 5, lns. 13-15. Thus, the speed of translation in the first direction prior to reaching the edge corresponds to a speed of movement of the input tool (*i.e.*, object).

Thus, *Lira* anticipates claim 11. *See* Exhibit 6, Part A at 24.

**12. Claim 12 should be rejected as anticipated by *Lira***

Claim 12 depends from claim 1, and further requires that the “translating in the first direction is in accordance with a simulation of an equation of motion having friction.” *Lira* discloses this feature.

*Lira* states that the “the user may select a variable velocity that begins scrolling the display slowly, picks up speed, and then slows down again as the displayed portion approaches the second view.” *Lira*, p. 14, lns 15-17. Thus, *Lira* discloses that the translation speed may be slower at the beginning and end of the translations, thus simulating friction and inherently relying on some equation to calculate this variable translation speed.

Thus, *Lira* anticipates claim 12. *See* Exhibit 6, Part A at 24.

**13. Claim 13 should be rejected as anticipated by *Lira***

Claim 13 depends from claim 1, and further requires that the “area beyond the edge of the document is black, gray, a solid color, or white.” *Lira* discloses this feature.

U.S. Patent No. 7,469,381  
Issued: December 23, 2008

The area beyond the edge will be dictated by the particular web page column (*i.e.*, document) being scrolled in *Lira*. For example, in Figure 14B, if the background of the web page is a solid color (*e.g.* white), that will be the color of the area beyond the edge of the document, given that the area beyond the edge will be a portion of the neighboring column 1225. Thus, under this example, the area beyond the edge of the column displayed is a solid color, *e.g.* white.

Thus, *Lira* anticipates claim 13. *See* Exhibit 6, Part A at 24-25.

**14. Claim 14 should be rejected as anticipated by *Lira***

Claim 14 depends from claim 1, and further requires that the “area beyond the edge of the document is visually distinct from the document.” *Lira* discloses this feature.

For example, Figure 14B of *Lira* shows the neighboring column displayed beyond the edge of the document, which is visually distinct from the document.

Thus, *Lira* anticipates claim 14. *See* Exhibit 6, Part A at 25.

**15. Claim 16 should be rejected as anticipated by *Lira***

Claim 16 depends from claim 1, and further requires that the “changing from translating in the first direction to translating in the second direction until the area beyond the edge of the document is no longer displayed makes the edge of the electronic document appear to be elastically attached to an edge of the touch screen display or to an edge displayed on the touch screen display.” *Lira* discloses this feature.

As discussed above in connection with limitations 1(d) and (e) (*supra* at 32-36), *Lira* discloses translating in the first direction, followed by translating in the second direction until the area beyond the edge of the document is no longer displayed in the form of a snap-to function. *Lira* further discloses that the snap-to function “causes the logical column 1220 to snap into alignment with the display window 1205 as the user stop scrolling.” *Lira*, p. 15, lns. 19-21.

U.S. Patent No. 7,469,381  
Issued: December 23, 2008

This snap-to-align function therefore makes the edge of the electronic document appear to be elastically attached to an edge of the touch screen display.

Thus, *Lira* anticipates claim 16. See Exhibit 6, Part A at 26.

**B. Claims 7, 13-15, 17 and 18 of the ‘381 Patent should be rejected under 35 U.S.C. § 103 as rendered obvious by *Lira***

As set forth in more detail below and in the chart attached at Exhibit 6, Part B, it is respectfully submitted that *Lira* renders obvious claims 7, 13-15, 17 and 18 of the ‘381 Patent.

**1. Claim 7 should be rejected as rendered obvious by *Lira***

Claim 7 depends from claim 1, and further requires that the “the electronic document is a digital image.” *Lira* discloses this feature as discussed above (*supra* at 38-39). However, even assuming for the sake of argument that *Lira* does not explicitly disclose applying its methods to a digital image, it would have been obvious to do so for a number of reasons. For example, it was well known in the art at the time of the invention that images could be included within a web page which is an electronic document disclosed by *Lira*. In fact, the web page shown in *Lira* includes digital images. See, e.g., *Lira*, Figures 2, 14B (showing web pages that include images such as items 100 and 1210). Accordingly, at a minimum, *Lira* explicitly discloses that its techniques apply to electronic documents that include digital images. Thus it would have been obvious to one of ordinary skill in the art to apply the teaching of *Lira* to an electronic document which is a digital image.

Moreover, the user interface features identified above as anticipating claim 1 of the ‘381 Patent operate independently of the nature of the underlying electronic document. In other words, the user can utilize these same techniques to manipulate any document displayed on the screen, regardless of whether the document is a list of items or a digital image or any other kind of electronic document. Additionally, because digital images are commonly displayed

U.S. Patent No. 7,469,381  
Issued: December 23, 2008

on computing devices, one of skill in the art would have been motivated to modify *Lira* so that its user interface features operated on digital images.

Importantly, having a digital image as an electronic document would have been a simple design choice representing a trivial and predictable variation. As the '381 Patent admits, electronic documents – including images – were well-known and commonly displayed on portable electronic devices with small screens long before the priority date of the '381 Patent, as were other document types including word processing documents, spreadsheets, and presentation documents. *See* '381 Patent col. 2: 14-23; col. 27:5-12.<sup>3</sup> Thus, it would have been obvious to one of ordinary skill in the art to apply the disclosure of *Lira* to digital images. A person of ordinary skill would have been motivated to use the techniques disclosed in *Lira* to improve navigation in any number of electronic documents, including digital images.

In addition, given that *Lira* discloses support for many well known and complex document types including web pages and their associated documents, *Lira* clearly was designed to support many document types. As a result, a person of ordinary skill in the art would view the exemplary web page described in *Lira* as interchangeable with other types of electronic documents, including digital images. Substituting one document type (such as an image) for another document type (such as a web page that includes an image) would have been nothing more than a modification yielding a predictable result based on known elements, and would be viewed as a mere design choice by one of ordinary skill.

Thus, *Lira* renders claim 7 obvious. *See* Exhibit 6, Part B at 2-6.

---

<sup>3</sup> M.P.E.P. 2217 III and 2258 I. F 1-2 state that, during reexamination, “an admission by the patent owner of record in the file or in a court record may be utilized in combination with a patent or printed publication”. “An admission as to what is in the prior art is simply that, an admission, and requires no independent proof. It is an acknowledged, declared, conceded, or recognized fact or truth”.



U.S. Patent No. 7,469,381  
Issued: December 23, 2008

**2. Claim 13 should be rejected as rendered obvious by *Lira***

Claim 13 depends from claim 1, and further requires that the “area beyond the edge of the document is black, gray, a solid color, or white.” *Lira* discloses this feature as discussed above (*supra* at 41-42). However, even assuming for the sake of argument that *Lira* does not explicitly state that the area beyond the edge of the displayed column is white, black, gray, or any other solid color, requiring that the edge of the document be a solid color or shade does not add anything of patentable significance to the alleged invention. The area beyond the edge will be dictated by the particular web page column (*i.e.*, document) being scrolled in *Lira*. For example, in Figure 14B, if the background of the web page is a solid color (*e.g.*, white), that will be the color of the area beyond the edge of the document, given that the area beyond the edge will be a portion of the neighboring column 1225. Thus, under this example, the area beyond the edge of the column displayed is a solid color, *e.g.*, white.

Nevertheless, making the area beyond the edge of the document white, black, gray, or any other solid color would have been a simple design choice for one of ordinary skill in the art. Indeed, colors were well-known in the graphic user interface art, and selecting or replacing one color for another among possible known colors for the area beyond the edge was an entirely predictable, trivial, variation. Finally, to simplify implementation and to minimize memory and processor use, a solid color can be used rather than a pattern and, therefore, it would have been obvious to one of ordinary skill in the art to make the area beyond the edge of the document any solid color.

Thus, *Lira* renders claim 13 obvious. *See* Exhibit 6, Part B at 6-7.

**3. Claim 14 should be rejected as rendered obvious by *Lira***

Claim 14 depends from claim 1, and further requires that the “area beyond the edge of the document is visually distinct from the document.” *Lira* discloses this feature as discussed above

U.S. Patent No. 7,469,381  
Issued: December 23, 2008

(*supra* at 42). However, even assuming for the sake of argument that *Lira* does not explicitly state that the area beyond the edge of the document is visually distinct from the document, requiring that the area beyond the edge of the document be visually distinct from the electronic document does not add anything of patentable significance to the alleged invention.

As discussed above in connection with claim 13 (*supra* at 45), it would have been obvious to one of ordinary skill in the art to have the area beyond the edge of the document be a solid color or shade (*e.g.*, white, black, gray, or any other solid color). Similarly, it would have been obvious to choose any one of these or other colors that has a sharp contrast from the document background to further clarify to the user that the end of the document has been reached, because an edge can be better conveyed by the application of contrast. Coloring the area beyond the edge of the document a single shade so as to display some contrast with the edge of the document would have been a simple design choice representing a trivial and predictable variation, dependent on the designer's aesthetic preference. Visual distinctions were not novel in user interfaces, and their use here would have been entirely predictable to a person of ordinary skill.

Thus, *Lira* renders claim 14 obvious. *See* Exhibit 6, Part B at 7-8.

#### **4. Claim 15 should be rejected as rendered obvious by *Lira***

Claim 15 depends from claim 1, and further requires that the “translating the document in the second direction is a damped motion.” To the extent that *Lira* does not explicitly state that the translation in the second direction is a damped motion, it would have been obvious to one of ordinary skill in the art to modify the teachings of *Lira* relating to the translation in the second direction to ensure that this particular motion is damped.

*Lira* discloses a “snap-to” function that moves the document in the second direction so that when the user lifts the stylus or finger from the screen, “the logical column 1220 [will] snap into alignment with the display window 1205 as the user stops scrolling” by for

U.S. Patent No. 7,469,381  
Issued: December 23, 2008

example “snap[ping] to the nearest logical column.” *Lira*, p. 15, lns. 19-25. Moreover, *Lira* discloses that the scrolling velocity may be varied (*e.g.*, slowed down) as the displayed portion of the document approaches a particular view. *Lira*, p. 14, lns. 15-17. Here, the “snap-to” transition is an approach to such a view. Such varying of scrolling velocities amounts to damped motion. It would have been obvious to modify the “snap-to” motion in the second direction to include such a dampening feature. One of ordinary skill in the art would have been motivated to do so in order to provide a smoother transition between the document portions as the area beyond the edge is no longer displayed, since *Lira* discloses improving readability and enabling users to get a better sense of their position in the document through scrolling animation effects. *Lira*, p. 1, lns. 10-14; p. 12, ln. 29 – p.13, ln. 13. Such an implementation would have amounted to nothing more than an application of a known technique (*e.g.*, the dampening) to another technique (*e.g.*, the snap-to function) - both of which are taught by the same reference - to achieve a predictable result.

Thus, *Lira* renders claim 15 obvious. *See* Exhibit 6, Part B at 8-9.

**5. Claim 17 should be rejected as rendered obvious by *Lira***

*Lira* Discloses the preamble of claim 17: Claim 17 depends from claim 1, and further requires that “translating in the first direction prior to reaching the edge of the electronic document has a first associated translating distance that corresponds to a distance of movement of the object prior to reaching the edge of the electronic document.” *Lira* discloses this feature.

*Lira* discloses that the page can scroll (*i.e.*, translate) an amount equal to the distance of movement of a stylus pen (*i.e.*, object). *Lira*, p. 17, lns. 5-9. *Lira* also discloses a scrolling multiplier that can change the ratio between the movement of the stylus and the amount of document translation. *Lira*, p.17, lns. 13-21. Thus, based on the foregoing and the discussion above pertaining to claim 1(c) (*supra* at 30-31), *Lira* discloses that the first translating distance in

U.S. Patent No. 7,469,381  
Issued: December 23, 2008

the first direction prior to reaching the edge of the document corresponds to the distance of movement of the object.

Thus, *Lira* discloses the preamble of claim 17. *See* Exhibit 6, Part B at 9-10.

*Lira Discloses Limitation 17(a)*: This limitation requires that displaying the area beyond the edge comprises “translating the electronic document in the first direction for a second associated translating distance.” *Lira* discloses this feature.

As discussed above in connection with claim 1(d) (*supra* at 32-34), *Lira* discloses the display of the area beyond the edge of the document comprises translating the electronic document in a first direction. *Lira* also discloses that this translation is for a second translating distance that is associated with the direction of translation. For example, as also discussed in connection with the independent claims (*supra* at 32-36), *Lira* discloses a “vertical alignment control” or “snap-to” function that aligns the display window to an edge of the electronic document, after the object is lifted from the screen. *Lira*, p. 15, lns. 18-31. As the display window moves between logical columns of the document, an area beyond the edge is displayed. *Supra* at 32-34. *Lira* allows the user to define a threshold between columns, which when crossed, the display window will “snap” forward by translating in the first direction to align with the next logical column, rather than “snap” back by translating in a second direction to align with the original column. *Lira*, p. 15, lns. 19-23. Thus, the electronic document can be translated in the same direction for a second associated translating distance which corresponds to the threshold between logical columns.

Thus, *Lira* discloses limitation 17(a). *See* Exhibit 6, Part B at 11-12.

*Lira Discloses Limitation 17(b)*: This limitation requires that “the second associated translating distance is less than a distance of movement of the object after reaching the edge of

U.S. Patent No. 7,469,381  
Issued: December 23, 2008

the electronic document.” It would have been obvious for the second translating distance to be less than the distance of movement of the stylus (*i.e.*, object) after reaching the edge of the electronic document.

*Lira* discloses a scrolling multiplier that can change the ratio between the distance of movement of the stylus (*i.e.*, object) and the amount of document translation. *Lira*, p.17, lns. 13-21. For example, when the multiplier is set such that “the proportional movement is set to 200%, document scrolling 1700 on a display 1705 is 20 pixels for each 10 pixels of stylus” movement. *Id.* Similarly, by adjusting the multiplier such that proportional movement is 50%, the translating distance of the document is less than the distance of movement of the stylus. Since this multiplier is merely a variable, it would have been obvious to decrease the multiplier (hence the proportional movement) from the set value, as the user translates the display window outside the original logical column (*i.e.*, beyond the edge of the electronic document). One of ordinary skill in the art would have been motivated to decrease this multiplier after reaching the edge (*i.e.*, when the user might be scrolling from one column to another) in order to prevent the user from inadvertently “snapping-to” the next logical column, thereby constraining the position of the visible portion of the displayed electronic document. *Lira*, p. 16, lns. 4-8. By providing a user-defined snap threshold, *Lira* allows the user to set a boundary which the system can use to evaluate the user’s gestures and determine his/her intention to “snap” from one column to another. *Lira*, p. 15, lns. 25-27. Similarly, preventing the user from easily/inadvertently “snapping” from column to column would help further capture and confirm the user’s intention as to whether to snap to the next column, which is one of *Lira*’s stated goals. *Id.* Thus, one of ordinary skill in the art would have been motivated to decrease the multiplier disclosed in *Lira* after reaching the edge of the document in order to further the stated goal in *Lira*. Modifying

U.S. Patent No. 7,469,381  
Issued: December 23, 2008

such an existing variable disclosed in *Lira* would have amounted to nothing more than an application of a known technique to achieve the predictable result of decreasing the translation distance in response to the object's movement.

Thus, *Lira* teaches or suggests limitation 17(b). *See* Exhibit 6, Part B at 12-14.

In view of the foregoing, *Lira* renders claim 17 obvious.

**6. Claim 18 should be rejected as rendered obvious by *Lira***

*Lira Discloses the preamble of claim 18:* Claim 18 depends from claim 1, and further requires that “translating in the first direction prior to reaching the edge of the electronic document has a first associated translating speed that corresponds to a speed of movement of the object.” *Lira* discloses this feature.

*Lira* states that “[m]oving the page of information may include moving the page a distance equal to a change in the coordinate information of the input tool multiplied by a factor based on the acceleration or the velocity of the input tool.” *Lira*, p. 5, lns. 13-15. Thus, based on the foregoing and the discussion above pertaining to claim 1(c) (*supra* at 30-31), the speed of translation in the first direction prior to reaching the edge corresponds to a speed of movement of the input tool (*i.e.*, object).

Thus, *Lira* discloses the preamble of claim 18. *See* Exhibit 6, Part B at 14.

*Lira Discloses Limitations 18(a)-(b):* Limitation 18(a) requires that displaying the area beyond the edge comprises “translating the electronic document in the first direction at a second associated translating speed.” Limitation 18(b) requires that the “second associated translating speed is slower than the first associated translating speed.” It would have been obvious to translate the document at a second speed that is slower than the first translating speed when displaying the area beyond the edge of the electronic document.

U.S. Patent No. 7,469,381  
Issued: December 23, 2008

*Lira* discloses a speed multiplier that can change the ratio between the movement of the stylus (*i.e.*, object) and the amount of document translation, based upon the speed of the object. *Lira*, p. 5, lns. 13-15. Thus, for example, by adjusting this speed multiplier such that the proportional value is 50%, the translating distance of the document is reduced for a given input object speed. This, in turn reduces the speed of translation, since speed is proportional to distance (*i.e.*,  $v=s/t$ ). Since this multiplier is merely a variable, it would have been obvious to decrease the multiplier as the user translates the display window outside the original logical column (*i.e.*, beyond the edge of the electronic document). One of ordinary skill in the art would have been motivated to decrease this multiplier after reaching the edge (*i.e.*, when the user might be scrolling from one column to another) in order to prevent the user from inadvertently “snapping-to” the next logical column, thereby constraining the position of the visible portion of the displayed electronic document. *Lira*, p. 16, lns. 4-8. By providing a user-defined snap threshold, *Lira* allows the user to set a boundary which the system can use to evaluate the user’s gestures and determine his/her intention to “snap” from one column to another. *Lira*, p. 15, lns. 25-27. Similarly, preventing the user from easily/inadvertently “snapping” from column to column would help further capture and confirm the user’s intention as to whether to snap to the next column, which is one of *Lira*’s stated goals. *Id.* Thus, one of ordinary skill in the art would have been motivated to decrease the multiplier disclosed in *Lira* after reaching the edge of the document in order to further the stated goal in *Lira*. Modifying such an existing variable disclosed in *Lira* would have amounted to nothing more than an application of a known technique to achieve the predictable result of decreasing the translation speed in response to the object’s movement.

Thus, *Lira* teaches or suggest limitations 18(a)-(b). See Exhibit 6, Part B at 14-16.

U.S. Patent No. 7,469,381  
Issued: December 23, 2008

In view of the foregoing, *Lira* renders claim 18 obvious.

**C. Claims 15, 17 and 18 should be rejected under 35 U.S.C. § 103 as rendered obvious by *Lira* in view of *Van Den Hoven***

As discussed above, *Lira* is a PCT patent application that was published on October 2, 2003, more than one year before the January 7, 2007 earliest possible effective filing date for the '381 Patent, and is therefore prior art to the '381 Patent under 35 U.S.C. § 102(b). Moreover, *Lira* was not cited nor considered by the Examiner during the prosecution or reexamination of the '381 Patent. *Supra* at 3.

As discussed above, *Van Den Hoven* is a PCT patent application that was published on April 26, 2001, more than one year before the January 7, 2007 earliest possible effective filing date for the '381 Patent, and is therefore prior art to the '381 Patent under 35 U.S.C. § 102(b). Moreover, *Van Den Hoven* was not cited nor considered by the Examiner during the prosecution or reexamination of the '381 Patent. *Supra* at 4.

*Van Den Hoven* describes a method for browsing a large collection of images on a handheld device. *Van Den Hoven*, p. 5, lns. 10-20. *Van Den Hoven* uses a windowed browsing area to select and view images from a sequence of images that are scrolled into the browsing area as if on a film strip. *Van Den Hoven*, p. 2, lns. 18-22. Scrolling from one image to another can be accomplished by user input strokes (*e.g.*, with a finger or stylus) inside the browsing area which results in a corresponding scroll distance or velocity. *Van Den Hoven*, p. 6, lns. 18-25.

It would have been obvious to one of ordinary skill in the art to combine the teachings of *Lira* with the teachings of *Van Den Hoven* as both references relate to handheld device displays and touch screen inputs. More specifically, *Lira* discloses a windowing method for viewing a web page too large for a handheld display, while *Van Den Hoven* provides a windowing method for viewing a large collection of images on a handheld display. Thus, both references discuss



U.S. Patent No. 7,469,381  
Issued: December 23, 2008

windowing methods for facilitating the viewing of electronic documents on small touch screen displays of handheld devices. Additionally, both methods allow a user to control the position of the window by touch input. Accordingly, it would have been obvious to combine the teachings of such closely-related references for the purposes of enhancing the user's experience with, and facilitating, the viewing of documents using touch screen displays.

As set forth in more detail below and in the chart attached at Exhibit 6, Part C, it is respectfully submitted that *Lira* in combination with *Van Den Hoven* renders obvious claims 15, 17 and 18 of the '381 Patent.

**1. Claim 15 should be rejected as rendered obvious by *Lira* in view of *Van Den Hoven***

Claim 15 depends from claim 1, and further requires that "translating the document in the second direction is a damped motion." As discussed above in connection with claim 1 (*supra* at 26-37), *Lira* discloses all the features recited in claim 1. *Van Den Hoven* discloses the additional feature recited in claim 15.

For example, *Van Den Hoven* discloses that the motion of the images (*i.e.*, translation of the document) through the browsing area "may simulate inertia and friction." *Van Den Hoven*, p. 3, ln. 24. This application of inertia or friction "gradually decreas[es] the scrolling speed, instead of instantaneously stopping [it]." *Van Den Hoven*, p. 3, lns. 24-27. As described in the '381 Patent (*see, e.g.*, col. 20:43-49), such a simulation of inertia and friction applied to the scrolling speed amounts to a "damped motion."

Moreover, *Lira* discloses a "snap-to" function that moves the document in the second direction so that when the user lifts the stylus or finger from the screen, "the logical column 1220 [will] snap into alignment with the display window 1205 as the user stops scrolling" by for example "snap[ping] to the nearest logical column." *Lira*, p. 15, lns. 19-25.

U.S. Patent No. 7,469,381  
Issued: December 23, 2008

It would have been obvious to modify *Lira's* “snap-to” motion in the second direction to include a frictional/inertial feature (*i.e.*, a damped motion) as disclosed in *Van Den Hoven*. One of ordinary skill in the art would have been motivated to implement *Van Den Hoven's* dampening feature with *Lira's* “snap-to” motion in order to provide a smoother transition between the document portions as the area beyond the edge is no longer displayed. Indeed, both *Lira* and *Van Den Hoven* are concerned with enhancing the user's experience in, and facilitating, the viewing of documents using touch screen displays. For example, *Lira* discloses improving readability and enabling users to get a better sense of their position in the document through scrolling animation effects. *Lira*, p. 1, lns. 10-14; p. 12, ln. 29 – p.13, ln. 13. Likewise, *Van Den Hoven* discloses smoothing the scrolling of the image sequence. *Van Den Hoven*, p. 2, ln. 22. Such an implementation of *Van Den Hoven's* dampening feature to *Lira's* snap to scrolling feature would have amounted to nothing more than an application of a known method (*e.g.*, scrolling with inertia and frictional simulation) to achieve the predictable result of providing for smoother/slower scrolling transitions.

Thus, *Lira* in combination with *Van Den Hoven* teaches each and every limitation of, and therefore renders obvious, claim 15. *See* Exhibit 6, Part C at 3-6.

**2. Claim 17 should be rejected as rendered obvious by *Lira* in view of *Van Den Hoven***

Claim 17 depends from claim 1, and further requires that translating the document in the first direction has a first associated translating distance that corresponds to a distance of movement of the object prior to reaching the edge of the electronic document and translating the document for a second associated translating distance that is less than a distance of movement of the object after reaching the edge of the electronic document. As discussed above in connection with claim 1 (*supra* at 26-37), *Lira* discloses all the features recited in claim 1.

U.S. Patent No. 7,469,381  
Issued: December 23, 2008

*Lira Discloses the preamble of claim 17:* The preamble of claim 17 requires that “translating in the first direction prior to reaching the edge of the electronic document has a first associated translating distance that corresponds to a distance of movement of the object prior to reaching the edge of the electronic document.” *Lira* discloses this feature.

*Lira* discloses that the page can scroll (*i.e.*, translate) an amount equal to the distance of movement of a stylus pen (*i.e.*, object). *Lira*, p. 17, lns. 5-9. *Lira* also discloses a scrolling multiplier that can change the ratio between the movement of the stylus and the amount of document translation. *Lira*, p.17, lns. 13-21. Thus, based on the foregoing and the discussion above pertaining to claim 1(c) (*supra* at 30-31), *Lira* discloses that the first translating distance in the first direction prior to reaching the edge of the document corresponds to the distance of movement of the object.

Thus, *Lira* discloses the preamble of claim 17. *See* Exhibit 6, Part C at 6-8.

*Lira Discloses Limitation 17(a):* This limitation requires that displaying the area beyond the edge comprises “translating the electronic document in the first direction for a second associated translating distance.” *Lira* discloses this feature.

As discussed above in connection with claim 1(d) (*supra* at 32-34), *Lira* discloses the display of the area beyond the edge of the document comprises translating the electronic document in a first direction. *Lira* also discloses that this translation is for a second translating distance that is associated with the direction of translation. For example, as also discussed in connection with the independent claims, *Lira* discloses a “vertical alignment control” or “snap-to” function that aligns the display window to an edge of the electronic document, after the object is lifted from the screen. *Lira*, p. 15, lns. 18-31. As the display window moves between logical columns of the document, an area beyond the edge is displayed. *Supra* at 32-24. *Lira*

U.S. Patent No. 7,469,381  
Issued: December 23, 2008

allows the user to define a threshold between columns, which when crossed, the display window will “snap” forward by translating in the first direction to align with the next logical column, rather than “snap” back by translating in a second direction to align with the original column. *Lira*, p. 15, lns. 19-23. Thus, the electronic document can be translated in the same direction for a second associated translating distance which corresponds to the threshold between logical columns.

Thus, *Lira* discloses limitation 17(a). See Exhibit 6, Part C at 8-10.

*Lira in view of Van Den Hoven Discloses Limitation 17(b)*: This limitation requires that “the second associated translating distance is less than a distance of movement of the object after reaching the edge of the electronic document.”

*Lira* discloses that the scrolling velocity of an electronic document may be varied (e.g., slowed down) as the document displayed within a browsing window approaches a particular view. *Lira*, p. 14, lns. 15-17. *Van Den Hoven* also discloses that the speed of translation in the first direction can be accelerated or slowed. *Van Den Hoven*, p. 3, lns 21-26; p. 6, lns. 27-32. *Van Den Hoven* further states that such acceleration/slowing down can be triggered as a function of the endpoint of the user’s input relative to a threshold, namely, the edge of a browsing area. *Van Den Hoven*, p. 3, lns 21-26. For example, a user input stroke that ends inside the browsing area may have a temporary acceleration; hence a first translating speed, followed by a deceleration period; hence a second slower translating speed. *Id.*

It would have been obvious to combine *Lira* with *Van Den Hoven* so that a user input applied to the *Lira* browsing window that remained inside the current logical column without exceeding the threshold at the edge of the document would result in a temporary acceleration (i.e., a first translating speed) followed by a deceleration period (i.e., a second slower translating

U.S. Patent No. 7,469,381  
Issued: December 23, 2008

speed) as described in *Van Den Hoven*. Thus, causing the document to be scrolled to the threshold rather than proceed past the threshold to the next logical column. Applying this deceleration feature to the user motion at the edge of the logical column (*i.e.*, the edge of the electronic document) would have the effect of shortening the translation (*i.e.*, decreasing the translating distance) relative to the distance of movement of the object (*e.g.*, stylus). Thus, the second associated translating distance is less than a distance of movement of the object after reaching the edge of the electronic document.

One of ordinary skill in the art would have been motivated to decelerate the scrolling velocity upon reaching the edge of the document (*i.e.*, when the user might be scrolling from one column to another) in order to prevent the user from inadvertently “snapping-to” the next logical column, thereby constraining the position of the visible portion of the displayed electronic document. *Lira*, p. 16, lns. 4-8. By providing a user-defined snap threshold, *Lira* allows the user to set a boundary which the system can use to evaluate the user’s gestures and determine his/her intention to “snap” from one column to another. *Lira*, p. 15, lns. 25-27. Similarly, preventing the user from easily/inadvertently “snapping” from column to column would help further capture and confirm the user’s intention as to whether to snap to the next column, which is one of *Lira*’s stated goals. *Id.* Thus, one of ordinary skill in the art would have been motivated to slow the scrolling velocity disclosed in *Lira* according to a user input within the user’s defined threshold in order to further the stated goal in *Lira*. Such triggering of the scroll deceleration feature disclosed in *Lira* based on the endpoint of the user’s gesture as disclosed in *Van Den Hoven*, would have amounted to nothing more than an application of known methods (*e.g.*, scroll deceleration) to achieve the predictable result of stopping the scrolling motion before reaching the threshold disclosed in *Lira*.

U.S. Patent No. 7,469,381  
Issued: December 23, 2008

Thus, *Lira* in combination with *Van Den Hoven* teaches limitation 17(b) of, claim 17.  
*See* Exhibit 6, Part C at 10-13.

In view of the foregoing, *Lira* in combination with *Van Den Hoven* teaches each and every limitation of, and therefore renders obvious, claim 17.

**3. Claim 18 should be rejected as rendered obvious by *Lira* in view of *Van Den Hoven***

Claim 18 depends from claim 1, and further requires that translating the document in the first direction has a first speed that corresponds to a speed of movement of the object and translating document in the first direction at a second associated translating speed at a speed that is slower than the first after displaying an area beyond the edge of the document. As discussed above in connection with claim 1 (*supra* at 26-37), *Lira* discloses all the features recited in claim 1.

*Lira* Discloses the preamble of claim 18: The preamble of claim 18 requires that “translating in the first direction prior to reaching the edge of the electronic document has a first associated translating speed that corresponds to a speed of movement of the object.” *Lira* discloses this feature.

*Lira* states that “[m]oving the page of information may include moving the page a distance equal to a change in the coordinate information of the input tool multiplied by a factor based on the acceleration or the velocity of the input tool.” *Lira*, p. 5, lns. 13-15. Thus, based on the foregoing and the discussion above pertaining to claim 1(c) (*supra* at 30-31), the speed of translation in the first direction prior to reaching the edge corresponds to a speed of movement of the input tool (*i.e.*, object).

Thus, *Lira* discloses the preamble of claim 18. *See* Exhibit 6, Part C at 13-14.

U.S. Patent No. 7,469,381  
Issued: December 23, 2008

*Lira in view of Van Den Hoven Discloses Limitations 18(a)-(b):* Limitation 18(a)

requires that displaying the area beyond the edge comprises “translating the electronic document in the first direction at a second associated translating speed.” Limitation 18(b) requires that the “second associated translating speed is slower than the first associated translating speed.”

*Lira* discloses that the scrolling velocity of an electronic document may be varied (*e.g.*, slowed down) as the document displayed within a browsing window approaches a particular view. *Lira*, p. 14, lns. 15-17. *Van Den Hoven* also discloses that the speed of translation in the first direction can be accelerated or slowed. *Van Den Hoven*, p. 3, lns 21-26; p. 6, lns. 27-32. *Van Den Hoven* further states that such acceleration/slowing down can be triggered as a function of the endpoint of the user’s input relative to a threshold, namely, the edge of a browsing area. *Van Den Hoven*, p. 3, lns 21-26. For example, a user input stroke that ends inside the browsing area may have a temporary acceleration; hence a first translating speed, followed by a deceleration period; hence a second slower translating speed. *Id.*

It would have been obvious to combine *Lira* with *Van Den Hoven* so that a user input applied to the *Lira* browsing window that remained inside the current logical column without exceeding the threshold at the edge of the document would result in a temporary acceleration (*i.e.*, a first translating speed) followed by a deceleration period (*i.e.*, a second slower translating speed) as described in *Van Den Hoven*. Thus, causing the document to be scrolled to the threshold rather than proceed past the threshold to the next logical column. Applying this deceleration feature to the user motion at the edge of the logical column (*i.e.*, the edge of the electronic document) would have the effect of decreasing the scrolling velocity relative to the velocity of the object (*e.g.*, stylus). Thus, the second associated translating speed is less than the first translating speed at the edge of the document.

U.S. Patent No. 7,469,381  
Issued: December 23, 2008

One of ordinary skill in the art would have been motivated to decelerate the scrolling velocity upon reaching the edge of the document (*i.e.*, when the user might be scrolling from one column to another) in order to prevent the user from inadvertently “snapping-to” the next logical column, thereby constraining the position of the visible portion of the displayed electronic document. *Lira*, p. 16, lns. 4-8. By providing a user-defined snap threshold, *Lira* allows the user to set a boundary which the system can use to evaluate the user’s gestures and determine his/her intention to “snap” from one column to another. *Lira*, p. 15, lns. 25-27. Similarly, preventing the user from easily/inadvertently “snapping” from column to column would help further capture and confirm the user’s intention as to whether to snap to the next column, which is one of *Lira*’s stated goals. *Id.* Thus, one of ordinary skill in the art would have been motivated to slow the scrolling velocity disclosed in *Lira* according to a user input within the user’s defined threshold in order to further the stated goal in *Lira*. Such triggering of the scroll deceleration feature disclosed in *Lira* based on the endpoint of the user’s gesture as disclosed in *Van Den Hoven*, would have amounted to nothing more than an application of known methods (*e.g.*, scroll deceleration) to achieve the predictable result of stopping the scrolling motion before reaching the threshold disclosed in *Lira*.

Thus, *Lira* in combination with *Van Den Hoven* teaches limitation 18(a)-(b) of, claim 18. *See* Exhibit 6, Part C at 14-17.

In view of the foregoing, *Lira* in combination with *Van Den Hoven* teaches each and every limitation of, and therefore renders obvious, claim 18.



U.S. Patent No. 7,469,381  
Issued: December 23, 2008

**D. Claims 1-5, 7-13 and 15-20 of the '381 Patent should be rejected under 35 U.S.C. § 102(e) as anticipated by *Ording***

As discussed above, *Ording* is a U.S. patent that issued on a U.S. application that was filed on December 23, 2005, long before the January 7, 2007 earliest possible priority date for the '381 Patent, and is therefore prior art to the '381 Patent under 35 U.S.C. § 102(e). Moreover, *Ording* was not cited nor considered by the Examiner during the prosecution or reexamination of the '381 Patent. *Supra* at 3-4.

*Ording* generally relates to the scrolling of lists (*i.e.*, electronic documents) on handheld devices with touch-sensitive displays. *Ording*, col. 1:18-20. Similar to the '381 Patent, *Ording* seeks to reduce or eliminate the supposed deficiencies in prior art user interfaces for touch screen devices. *Ording*, col. 1:34-47. At the most basic level, *Ording* translates a displayed list in response to the contact and movement of a user's fingers on the touch screen. *Ording*, col. 1:50-54.

According to *Ording*, the scrolled lists contain items such as names addresses, photographs or other contact information. *Ording*, col. 3:59-66. The user's movement on the touch screen determines the corresponding first scroll direction along with its velocity and/or distance. *Ording*, col. 4:1-6, col. 7:44-49. The speed of scrolling (*i.e.*, translation) can also be further affected by other factors such as application of inertial models. *Ording*, col. 4:6-14. Figure 6 illustrates the portable handheld device, an exemplary scrolled list of information items and the user's interaction with the touch screen.

U.S. Patent No. 7,469,381  
 Issued: December 23, 2008

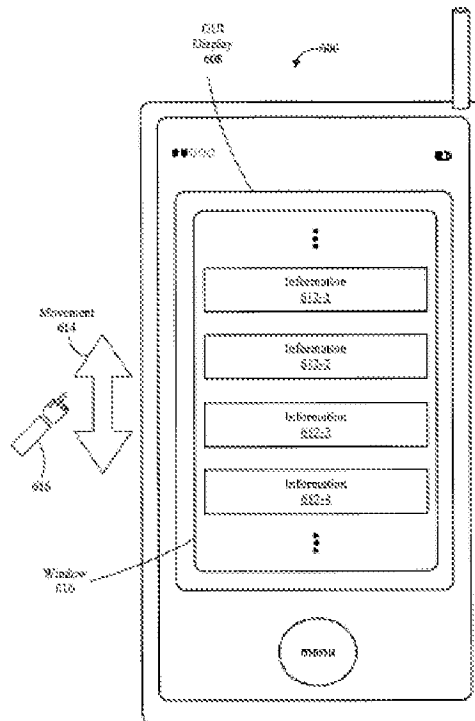

Figure 6

To provide additional user feedback, *Ording* discloses the automatic reversal of the scroll direction as an endpoint of the displayed list contacts and “bounces” off a virtual boundary or boundaries, defined as the terminus. *Ording*, col. 4:44-51. The movement of the list in the second direction can be similarly modified by friction or elastic models, very similar to how the motion in the first direction can be affected. *Ording*, 4:47-59.

To scroll the list, the user issues a stroke (*i.e.*, a movement) on the touch screen display with a finger (*i.e.*, object), and the displayed information items change until the first item, list item **612-1**, and the edge are reached, in which case an area beyond the edge of the electronic document is displayed. As the first item in the list approaches the terminus, the displayed list may bounce off the virtual boundary and reverse direction. In response to the user breaking contact with the touch screen (*i.e.*, removing the object so that it is no longer detected on the display), the document is free to scroll in the opposite direction (*i.e.*, translate in a second

U.S. Patent No. 7,469,381  
Issued: December 23, 2008

direction) since item **621-1** remains in contact with or has touched the terminus. The area beyond the edge will decrease in size until it disappears as the first item reaches the top of the display, and a new portion of the page is displayed instead.

As explained in more detail below, *Ording* discloses the features claimed in the '381 Patent. In fact, *Ording* discloses these features using very similar language to that used in the '381 Patent, which is not surprising given that both patents share a common inventor and were prosecuted by the same firm. Yet, remarkably, *Ording* was never disclosed to the Examiner during the reexamination of the '381 Patent, nor during the original prosecution of the underlying application.

As set forth in more detail below and in the chart attached at Exhibit 6, Part D, it is respectfully submitted that *Ording* anticipates claims 1-5, 7-13 and 15-20 of the '381 Patent.

**1. Claims 1, 19 and 20 should be rejected as anticipated by *Ording***

As explained above in Section II.B.1 (*supra* at 11-12), independent claims 1, 19, and 20 of the '381 Patent recite substantially similar limitations, and are therefore treated together in the section below. *Ording* discloses each and every limitation of these claims.

*Ording Discloses the Preambles of Claims 1, 19 and 20:* The preamble of claim 1 recites a “computer-implemented method,” while the preamble of claim 19 recites a “device.” The preamble of claim 20 recites a “computer readable storage medium having stored therein instructions” which are “executed by a device with a touch screen display.” *Ording* discloses these features.

*Ording* discloses that the “[i]nstructions for performing the aforementioned methods may be included in a computer program product configured for execution by one or more processors.” *Ording*, col. 2:30-32. Therefore, *Ording* discloses a computer implemented method as required in the claim 1 preamble.

U.S. Patent No. 7,469,381  
Issued: December 23, 2008

*Ording* also explains that “[t]he aforementioned methods may be performed by a portable electronic device having a touch sensitive display, a processor, memory and one or more programs or sets of instructions stored in the memory for performing these methods.” *Ording*, col. 2:23-27. Therefore, *Ording* discloses the device required in the claim 19 preamble.

Furthermore, given that the foregoing demonstrates that the methods disclosed by *Ording* can be included in a computer program product for execution on a portable device having a touch sensitive (*i.e.*, touch screen) display, *Ording* discloses the preamble of claim 20.

Thus, *Ording* discloses the preambles of claims 1, 19 and 20. *See* Exhibit 6, Part D at 1, 33 and 36-37.

*Ording Discloses Limitations 1(a) and 19(a)*: These limitations require that the device have a “touch screen display.” As discussed directly above, *Ording* discloses this feature. For example, *Ording* explains that “[t]he aforementioned methods may be performed by a portable electronic device having a touch sensitive display.” *Ording*, col. 2:23-24.

Thus, *Ording* discloses claim limitations 1(a) and 19(a). *See* Exhibit 6, Part D at 1 and 33.

*Ording Discloses Limitations 19(b)-(d)*: These limitations require that the device include “one or more processors,” “memory” and “one or more programs, wherein the one or more programs are stored in the memory and configured to be executed by the one or more processors.” *Ording* discloses these features.

As discussed above in relation to the preambles, *Ording* discloses that the device has one or more processors and memory. For example, *Ording* discloses “a portable electronic device having a touch sensitive display, a processor, memory.” *Ording*, col. 2:23-25. Also, *Ording* discloses that the device **1200** in Figure 12 may include a “memory controller **1212**, one or more

U.S. Patent No. 7,469,381  
Issued: December 23, 2008

data processors,” “image processors and/or central processing units **1214**.” *See Ordning*, col. 12:17-23.

Also, *Ordning* discloses that there are one or more programs stored in the memory for execution on one or more processors. According to *Ordning*, the “memory may store an operating system,” which is a type of program. *Ordning*, col. 13:22-23. Also, the memory may store programs such as procedures, modules and sets of instructions. Among other examples, modules disclosed in *Ordning* include modules for communicating with other devices or computers, modules “for governing the scrolling of a list on the display”, and modules that “determine the point of contact and/or its movement.” *See Ordning*, col. 13:28-38. Thus, *Ordning* discloses one or more programs stored in the memory. As discussed above, *Ordning* also states that these programs are executed on, and the corresponding methods are performed by, the one or more processors. *Ordning*, col. 2:23-25.

Thus, *Ordning* discloses limitations 19(b)-(d). *See* Exhibit 6, Part D at 34-35.

*Ordning Discloses Limitations 1(b), 19(e) and 20(a)*: These limitations require displaying “a first portion of an electronic document.” *Ordning* discloses this feature.

*Ordning* discloses that the touch-sensitive display can display an electronic document. Much like in the ‘381 Patent (*See, e.g.*, col. 24:1-4), an example of an electronic document that a user may view through the device is a list. *Ordning*, abstract.<sup>4</sup> Items such as contact information/address book or photographs may be included in the list displayed in *Ordning*’s touch-sensitive display. *Ordning*, col. 3:60-66, Figure 6.

---

<sup>4</sup> A list of items may have a number of subsets, where each subset may have a number of categories. *Ordning* at col. 5:10-16; *see also Ordning* Patent Figure 13. Thus, the list of items may take on the appearance of a spreadsheet, which is another example of an electronic document disclosed in the ‘381 Patent (*see, e.g.*, col. 27:10-12).

U.S. Patent No. 7,469,381  
 Issued: December 23, 2008

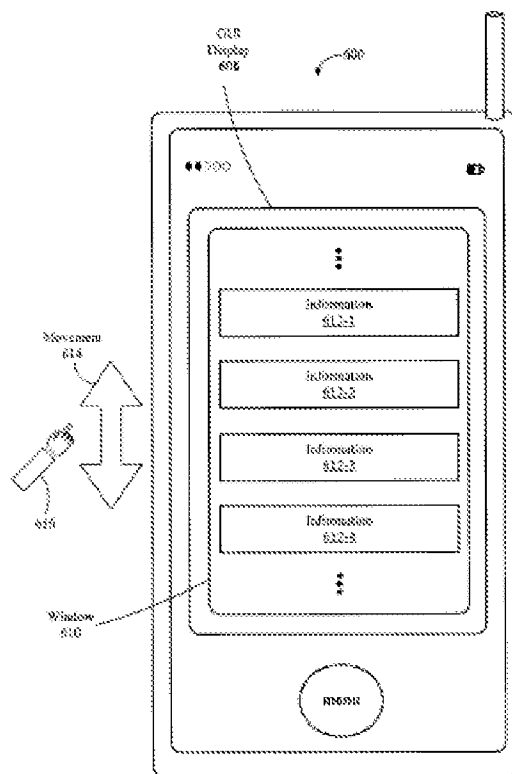

Figure 6

Figure 6 illustrates how the “first portion” of the electronic document may be displayed on the device. A “first portion” may be displayed as the electronic document is first brought into view on the device or after the display reaches a quiescent state upon the completion of display operations (*e.g.*, translation) arising from a user input (contact, remove, complete translation). For example, window **610** may show any of four information items from a larger list, of which items **612-2**, **612-3**, **612-4** and **612-5** could comprise the “first portion” (instead of pictured items **612-1 - 612-4**), after a series of completed user inputs **614** scrolled information item **614-1** off of the display and item **612-5** onto the display.

Thus, *Ording* discloses limitations 1(b), 19(e) and 20(a). See Exhibit 6, Part D at 1-3, 35 and 37.

U.S. Patent No. 7,469,381  
Issued: December 23, 2008

Ording Discloses Limitations 1(c), 19(f) and 20(b): These limitations require detecting “a movement of an object on or near the touch screen display,” and “in response to detecting the movement,” translating the electronic document “in a first direction to display a second portion of the electronic document.” These limitations further require that the second portion be different from the first portion. *Ording* discloses these features.

*Ording* discloses detecting a movement of an object - namely, a user’s finger/point of contact (which, is an example of an object disclosed in the ‘381 Patent (*see, e.g.*, col. 2:47-50)) - on the touch screen display. For example, *Ording* discloses that the movement of a user’s point contact on a touch-sensitive display (*i.e.* touch screen) is determined. *Ording*, col. 1:51-52, col. 4:14-21. In fact, the first step in the process depicted in Figure 1 of *Ording* pertains to detecting the object on the touch screen:

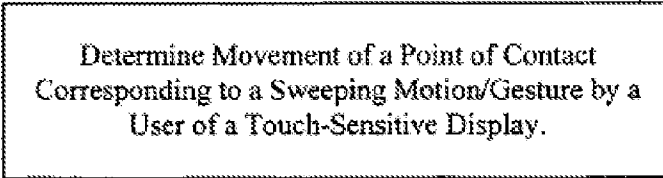

Determine Movement of a Point of Contact  
Corresponding to a Sweeping Motion/Gesture by a  
User of a Touch-Sensitive Display.

*Ording* discloses translating the electronic document in a first direction in response to detecting the movement. For example, *Ording* discloses that the list (*i.e.*, electronic document) may be scrolled (*i.e.*, translated) in response to the determined movement. *Ording*, col. 3:66-4:5. In fact, the second step in the process depicted in Figure 1 pertains to scrolling the list in response to the detected movement:

U.S. Patent No. 7,469,381  
Issued: December 23, 2008

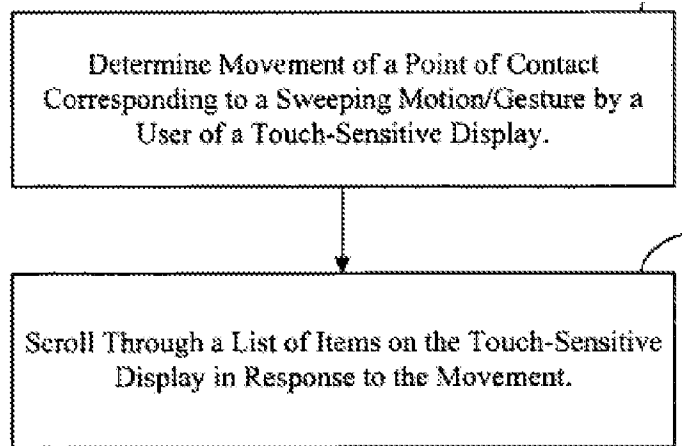

*Ording* also shows that the list may be scrolled in a direction corresponding to the user's motion (*i.e.*, a first direction). *Ording*, col. 6:17-21. For example, an upward movement on the touch screen causes the list to translate upward, thereby causing earlier entries in the list to be displayed. *Ording*, col. 6:21-24. Similarly, a downward movement causes the list to translate downwards, thereby causing later entries to be displayed. *Ording*, col. 6:28-33. Thus, according to *Ording*, a second portion of the list that is different than the first portion is displayed in response to the detected movement. This is because the entries shown in each portion are not the same given that a different entry (*e.g.*, an earlier or later entry) is displayed when the list is scrolled.



U.S. Patent No. 7,469,381  
 Issued: December 23, 2008

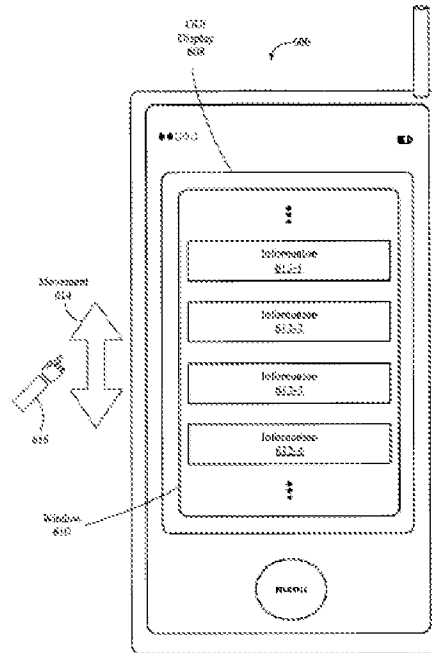

Figure 6

Figure 6 illustrates how different portions of the electronic document may be displayed on the device. As stated in connection with the description of limitations 1(b), 19(e) and 20(a) above, a “first portion” shown in window **610** provides for the display of four information items from a larger list, namely **612-2**, **612-3**, **612-4** and **612-5**. The “second portion” is displayed as an intermediate graphical output arising from an ongoing user input **614** from finger/object **616** (e.g., contact has not been broken). Information item **612-1** may be partially or completely scrolled onto the display, while item **612-5** may be partially or completely scrolled off the display and items **612-2**, **612-3**, **612-4** will be translated up/down the display. Since no previously displayed information item is in the same position now as in the first portion, and since the items shown in window **610** have changed from **612-2** through **612-5** to **612-1** through **612-4**, the second portion is different than the first portion.

U.S. Patent No. 7,469,381  
Issued: December 23, 2008

The foregoing demonstrates that *Ording* discloses detecting a movement of an object on the touch screen display and, in response, translating the electronic document to display a second portion of the electronic document that is different from the first.

Thus, *Ording* discloses limitations 1(c), 19(f) and 20(b). See Exhibit 6, Part D at 3-7, 35 and 37.

*Ording Discloses Limitations 1(d), 19(g) and 20(c)*: These limitations require that “in response to an edge of the electronic document being reached while translating the electronic document in the first direction while the object is still detected on or near the touch screen display,” displaying “an area beyond the edge of the document” and “a third portion of the electronic document.” These limitations further require that the third portion be “smaller than the first portion.” *Ording* discloses these features.

*Ording* discloses in response to an edge of the electronic document being reached (while translating the document in the first direction and while the object is still detected on the touch screen): displaying an area beyond the edge of the document. *Ording* discloses that each list has a beginning and an end or a first and last item. *Ording*, col. 6:60-65. Thus, it follows that there is no item before the first item and no item after the last item. Given that there are no items located at the top of the display, and thus no item to display when a user keeps scrolling beyond the first list item, what is displayed above the first item is an area beyond the edge<sup>5</sup> of the list (*i.e.*, electronic document). *Ording* Figures 7A-B illustrate the state of the display as a list is

---

<sup>5</sup> In fact, in discussing embodiments of methods “of scrolling through a list,” *Ording* even refers to a “virtual region” in which a symbol may be displayed as an alternative to displaying the symbol adjacent to list items (*i.e.*, in the list itself). Given that the virtual region is an alternative location and thus different than any portions of the list (*i.e.*, electronic document), it would follow that the virtual region would be separate from, and outside of (*e.g.*, above or below), the electronic document. Such a virtual region may therefore be considered to be an area beyond the edge of the document that is displayed while translating the document (*i.e.*, during scrolling). *Ording*, col. 10:13-15; col. 10:29-33; col. 10:37-40; col. 10:51-55.

U.S. Patent No. 7,469,381  
 Issued: December 23, 2008

scrolled and first item **612-1** moves toward the terminus. As first item **612-1** moves downwards, the area above the item increases in size while the area below decreases in size. Thus, *Ording* discloses that as the first item moves downwards towards the terminus, the area above the first item (*i.e.*, the area beyond the edge) is [already] displayed and increases in size as the list is scrolled. The below annotated figure highlights an exemplary third portion of the electronic document along with an area beyond the edge of the document.

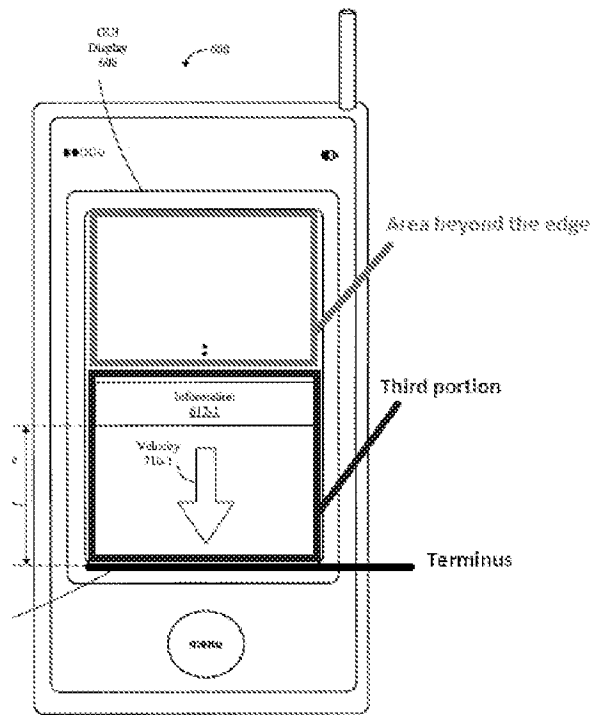

Figure 7A

*Ording* also discloses displaying a third portion of the electronic document that is smaller than the first portion. Continuing the example illustrated in the same annotated figure herein, as the user scrolls beyond the edge of the document/list, the displayed portion of the list (*e.g.*, the area that includes and is below item **612-1**) gets smaller as the area beyond the edge increases in size because the screen is only devoting a portion of its display area to the list contents. This displayed portion of the list contents correspond to a third portion and is smaller in size than the

U.S. Patent No. 7,469,381  
Issued: December 23, 2008

first portion which would include only list contents as discussed in connection with limitations 1(b), 19(e) and 20(a).

The foregoing demonstrates that *Ording* discloses, in response to an edge of the electronic document being reached while translating the electronic document in the first direction while the object is still detected on the touch screen, displaying an area beyond the edge of the document, and a third portion that is smaller than the first portion.

Thus, *Ording* discloses limitations 1(d), 19(g) and 20(c). *See* Exhibit 6, Part D at 7-10 and 35-37.

*Ording Discloses Limitations 1(e), 19(h) and 20(d)*: These limitations require that “in response to detecting that the object is no longer on or near the touch screen display,” translating the document “in a second direction until the area beyond the edge of the electronic document is no longer displayed to display a fourth portion of the electronic document. These limitations further require that the fourth portion be “different from the first portion.” *Ording* discloses these features.

*Ording* discloses, in response to detecting that the object is no longer on the touch screen display, translating the electronic document in a second direction until the area beyond the edge of the electronic document is no longer displayed to display a fourth portion of the electronic document. For example, the relevant list disclosed in *Ording* includes six information items (*e.g.*, **612-1**, **612-2**, **612-3**, **612-4**, **612-5**, and **612-6**) whereas the window is capable of displaying four information items at once. *See Ording*, Figure 6. To scroll the list, the user issues a downward stroke (*i.e.*, a movement) on the touch screen display with a finger (*i.e.*, object), and the displayed information items change until the first item, list item **612-1**, and the corresponding edge of the document are reached, in which case an area beyond the edge of the electronic

U.S. Patent No. 7,469,381  
Issued: December 23, 2008

document is displayed as discussed above. *Ording* teaches that scrolling (*i.e.*, translation) may be stopped in response to the establishment of a substantially stationary point of contact on the touch screen display. *Ording*, col. 8:30-36. Although the cessation of scrolling is disclosed as part of the breaking and re-establishment of contact on the touch screen, *Ording* further teaches that some operations may be omitted, added, combined or reordered. *Ording*, col. 8:22-39.

As a result of either the displacement or velocity of the user's input movement, list item **612-1** can now come into contact with the terminus as illustrated in *Ording*. *See, e.g., Ording*, Figure 7B. As the first item in the list approaches the terminus, the displayed list may bounce off the virtual boundary and reverse direction. *Ording*, 4:44-51. Although contact with the terminus by a first list item such as item **612-1** can cause the direction of scrolling to reverse as in *Ording* Figures 7B-7C, precedence to the user's continued contact with the touch screen may be instead given so as to cause information item **621-1** to remain at the terminus. *Ording*, col. 8:30-36; *see also Ording*, col. 8:40-53 (stating that some operations may be omitted, added, combined or reordered in the context of discussing the terminus and reversing the direction of scroll).

Accordingly, in response to the user breaking contact with the touch screen (*i.e.*, removing the object so that it is no longer detected), the override on the scroll reversal is cancelled and the document is free to scroll in the opposite direction (*i.e.*, move in a second direction) since item **621-1** remains in contact with or has touched the terminus. *Ording*, col. 9:25-27. The annotated figure below depicts the state of the display after first item **612-1** has reached the terminus and has started to translate in the opposite direction (information items **612-2** - **612-6** are not shown but would sit below item **612-1** as in Figure 6). The highlighted area beyond the edge will decrease in size until it disappears as the first item reaches the top of the display.

U.S. Patent No. 7,469,381  
 Issued: December 23, 2008

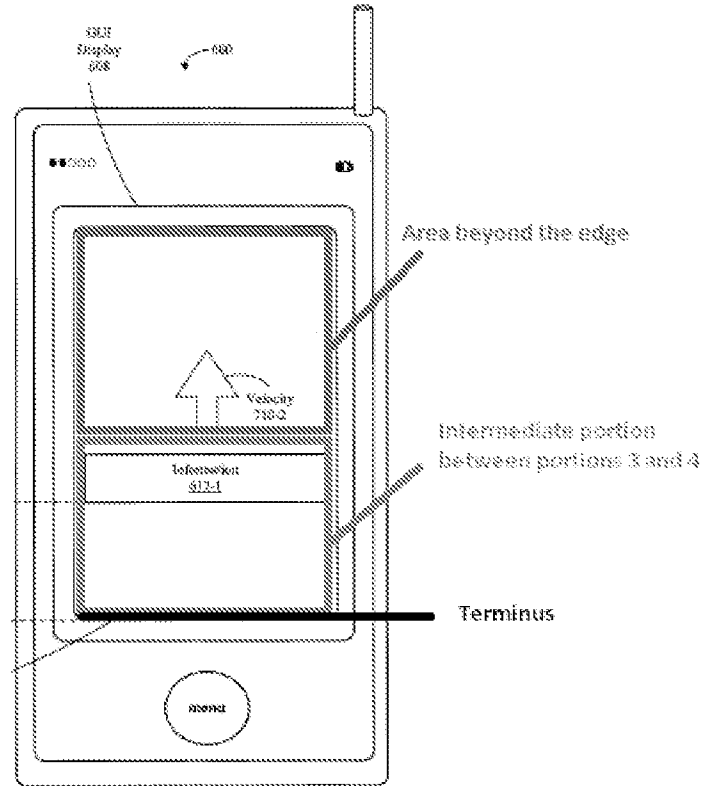

Figure 7C

According to *Ording*, “[a]fter the ... scrolling direction reversal, the scrolling may automatically stop so as to leave the first or last item of the list in view on the touch-sensitive display.” *Ording*, col. 6:50-65. Thus, as a result of automatically stopping the movement in the second direction when the first or last item is in view, either information item **612-1** or **612-6** will be displayed. Since neither information item **612-1** nor item **612-6** were displayed with the first portion (which displayed items **612-2** - **612-5**), the reversal will result in a fourth displayed portion that is different from the first portion shown in the discussion pertaining to limitations 1(b), 19(e) and 20(a). The annotated figure below highlights the display returning to a quiescent state, an exemplary fourth portion of the electronic document, the area beyond the edge no longer being displayed and information item **612-1** now in view.

U.S. Patent No. 7,469,381  
 Issued: December 23, 2008

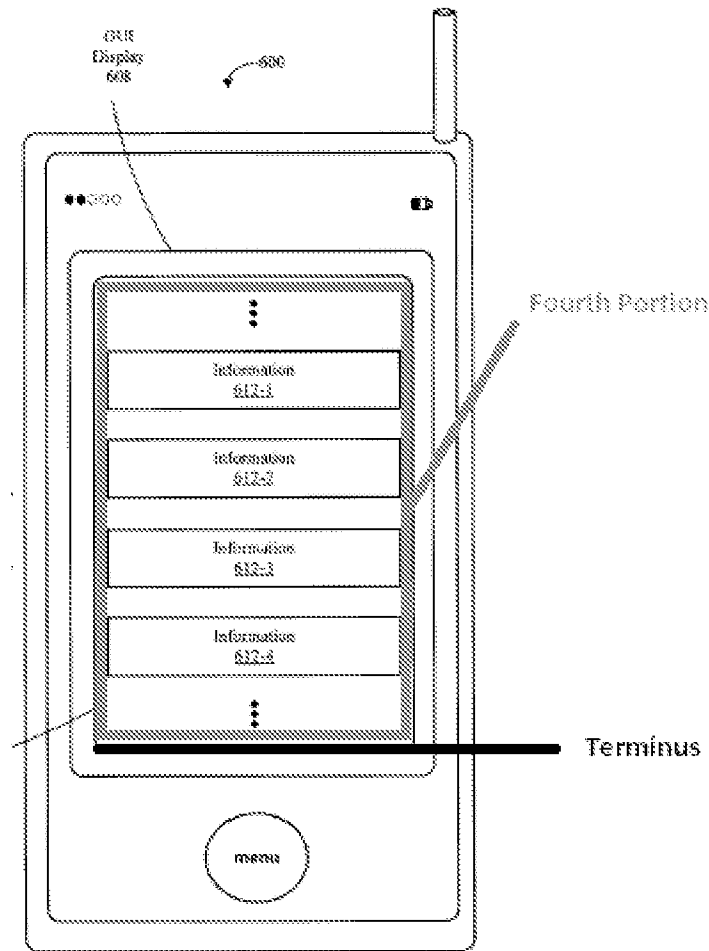

Figure 6

The foregoing demonstrates that *Ording* discloses that, in response to detecting that the object is no longer on the touch screen display, translating the electronic document in a second direction until the area beyond the edge of the electronic document is no longer displayed to display a fourth portion that is different from the first portion of the electronic document.

Thus, *Ording* discloses limitations 1(e), 19(h) and 20(d). See Exhibit 6, Part D at 10-17, 36 and 38.

In view of the foregoing, *Ording* discloses each and every limitation of, and therefore anticipates, claims 1, 19 and 20.

U.S. Patent No. 7,469,381  
Issued: December 23, 2008

**2. Claim 2 should be rejected as anticipated by *Ording***

Claim 2 depends from claim 1, and further requires that “the first, second, third and fourth portions of the electronic document be “displayed at the same magnification.” *Ording* discloses this feature.

As seen in *Ording* Figures 6, and 7A-7C, the relative size of the list items, and therefore the list or electronic document itself, remain the same as the user scrolls through the list, thereby showing that the first, second, third and fourth portions discussed above in connection with the independent claim 1 (*supra* at 71-75), are displayed at the same magnification.

Thus, *Ording* anticipates claim 2. *See* Exhibit 6, Part D at 18.

**3. Claim 3 should be rejected as anticipated by *Ording***

Claim 3 depends from claim 1, and further requires that the “movement of the object is on the touch screen display.” *Ording* discloses this feature.

*Ording* discloses that the movement is detected with reference to the user’s point of contact such as a finger (*i.e.*, the object) with the touch-sensitive display. *Ording*, col. 1:51-55, col. 4:16-18. With the point of contact and movement being made with the touch-sensitive display, the movement of such an object is on the touch screen display.

Thus, *Ording* anticipates claim 3. *See* Exhibit 6, Part D at 18-19.

**4. Claim 4 should be rejected as anticipated by *Ording***

Claim 4 depends from claim 1, and further requires that “the object is a finger.” *Ording* discloses this feature.

*Ording* discloses that “the user may make contact with the touch-sensitive display, swipe or sweep one or more of his or her fingers along the display.” *Ording*, col. 4:16-21. *Ording* therefore discloses that the point of contact (*i.e.*, object) is a finger.

Thus, *Ording* anticipates claim 4. *See* Exhibit 6, Part D at 19.



U.S. Patent No. 7,469,381  
Issued: December 23, 2008

**5. Claim 5 should be rejected as anticipated by *Ording***

Claim 5 depends from claim 1, and further requires that the “first direction is a vertical direction, a horizontal direction, or a diagonal direction.” *Ording* discloses this feature.

*Ording* discloses that the direction of scrolling (*i.e.*, the first translation direction) can be in the same direction as the detected user’s movement. *Ording*, col. 6:19-21. Furthermore, the user can make upwards or downward sweeps (*i.e.*, vertically) with an object on the touch-sensitive screen and have the list scroll in the same direction on the display. *Ording*, col. 6:21-28, 33-35. Also, *Ording* Figures 6 and 7A-C show the displayed list being translated in a linear direction (*i.e.*, vertically, horizontally, or diagonally).

Thus, *Ording* anticipates claim 5. *See* Exhibit 6, Part D at 19-20.

**6. Claim 7 should be rejected as anticipated by *Ording***

Claim 7 depends from claim 1, and further requires that the “the electronic document is a digital image.” *Ording* discloses this feature.

*Ording* discloses that the list of items may contain a photograph (*i.e.*, digital image). *Ording*, col. 3:62-66. In addition, *Ording* describes the list itself as an image. *Ording*, col. 2:17-22.

Thus, *Ording* anticipates claim 7. *See* Exhibit 6, Part D at 20-21.

**7. Claim 8 should be rejected as anticipated by *Ording***

Claim 8 depends from claim 1, and further requires that the “electronic document is a word processing, spreadsheet, email or presentation document.” *Ording* discloses this feature.

*Ording* discloses that a list of items may have a number of subsets, where each subset may have a number of categories. *Ording*, col. 5:10-16; *see also Ording*, Figure 13. Thus, the list of items may take on the appearance of a spreadsheet. *Ording* further discloses that the translation of displayed documents can occur in multiple directions. *Ording*, col. 9:2-8. Thus

U.S. Patent No. 7,469,381  
Issued: December 23, 2008

allowing the user to easily scroll through horizontally and vertically aligned categories on a spreadsheet.

Thus, *Ording* anticipates claim 8. *See* Exhibit 6, Part D at 21-22.

**8. Claim 9 should be rejected as anticipated by *Ording***

Claim 9 depends from claim 1, and further requires that the “electronic document includes a list of items.” *Ording* discloses this feature.

*Ording* discloses that the electronic document may include a list of items (*e.g.*, names, addresses, photographs, contact information). *Ording*, col. 3:61-66.

Thus, *Ording* anticipates claim 9. *See* Exhibit 6, Part D at 22-23.

**9. Claim 10 should be rejected as anticipated by *Ording***

Claim 10 depends from claim 1, and further requires that the “second direction is opposite the first direction.” *Ording* discloses this feature.

*Ording* discloses that when the endpoint (*i.e.* beginning or end) of a list reaches the terminus, the direction of scrolling may be reversed (*i.e.*, the movement is in an opposite direction). *Ording*, col. 6:60-66, col. 4:45-46. *Ording* Figures 7A-7C illustrate the initial scrolling (*i.e.*, translating) direction and the subsequent movement in the opposite direction upon the first item (*i.e.*, edge of the document) reaching the terminus.

Thus, *Ording* anticipates claim 10. *See* Exhibit 6, Part D at 23-24.

**10. Claim 11 should be rejected as anticipated by *Ording***

Claim 11 depends from claim 1, and further requires that the “translating in the first direction prior to reaching an edge of the document has an associated speed of translation that corresponds to a speed of movement of the object.” *Ording* discloses this feature.

*Ording* discloses that the scrolling speed can be correlated with the kinematics of the detected input movement. *Ording*, col. 3:66-col. 4:6. For example, *Ording* discloses that the

U.S. Patent No. 7,469,381  
Issued: December 23, 2008

scrolling speed may be in accordance with estimates of speed, velocity and acceleration of the input movement acquired over a time interval. *Ording*, col. 7:6-12. Thus, the speed of translation in the first direction prior to reaching the edge corresponds to a speed of the movement of the user's finger (*i.e.*, the object).

Thus, *Ording* anticipates claim 11. *See* Exhibit 6, Part D at 24-25.

**11. Claim 12 should be rejected as anticipated by *Ording***

Claim 12 depends from claim 1, and further requires that the “translating in the first direction is in accordance with a simulation of an equation of motion having friction.” *Ording* discloses this feature.

*Ording* discloses that “the scrolling and acceleration of the scrolling may be in accordance with a simulation of a physical device having friction, *i.e.*, damped motion.” *Ording*, col. 4:6-9. Additionally, friction or damped motion may correspond with motion equations having mass, inertial and dissipative (*i.e.*, frictional) terms. *Ording*, col. 4:9-12. Thus, *Ording* discloses that the translation is in accordance with a simulation of an equation of motion having friction.

Thus, *Ording* anticipates claim 12. *See* Exhibit 6, Part D at 25.

**12. Claim 13 should be rejected as anticipated by *Ording***

Claim 13 depends from claim 1, and further requires that the “area beyond the edge of the document is black, gray, a solid color, or white.” *Ording* discloses this feature.

As presented earlier in the discussion of limitation 1(d) (*supra* at 70-72), annotated Figure 7A shows the state of the display as the highlighted area beyond the edge of the document is on the screen. The figure shows that the color of the area beyond the edge could be a solid color similar to the space between information items (*e.g.*, white). *See Ording*, Figures 6-7A.

U.S. Patent No. 7,469,381  
 Issued: December 23, 2008

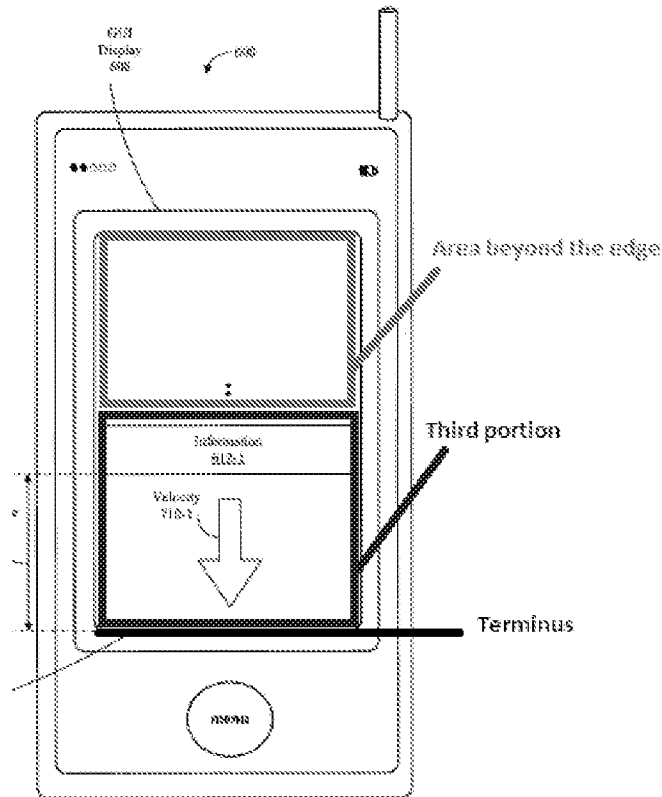

Figure 7A

Thus, *Ording* anticipates claim 13. See Exhibit 6, Part D at 25-26.

**13. Claim 15 should be rejected as anticipated by *Ording***

Claim 15 depends from claim 1, and further requires that “translating the document in the second direction is a damped motion.” *Ording* discloses this feature.

*Ording* discloses that after the direction of scrolling reverses (*i.e.*, translation in a second direction), the scrolling ceases as a result of damped motion. *Ording*, col. 8:47-50.

Additionally, *Ording* discloses that the magnitude of the velocity of translation in the second direction may be damped with respect to (*e.g.*, be less than) the magnitude of the immediately prior velocity in the first direction at the same location on the display. *Ording*, col. 9:29-35.

*Ording* also discloses that the scrolling (*i.e.*, translation) in the second direction may be damped

U.S. Patent No. 7,469,381  
Issued: December 23, 2008

via the simulation of an elastic collision. *Ording*, col. 4:47-56. Thus, *Ording* discloses that translating the document in the second direction is a damped motion.

Thus, *Ording* anticipates claim 15. *See* Exhibit 6, Part D at 27-28.

**14. Claim 16 should be rejected as anticipated by *Ording***

Claim 16 depends from claim 1, and further requires that the “changing from translating in the first direction to translating in the second direction until the area beyond the edge of the document is no longer displayed makes the edge of the electronic document appear to be elastically attached to an edge of the touch screen display or to an edge displayed on the touch screen display.” *Ording* discloses this feature.

As discussed above in connection with limitations 1(d) and (e) (*supra* at 70-75), *Ording* discloses translating in the first direction, followed by translating in the second direction until the area beyond the edge of the document is no longer displayed. *Ording* further discloses that the motion can change from translating in a first direction to translating in a second direction by simulating an elastic collision between a displayed portion of the document and a virtual boundary. *Ording*, col. 4:44-59. One such location-variant, virtual boundary is the terminus that can be placed at the edge of the touch screen display. *Ording*, col. 9:18-21, Figures 7B-C. Furthermore, information objects can be scrolled into the terminus and “bounce.” *Ording*, col. 9:22-35, Figure 7C. Thus, as the beginning/end of the list ( *i.e.*, edge of the electronic document) is translated into a terminus, the bouncing effect gives the impression that the edge of the document is elastically attached to the display edge on the far side of the terminus, since the document will rebound in that direction as if on a rubber-band. Accordingly, the change in translation direction in *Ording* makes the edge of the document appear to be elastically attached to a display edge.

Thus, *Ording* anticipates claim 16. *See* Exhibit 6, Part D at 28.

U.S. Patent No. 7,469,381  
Issued: December 23, 2008

**15. Claim 17 should be rejected as anticipated by *Ording***

*Ording Discloses the preamble of claim 17:* Claim 17 depends from claim 1, and further requires that “translating in the first direction prior to reaching the edge of the electronic document has a first associated translating distance that corresponds to a distance of movement of the object prior to reaching the edge of the electronic document.” *Ording* discloses this feature.

*Ording* discloses that the list of items (*i.e.*, electronic document) may be scrolled when the movement of the finger/point of contact (*i.e.*, object) exceeds a pre-determined displacement threshold, and that the electronic document is scrolled (*i.e.*, translated) in response to the distance of the contact’s movement. *Ording*, col. 7:46-49. Thus, based on the foregoing and on the discussion above pertaining to claim 1(c) (*supra* at 67-70), *Ording* discloses translating the document a first associated distance in the first direction prior to reaching the edge of the electronic document.

Moreover, *Ording* discloses that the first translating distance corresponds to the distance of movement. For example, *Ording* discloses that “scrolling may be in accordance with a speed of movement of the point of contact.” *Ording*, col. 7:6-7. As another example, *Ording* discloses that “[s]crolling of the list is accelerated in response to an accelerated movement of the point of contact.” *Ording*, col. 1:51-55. Thus, since the scrolling speed (or acceleration) corresponds to the speed of movement (or acceleration) of the point of contact (*i.e.*, object), then the resulting translating distance also will correspond to the movement of the object (and therefore its distance).

Thus, *Ording* discloses the preamble of claim 17. *See* Exhibit 6, Part D at 29.

U.S. Patent No. 7,469,381  
Issued: December 23, 2008

Ording Discloses Limitation 17(a): This limitation requires that displaying the area beyond the edge comprises “translating the electronic document in the first direction for a second associated translating distance.” *Ording* discloses this feature.

As discussed above in connection with claim 1(d) (*supra* at 70-72), *Ording* discloses the displaying the area beyond the edge comprises translating the list (*i.e.*, electronic document) in a first direction. *Ording* also discloses that this translation of the electronic document is for a second translating distance that is associated with the direction of translation. More specifically, *Ording* discloses the terminus to be a location-variant virtual boundary. *Ording*, col. 9:18-21. As the beginning/end of the list is moving in the first direction and approaches the terminus, the displayed area beyond the edge of the list (*i.e.*, electronic document) grows in relation to the size of the list’s displayed area. *See, Ording*, Figures 7A-C. As Figure 7B illustrates, when the terminus is at the bottom edge of the display, the second associated translating distance will be longer, the area the area beyond the edge of the document will encompass most of the display, and the document display itself is left with the smaller remainder. However, when the terminus is placed in the middle of the display, the second associated translating distance will be shorter, and the displayed area of the document will be approximately equal to the area beyond the edge. Thus, the document can be translated for a second associated distance that is dependent on the placement of the terminus.

Thus, *Ording* discloses limitation 17(a). *See* Exhibit 6, Part D at 29-31.

Ording Discloses Limitation 17(b): This limitation requires that “the second associated translating distance is less than a distance of movement of the object after reaching the edge of the electronic document.” *Ording* discloses this feature.

U.S. Patent No. 7,469,381  
Issued: December 23, 2008

As discussed above in connection with claim 12 (*supra* at 79), *Ording* discloses motion damping that can alter the relationship between scrolling and user movement input. *Ording* discloses that “the scrolling and acceleration of the scrolling may be in accordance with a simulation of a physical device having friction, *i.e.*, damped motion,” by using motion equations having mass, inertial and dissipative (*i.e.*, frictional) terms. *Ording*, col. 4:6-12. Moreover, *Ording* discloses that these frictional terms are adjustable. *Ording*, col. 4:54-59. If one of these frictional terms is adjusted, then either additional or less user input would be required to achieve the same scrolling output. If the adjustment is made to increase any of these terms such that more user input is required, then a given finger movement distance will result in a smaller associated translating distance. Increasing these frictional terms as taught by *Ording* as the edge of the document is reached would require more user input to translate the list (*i.e.*, electronic document) and results in having the (second) translating distance be less than the distance of movement of the finger (*i.e.*, object).

Thus, *Ording* discloses limitation 17(b). *See* Exhibit 6, Part D at 32.

In view of the foregoing, *Ording* anticipates claim 17.

**16. Claim 18 should be rejected as anticipated by *Ording***

*Ording Discloses the preamble of claim 18:* Claim 18 depends from claim 1, and further requires that “translating in the first direction prior to reaching the edge of the electronic document has a first associated translating speed that corresponds to a speed of movement of the object.” *Ording* discloses this feature.

*Ording* discloses that the list of items (*i.e.*, electronic document) may be scrolled when the movement of the finger/point of contact (*i.e.*, object) exceeds a pre-determined displacement threshold, and that the electronic document is scrolled (*i.e.*, translated). *Ording*, col. 7:46-49. *Ording* further discloses the electronic document is scrolled (*i.e.*, translated) at a certain speed.



U.S. Patent No. 7,469,381  
Issued: December 23, 2008

*Ording*, col. 7:6-7. Thus, based on the foregoing and on the discussion above pertaining to claim 1(c) (*supra* at 67-70), *Ording* discloses translating the document in the first direction prior to reaching the edge of the electronic document at a first associated translating speed.

Moreover, *Ording* discloses that the first translating speed corresponds to the speed of movement of the finger/point of contact (*i.e.*, object). For example, *Ording* discloses that “scrolling may be in accordance with a speed of movement of the point of contact.” *Ording*, col. 7:6-7.

Thus, *Ording* discloses the preamble of claim 18. *See* Exhibit 6, Part D at 32-33.

*Ording* Discloses Limitation 18(a)-(b): Limitation 18(a) requires that displaying the area beyond the edge comprises “translating the electronic document in the first direction at a second associated translating speed.” Limitation 18(b) requires that the “second associated translating speed is slower than the first associated translating speed.” *Ording* discloses these features.

*Ording* discloses translating the document at a second speed that is slower than the first translating speed. For example, *Ording*, discloses that “[i]n some embodiments... the velocity of the scrolling may be tapered.” *Ording*, col. 7:35-42. Thus, as the document continues to scroll in the first direction, the translation speed will decrease.

Thus, *Ording* discloses limitations 18(a) and 18(b). *See* Exhibit 6, Part D at 33.

In view of the foregoing, *Ording* anticipates claim 18.

## VII. CONCLUSION

For at least the reasons set forth above, it is clear that substantial new questions of patentability have been raised against claims 1-20 of the ‘381 Patent. Therefore, it is requested that this request for reexamination be granted and that claims 1-20 be rejected.

U.S. Patent No. 7,469,381  
Issued: December 23, 2008

As identified in the attached Certificate of Service and in accordance with 37 C.F.R. §§ 1.33(c) and 1.510(b)(5), a copy of the present request, in its entirety, is being served to the address of the attorney or agent of record.

I hereby certify that this correspondence is being transmitted in accordance with 37 CFR §§1.6(a)(4) and 1.8 via the U.S. Patent and Trademark Office (USPTO) electronic filing system (EFS-Web) to: Mail Stop *Ex Parte* Reexam, Commissioner For Patents, P.O. Box 1450, Alexandria, VA 22313-1450, on May 23, 2012.

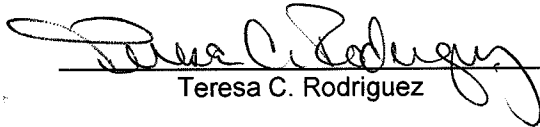
  
Teresa C. Rodriguez

Respectfully submitted,

By:

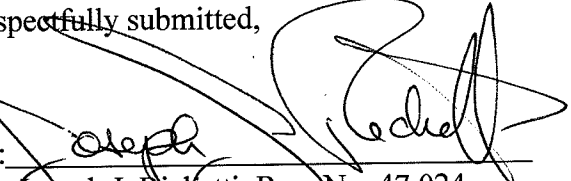
  
Joseph J. Richetti, Reg. No. 47,024  
BRYAN CAVELL P  
1290 Avenue of the Americas  
New York, New York 10104  
Tel. No. (212) 541-2000  
Fax. No. (212) 541-4630

U.S. Patent No. 7,469,381  
Issued: December 23, 2008

**CERTIFICATE OF SERVICE**

I hereby certify that a copy of this REQUEST FOR *EX PARTE* REEXAMINATION has been served in its entirety on the patent owner as provided in 37 C.F.R. § 1.33(c) by being deposited on this date with the U.S. Postal Service in an envelope as "Express Mail Post Office to Addressee" Mailing Label Number EB 780378155 US addressed to:

Morgan Lewis & Bockius LLP  
2 Palo Alto Square  
3000 El Camino Real, Suite 700  
Palo Alto, CA 94306

Date of Service: May 23, 2012

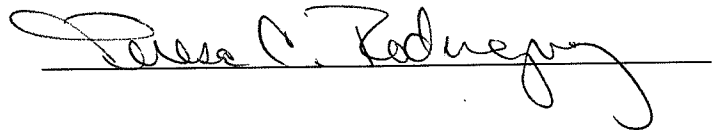
A handwritten signature in black ink, reading "Teresa C. Rodriguez", is written over a horizontal line.

Under the Paperwork Reduction Act of 1995, no persons are required to respond to a collection of information unless it displays a valid OMB control number.

(Also referred to as FORM PTO-1465)

**REQUEST FOR *EX PARTE* REEXAMINATION TRANSMITTAL FORM**

Address to:

**Mail Stop *Ex Parte* Reexam  
Commissioner for Patents  
P.O. Box 1450  
Alexandria, VA 22313-1450**Attorney Docket No.: 0331834.381Date: May 23, 2012

1.  This is a request for *ex parte* reexamination pursuant to 37 CFR 1.510 of patent number 7,469,381 issued December 23, 2008. The request is made by:  
 patent owner.  third party requester.
2.  The name and address of the person requesting reexamination is:  
Joseph J. Richetti  
BRYAN CAVE LLP  
1290 Avenue of the Americas, New York, NY 10104
3.  a. A check in the amount of \$\_\_\_\_\_ is enclosed to cover the reexamination fee, 37 CFR 1.20(c)(1);  
 b. The Director is hereby authorized to charge the fee as set forth in 37 CFR 1.20(c)(1) to Deposit Account No. 02-4467; or  
 c. Payment by credit card. Form PTO-2038 is attached.
4.  Any refund should be made by  check or  credit to Deposit Account No. \_\_\_\_\_ 37 CFR 1.26(c). If payment is made by credit card, refund must be to credit card account.
5.  A copy of the patent to be reexamined having a double column format on one side of a separate paper is enclosed. 37 CFR 1.510(b)(4)
6.  CD-ROM or CD-R in duplicate, Computer Program (Appendix) or large table  
 Landscape Table on CD
7.  Nucleotide and/or Amino Acid Sequence Submission  
*If applicable, items a. – c. are required.*  
a.  Computer Readable Form (CRF)  
b. Specification Sequence Listing on:  
i.  CD-ROM (2 copies) or CD-R (2 copies); or  
ii.  paper  
c.  Statements verifying identity of above copies
8.  A copy of any disclaimer, certificate of correction or reexamination certificate issued in the patent is included.
9.  Reexamination of claim(s) 1-20 is requested.
10.  A copy of every patent or printed publication relied upon is submitted herewith including a listing thereof on Form PTO/SB/08, PTO-1449, or equivalent.
11.  An English language translation of all necessary and pertinent non-English language patents and/or printed publications is included.

[Page 1 of 2]

This collection of information is required by 37 CFR 1.510. The information is required to obtain or retain a benefit by the public which is to file (and by the USPTO to process) an application. Confidentiality is governed by 35 U.S.C. 122 and 37 CFR 1.11 and 1.14. This collection is estimated to take 18 minutes to complete, including gathering, preparing, and submitting the completed application form to the USPTO. Time will vary depending upon the individual case. Any comments on the amount of time you require to complete this form and/or suggestions for reducing this burden, should be sent to the Chief Information Officer, U.S. Patent and Trademark Office, U.S. Department of Commerce, P.O. Box 1450, Alexandria, VA 22313-1450. DO NOT SEND FEES OR COMPLETED FORMS TO THIS ADDRESS. **SEND TO: Mail Stop *Ex Parte* Reexam, Commissioner for Patents, P.O. Box 1450, Alexandria, VA 22313-1450.**

*If you need assistance in completing the form, call 1-800-PTO-9199 and select option 2.*

Under the Paperwork Reduction Act of 1995, no persons are required to respond to a collection of information unless it displays a valid OMB control number.

12.  The attached detailed request includes at least the following items:
- a. A statement identifying each substantial new question of patentability based on prior patents and printed publications. 37 CFR 1.510(b)(1)
  - b. An identification of every claim for which reexamination is requested, and a detailed explanation of the pertinency and manner of applying the cited art to every claim for which reexamination is requested. 37 CFR 1.510(b)(2).
13.  A proposed amendment is included (only where the patent owner is the requester). 37 CFR 1.510(e)
14.  a. It is certified that a copy of this request (if filed by other than the patent owner) has been served in its entirety on the patent owner as provided in 37 CFR 1.33(c).  
 The name and address of the party served and the date of service are:  
MORGAN LEWIS & BOCKIUS LLP  
2 Palo Alto Square, 3000 El Camino Real, Suite 700  
Palo Alto, CA 94306  
 Date of Service: May 23, 2012; or
- b. A duplicate copy is enclosed because service on patent owner was not possible. An explanation of the efforts made to serve patent owner **is attached**. See MPEP 2220.

15. Correspondence Address: Direct all communications about the reexamination to:

The address associated with Customer Number:

83559

**OR**

Firm or Individual Name \_\_\_\_\_

Address

City

State

Zip

Country

Telephone

Email

16.  The patent is currently the subject of the following concurrent proceeding(s):

- a. Copending reissue Application No. \_\_\_\_\_
- b. Copending reexamination Control No. \_\_\_\_\_
- c. Copending Interference No. \_\_\_\_\_
- d. Copending litigation styled: \_\_\_\_\_

**WARNING: Information on this form may become public. Credit card information should not be included on this form. Provide credit card information and authorization on PTO-2038.**

/Joseph J. Richetti, Reg. No. 47024/

May 23, 2012

Authorized Signature

Date

Joseph J. Richetti

47,024

For Patent Owner Requester

Typed/Printed Name

Registration No.

For Third Party Requester

## Privacy Act Statement

The **Privacy Act of 1974 (P.L. 93-579)** requires that you be given certain information in connection with your submission of the attached form related to a patent application or patent. Accordingly, pursuant to the requirements of the Act, please be advised that: (1) the general authority for the collection of this information is 35 U.S.C. 2(b)(2); (2) furnishing of the information solicited is voluntary; and (3) the principal purpose for which the information is used by the U.S. Patent and Trademark Office is to process and/or examine your submission related to a patent application or patent. If you do not furnish the requested information, the U.S. Patent and Trademark Office may not be able to process and/or examine your submission, which may result in termination of proceedings or abandonment of the application or expiration of the patent.

The information provided by you in this form will be subject to the following routine uses:

1. The information on this form will be treated confidentially to the extent allowed under the Freedom of Information Act (5 U.S.C. 552) and the Privacy Act (5 U.S.C. 552a). Records from this system of records may be disclosed to the Department of Justice to determine whether disclosure of these records is required by the Freedom of Information Act.
2. A record from this system of records may be disclosed, as a routine use, in the course of presenting evidence to a court, magistrate, or administrative tribunal, including disclosures to opposing counsel in the course of settlement negotiations.
3. A record in this system of records may be disclosed, as a routine use, to a Member of Congress submitting a request involving an individual, to whom the record pertains, when the individual has requested assistance from the Member with respect to the subject matter of the record.
4. A record in this system of records may be disclosed, as a routine use, to a contractor of the Agency having need for the information in order to perform a contract. Recipients of information shall be required to comply with the requirements of the Privacy Act of 1974, as amended, pursuant to 5 U.S.C. 552a(m).
5. A record related to an International Application filed under the Patent Cooperation Treaty in this system of records may be disclosed, as a routine use, to the International Bureau of the World Intellectual Property Organization, pursuant to the Patent Cooperation Treaty.
6. A record in this system of records may be disclosed, as a routine use, to another federal agency for purposes of National Security review (35 U.S.C. 181) and for review pursuant to the Atomic Energy Act (42 U.S.C. 218(c)).
7. A record from this system of records may be disclosed, as a routine use, to the Administrator, General Services, or his/her designee, during an inspection of records conducted by GSA as part of that agency's responsibility to recommend improvements in records management practices and programs, under authority of 44 U.S.C. 2904 and 2906. Such disclosure shall be made in accordance with the GSA regulations governing inspection of records for this purpose, and any other relevant (*i.e.*, GSA or Commerce) directive. Such disclosure shall not be used to make determinations about individuals.
8. A record from this system of records may be disclosed, as a routine use, to the public after either publication of the application pursuant to 35 U.S.C. 122(b) or issuance of a patent pursuant to 35 U.S.C. 151. Further, a record may be disclosed, subject to the limitations of 37 CFR 1.14, as a routine use, to the public if the record was filed in an application which became abandoned or in which the proceedings were terminated and which application is referenced by either a published application, an application open to public inspection or an issued patent.
9. A record from this system of records may be disclosed, as a routine use, to a Federal, State, or local law enforcement agency, if the USPTO becomes aware of a violation or potential violation of law or regulation.



(12) **United States Patent  
Ording**

(10) **Patent No.: US 7,469,381 B2**  
(45) **Date of Patent: Dec. 23, 2008**

(54) **LIST SCROLLING AND DOCUMENT TRANSLATION, SCALING, AND ROTATION ON A TOUCH-SCREEN DISPLAY** 6,489,951 B1 12/2002 Wong et al. .... 345/173  
6,567,102 B2 5/2003 Kung ..... 345/660

(75) Inventor: **Bas Ording**, San Francisco, CA (US)

(Continued)

(73) Assignee: **Apple Inc.**, Cupertino, CA (US)

FOREIGN PATENT DOCUMENTS

(\* ) Notice: Subject to any disclaimer, the term of this patent is extended or adjusted under 35 U.S.C. 154(b) by 0 days. EP 0 635 779 A1 1/1995

(21) Appl. No.: **11/956,969**

(Continued)

(22) Filed: **Dec. 14, 2007**

OTHER PUBLICATIONS

(65) **Prior Publication Data**

US 2008/0168404 A1 Jul. 10, 2008

Microsoft Word 2003 Screen Shots.\*

(Continued)

**Related U.S. Application Data**

(60) Provisional application No. 60/937,993, filed on Jun. 29, 2007, provisional application No. 60/946,971, filed on Jun. 28, 2007, provisional application No. 60/945,858, filed on Jun. 22, 2007, provisional application No. 60/879,469, filed on Jan. 8, 2007, provisional application No. 60/883,801, filed on Jan. 7, 2007, provisional application No. 60/879,253, filed on Jan. 7, 2007.

*Primary Examiner*—Boris Pesin  
(74) *Attorney, Agent, or Firm*—Morgan, Lewis & Bockius LLP

(57) **ABSTRACT**

In accordance with some embodiments, a computer-implemented method for use in conjunction with a device with a touch screen display is disclosed. In the method, a movement of an object on or near the touch screen display is detected. In response to detecting the movement, an electronic document displayed on the touch screen display is translated in a first direction. If an edge of the electronic document is reached while translating the electronic document in the first direction while the object is still detected on or near the touch screen display, an area beyond the edge of the document is displayed. After the object is no longer detected on or near the touch screen display, the document is translated in a second direction until the area beyond the edge of the document is no longer displayed.

(51) **Int. Cl.**  
**G06F 3/01** (2006.01)

(52) **U.S. Cl.** ..... **715/702**; 715/764; 715/863; 715/864; 715/769

(58) **Field of Classification Search** ..... 715/764, 715/769, 702, 863, 864  
See application file for complete search history.

(56) **References Cited**

U.S. PATENT DOCUMENTS

5,495,566 A 2/1996 Kwatinetz ..... 395/157  
5,844,547 A 12/1998 Minakuchi et al. .... 345/173  
5,867,158 A 2/1999 Murasaki et al. .... 345/341  
6,034,688 A 3/2000 Greenwood et al. .... 345/353

**20 Claims, 38 Drawing Sheets**

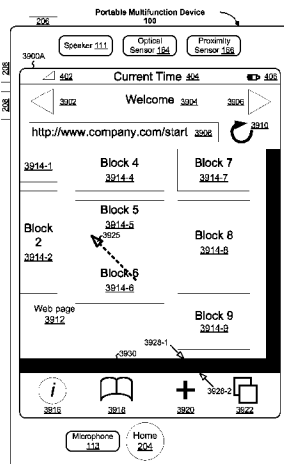

## US 7,469,381 B2

Page 2

## U.S. PATENT DOCUMENTS

6,661,409	B2	12/2003	Demartines et al. ....	345/173
6,690,387	B2*	2/2004	Zimmerman et al. ....	345/684
6,707,449	B2	3/2004	Hinckley et al. ....	345/173
6,809,724	B1	10/2004	Shiraishi et al. ....	345/169
6,907,575	B2	6/2005	Duarte ..... 715/784	
6,912,462	B2	6/2005	Ogaki ..... 701/208	
6,972,776	B2	12/2005	Davis et al. ....	345/684
6,975,306	B2	12/2005	Hinckley et al. ....	345/173
7,009,599	B2	3/2006	Pihlaja ..... 345/173	
7,046,230	B2	5/2006	Zadesky et al. ....	345/156
7,075,512	B1	7/2006	Fabre et al. ....	345/156
7,102,626	B2	9/2006	Denny, III ..... 345/179	
7,154,534	B2	12/2006	Seki et al. ....	348/207.1
7,155,048	B2	12/2006	Ohara ..... 382/132	
7,181,373	B2	2/2007	Le Cocq et al. ....	703/1
7,184,796	B2	2/2007	Karidis et al. ....	455/566
7,240,291	B2	7/2007	Card et al. ....	715/776
2003/0095135	A1	5/2003	Kaasila et al. ....	345/613
2003/0095697	A1	5/2003	Wood et al. ....	382/131
2003/0184525	A1	10/2003	Tsai ..... 345/173	
2004/0021676	A1	2/2004	Chen et al. ....	345/684
2004/0027398	A1*	2/2004	Jaeger ..... 345/863	
2004/0080541	A1	4/2004	Saiga et al. ....	345/805
2004/0155888	A1	8/2004	Padgitt et al. ....	345/619
2004/0263486	A1	12/2004	Seni ..... 345/173	
2005/0012723	A1	1/2005	Pallakoff ..... 345/173	
2005/0145807	A1	7/2005	Lapstun et al. ....	250/566
2005/0168488	A1	8/2005	Montague ..... 345/659	
2005/0198588	A1	9/2005	Lin et al. ....	715/784
2005/0237308	A1	10/2005	Autio et al. ....	345/173
2005/0270269	A1	12/2005	Tokkonen ..... 345/156	
2005/0275618	A1	12/2005	Juh et al. ....	345/156
2006/0025218	A1	2/2006	Hotta ..... 463/37	
2006/0026521	A1	2/2006	Hotelling et al. ....	715/702
2006/0048073	A1	3/2006	Jarrett et al. ....	715/784
2006/0055669	A1	3/2006	Das ..... 345/156	
2006/0061551	A1	3/2006	Fateh ..... 345/158	
2006/0077544	A1	4/2006	Stark ..... 359/448	
2006/0082549	A1	4/2006	Hoshino et al. ....	345/157
2006/0094502	A1	5/2006	Katayama et al. ....	463/31
2006/0156249	A1	7/2006	Blythe et al. ....	715/781
2006/0181510	A1	8/2006	Faith ..... 345/158	
2006/0187215	A1	8/2006	Rosenberg et al. ....	345/173
2006/0197753	A1	9/2006	Hotelling ..... 345/173	
2006/0238495	A1	10/2006	Davis ..... 345/156	
2007/0008066	A1	1/2007	Fukuda ..... 340/5.52	
2007/0024646	A1	2/2007	Saarinen et al. ....	345/660
2007/0046646	A1	3/2007	Kwon et al. ....	345/173
2007/0067745	A1	3/2007	Choi et al. ....	715/863
2007/0109275	A1	5/2007	Chuang ..... 345/173	
2007/0120835	A1	5/2007	Sato ..... 345/173	
2007/0150826	A1	6/2007	Anzures et al. ....	715/772
2007/0150842	A1	6/2007	Chaudhri et al. ....	715/863
2007/0152978	A1	7/2007	Kocienda et al. ....	345/173
2007/0152979	A1	7/2007	Jobs et al. ....	345/173
2007/0155434	A1	7/2007	Jobs et al. ....	455/565
2007/0156364	A1	7/2007	Rothkopf ..... 702/117	
2008/0104544	A1*	5/2008	Collins et al. ....	715/846

## FOREIGN PATENT DOCUMENTS

EP	0 701 220	A	3/1996
EP	0 880 091	A2	11/1998
WO	WO 02/01338	A1	1/2002
WO	WO 03/060622	A2	7/2003
WO	WO 2005/052773	A2	6/2005
WO	WO 2006/003591	A	1/2006
WO	WO 2006/020305	A2	2/2006

## OTHER PUBLICATIONS

Photo Mesa 3.1.2 2006 Screen Shots.\*  
International Search Report and Written Opinion for International Application No. PCT/US2008/050292, mailed Sep. 19, 2008.  
IBM, "Scroll Control Box," IBM Technical Disclosure Bulletin, vol. 38, No. 04, Apr. 1993, pp. 399-403.  
Tidwell et al., "Magnetism," Designing Interfaces, Nov. 2005, Section 85.  
Invitation to Pay Additional Fees for International Application No. PCT/US2008/050292, mailed Jul. 18, 2008.  
Miller, D., "PersonalJava Application Environment," Sun Microsystems, <http://java.sun.com/products/personaljava/touchable/>, Jun. 8, 1999, 13 pages.

\* cited by examiner



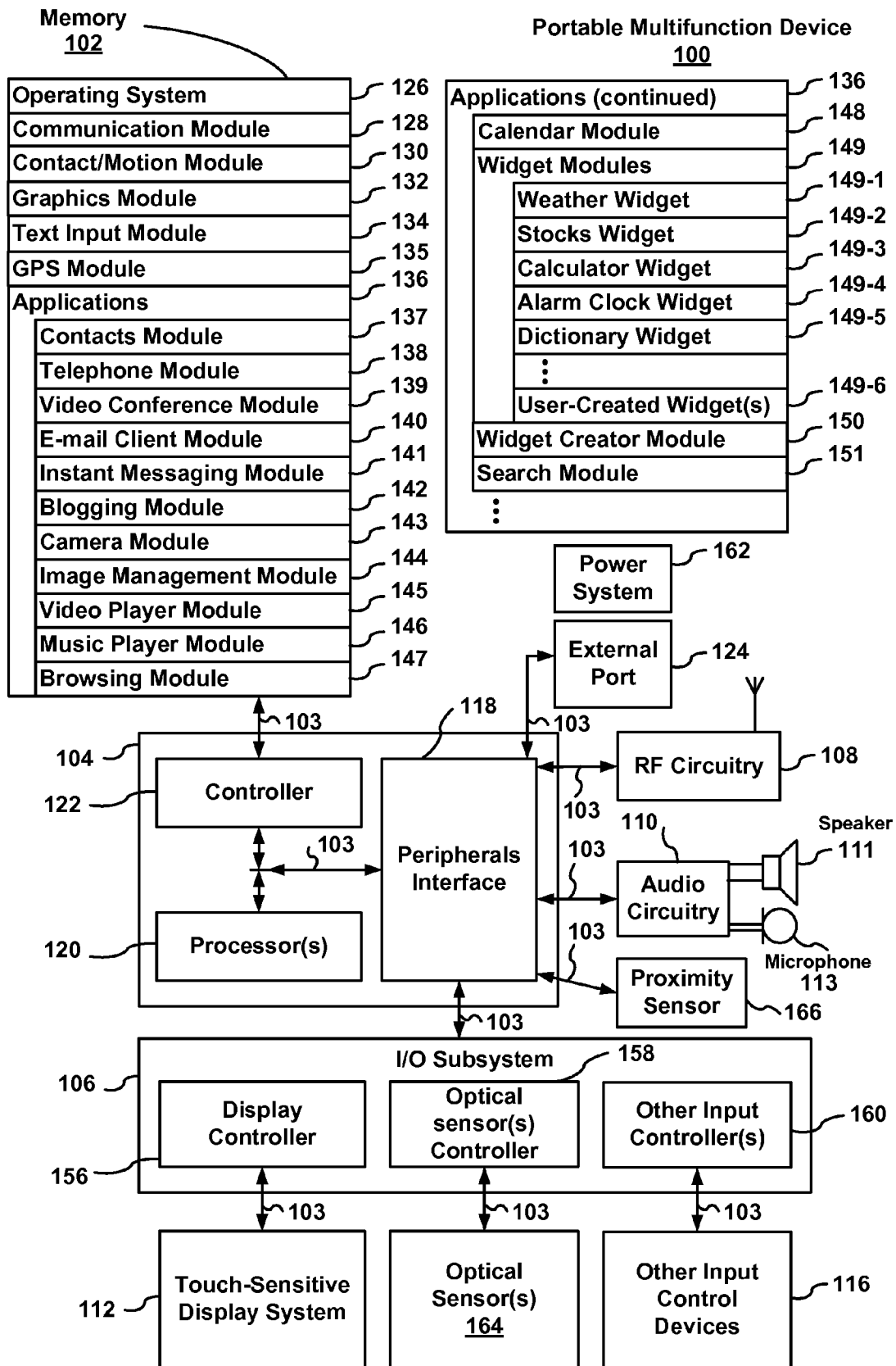

Figure 1

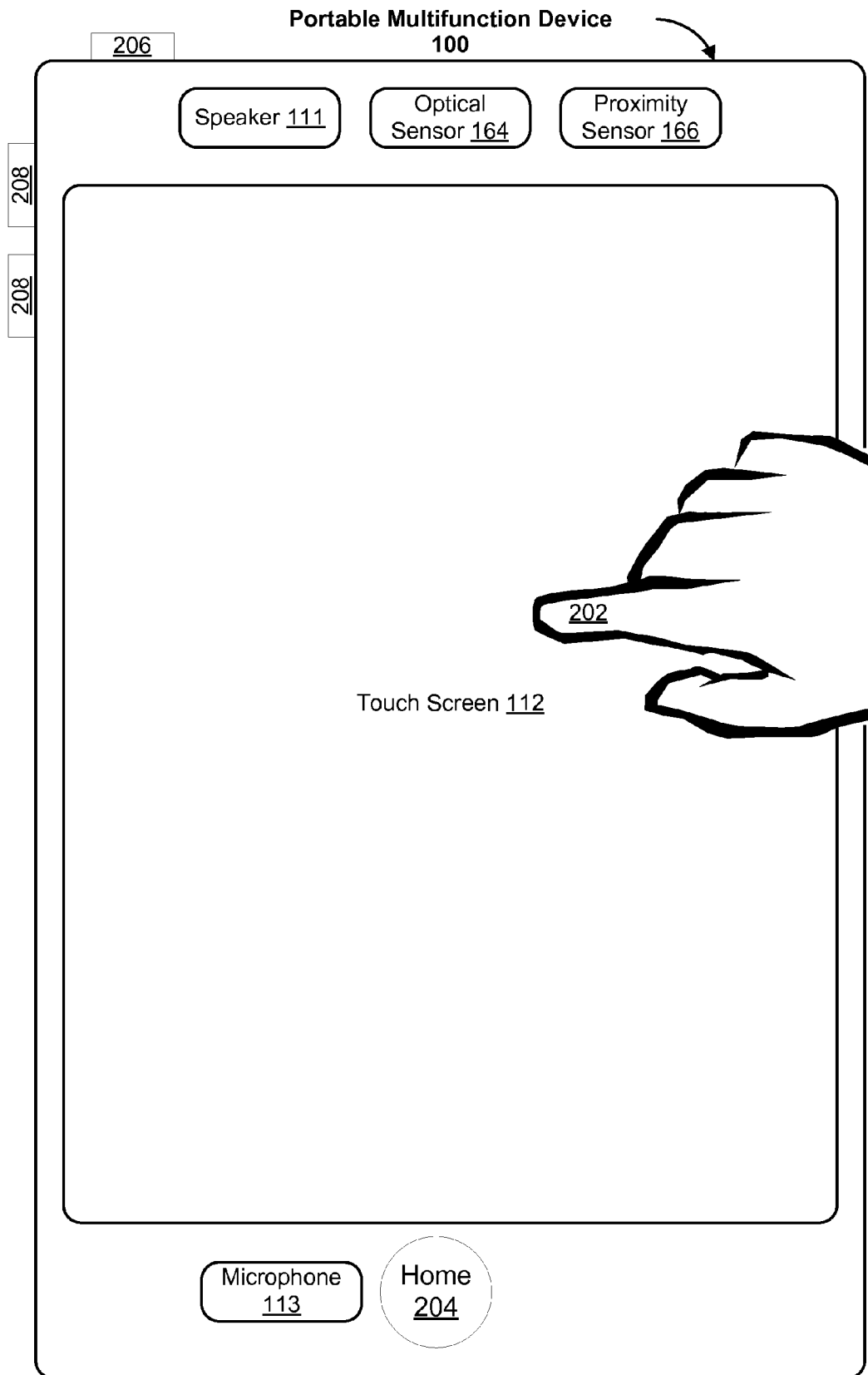

Figure 2

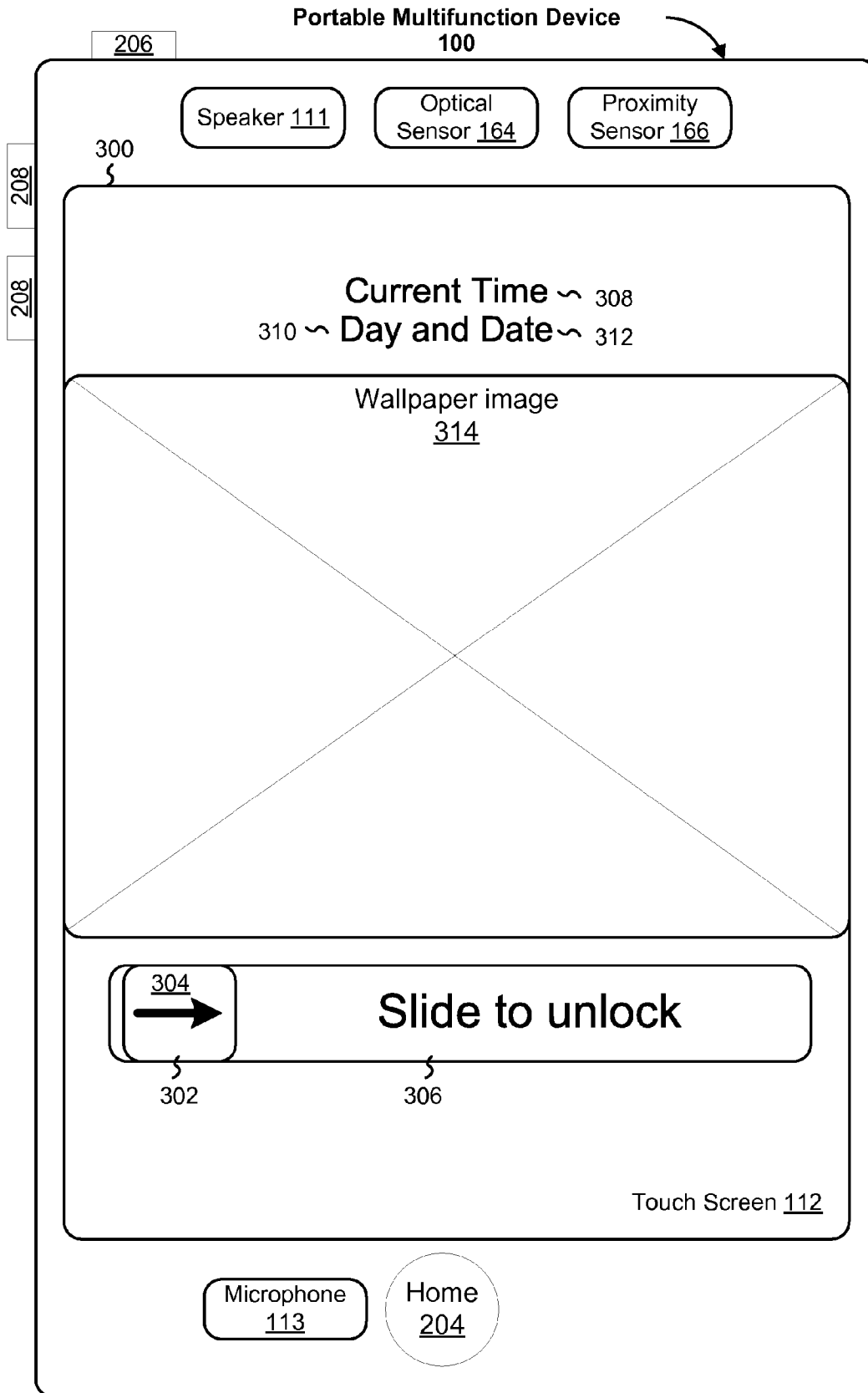

Figure 3

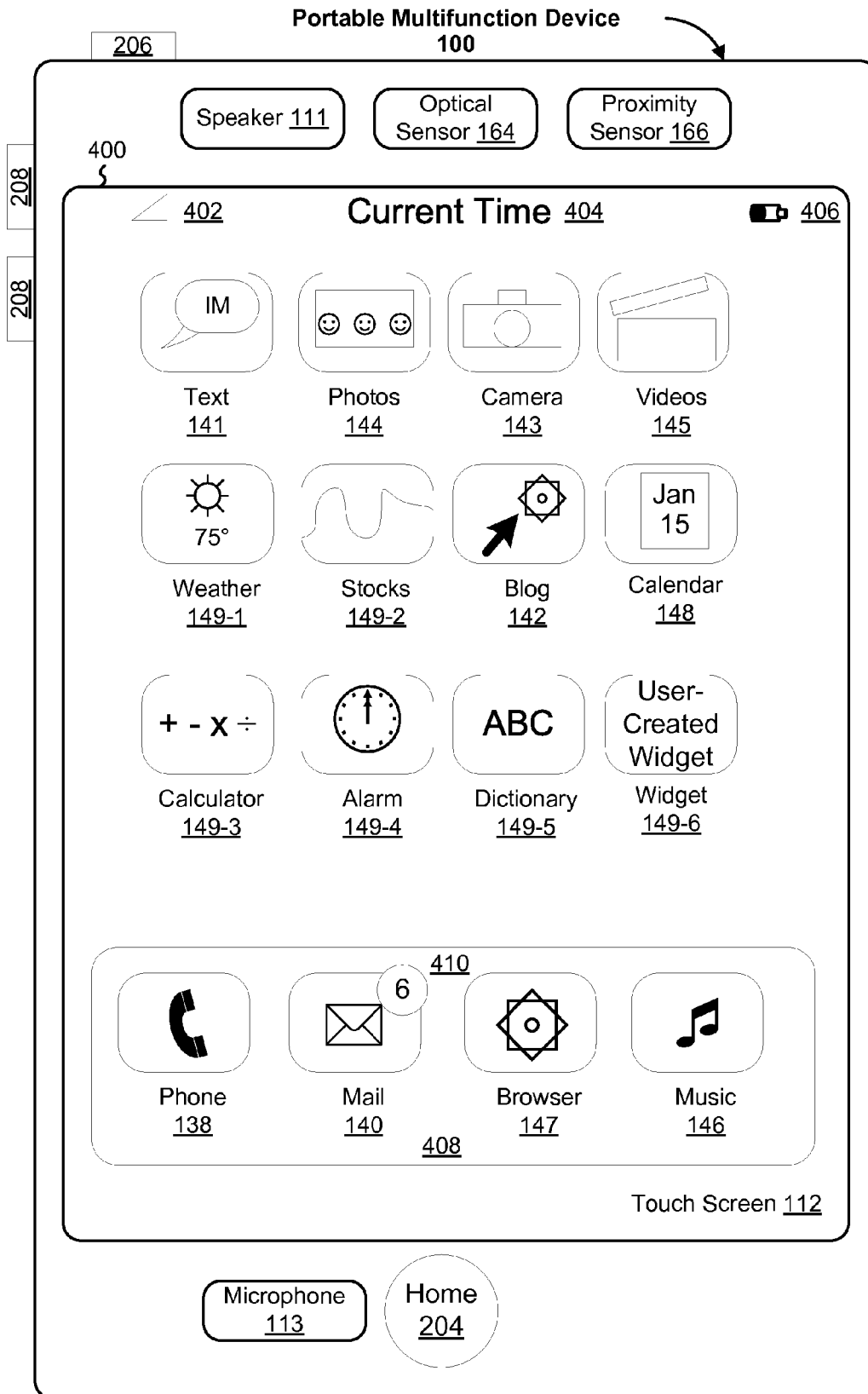

Figure 4

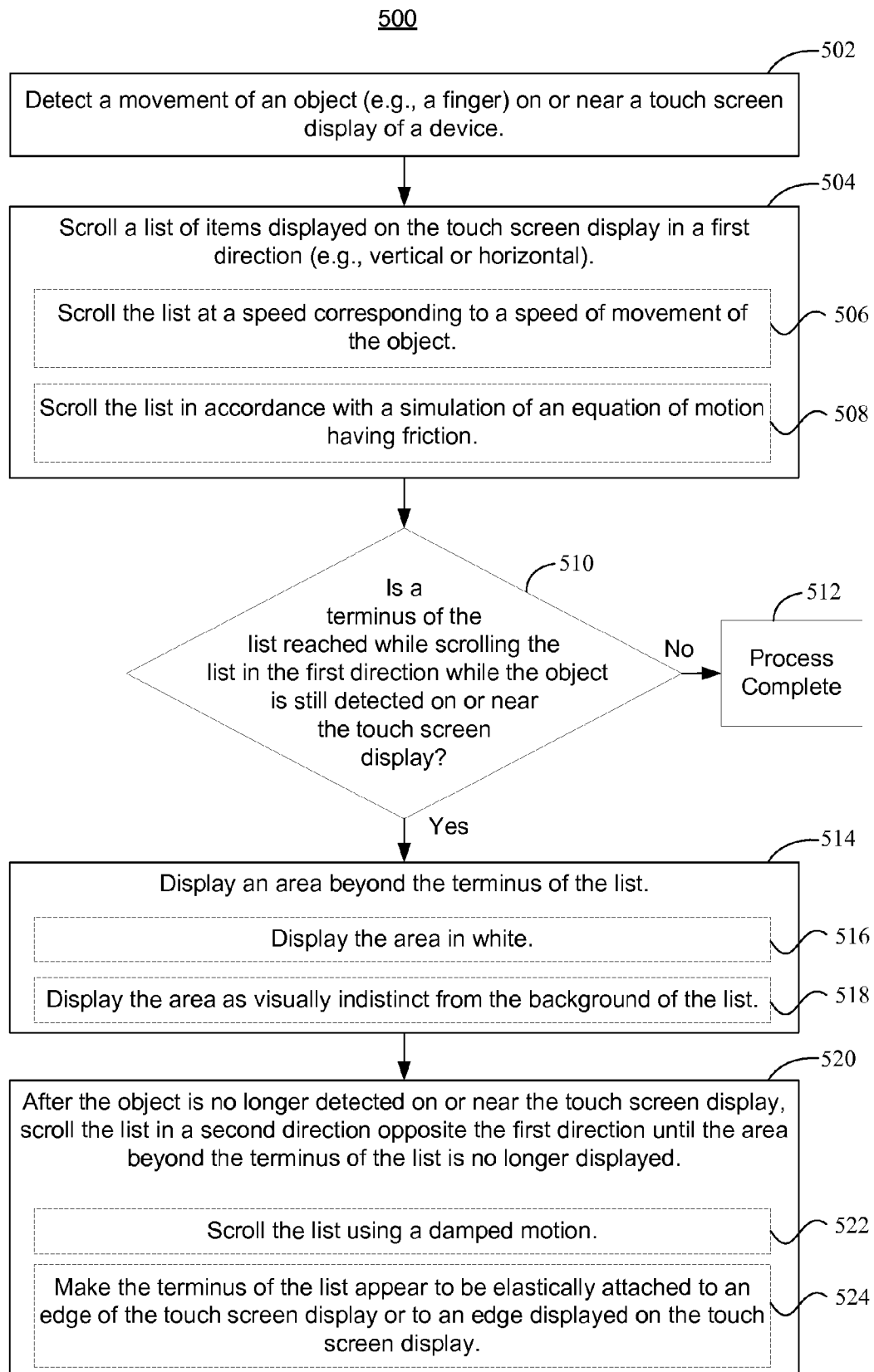

Figure 5

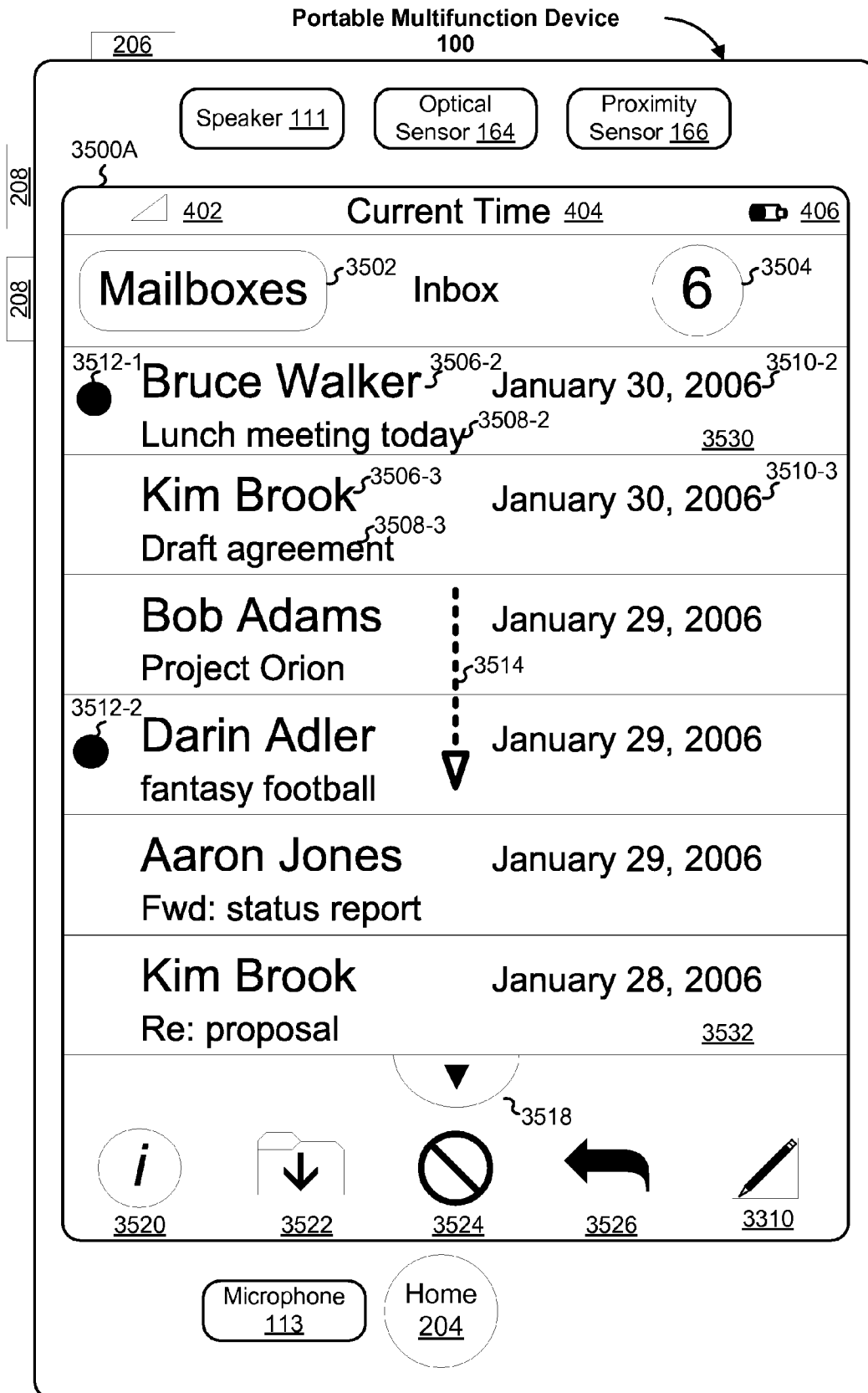

Figure 6A

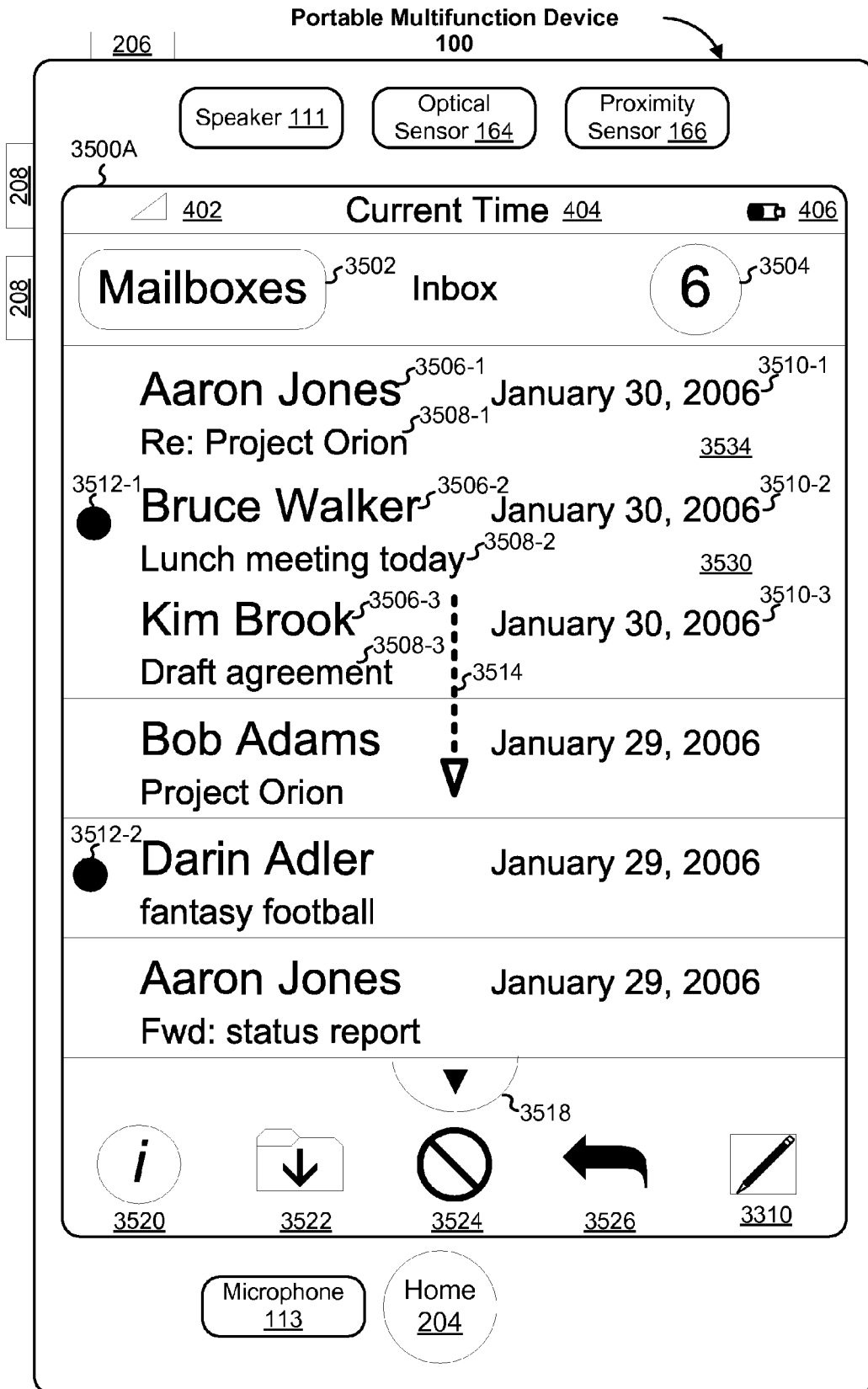

Figure 6B

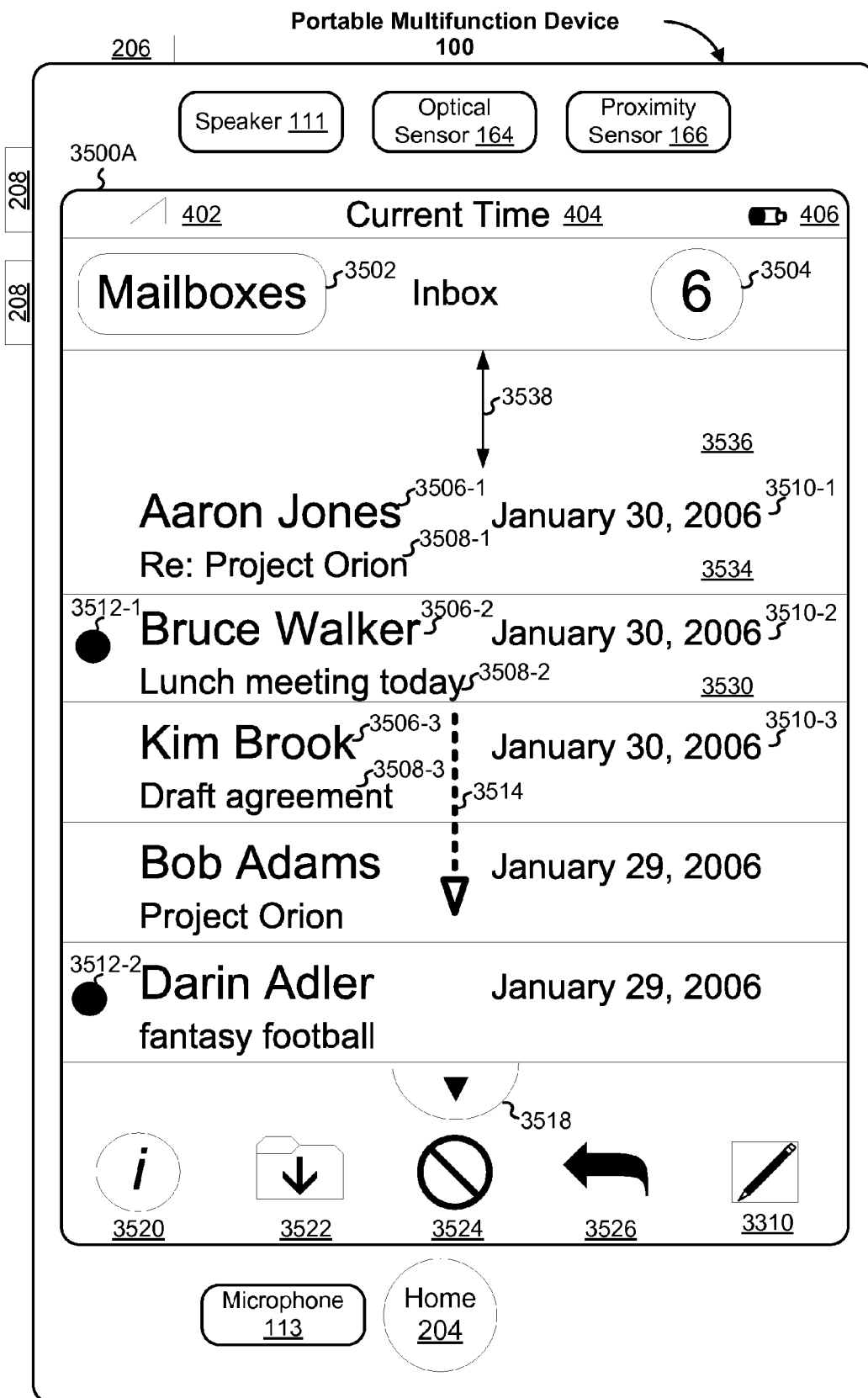

Figure 6C



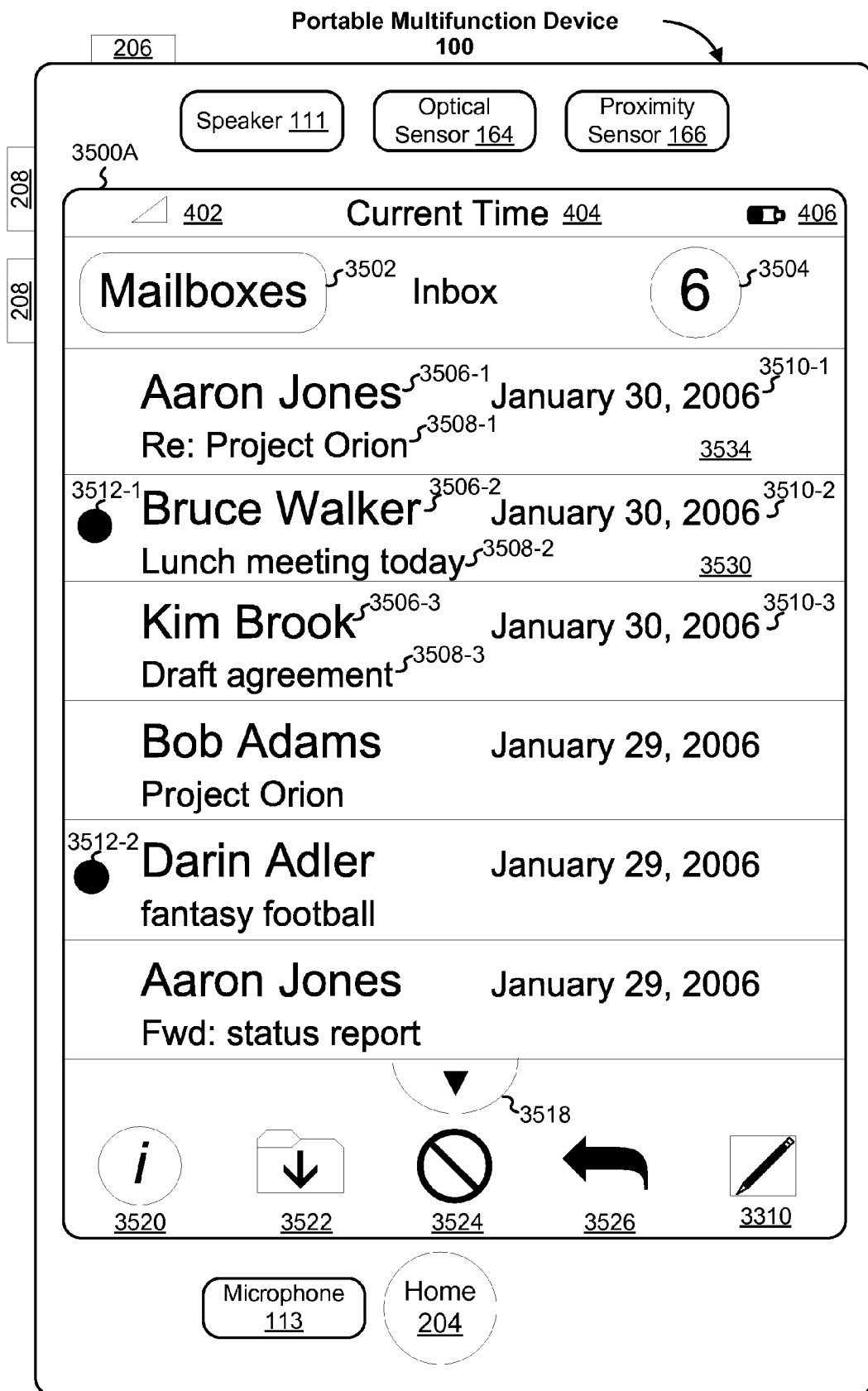

Figure 6D

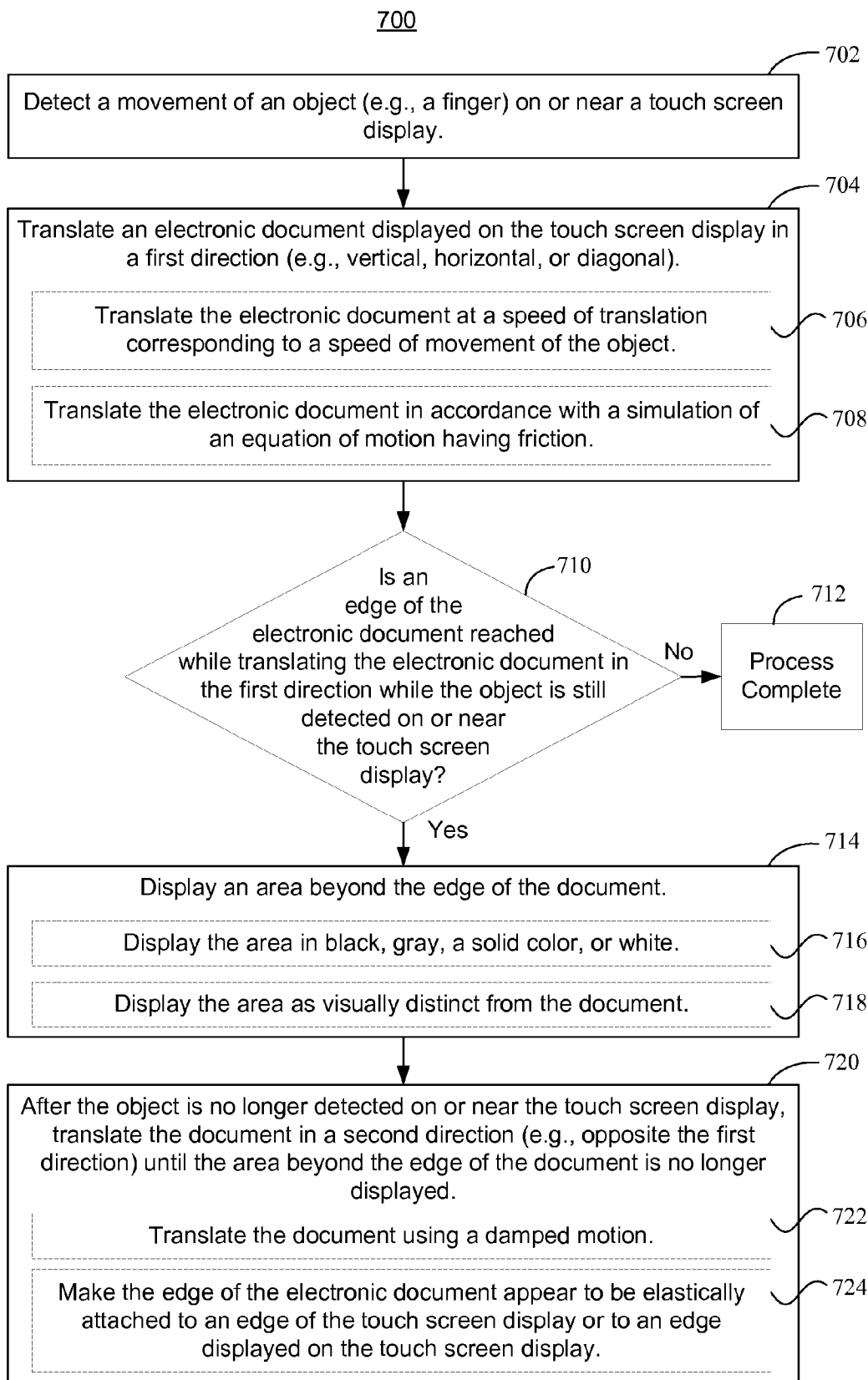

Figure 7

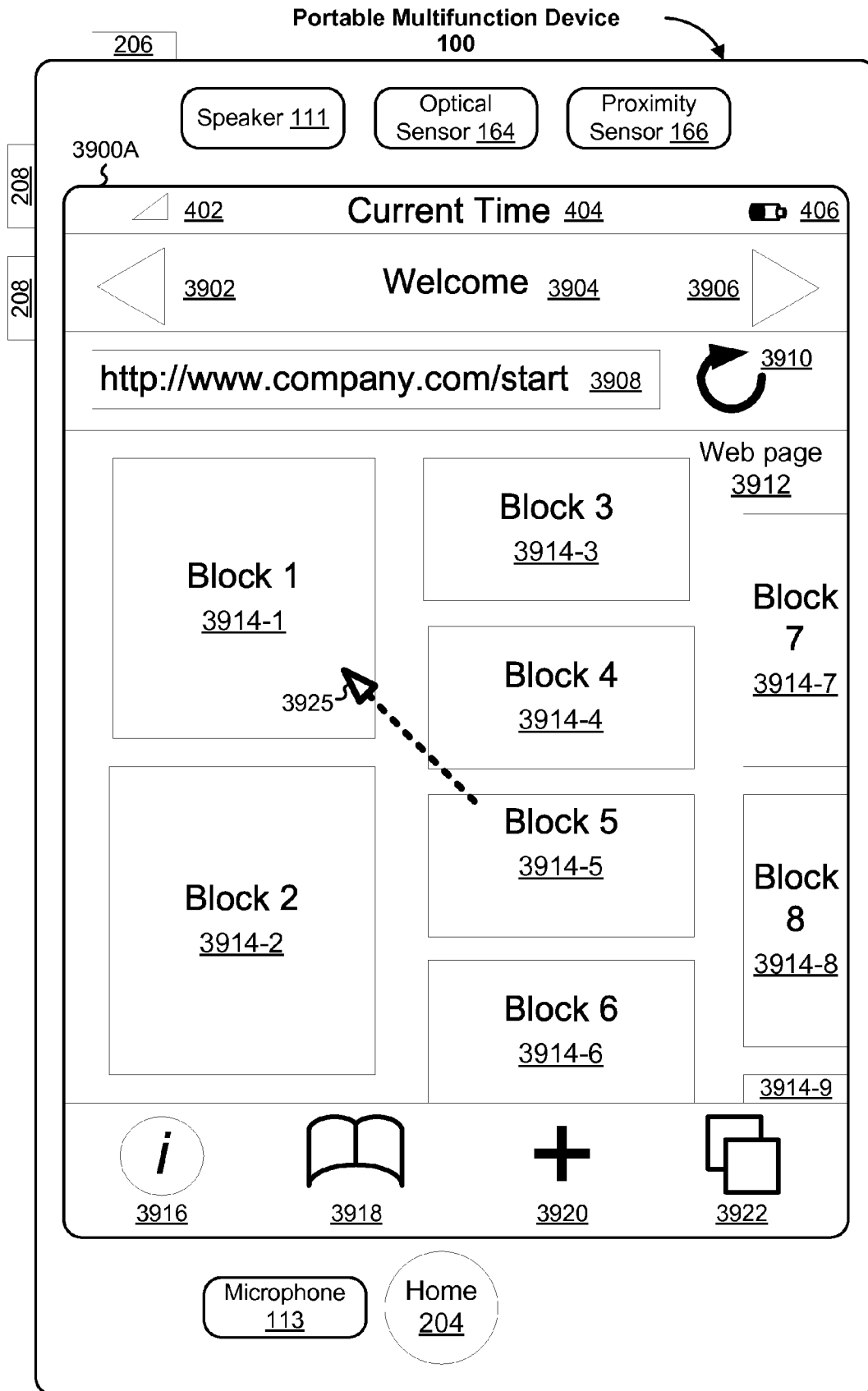

Figure 8A

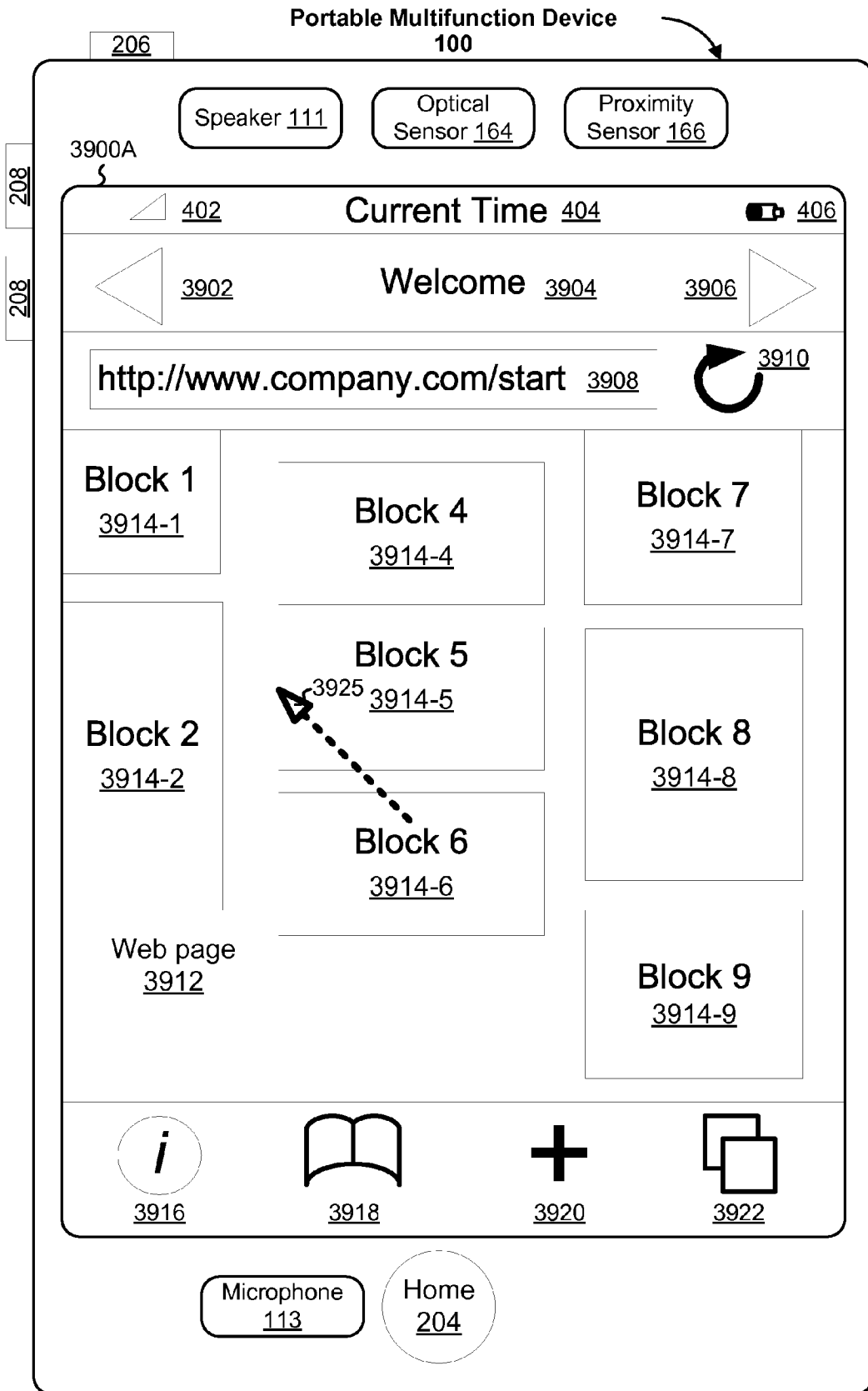

Figure 8B

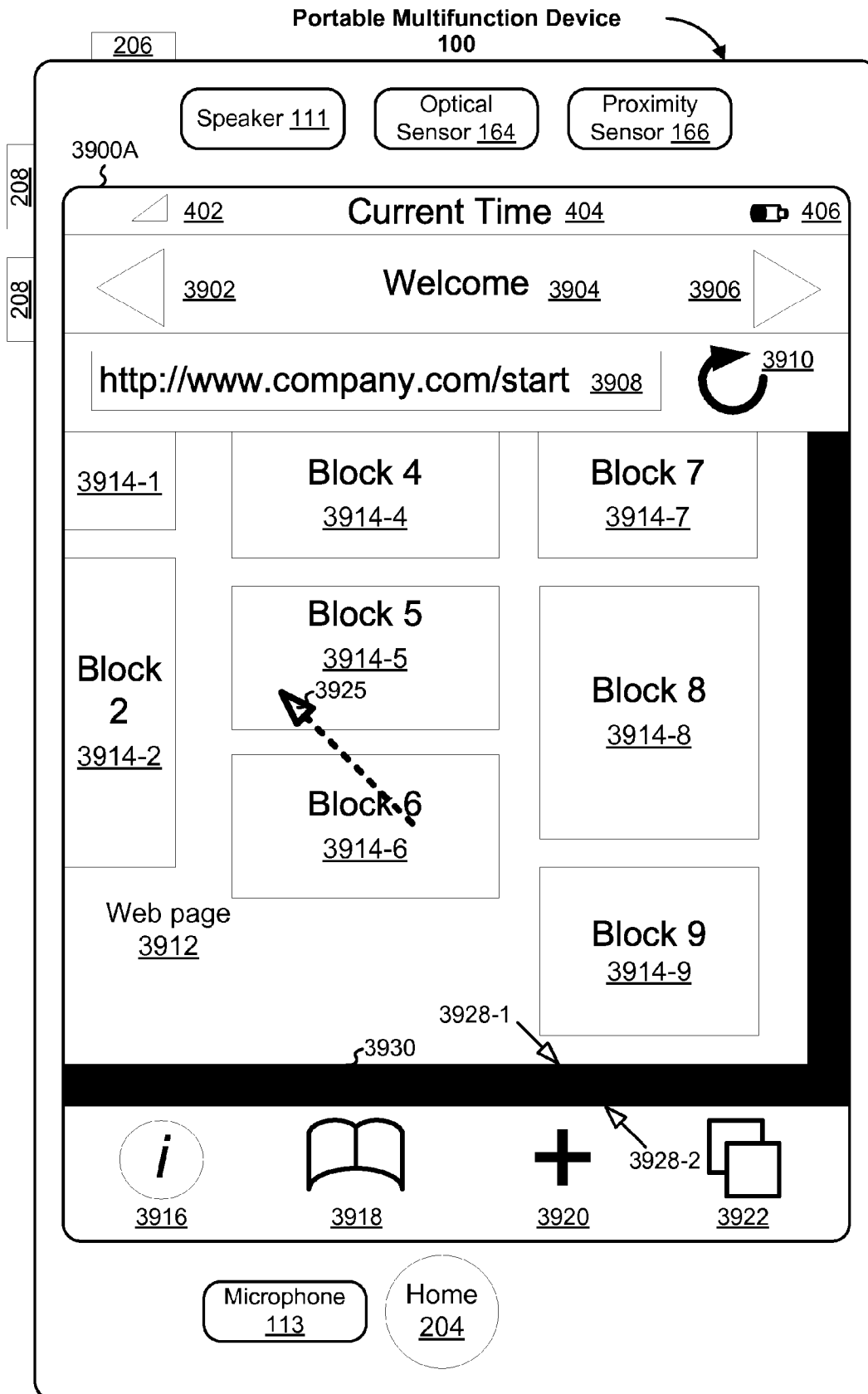

Figure 8C

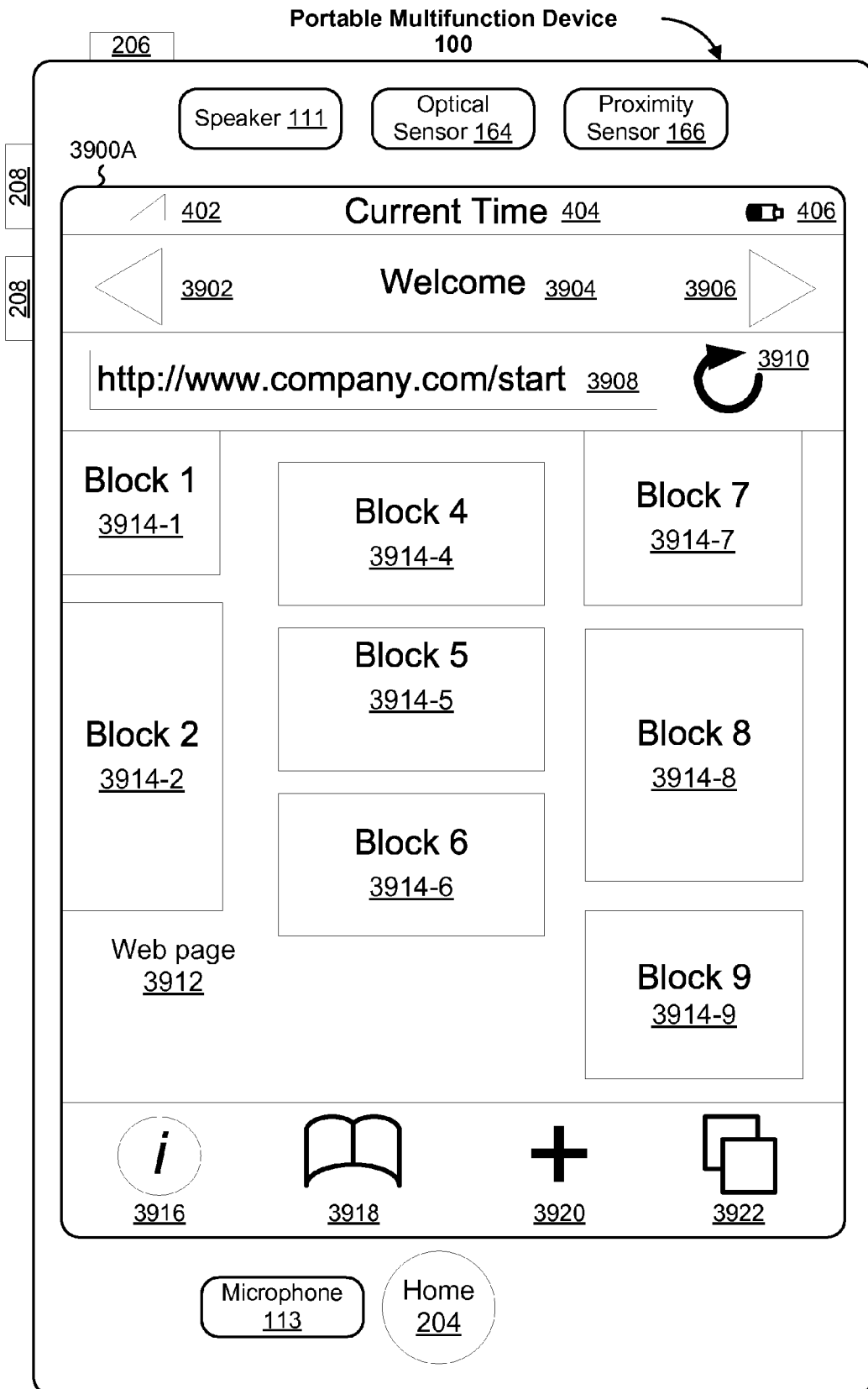

Figure 8D

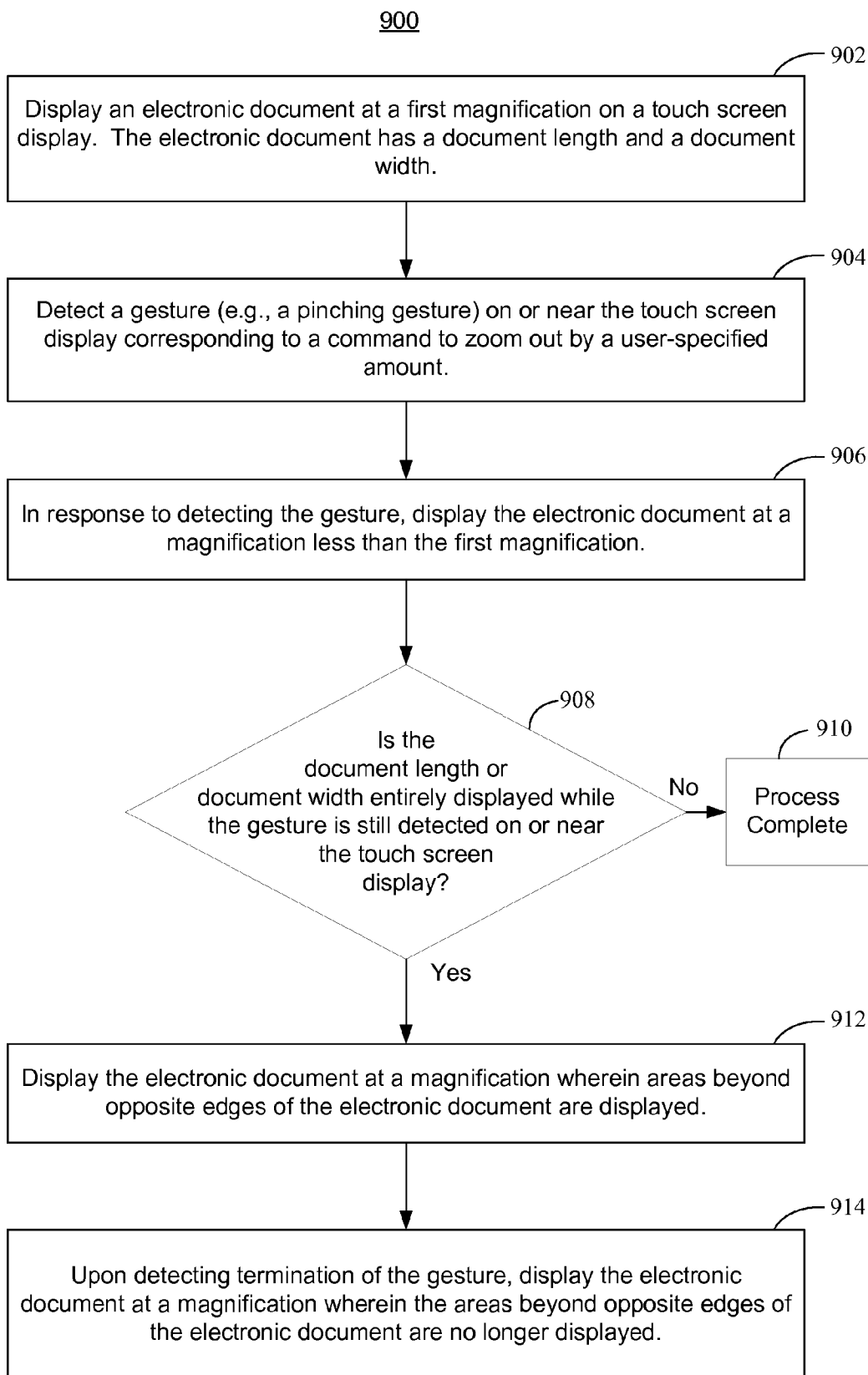

Figure 9

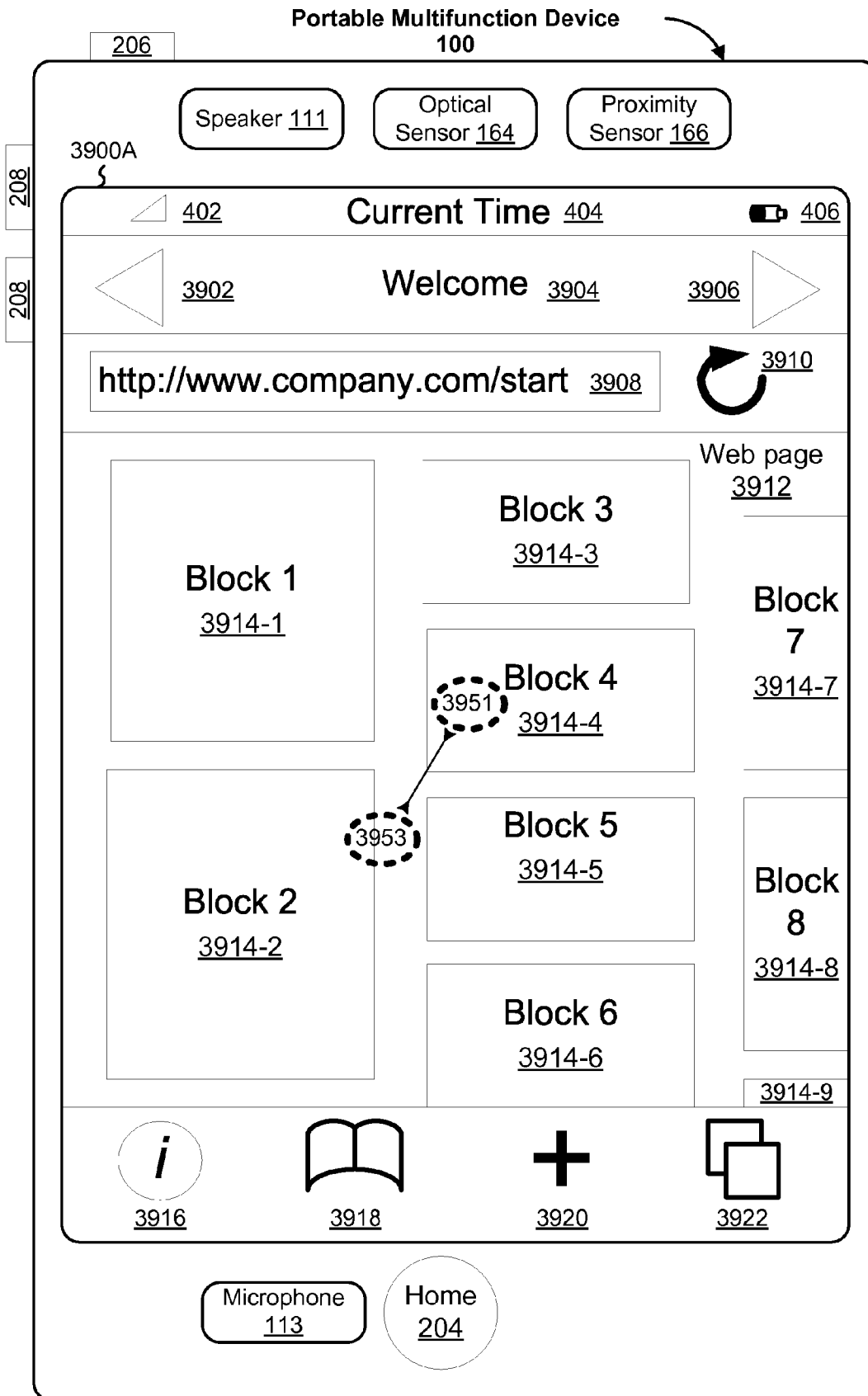

Figure 10A



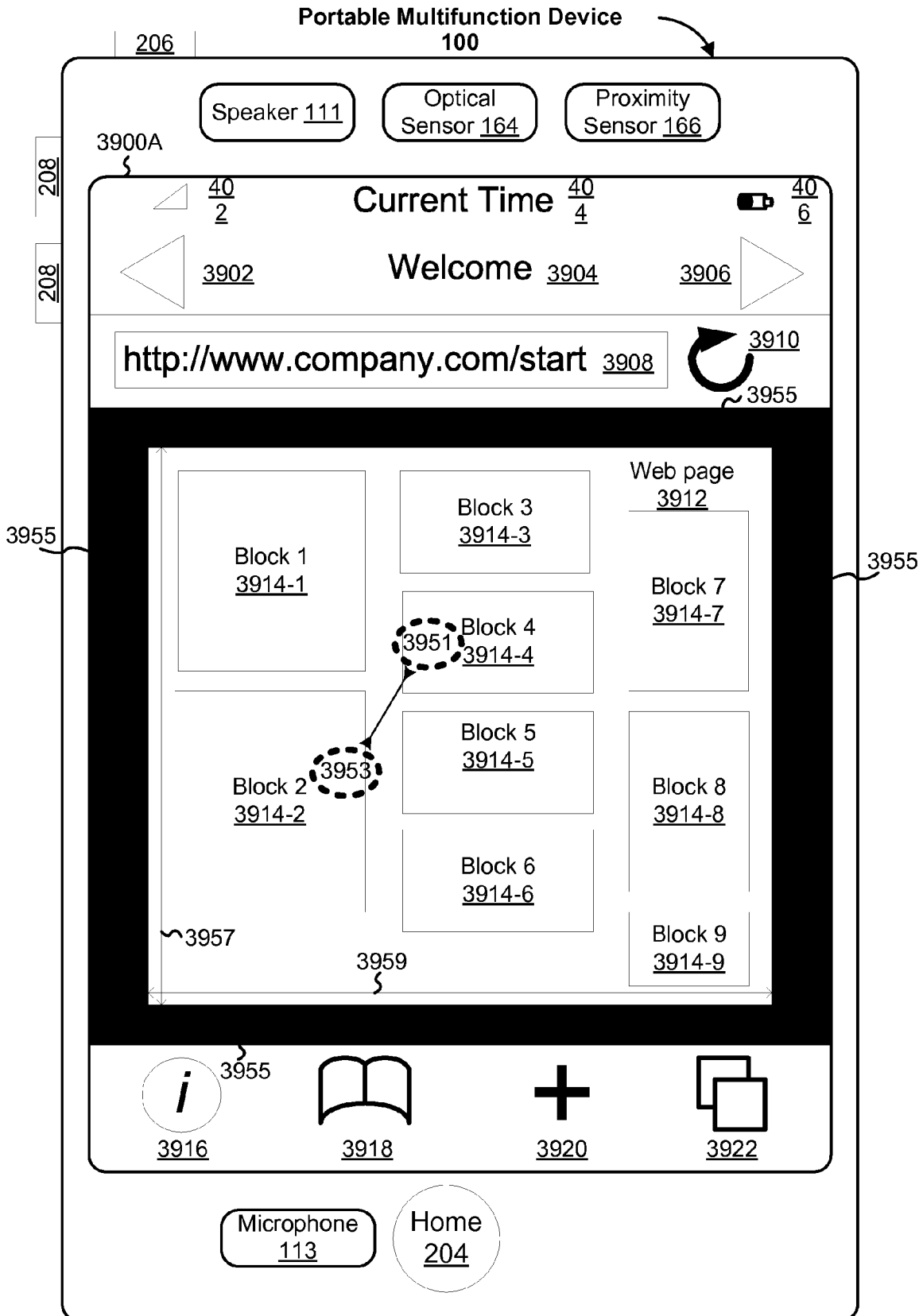

Figure 10B

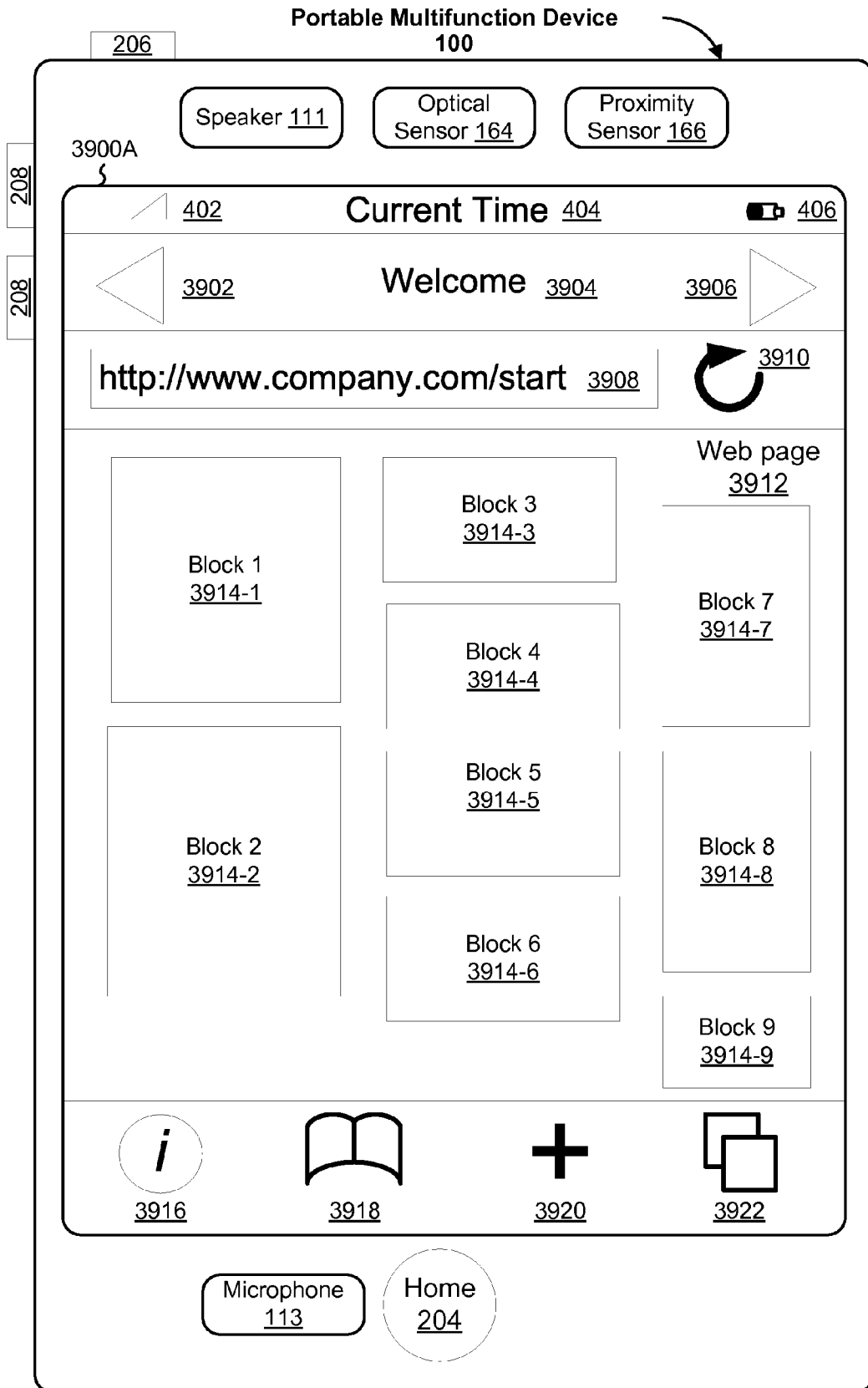

Figure 10C

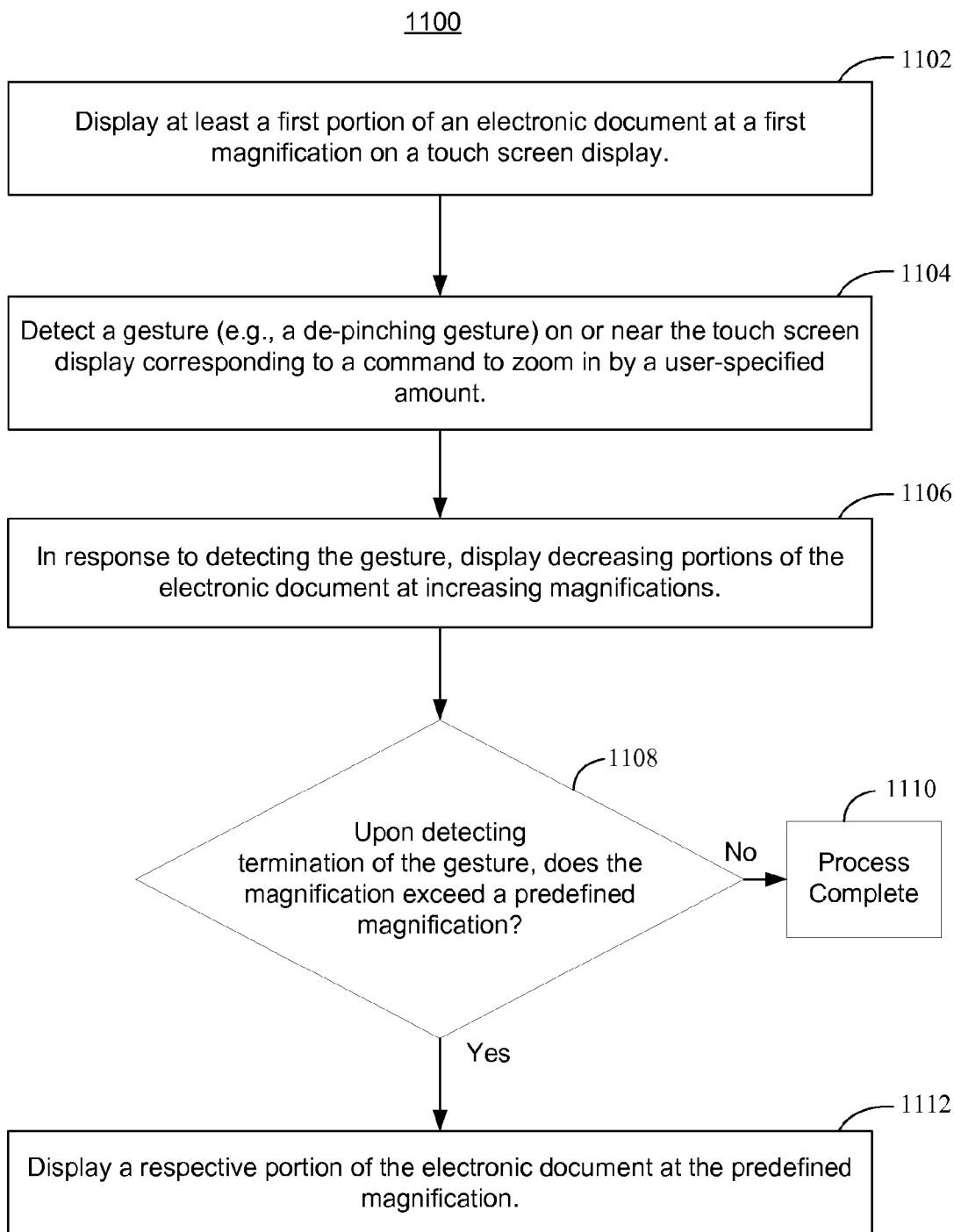

Figure 11

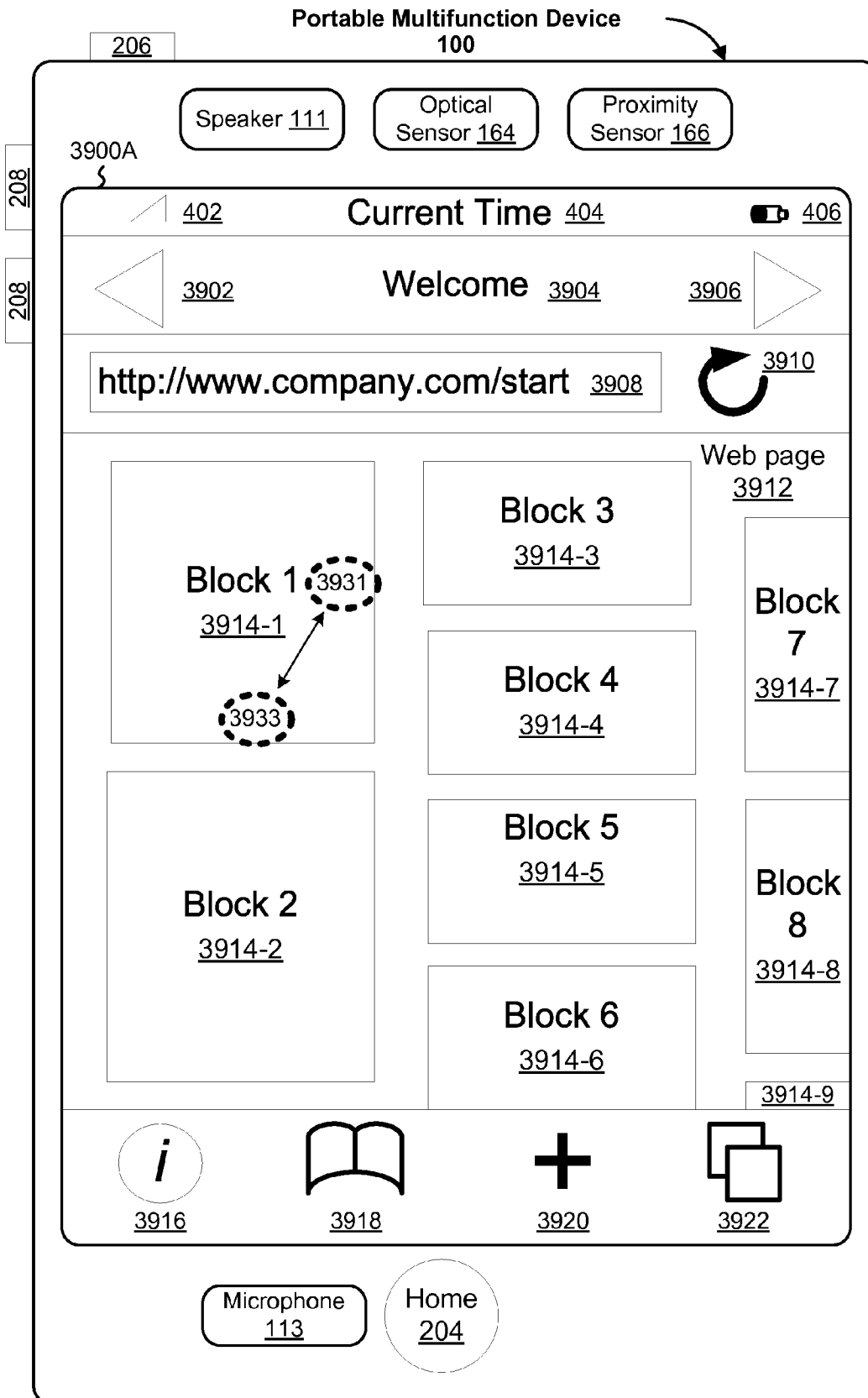

Figure 12A

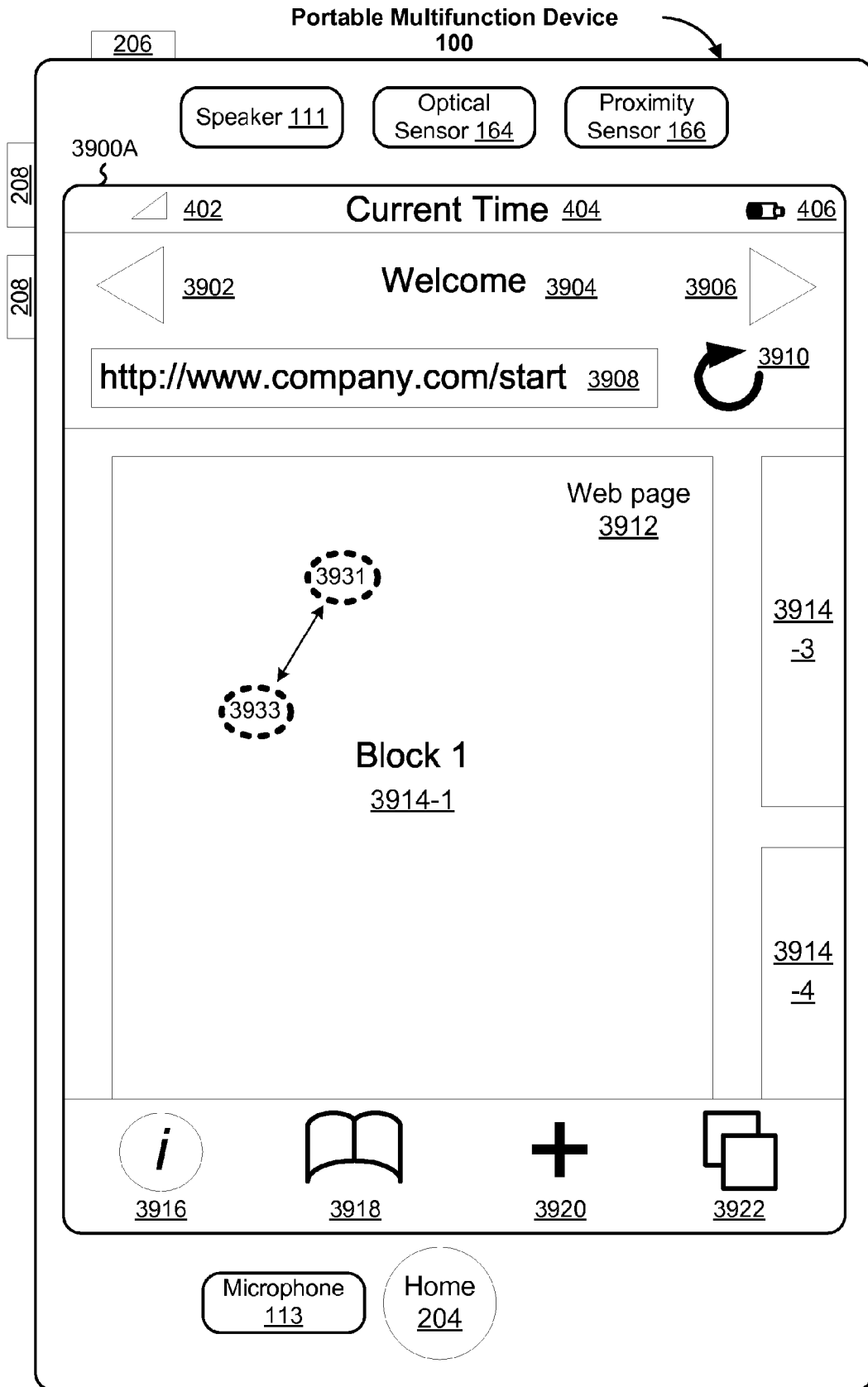

Figure 12B

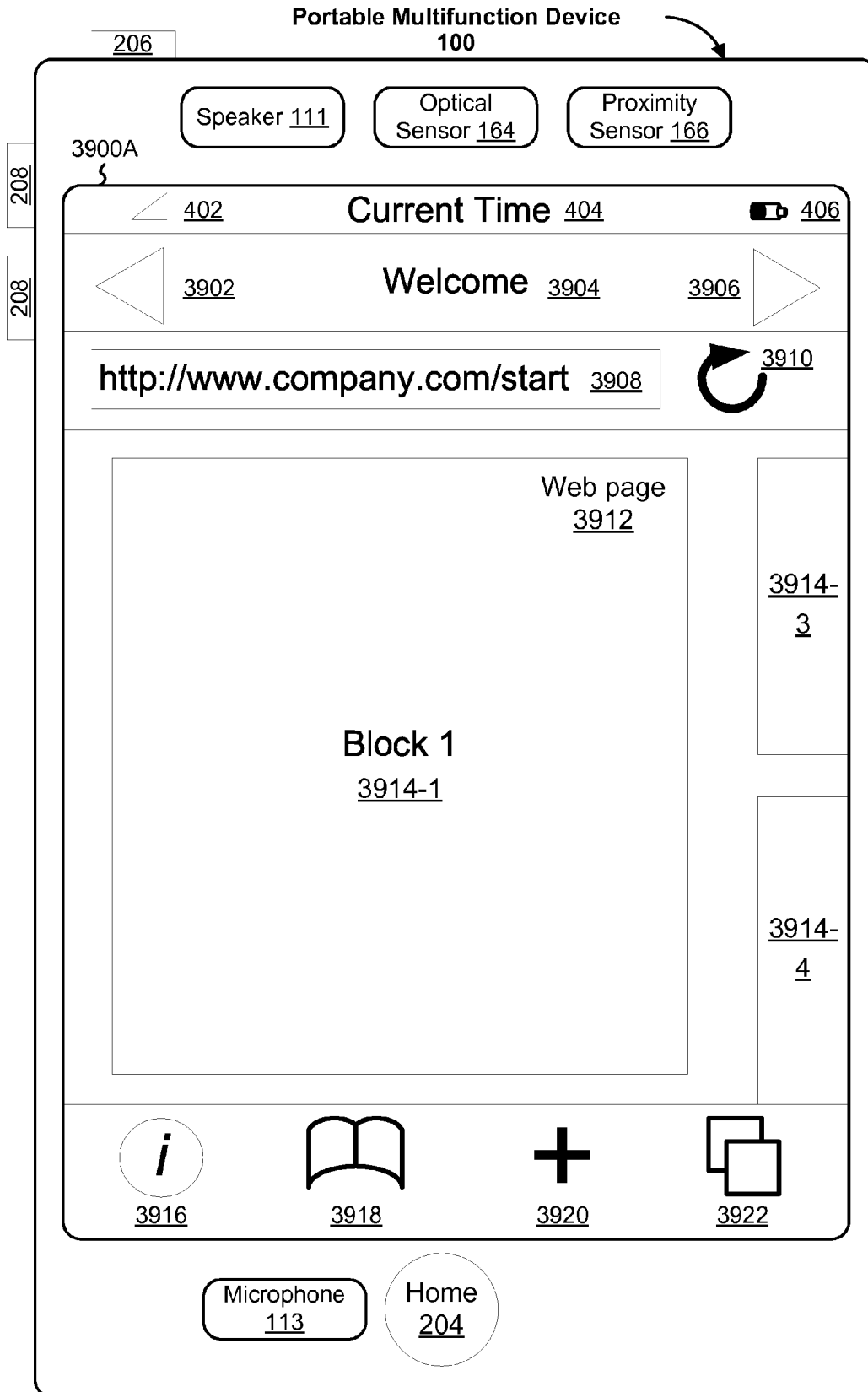

Figure 12C

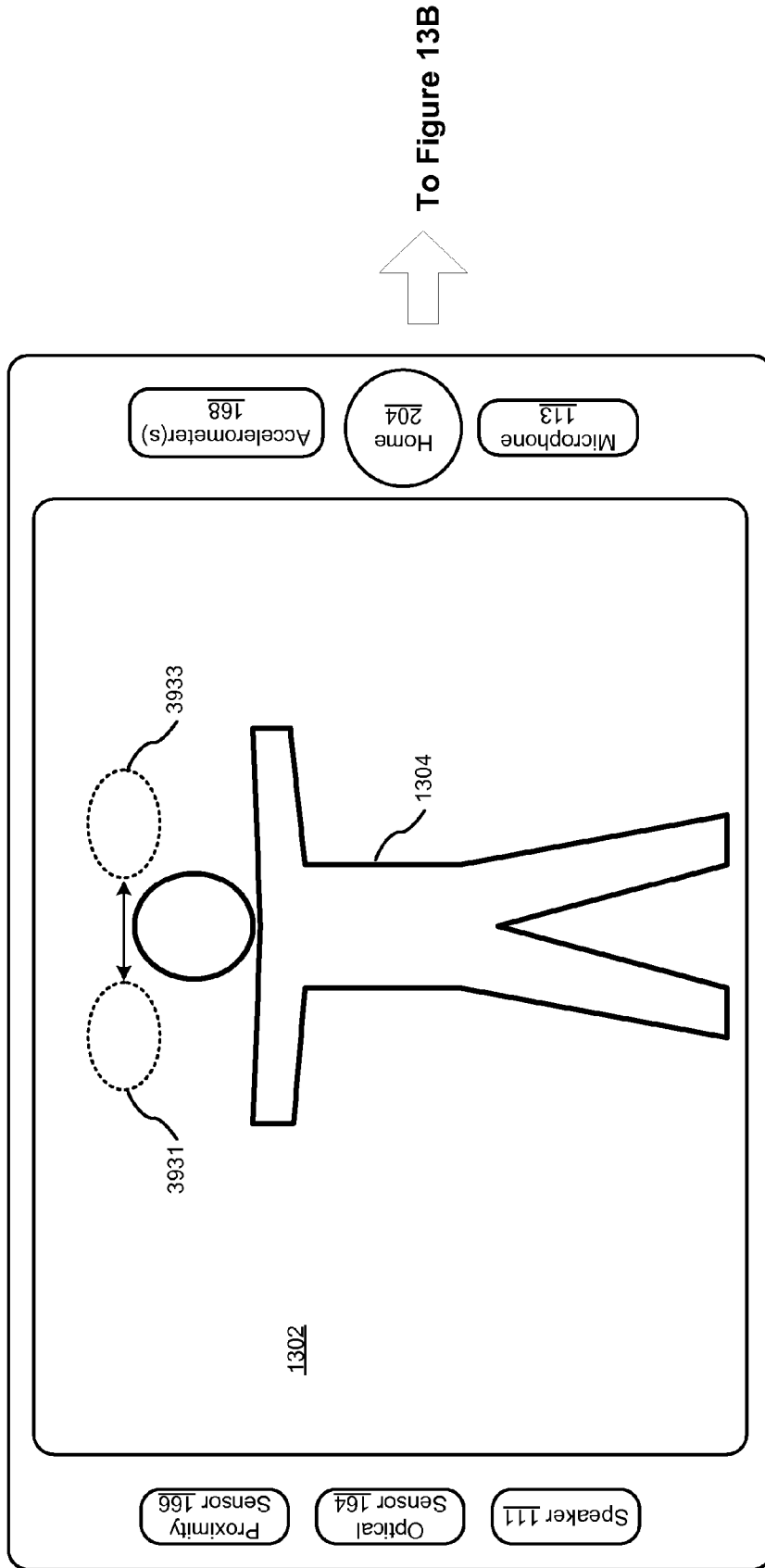
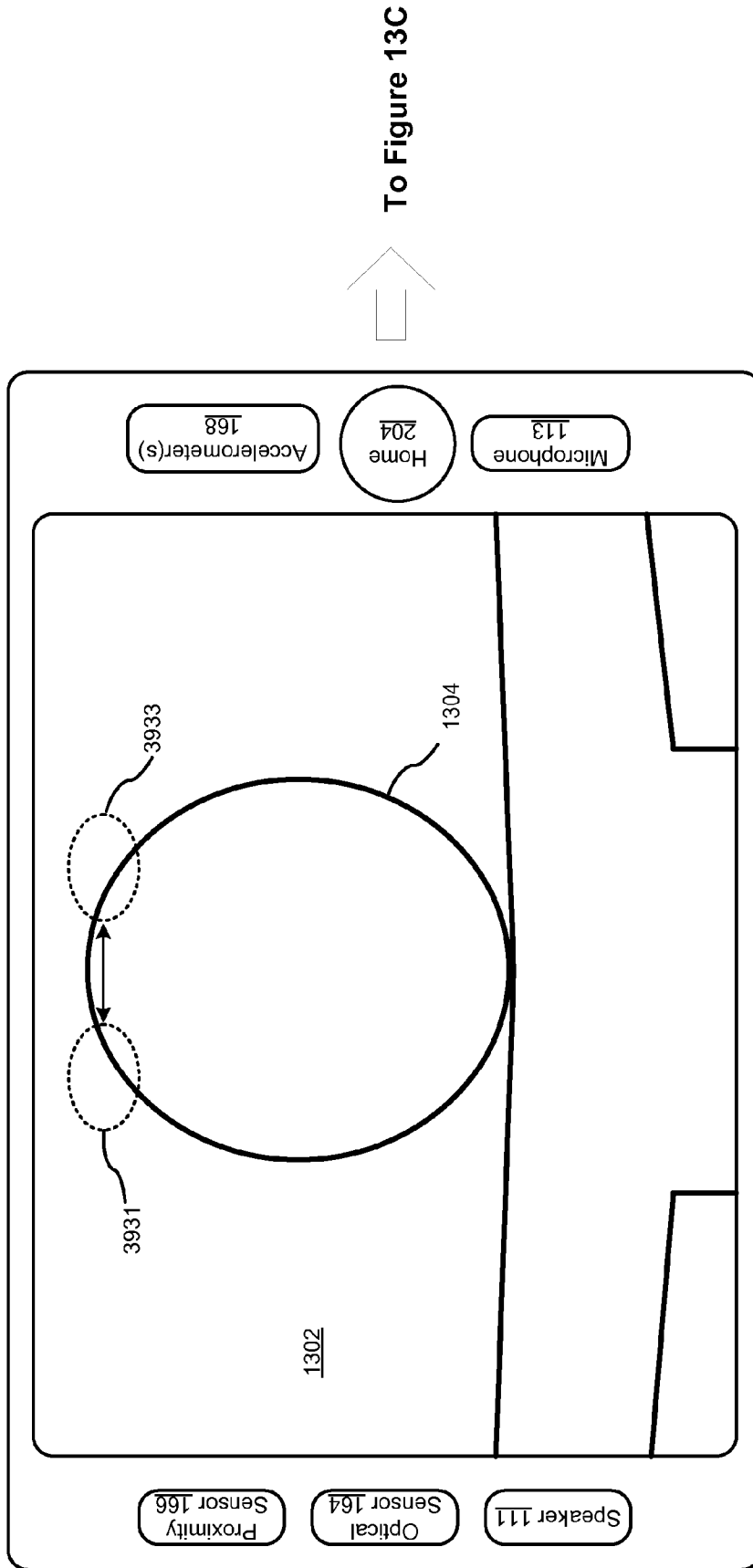

Figure 13A



To Figure 13C

Figure 13B



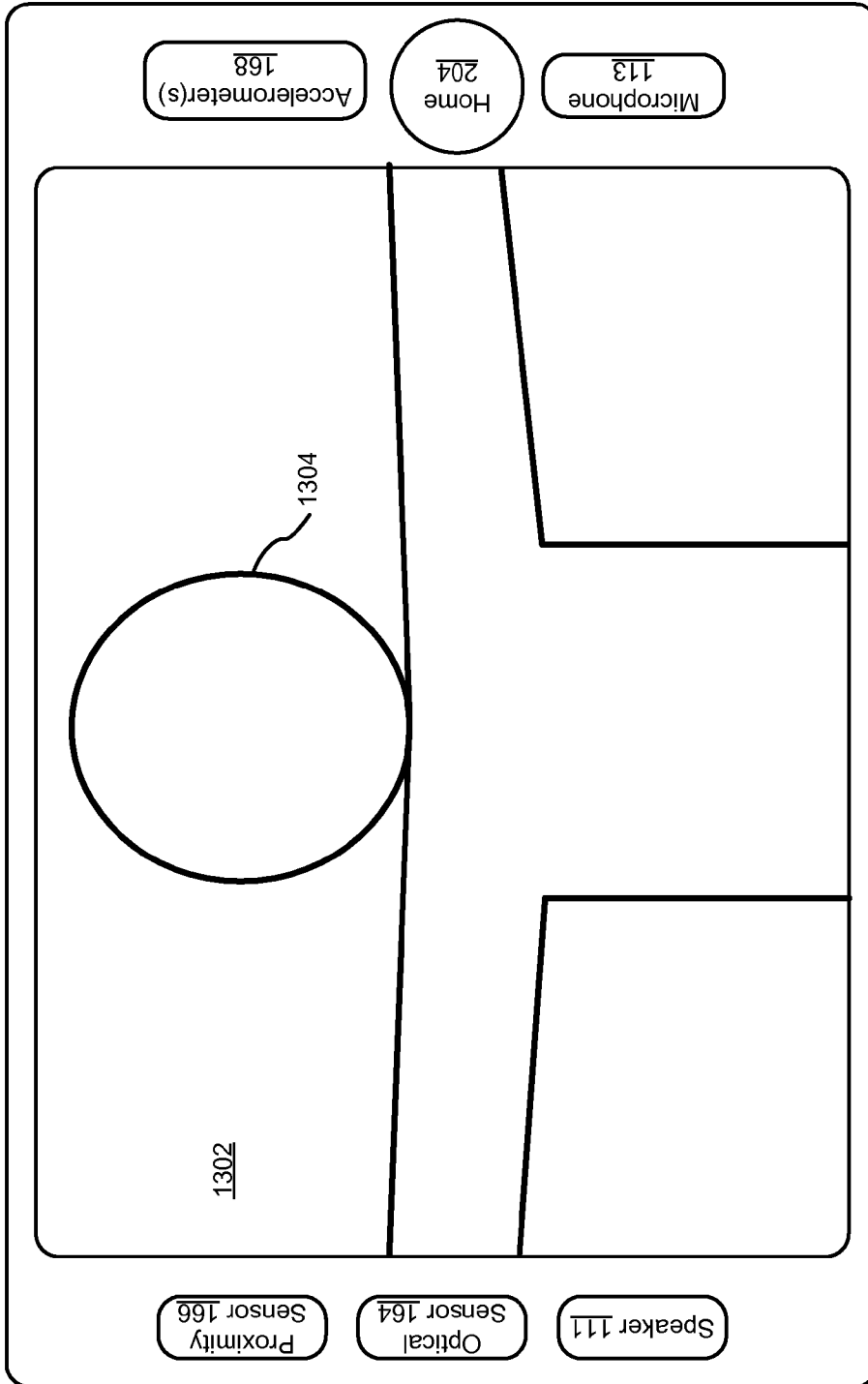

Figure 13C

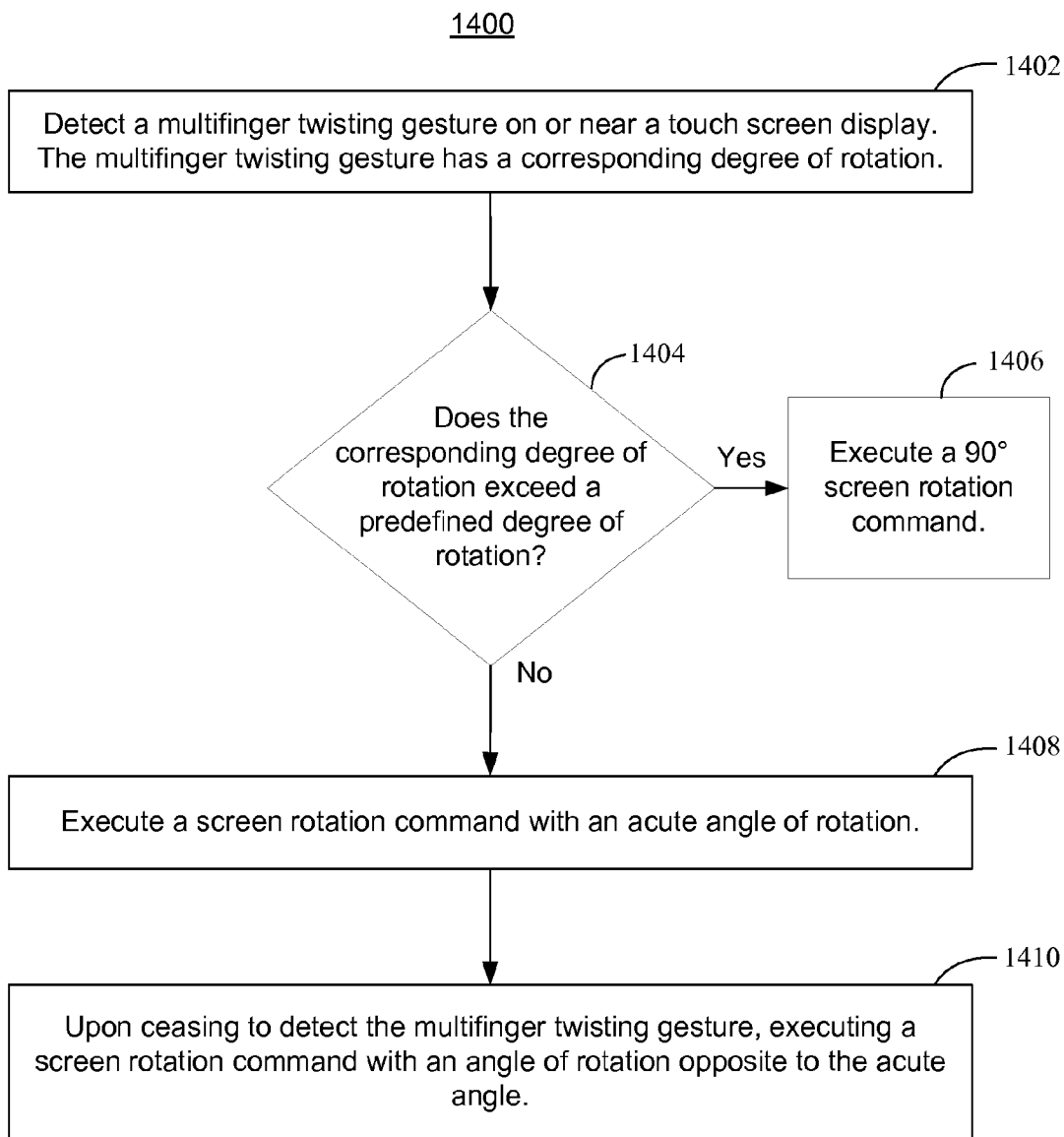
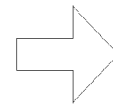
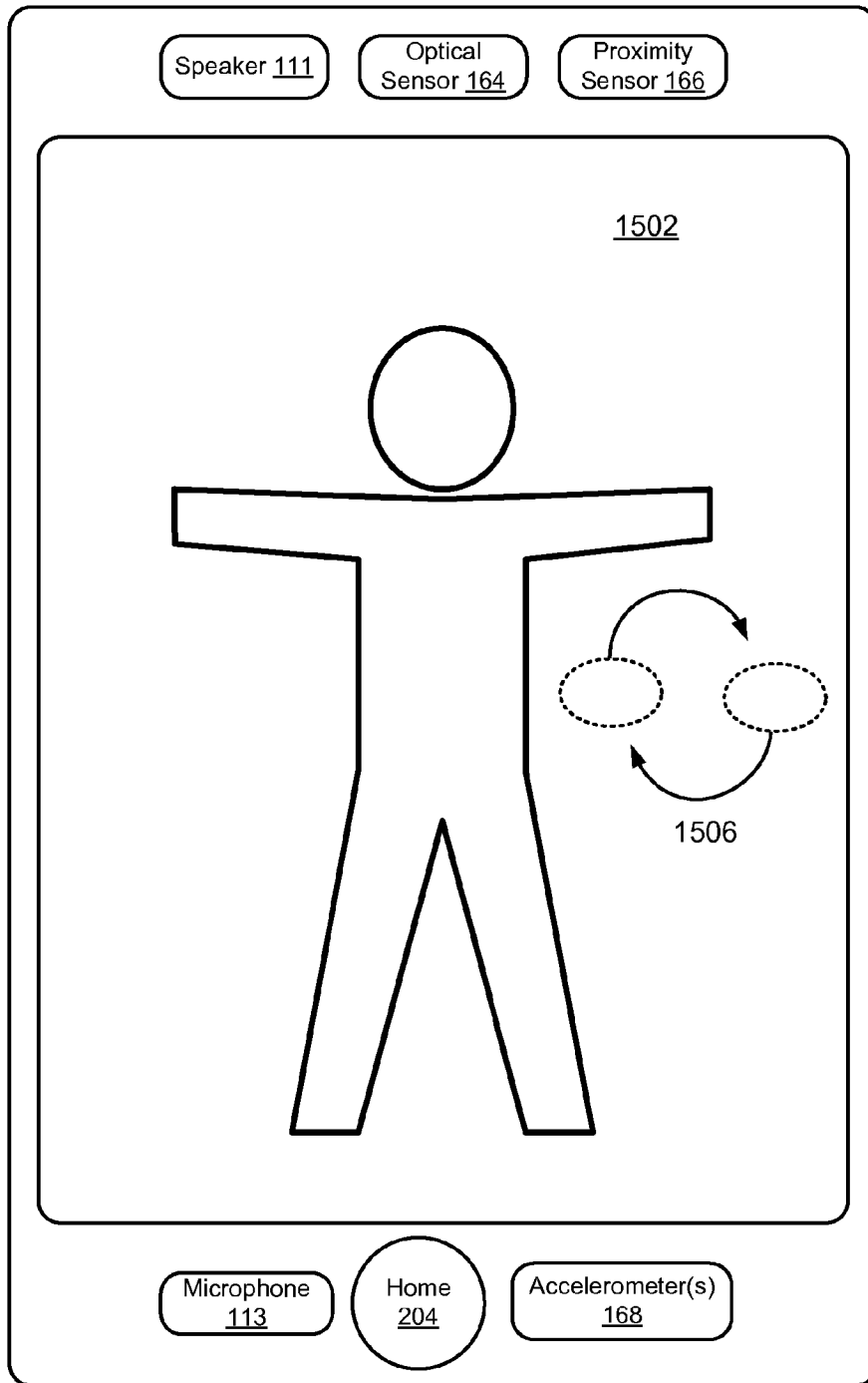

Figure 14



To Figure 15B

Figure 15A

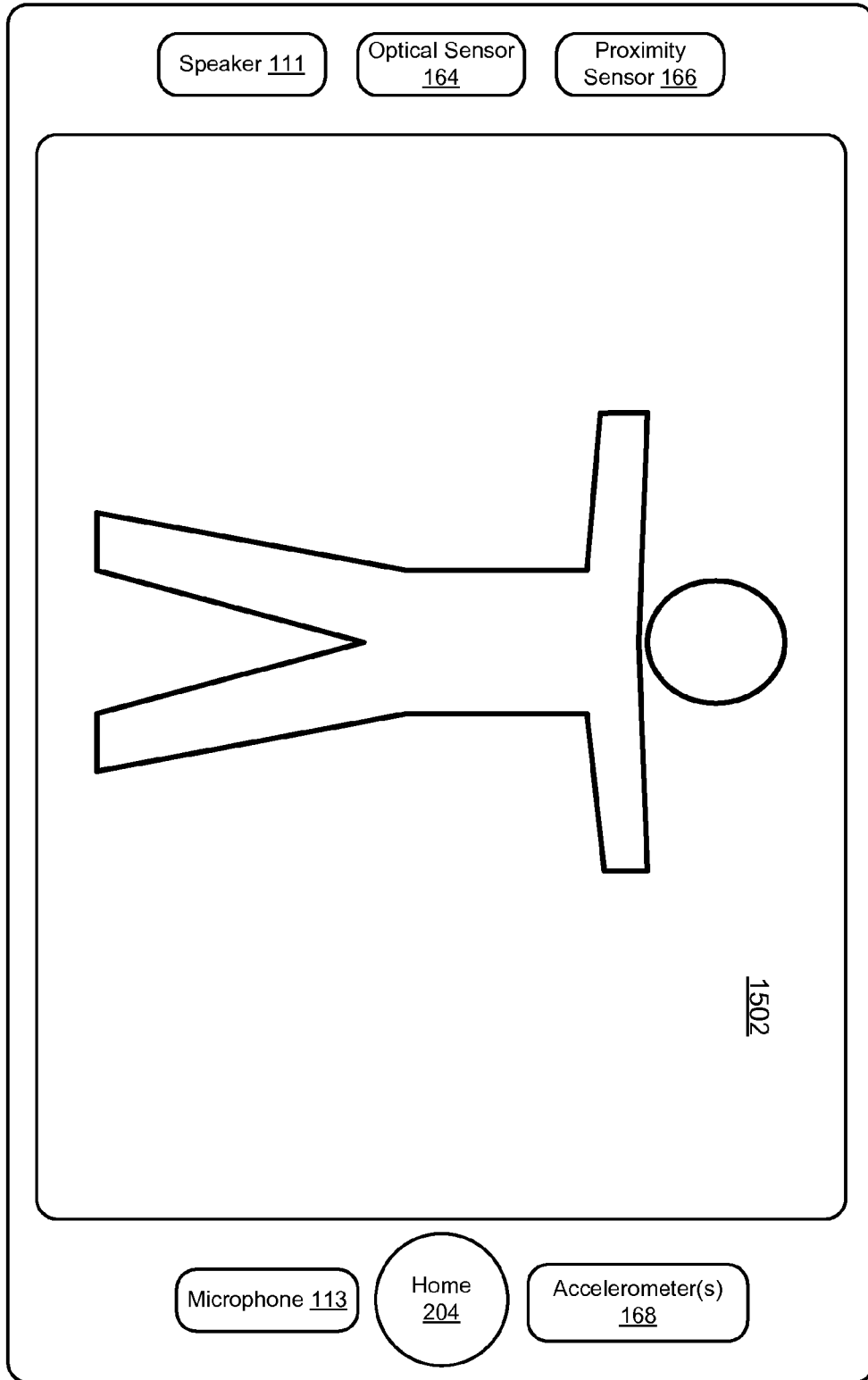
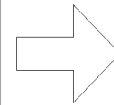
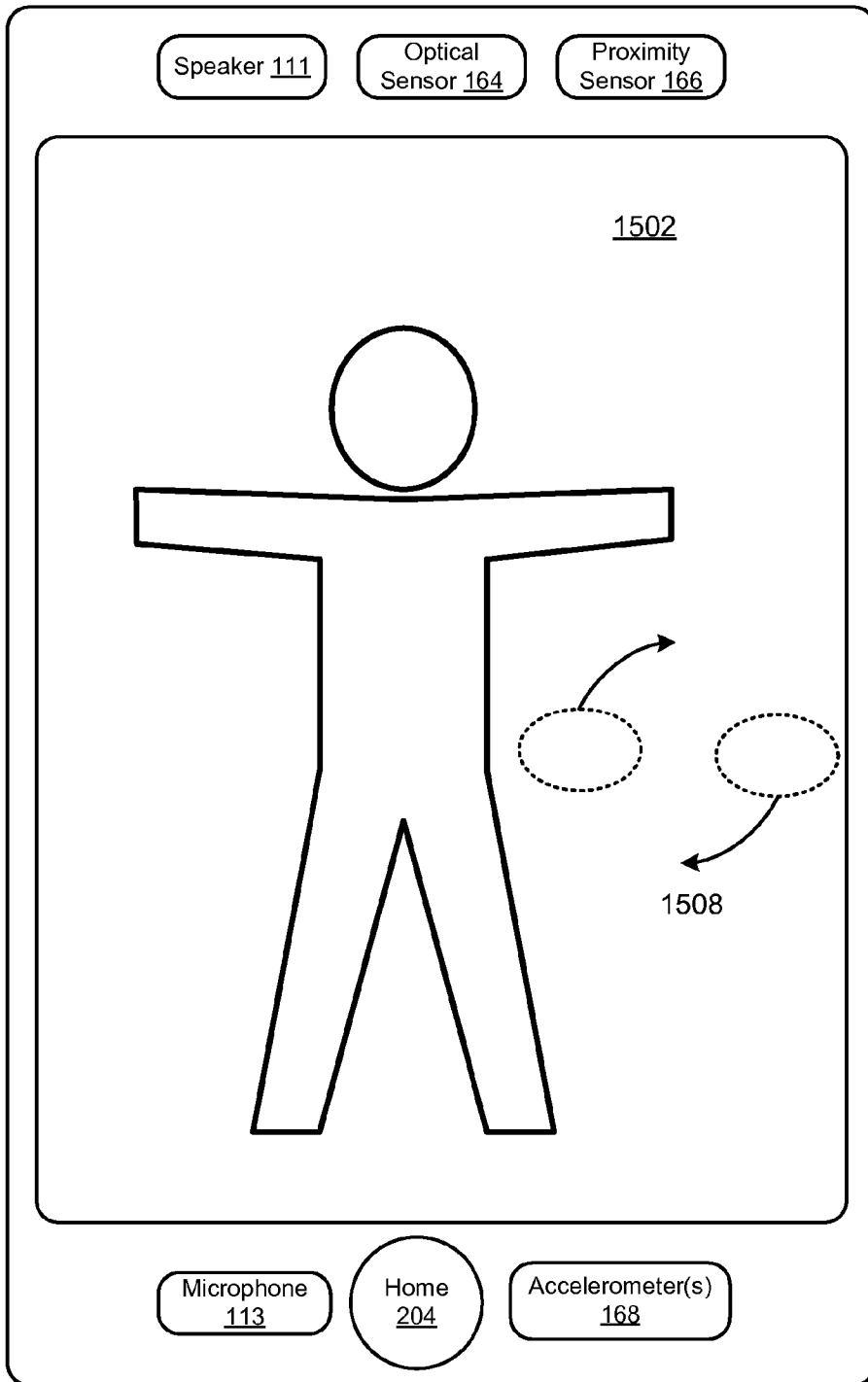
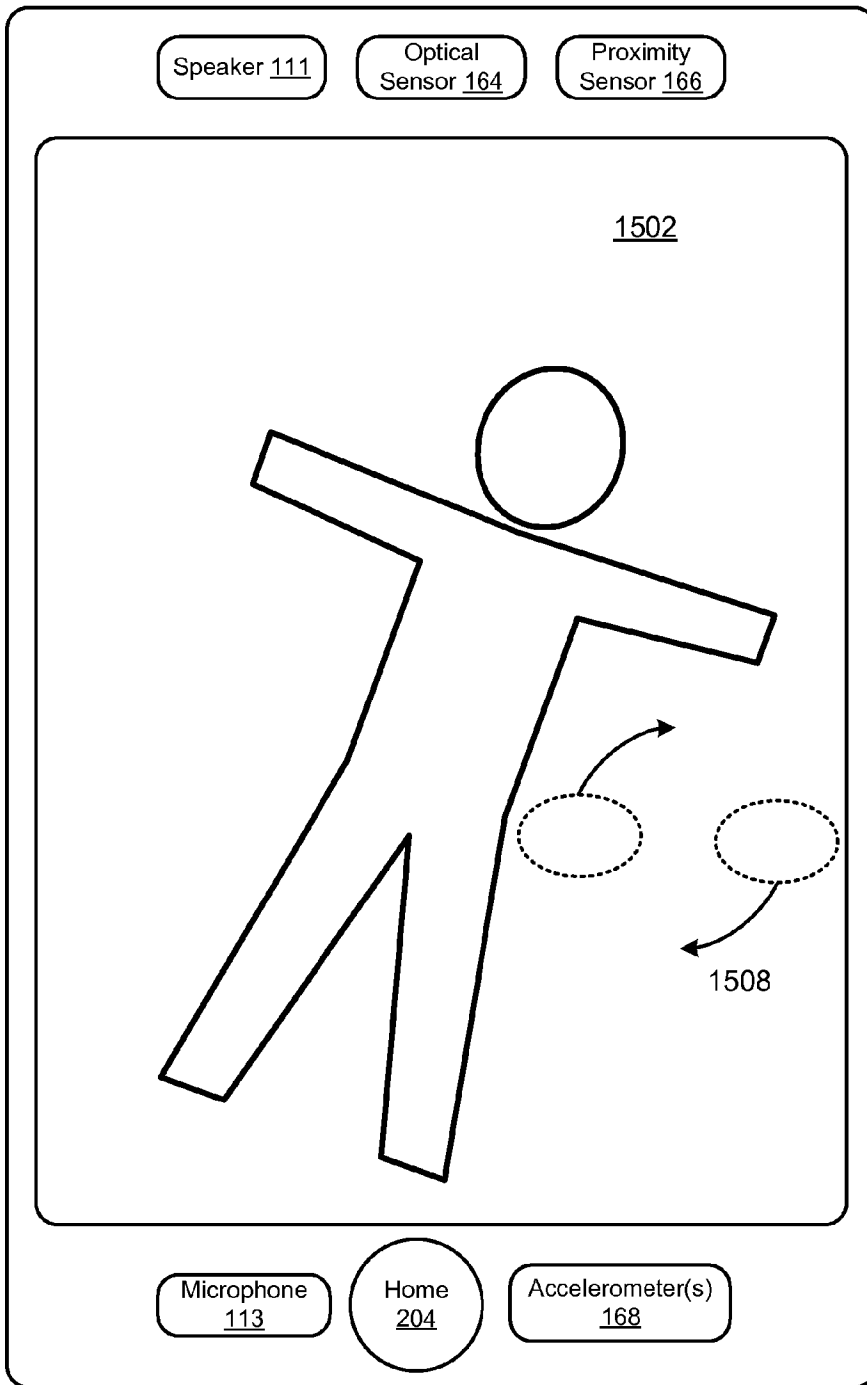

Figure 15B



To Figure 15D

Figure 15C



➤  
To Figure 15E

Figure 15D

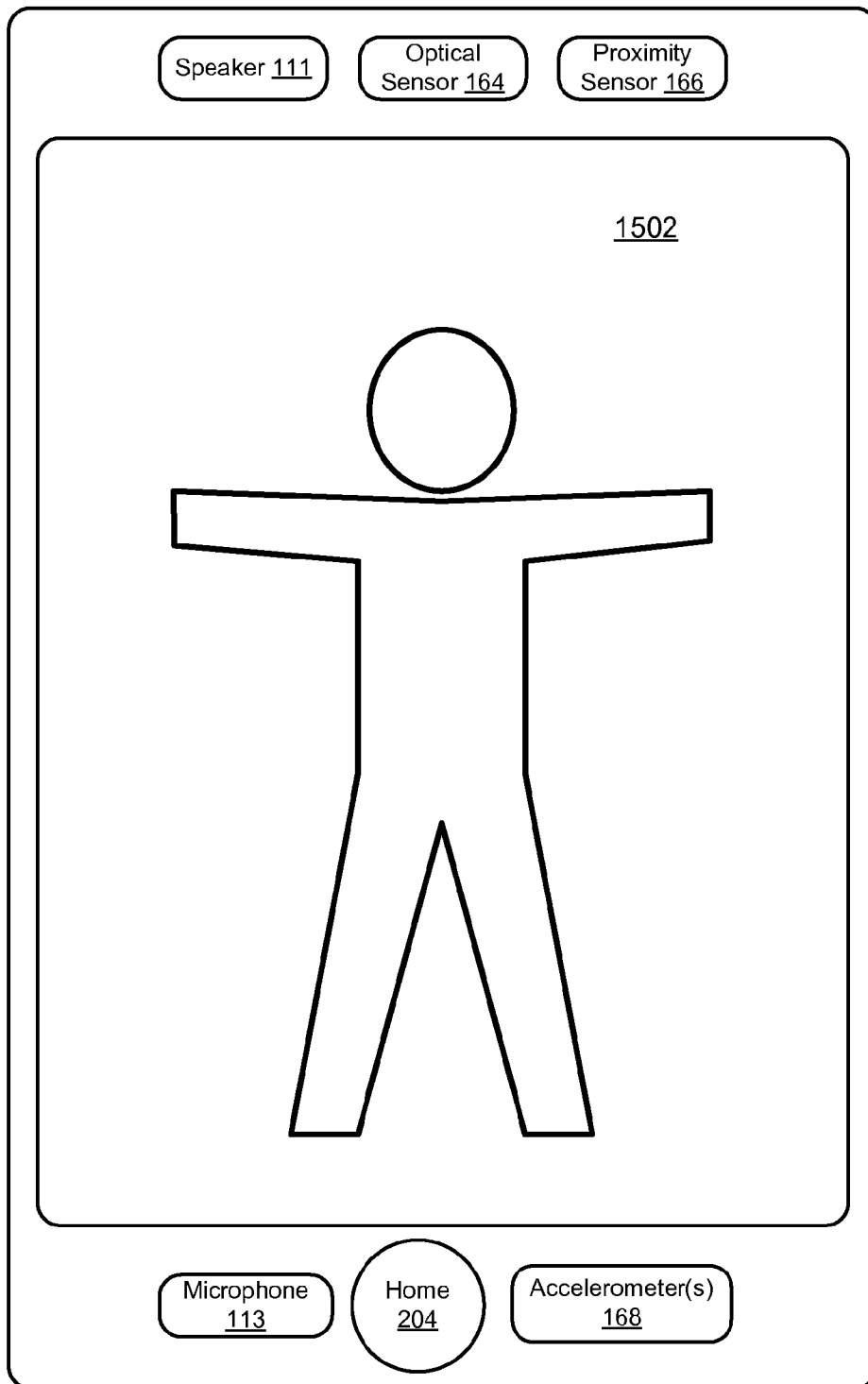

Figure 15E

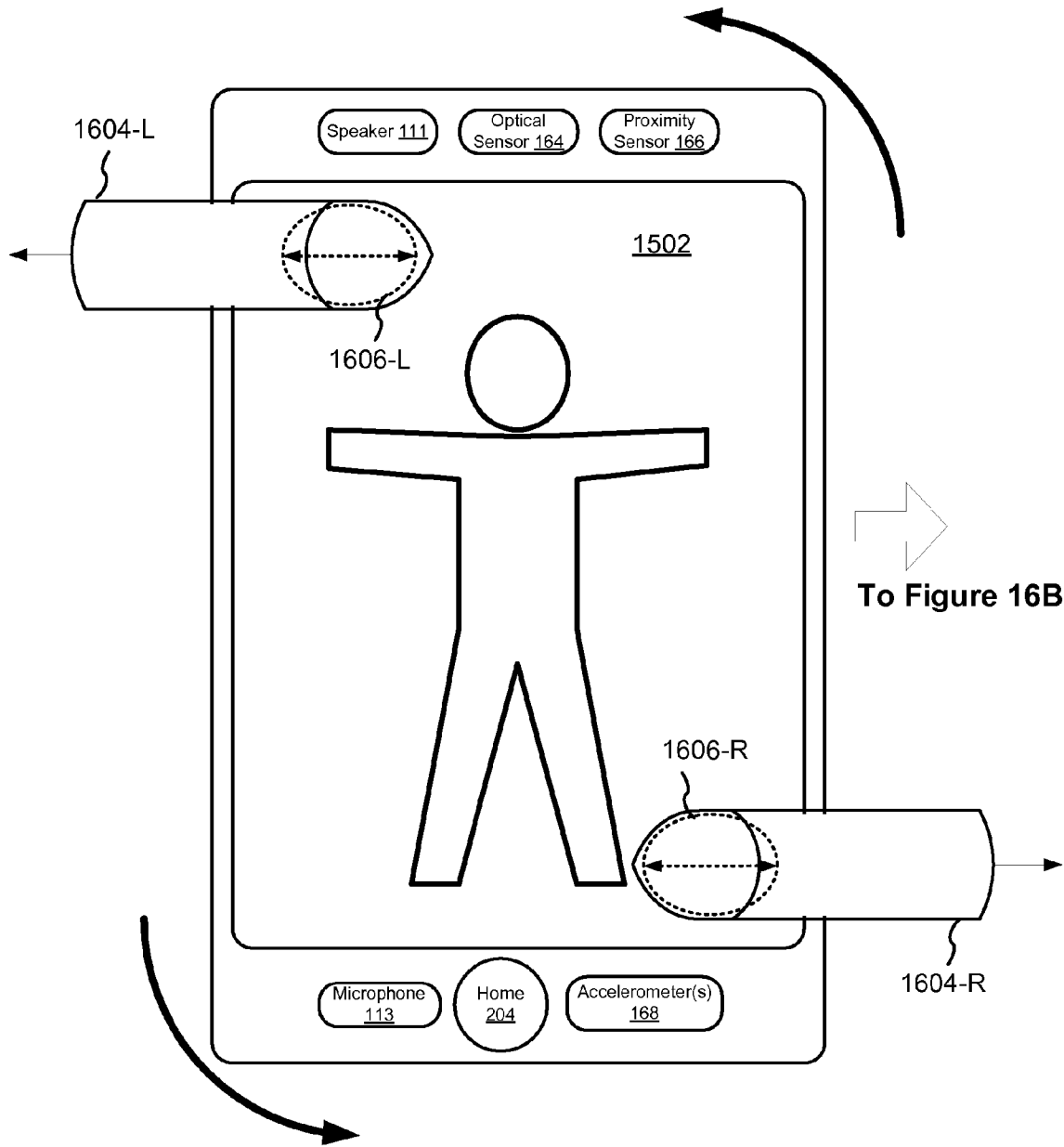

Figure 16A



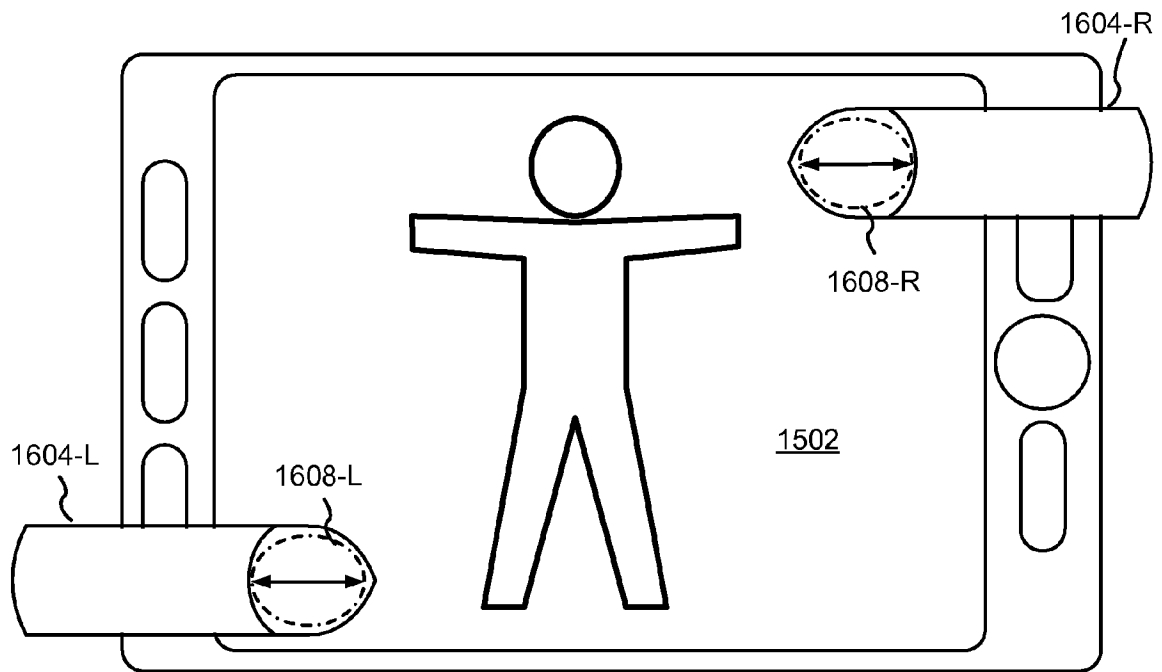

Figure 16B

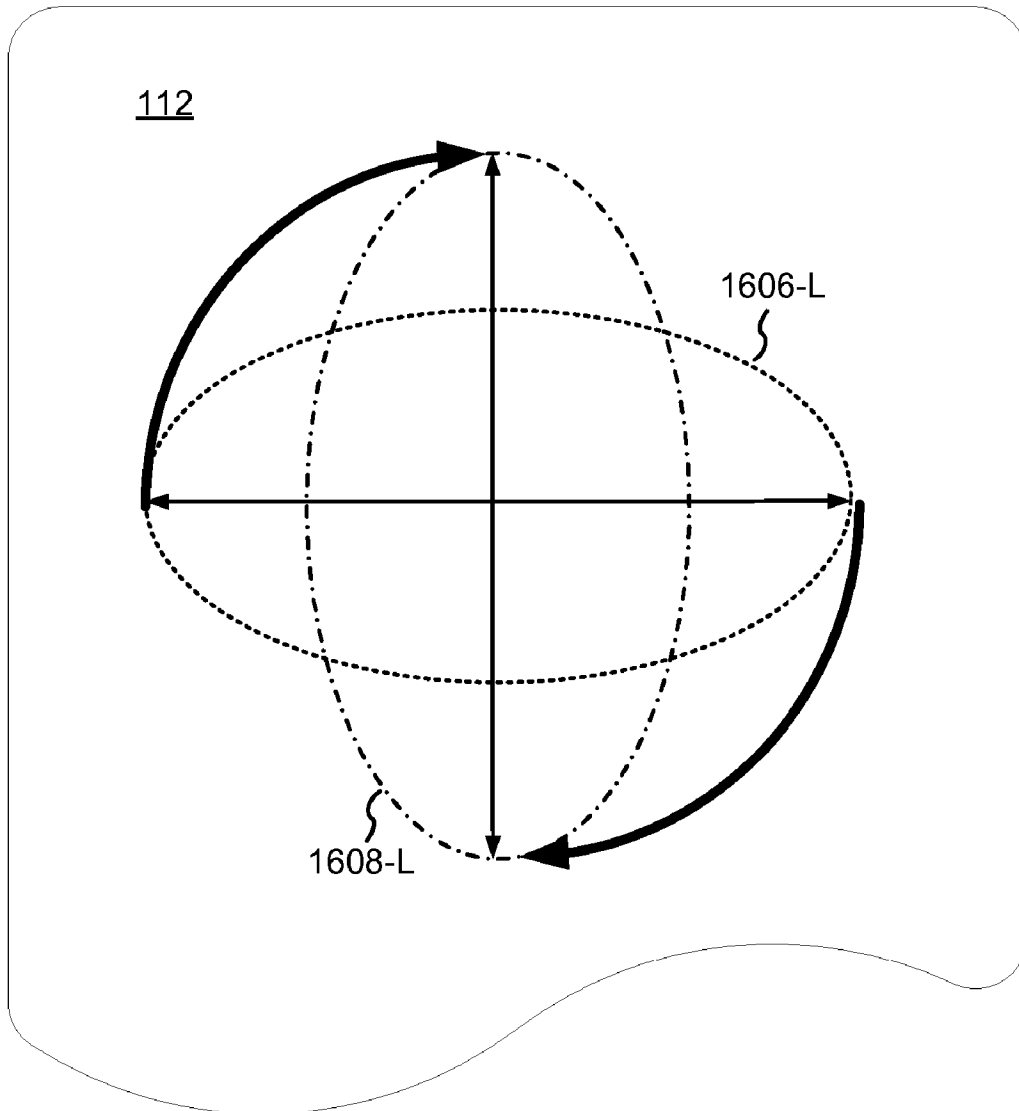

Figure 16C

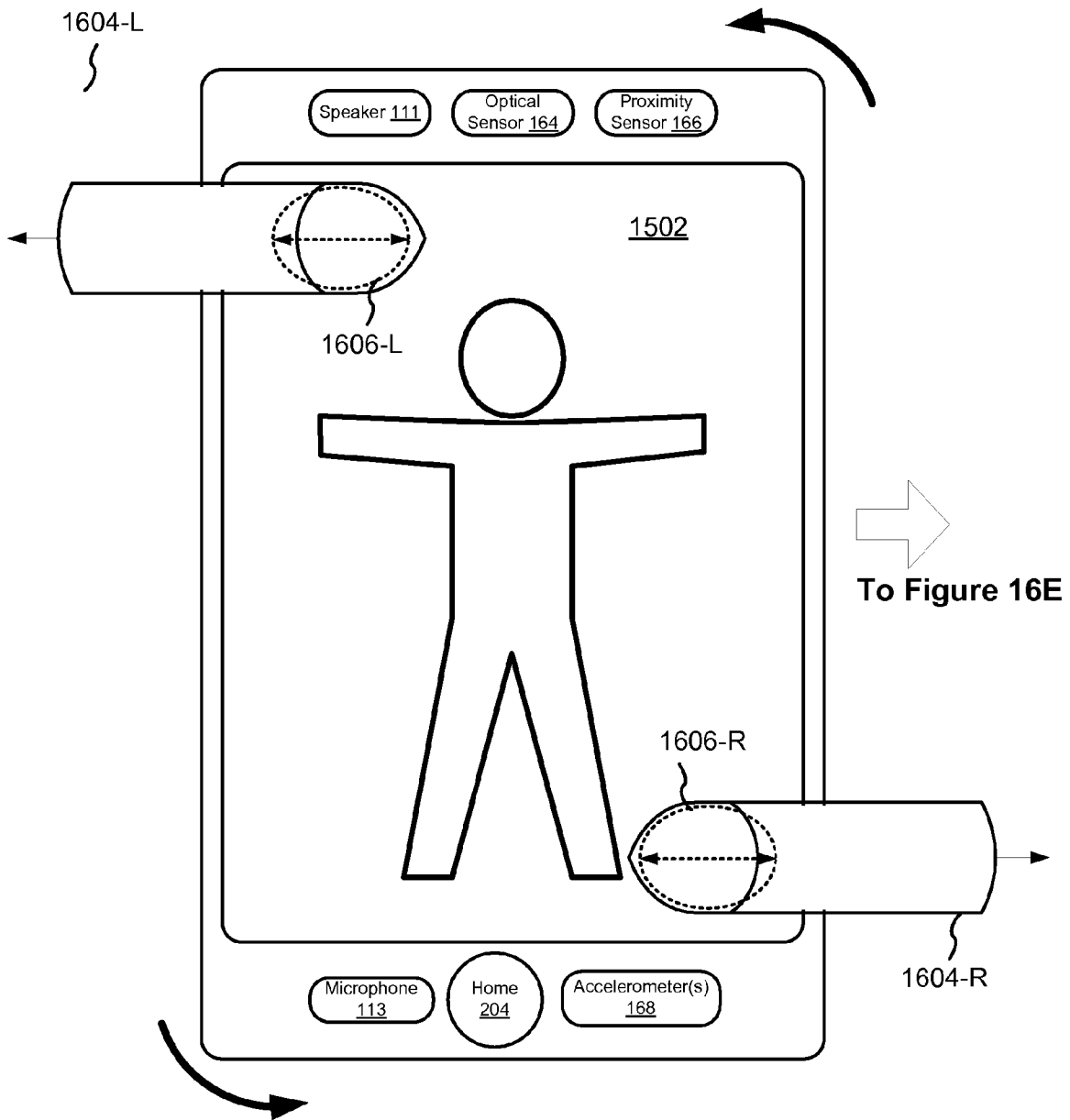

Figure 16D

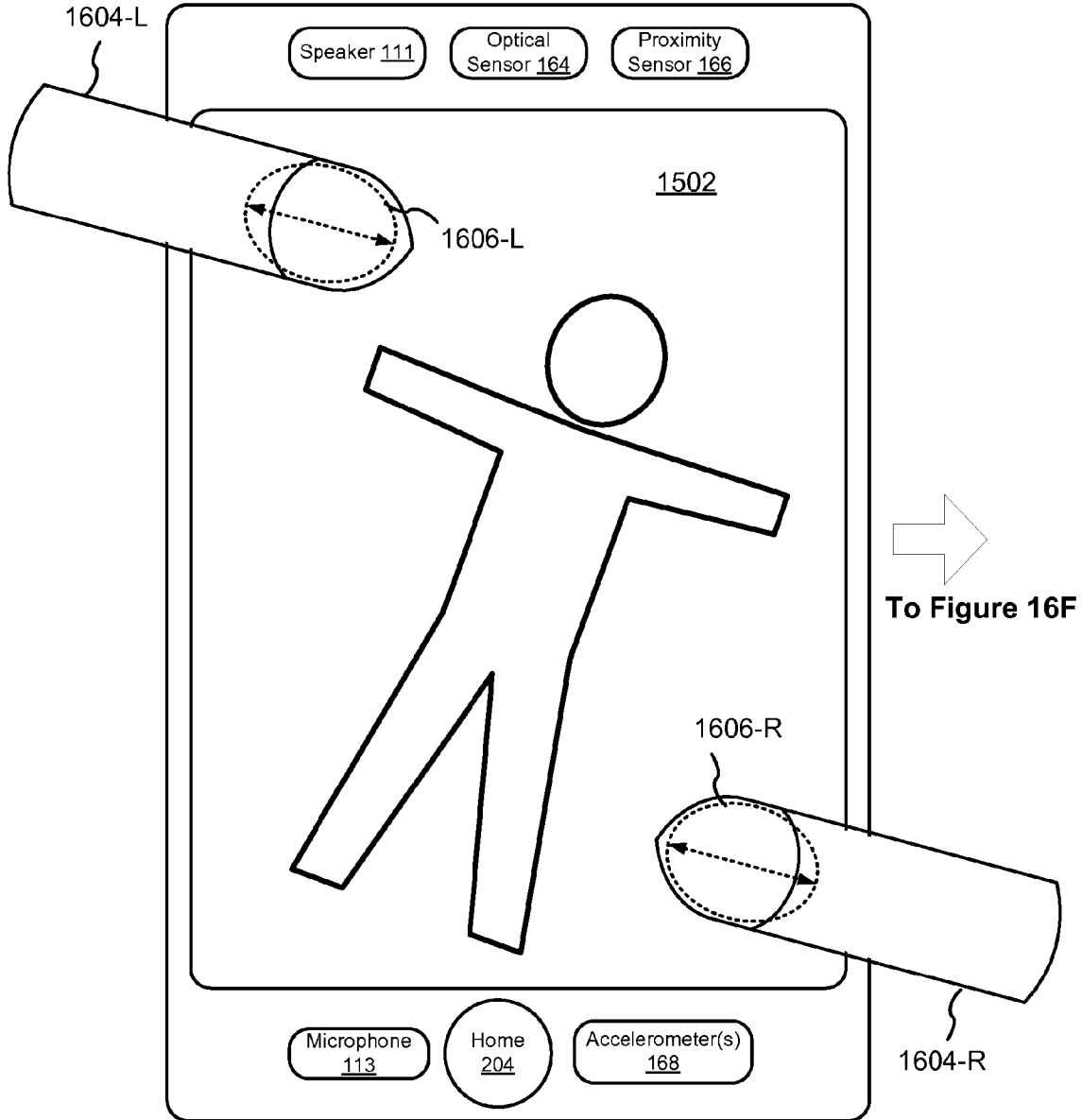

Figure 16E

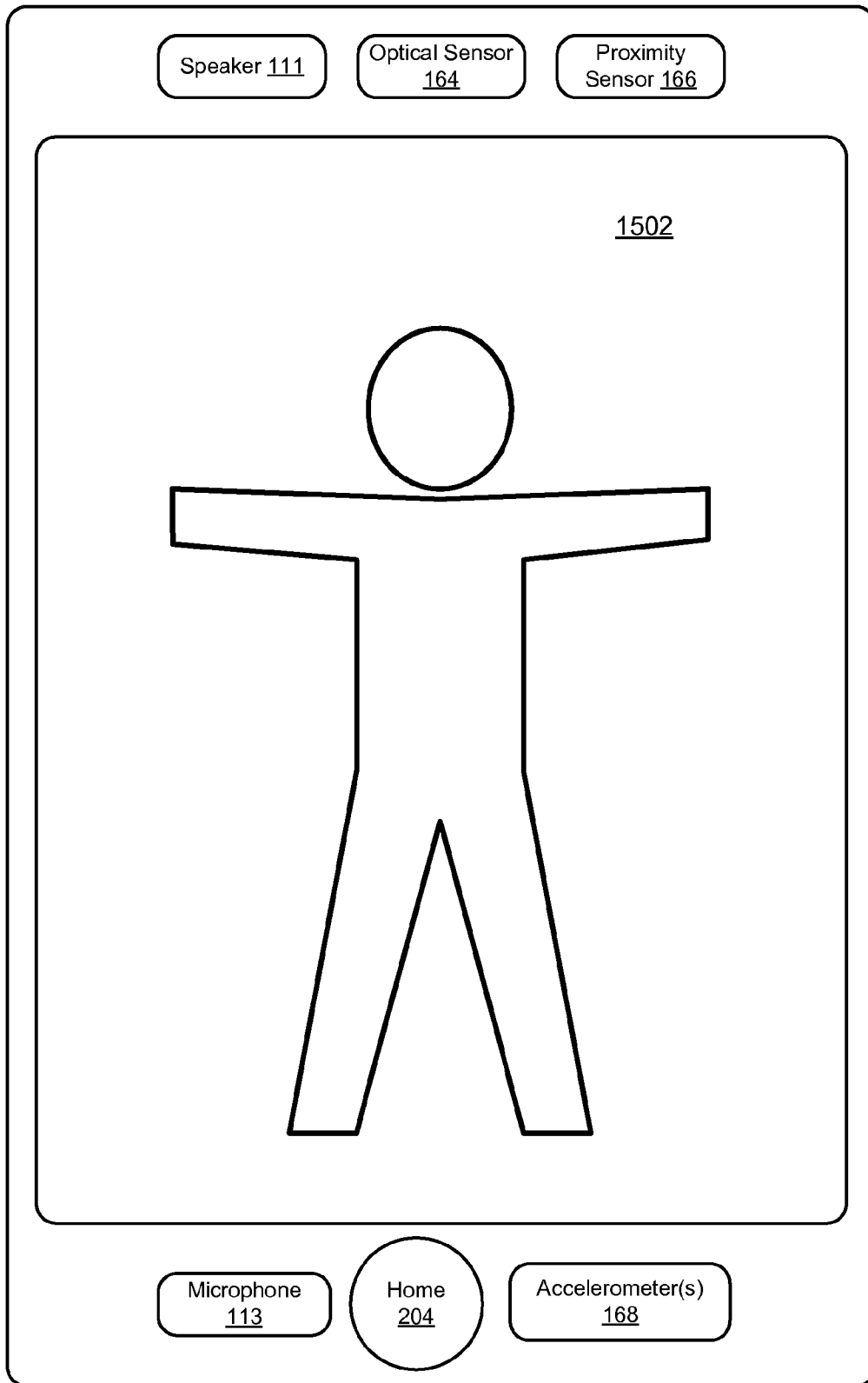

Figure 16F

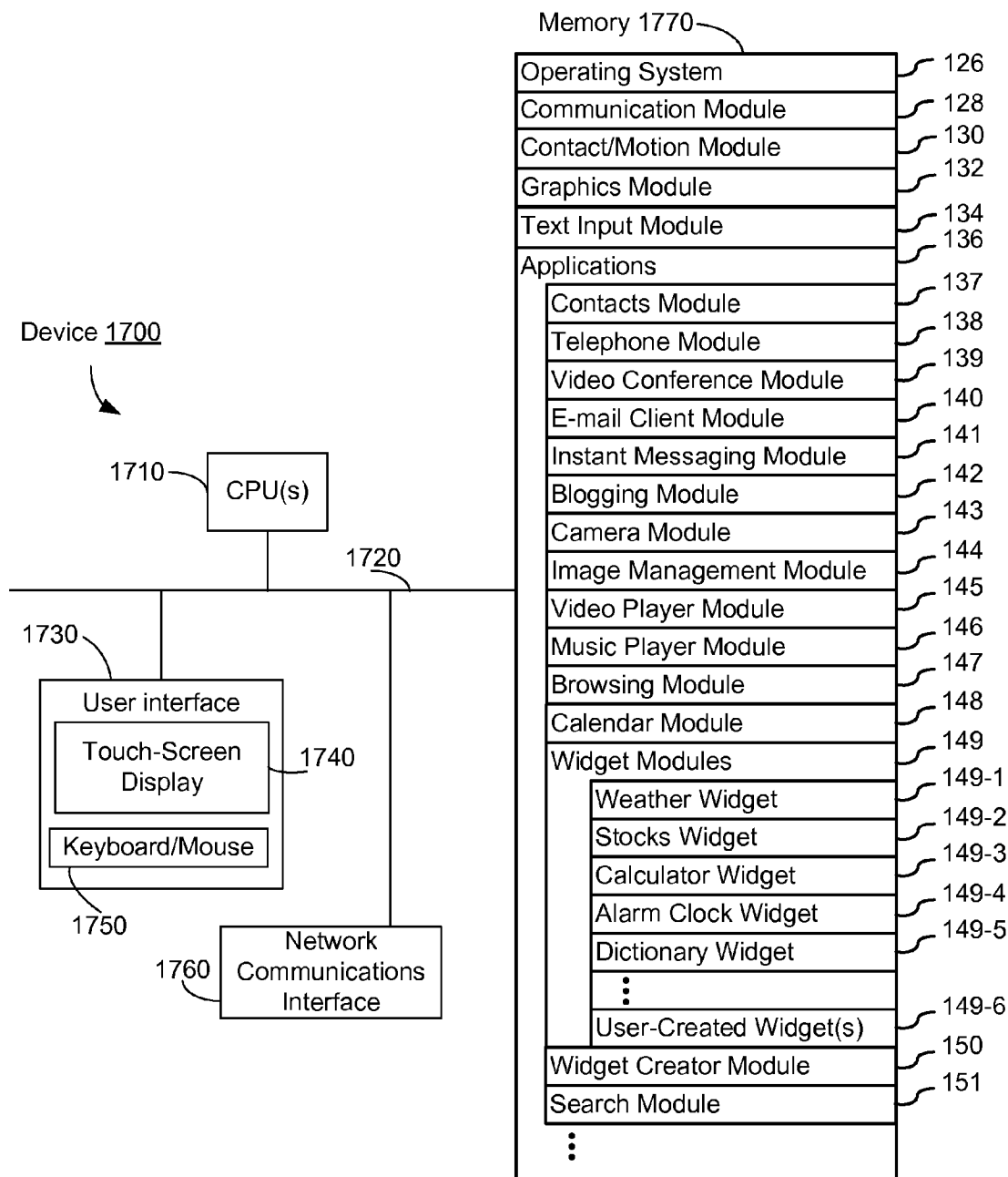

Figure 17

US 7,469,381 B2

1

**LIST SCROLLING AND DOCUMENT  
TRANSLATION, SCALING, AND ROTATION  
ON A TOUCH-SCREEN DISPLAY**

RELATED APPLICATIONS

This application claims priority to U.S. Provisional Patent Application Nos. 60/937,993, "Portable Multifunction Device," filed Jun. 29, 2007; 60/946,971, "List Scrolling and Document Translation, Scaling, and Rotation on a Touch-Screen Display," filed Jun. 28, 2007; 60/945,858, "List Scrolling and Document Translation on a Touch-Screen Display," filed Jun. 22, 2007; 60/879,469, "Portable Multifunction Device," filed Jan. 8, 2007; 60/883,801, "List Scrolling and Document Translation on a Touch-Screen Display," filed Jan. 7, 2007; and 60/879,253, "Portable Multifunction Device," filed Jan. 7, 2007. All of these applications are incorporated by reference herein in their entirety.

This application is related to the following applications: (1) U.S. patent application Ser. No. 10/188,182, "Touch Pad For Handheld Device," filed on Jul. 1, 2002; (2) U.S. patent application Ser. No. 10/722,948, "Touch Pad For Handheld Device," filed on Nov. 25, 2003; (3) U.S. patent application Ser. No. 10/643,256, "Movable Touch Pad With Added Functionality," filed on Aug. 18, 2003; (4) U.S. patent application Ser. No. 10/654,108, "Ambidextrous Mouse," filed on Sep. 2, 2003; (5) U.S. patent application Ser. No. 10/840,862, "Multipoint Touchscreen," filed on May 6, 2004; (6) U.S. patent application Ser. No. 10/903,964, "Gestures For Touch Sensitive Input Devices," filed on Jul. 30, 2004; (7) U.S. patent application Ser. No. 11/038,590, "Mode-Based Graphical User Interfaces For Touch Sensitive Input Devices" filed on Jan. 18, 2005; (8) U.S. patent application Ser. No. 11/057,050, "Display Actuator," filed on Feb. 11, 2005; (9) U.S. Provisional Patent Application No. 60/658,777, "Multi-Functional Hand-Held Device," filed Mar. 4, 2005; (10) U.S. patent application Ser. No. 11/367,749, "Multi-Functional Hand-Held Device," filed Mar. 3, 2006; and (11) U.S. Provisional Patent Application No. 60/824,769, "Portable Multifunction Device," filed Sep. 6, 2006. All of these applications are incorporated by reference herein in their entirety.

TECHNICAL FIELD

The disclosed embodiments relate generally to devices with touch-screen displays, and more particularly to scrolling lists and to translating, rotating, and scaling electronic documents on devices with touch-screen displays.

BACKGROUND

As portable electronic devices become more compact, and the number of functions performed by a given device increases, it has become a significant challenge to design a user interface that allows users to easily interact with a multifunction device. This challenge is particularly significant for handheld portable devices, which have much smaller screens than desktop or laptop computers. This situation is unfortunate because the user interface is the gateway through which users receive not only content but also responses to user actions or behaviors, including user attempts to access a device's features, tools, and functions. Some portable communication devices (e.g., mobile telephones, sometimes called mobile phones, cell phones, cellular telephones, and the like) have resorted to adding more pushbuttons, increasing the density of push buttons, overloading the functions of pushbuttons, or using complex menu systems to allow a user

2

to access, store and manipulate data. These conventional user interfaces often result in complicated key sequences and menu hierarchies that must be memorized by the user.

Many conventional user interfaces, such as those that include physical pushbuttons, are also inflexible. This is unfortunate because it may prevent a user interface from being configured and/or adapted by either an application running on the portable device or by users. When coupled with the time consuming requirement to memorize multiple key sequences and menu hierarchies, and the difficulty in activating a desired pushbutton, such inflexibility is frustrating to most users.

As a result of the small size of display screens on portable electronic devices and the potentially large size of electronic files, frequently only a portion of a list or of an electronic document of interest to a user can be displayed on the screen at a given time. Users thus will frequently need to scroll displayed lists or to translate displayed electronic documents. Users also will need to rotate and to scale (i.e., magnify or de-magnify) displayed electronic documents. However, the limitations of conventional user interfaces can cause these actions to be awkward to perform.

Furthermore, scrolling displayed lists and translating electronic documents can be awkward on both portable and non-portable electronic devices with touch-screen displays. A user may become frustrated if the scrolling or translation does not reflect the user's intent. Similarly, a user may become frustrated if rotation and scaling of electronic documents does not reflect the user's intent.

Accordingly, there is a need for devices with touch-screen displays with more transparent and intuitive user interfaces for scrolling lists of items and for translating, rotating, and scaling electronic documents that are easy to use, configure, and/or adapt.

SUMMARY

The above deficiencies and other problems associated with user interfaces for portable devices and devices with touch-sensitive displays are reduced or eliminated by the disclosed device. In some embodiments, the device has a touch-sensitive display (also known as a "touch screen") with a graphical user interface (GUI), one or more processors, memory and one or more modules, programs or sets of instructions stored in the memory for performing multiple functions. In some embodiments, the user interacts with the GUI primarily through finger contacts and gestures on the touch-sensitive display. In some embodiments, the functions may include telephoning, video conferencing, e-mailing, instant messaging, blogging, digital photographing, digital videoing, web browsing, digital music playing, and/or digital video playing. Instructions for performing these functions may be included in a computer program product configured for execution by one or more processors.

In accordance with some embodiments, a computer-implemented method for use in conjunction with a device with a touch screen display is disclosed. In the method, a movement of an object on or near the touch screen display is detected. In response to detecting the movement, an electronic document displayed on the touch screen display is translated in a first direction. If an edge of the electronic document is reached while translating the electronic document in the first direction while the object is still detected on or near the touch screen display, an area beyond the edge of the document is displayed. After the object is no longer detected on or near the touch

US 7,469,381 B2

3

screen display, the document is translated in a second direction until the area beyond the edge of the document is no longer displayed.

In accordance with some embodiments, a graphical user interface on a device with a touch screen display is disclosed, comprising a portion of an electronic document displayed on the touch screen display and an area beyond an edge of the document. In the graphical user interface, in response to detecting a movement of an object on or near the touch screen display, the electronic document is translated in a first direction. If the edge of the electronic document is reached while translating the electronic document in the first direction while the object is still detected on or near the touch screen display, the area beyond the edge of the document is displayed. After the object is no longer detected on or near the touch screen display, the document is translated in a second direction until the area beyond the edge of the document is no longer displayed.

In accordance with some embodiments, a device is disclosed, comprising a touch screen display, one or more processors, memory, and one or more programs. The one or more programs are stored in the memory and configured to be executed by the one or more processors. The one or more programs include instructions for detecting a movement of an object on or near the touch screen display and instructions for translating an electronic document displayed on the touch screen display in a first direction, in response to detecting the movement. The one or more programs also include instructions for displaying an area beyond an edge of the electronic document if the edge of the electronic document is reached while translating the electronic document in the first direction while the object is still detected on or near the touch screen display. The one or more programs further include instructions for translating the document in a second direction until the area beyond the edge of the document is no longer displayed, after the object is no longer detected on or near the touch screen display.

In accordance with some embodiments, a computer-program product is disclosed, comprising a computer readable storage medium and a computer program mechanism embedded therein. The computer program mechanism comprises instructions, which when executed by a device with a touch screen display, cause the device to detect a movement of an object on or near the touch screen display and to translate an electronic document displayed on the touch screen display in a first direction, in response to detecting the movement. The instructions also cause the device to display an area beyond an edge of the electronic document if the edge of the electronic document is reached while translating the electronic document in the first direction while the object is still detected on or near the touch screen display. The instructions further cause the device to translate the document in a second direction until the area beyond the edge of the document is no longer displayed, after the object is no longer detected on or near the touch screen display.

In accordance with some embodiments, a device with a touch screen display is disclosed. The device comprises means for detecting a movement of an object on or near the touch screen display and means for translating an electronic document displayed on the touch screen display in a first direction, in response to detecting the movement. The device also comprises means for displaying an area beyond an edge of the electronic document if the edge of the electronic document is reached while translating the electronic document in the first direction while the object is still detected on or near the touch screen display. The device further comprises means for translating the document in a second direction until the

4

area beyond the edge of the document is no longer displayed, after the object is no longer detected on or near the touch screen display.

In accordance with some embodiments, a computer-implemented method for use in conjunction with a device with a touch screen display is disclosed. In the method, a movement of an object on or near the touch screen display is detected. In response to detecting the movement, a list of items displayed on the touch screen display is scrolled in a first direction. If a terminus of the list is reached while scrolling the list in the first direction while the object is still detected on or near the touch screen display, an area beyond the terminus of the list is displayed. After the object is no longer detected on or near the touch screen display, the list is scrolled in a second direction opposite the first direction until the area beyond the terminus of the list is no longer displayed.

In accordance with some embodiments, a graphical user interface on a device with a touch screen display is disclosed, comprising a portion of a list of items displayed on the touch screen display and an area beyond a terminus of the list. In response to detecting a movement of an object on or near the touch screen display, the list is scrolled in a first direction. If the terminus of the list is reached while scrolling the list in the first direction while the object is still detected on or near the touch screen display, the area beyond the terminus of the list is displayed. After the object is no longer detected on or near the touch screen display, the list is scrolled in a second direction opposite the first direction until the area beyond the terminus of the list is no longer displayed.

In accordance with some embodiments, a device is disclosed, comprising a touch screen display, one or more processors, memory, and one or more programs. The one or more programs are stored in the memory and configured to be executed by the one or more processors. The one or more programs include instructions for detecting a movement of an object on or near the touch screen display and instructions for scrolling a list of items displayed on the touch screen display in a first direction in response to detecting the movement. The one or more programs also include instructions for displaying an area beyond a terminus of the list if the terminus of the list is reached while scrolling the list in the first direction while the object is still detected on or near the touch screen display. The one or more programs further include instructions for scrolling the list in a second direction opposite the first direction until the area beyond the terminus of the list is no longer displayed, after the object is no longer detected on or near the touch screen display.

In accordance with some embodiments, a computer-program product is disclosed, comprising a computer readable storage medium and a computer program mechanism embedded therein. The computer program mechanism comprises instructions, which when executed by a device with a touch screen display, cause the device to detect a movement of an object on or near the touch screen display and to scroll a list of items displayed on the touch screen display in a first direction in response to detecting the movement. The instructions also cause the device to display an area beyond a terminus of the list if the terminus of the list is reached while scrolling the list in the first direction while the object is still detected on or near the touch screen display. The instructions further cause the device to scroll the list in a second direction opposite the first direction until the area beyond the terminus of the list is no longer displayed, after the object is no longer detected on or near the touch screen display.

In accordance with some embodiments, a device with a touch screen display is disclosed. The device comprises means for detecting a movement of an object on or near the



US 7,469,381 B2

5

touch screen display and means for scrolling a list of items displayed on the touch screen display in a first direction in response to detecting the movement. The device also comprises means for displaying an area beyond a terminus of the list if the terminus of the list is reached while scrolling the list in the first direction while the object is still detected on or near the touch screen display. The device further comprises means for scrolling the list in a second direction opposite the first direction until the area beyond the terminus of the list is no longer displayed, after the object is no longer detected on or near the touch screen display.

In accordance with some embodiments, a computer-implemented method for use at a device with a touch screen display includes detecting a multifinger twisting gesture on or near the touch screen display. The multifinger twisting gesture has a corresponding degree of rotation. If the corresponding degree of rotation exceeds a predefined degree of rotation, a 90° screen rotation command is executed. If the corresponding degree of rotation is less than the predefined degree of rotation, a screen rotation command with an acute angle of rotation is executed and, upon ceasing to detect the multifinger twisting gesture, a screen rotation command with an angle of rotation opposite to the acute angle is executed.

In accordance with some embodiments, a device includes a touch screen display, one or more processors, memory, and one or more programs. The one or more programs are stored in the memory and configured to be executed by the one or more processors. The one or more programs include: instructions for detecting a multifinger twisting gesture on or near the touch screen display, wherein the multifinger twisting gesture has a corresponding degree of rotation; instructions for executing a 90° screen rotation command, if the corresponding degree of rotation exceeds a predefined degree of rotation; and instructions for executing a screen rotation command with an acute angle of rotation and for executing, upon ceasing to detect the multifinger twisting gesture, a screen rotation command with an angle of rotation opposite to the acute angle, if the corresponding degree of rotation is less than the predefined degree of rotation.

In accordance with some embodiments, a computer-program product includes a computer readable storage medium and a computer program mechanism embedded therein. The computer program mechanism includes instructions, which when executed by a device with a touch screen display, cause the device to: detect a multifinger twisting gesture on or near the touch screen display, wherein the multifinger twisting gesture has a corresponding degree of rotation; execute a 90° screen rotation command, if the corresponding degree of rotation exceeds a predefined degree of rotation; and execute a screen rotation command with an acute angle of rotation and, upon ceasing to detect the multifinger twisting gesture, execute a screen rotation command with an angle of rotation opposite to the acute angle, if the corresponding degree of rotation is less than the predefined degree of rotation.

In accordance with some embodiments, a device with a touch screen display includes: means for detecting a multifinger twisting gesture on or near the touch screen display, wherein the multifinger twisting gesture has a corresponding degree of rotation; means for executing a 90° screen rotation command, if the corresponding degree of rotation exceeds a predefined degree of rotation; and means for executing a screen rotation command with an acute angle of rotation and, upon ceasing to detect the multifinger twisting gesture, for executing a screen rotation command with an angle of rotation opposite to the acute angle, if the corresponding degree of rotation is less than the predefined degree of rotation.

6

In accordance with some embodiments, a computer-implemented method of displaying an electronic document having a document length and a document width, for use at a device with a touch screen display, includes displaying the electronic document at a first magnification and detecting a gesture on or near the touch screen display corresponding to a command to zoom out by a user-specified amount. In response to detecting the gesture, the electronic document is displayed at a magnification less than the first magnification. If the document length or document width is entirely displayed while the gesture is still detected on or near the touch screen display, the electronic document is displayed at a magnification wherein areas beyond opposite edges of the electronic document are displayed, and upon detecting termination of the gesture, the electronic document is displayed at a magnification wherein the areas beyond opposite edges of the electronic document are no longer displayed.

In accordance with some embodiments, a graphical user interface on a device with a touch screen display includes an electronic document having a document length and a document width, to be displayed on the touch screen display at multiple magnifications including a first magnification, and areas beyond opposite edges of the electronic document. In response to detecting a gesture on or near the touch screen display corresponding to a command to zoom out by a user-specified amount, wherein the gesture is detected while displaying the electronic document at the first magnification, the electronic document is displayed at a magnification less than the first magnification. If the document length or document width is entirely displayed while the gesture is still detected on or near the touch screen display, the electronic document is displayed at a magnification wherein the areas beyond opposite edges of the electronic document are displayed, and upon detecting termination of the gesture, the electronic document is displayed at a magnification wherein the areas beyond opposite edges of the electronic document are no longer displayed.

In accordance with some embodiments, a device includes a touch screen display, one or more processors, memory, and one or more programs. The one or more programs are stored in the memory and configured to be executed by the one or more processors. The one or more programs include: instructions for displaying an electronic document at a first magnification; instructions for detecting a gesture on or near the touch screen display corresponding to a command to zoom out by a user-specified amount; instructions for displaying the electronic document at a magnification less than the first magnification, in response to detecting the gesture; instructions for displaying the electronic document at a magnification wherein areas beyond opposite edges of the electronic document are displayed, if a document length or a document width is entirely displayed while the gesture is still detected on or near the touch screen display; and instructions for displaying the electronic document at a magnification wherein the areas beyond opposite edges of the electronic document are no longer displayed, upon detecting termination of the gesture.

In accordance with some embodiments, a computer-program product includes a computer readable storage medium and a computer program mechanism embedded therein. The computer program mechanism includes instructions, which when executed by a device with a touch screen display, cause the device to: display an electronic document at a first magnification; detect a gesture on or near the touch screen display corresponding to a command to zoom out by a user-specified amount; display the electronic document at a magnification less than the first magnification, in response to detecting the

US 7,469,381 B2

7

gesture; display the electronic document at a magnification wherein areas beyond opposite edges of the electronic document are displayed, if a document length or a document width is entirely displayed while the gesture is still detected on or near the touch screen display; and display the electronic document at a magnification wherein the areas beyond opposite edges of the electronic document are no longer displayed, upon detecting termination of the gesture.

In accordance with some embodiments, a device with a touch screen display includes: means for displaying an electronic document at a first magnification; means for detecting a gesture on or near the touch screen display corresponding to a command to zoom out by a user-specified amount; means for displaying the electronic document at a magnification less than the first magnification, in response to detecting the gesture; means for displaying the electronic document at a magnification wherein areas beyond opposite edges of the electronic document are displayed, if a document length or a document width is entirely displayed while the gesture is still detected on or near the touch screen display; and means for displaying the electronic document at a magnification wherein the areas beyond opposite edges of the electronic document are no longer displayed, upon detecting termination of the gesture.

In accordance with some embodiments, a computer-implemented method of displaying an electronic document, for use at a device with a touch screen display, includes displaying at least a first portion of the electronic document at a first magnification and detecting a gesture on or near the touch screen display corresponding to a command to zoom in by a user-specified amount. In response to detecting the gesture, decreasing portions of the electronic document are displayed at increasing magnifications. Upon detecting termination of the gesture, if the magnification exceeds a predefined magnification, a respective portion of the electronic document is displayed at the predefined magnification.

In accordance with some embodiments, a graphical user interface on a device with a touch screen display includes decreasing portions of an electronic document, to be displayed on the touch screen display at increasing magnifications. The decreasing portions of the electronic document include a first portion. In response to detecting a gesture on or near the touch screen display corresponding to a command to zoom in by a user-specified amount, wherein the gesture is detected while displaying at least the first portion of an electronic document at a first magnification, the decreasing portions of the electronic document are displayed at the increasing magnifications. Upon detecting termination of the gesture, if the magnification exceeds a predefined magnification, a respective portion of the electronic document is displayed at the predefined magnification.

In accordance with some embodiments, a device includes a touch screen display, one or more processors, memory, and one or more programs. The one or more programs are stored in the memory and configured to be executed by the one or more processors. The one or more programs include: instructions for displaying at least a first portion of an electronic document at a first magnification; instructions for detecting a gesture on or near the touch screen display corresponding to a command to zoom in by a user-specified amount; instructions for displaying decreasing portions of the electronic document at increasing magnifications, in response to detecting the gesture; and instructions for displaying a respective portion of the electronic document at a predefined magnification if, upon detecting termination of the gesture, the magnification exceeds the predefined magnification.

8

In accordance with some embodiments, a computer-program product includes a computer readable storage medium and a computer program mechanism embedded therein. The computer program mechanism includes instructions, which when executed by a device with a touch screen display, cause the device to: display at least a first portion of an electronic document at a first magnification; detect a gesture on or near the touch screen display corresponding to a command to zoom in by a user-specified amount; display decreasing portions of the electronic document at increasing magnifications, in response to detecting the gesture; and display a respective portion of the electronic document at a predefined magnification if, upon detecting termination of the gesture, the magnification exceeds a predefined magnification.

In accordance with some embodiments, a device with a touch screen display includes means for displaying at least a first portion of an electronic document at a first magnification; means for detecting a gesture on or near the touch screen display corresponding to a command to zoom in by a user-specified amount; means for displaying decreasing portions of the electronic document at increasing magnifications, in response to detecting the gesture; and means for displaying a respective portion of the electronic document at a predefined magnification if, upon detecting termination of the gesture, the magnification exceeds the predefined magnification.

The disclosed embodiments provide for easy and intuitive scrolling of lists and translating of electronic documents on a device with a touch screen display, and for easy and intuitive rotation and scaling of electronic documents on a device with a touch screen display.

#### BRIEF DESCRIPTION OF THE DRAWINGS

For a better understanding of the aforementioned embodiments of the invention as well as additional embodiments thereof, reference should be made to the Description of Embodiments below, in conjunction with the following drawings in which like reference numerals refer to corresponding parts throughout the figures.

FIG. 1 is a block diagram illustrating a portable multifunction device with a touch-sensitive display in accordance with some embodiments.

FIG. 2 illustrates a portable multifunction device having a touch screen in accordance with some embodiments.

FIG. 3 illustrates an exemplary user interface for unlocking a portable electronic device in accordance with some embodiments.

FIG. 4 illustrates an exemplary user interface for a menu of applications on a portable multifunction device in accordance with some embodiments.

FIG. 5 is a flow diagram illustrating a method of scrolling through a list in accordance with some embodiments.

FIGS. 6A-6D illustrate an exemplary user interface for managing an inbox in accordance with some embodiments.

FIG. 7 is a flow diagram illustrating a method of translating an electronic document in accordance with some embodiments.

FIGS. 8A-8D illustrate an exemplary user interface for a browser in accordance with some embodiments.

FIG. 9 is a flow diagram illustrating a process of displaying an electronic document at multiple magnifications in accordance with some embodiments.

FIGS. 10A-10C illustrate the display of an electronic document at multiple magnifications in accordance with some embodiments.

9

FIG. 11 is a flow diagram illustrating a process of displaying an electronic document at multiple magnifications in accordance with some embodiments.

FIGS. 12A-12C illustrate the display of an electronic document at multiple magnifications in accordance with some embodiments.

FIGS. 13A-13C illustrate the display of an electronic document at multiple magnifications in accordance with some embodiments.

FIG. 14 is a flow diagram illustrating a process of executing a screen rotation command in accordance with some embodiments.

FIGS. 15A-15E illustrate rotating the display of an electronic document or other digital object in accordance with some embodiments.

FIGS. 16A-16F illustrate an exemplary screen rotation gesture in accordance with some embodiments.

FIG. 17 is a block diagram illustrating a device with a touch-screen display in accordance with some embodiments.

#### DESCRIPTION OF EMBODIMENTS

Reference will now be made in detail to embodiments, examples of which are illustrated in the accompanying drawings. In the following detailed description, numerous specific details are set forth in order to provide a thorough understanding of the present invention. However, it will be apparent to one of ordinary skill in the art that the present invention may be practiced without these specific details. In other instances, well-known methods, procedures, components, circuits, and networks have not been described in detail so as not to unnecessarily obscure aspects of the embodiments.

Embodiments of a portable multifunction device, user interfaces for such devices, and associated processes for using such devices are described. In some embodiments, the device is a portable communications device such as a mobile telephone that also contains other functions, such as PDA and/or music player functions.

The user interface may include a physical click wheel in addition to a touch screen or a virtual click wheel displayed on the touch screen. A click wheel is a user-interface device that may provide navigation commands based on an angular displacement of the wheel or a point of contact with the wheel by a user of the device. A click wheel may also be used to provide a user command corresponding to selection of one or more items, for example, when the user of the device presses down on at least a portion of the wheel or the center of the wheel. Alternatively, breaking contact with a click wheel image on a touch screen surface may indicate a user command corresponding to selection. For simplicity, in the discussion that follows, a portable multifunction device that includes a touch screen is used as an exemplary embodiment. It should be understood, however, that some of the user interfaces and associated processes may be applied to other devices, such as personal computers and laptop computers, that may include one or more other physical user-interface devices, such as a physical click wheel, a physical keyboard, a mouse and/or a joystick.

The device supports a variety of applications, such as a telephone application, a video conferencing application, an e-mail application, an instant messaging application, a blogging application, a digital camera application, a digital video camera application, a web browsing application, a digital music player application, and/or a digital video player application.

The various applications that may be executed on the device may use at least one common physical user-interface

10

device, such as the touch screen. One or more functions of the touch screen as well as corresponding information displayed on the device may be adjusted and/or varied from one application to the next and/or within a respective application. In this way, a common physical architecture (such as the touch screen) of the device may support the variety of applications with user interfaces that are intuitive and transparent.

The user interfaces may include one or more soft keyboard embodiments. The soft keyboard embodiments may include standard (QWERTY) and/or non-standard configurations of symbols on the displayed icons of the keyboard, such as those described in U.S. patent applications Ser. No. 11/459,606, "Keyboards For Portable Electronic Devices," filed Jul. 24, 2006, and Ser. No. 11/459,615, "Touch Screen Keyboards For Portable Electronic Devices," filed Jul. 24, 2006, the contents of which are hereby incorporated by reference herein in their entirety. The keyboard embodiments may include a reduced number of icons (or soft keys) relative to the number of keys in existing physical keyboards, such as that for a typewriter. This may make it easier for users to select one or more icons in the keyboard, and thus, one or more corresponding symbols. The keyboard embodiments may be adaptive. For example, displayed icons may be modified in accordance with user actions, such as selecting one or more icons and/or one or more corresponding symbols. One or more applications on the portable device may utilize common and/or different keyboard embodiments. Thus, the keyboard embodiment used may be tailored to at least some of the applications. In some embodiments, one or more keyboard embodiments may be tailored to a respective user. For example, based on a word usage history (lexicography, slang, individual usage) of the respective user. Some of the keyboard embodiments may be adjusted to reduce a probability of a user error when selecting one or more icons, and thus one or more symbols, when using the soft keyboard embodiments.

Attention is now directed towards embodiments of the device. FIG. 1 is a block diagram illustrating a portable multifunction device 100 with a touch-sensitive display 112 in accordance with some embodiments. The touch-sensitive display 112 is sometimes called a "touch screen" for convenience. The device 100 may include a memory 102 (which may include one or more computer readable storage mediums), a memory controller 122, one or more processing units (CPU's) 120, a peripherals interface 118, RF circuitry 108, audio circuitry 110, a speaker 111, a microphone 113, an input/output (I/O) subsystem 106, other input or control devices 116, and an external port 124. The device 100 may include one or more optical sensors 164. These components may communicate over one or more communication buses or signal lines 103.

It should be appreciated that the device 100 is only one example of a portable multifunction device 100, and that the device 100 may have more or fewer components than shown, may combine two or more components, or a may have a different configuration or arrangement of the components. The various components shown in FIG. 1 may be implemented in hardware, software or a combination of both hardware and software, including one or more signal processing and/or application specific integrated circuits.

Memory 102 may include high-speed random access memory and may also include non-volatile memory, such as one or more magnetic disk storage devices, flash memory devices, or other non-volatile solid-state memory devices. Access to memory 102 by other components of the device 100, such as the CPU 120 and the peripherals interface 118, may be controlled by the memory controller 122.

## 11

The peripherals interface **118** couples the input and output peripherals of the device to the CPU **120** and memory **102**. The one or more processors **120** run or execute various software programs and/or sets of instructions stored in memory **102** to perform various functions for the device **100** and to process data.

In some embodiments, the peripherals interface **118**, the CPU **120**, and the memory controller **122** may be implemented on a single chip, such as a chip **104**. In some other embodiments, they may be implemented on separate chips.

The RF (radio frequency) circuitry **108** receives and sends RF signals, also called electromagnetic signals. The RF circuitry **108** converts electrical signals to/from electromagnetic signals and communicates with communications networks and other communications devices via the electromagnetic signals. The RF circuitry **108** may include well-known circuitry for performing these functions, including but not limited to an antenna system, an RF transceiver, one or more amplifiers, a tuner, one or more oscillators, a digital signal processor, a CODEC chipset, a subscriber identity module (SIM) card, memory, and so forth. The RF circuitry **108** may communicate with networks, such as the Internet, also referred to as the World Wide Web (WWW), an intranet and/or a wireless network, such as a cellular telephone network, a wireless local area network (LAN) and/or a metropolitan area network (MAN), and other devices by wireless communication. The wireless communication may use any of a plurality of communications standards, protocols and technologies, including but not limited to Global System for Mobile Communications (GSM), Enhanced Data GSM Environment (EDGE), wideband code division multiple access (W-CDMA), code division multiple access (CDMA), time division multiple access (TDMA), Bluetooth, Wireless Fidelity (Wi-Fi) (e.g., IEEE 802.11a, IEEE 802.11b, IEEE 802.11g and/or IEEE 802.11n), voice over Internet Protocol (VoIP), Wi-MAX, a protocol for email, instant messaging, and/or Short Message Service (SMS)), or any other suitable communication protocol, including communication protocols not yet developed as of the filing date of this document.

The audio circuitry **110**, the speaker **111**, and the microphone **113** provide an audio interface between a user and the device **100**. The audio circuitry **110** receives audio data from the peripherals interface **118**, converts the audio data to an electrical signal, and transmits the electrical signal to the speaker **111**. The speaker **111** converts the electrical signal to human-audible sound waves. The audio circuitry **110** also receives electrical signals converted by the microphone **113** from sound waves. The audio circuitry **110** converts the electrical signal to audio data and transmits the audio data to the peripherals interface **118** for processing. Audio data may be retrieved from and/or transmitted to memory **102** and/or the RF circuitry **108** by the peripherals interface **118**. In some embodiments, the audio circuitry **110** also includes a headset jack (not shown). The headset jack provides an interface between the audio circuitry **110** and removable audio input/output peripherals, such as output-only headphones or a headset with both output (e.g., a headphone for one or both ears) and input (e.g., a microphone).

The I/O subsystem **106** couples input/output peripherals on the device **100**, such as the display system **112** and other input/control devices **116**, to the peripherals interface **118**. The I/O subsystem **106** may include a display controller **156** and one or more input controllers **160** for other input or control devices. The one or more input controllers **160** receive/send electrical signals from/to other input or control devices **116**. The other input/control devices **116** may include physical buttons (e.g., push buttons, rocker buttons, etc.),

## 12

dials, slider switches, joysticks, click wheels, and so forth. In some alternate embodiments, input controller(s) **160** may be coupled to any (or none) of the following: a keyboard, infrared port, USB port, and a pointer device such as a mouse. The one or more buttons (e.g., **208**, FIG. 2) may include an up/down button for volume control of the speaker **111** and/or the microphone **113**. The one or more buttons may include a push button (e.g., **206**, FIG. 2). A quick press of the push button may disengage a lock of the touch screen **112** or begin a process that uses gestures on the touch screen to unlock the device, as described in U.S. patent application Ser. No. 11/322,549, "Unlocking a Device by Performing Gestures on an Unlock Image," filed Dec. 23, 2005, which is hereby incorporated by reference herein in its entirety. A longer press of the push button (e.g., **206**) may turn power to the device **100** on or off. The user may be able to customize a functionality of one or more of the buttons. The touch screen **112** is used to implement virtual or soft buttons and one or more soft keyboards.

The touch-sensitive display system **112** provides an input interface and an output interface between the device and a user. The display controller **156** receives and/or sends electrical signals from/to the display system **112**. The display system **112** displays visual output to the user. The visual output may include graphics, text, icons, video, and any combination thereof (collectively termed "graphics"). In some embodiments, some or all of the visual output may correspond to user-interface objects, further details of which are described below.

A touch screen in display system **112** is a touch-sensitive surface that accepts input from the user based on haptic and/or tactile contact. The display system **112** and the display controller **156** (along with any associated modules and/or sets of instructions in memory **102**) detect contact (and any movement or breaking of the contact) on the display system **112** and converts the detected contact into interaction with user-interface objects (e.g., one or more soft keys, icons, web pages or images) that are displayed on the touch screen. In an exemplary embodiment, a point of contact between a touch screen in the display system **112** and the user corresponds to a finger of the user.

The touch screen in the display system **112** may use LCD (liquid crystal display) technology, or LPD (light emitting polymer display) technology, although other display technologies may be used in other embodiments. The touch screen in the display system **112** and the display controller **156** may detect contact and any movement or breaking thereof using any of a plurality of touch sensing technologies now known or later developed, including but not limited to capacitive, resistive, infrared, and surface acoustic wave technologies, as well as other proximity sensor arrays or other elements for determining one or more points of contact with a touch screen in the display system **112**. A touch-sensitive display in some embodiments of the display system **112** may be analogous to the multi-touch sensitive tablets described in the following U.S. Pat. Nos. 6,323,846 (Westerman et al.), 6,570,557 (Westerman et al.), and/or 6,677,932 (Westerman), and/or U.S. Patent Publication 2002/0015024A1, each of which is hereby incorporated by reference herein in their entirety. However, a touch screen in the display system **112** displays visual output from the portable device **100**, whereas touch sensitive tablets do not provide visual output. The touch screen in the display system **112** may have a resolution in excess of 100 dpi. In an exemplary embodiment, the touch screen in the display system has a resolution of approximately 168 dpi. The user may make contact with the touch screen in the display system **112** using any suitable object or append-

## 13

age, such as a stylus, a finger, and so forth. In some embodiments, the user interface is designed to work primarily with finger-based contacts and gestures, which are much less precise than stylus-based input due to the larger area of contact of a finger on the touch screen. In some embodiments, the device translates the rough finger-based input into a precise pointer/cursor position or command for performing the actions desired by the user.

A touch-sensitive display in some embodiments of the display system **112** may be as described in the following applications: (1) U.S. patent application Ser. No. 11/381,313, "Multipoint Touch Surface Controller," filed on May 2, 2006; (2) U.S. patent application Ser. No. 10/840,862, "Multipoint Touchscreen," filed on May 6, 2004; (3) U.S. patent application Ser. No. 10/903,964, "Gestures For Touch Sensitive Input Devices," filed on Jul. 30, 2004; (4) U.S. patent application Ser. No. 11/048,264, "Gestures For Touch Sensitive Input Devices," filed on Jan. 31, 2005; (5) U.S. patent application Ser. No. 11/038,590, "Mode-Based Graphical User Interfaces For Touch Sensitive Input Devices," filed on Jan. 18, 2005; (6) U.S. patent application Ser. No. 11/228,758, "Virtual Input Device Placement On A Touch Screen User Interface," filed on Sep. 16, 2005; (7) U.S. patent application Ser. No. 11/228,700, "Operation Of A Computer With A Touch Screen Interface," filed on Sep. 16, 2005; (8) U.S. patent application Ser. No. 11/228,737, "Activating Virtual Keys Of A Touch-Screen Virtual Keyboard," filed on Sep. 16, 2005; and (9) U.S. patent application Ser. No. 11/367,749, "Multi-Functional Hand-Held Device," filed on Mar. 3, 2006. All of these applications are incorporated by reference herein in their entirety.

In some embodiments, in addition to the touch screen, the device **100** may include a touchpad (not shown) for activating or deactivating particular functions. In some embodiments, the touchpad is a touch-sensitive area of the device that, unlike the touch screen, does not display visual output. The touchpad may be a touch-sensitive surface that is separate from the touch screen in the display system **112** or an extension of the touch-sensitive surface formed by the touch screen.

In some embodiments, the device **100** may include a physical or virtual click wheel as an input control device **116**. A user may navigate among and interact with one or more graphical objects (henceforth referred to as icons) displayed in the display system **112** by rotating the click wheel or by moving a point of contact with the click wheel (e.g., where the amount of movement of the point of contact is measured by its angular displacement with respect to a center point of the click wheel). The click wheel may also be used to select one or more of the displayed icons. For example, the user may press down on at least a portion of the click wheel or an associated button. User commands and navigation commands provided by the user via the click wheel may be processed by an input controller **160** as well as one or more of the modules and/or sets of instructions in memory **102**. For a virtual click wheel, the click wheel and click wheel controller may be part of the display system **112** and the display controller **156**, respectively. For a virtual click wheel, the click wheel may be either an opaque or semitransparent object that appears and disappears on the touch screen display in response to user interaction with the device. In some embodiments, a virtual click wheel is displayed on the touch screen of a portable multifunction device and operated by user contact with the touch screen.

The device **100** also includes a power system **162** for powering the various components. The power system **162** may include a power management system, one or more power

## 14

sources (e.g., battery, alternating current (AC)), a recharging system, a power failure detection circuit, a power converter or inverter, a power status indicator (e.g., a light-emitting diode (LED)) and any other components associated with the generation, management and distribution of power in portable devices.

The device **100** may also include one or more optical sensors **164**. FIG. 1 shows an optical sensor coupled to an optical sensor controller **158** in I/O subsystem **106**. The optical sensor **164** may include charge-coupled device (CCD) or complementary metal-oxide semiconductor (CMOS) phototransistors. The optical sensor **164** receives light from the environment, projected through one or more lens, and converts the light to data representing an image. In conjunction with an imaging module **143**, the optical sensor **164** may capture still images or video. In some embodiments, an optical sensor is located on the back of the device **100**, opposite the touch screen display **112** on the front of the device, so that the touch screen display may be used as a viewfinder for either still and/or video image acquisition. In some embodiments, an optical sensor is located on the front of the device so that the user's image may be obtained for videoconferencing while the user views the other video conference participants on the touch screen display. In some embodiments, the position of the optical sensor **164** can be changed by the user (e.g., by rotating the lens and the sensor in the device housing) so that a single optical sensor **164** may be used along with the touch screen display for both video conferencing and still and/or video image acquisition.

The device **100** may also include one or more proximity sensors **166**. FIG. 1 shows a proximity sensor **166** coupled to the peripherals interface **118**. Alternately, the proximity sensor **166** may be coupled to an input controller **160** in the I/O subsystem **106**. The proximity sensor **166** may perform as described in U.S. patent application Ser. Nos. 11/241,839, "Proximity Detector In Handheld Device," filed Sep. 30, 2005, and 11/240,788, "Proximity Detector In Handheld Device," filed Sep. 30, 2005, which are hereby incorporated by reference herein in their entirety. In some embodiments, the proximity sensor turns off and disables the touch screen **112** when the multifunction device is placed near the user's ear (e.g., when the user is making a phone call). In some embodiments, the proximity sensor keeps the screen off when the device is in the user's pocket, purse, or other dark area to prevent unnecessary battery drainage when the device is a locked state.

In some embodiments, the software components stored in memory **102** may include an operating system **126**, a communication module (or set of instructions) **128**, a contact/motion module (or set of instructions) **130**, a graphics module (or set of instructions) **132**, a text input module (or set of instructions) **134**, a Global Positioning System (GPS) module (or set of instructions) **135**, and applications (or set of instructions) **136**.

The operating system **126** (e.g., Darwin, RTXC, LINUX, UNIX, OS X, WINDOWS, or an embedded operating system such as VxWorks) includes various software components and/or drivers for controlling and managing general system tasks (e.g., memory management, storage device control, power management, etc.) and facilitates communication between various hardware and software components.

The communication module **128** facilitates communication with other devices over one or more external ports **124** and also includes various software components for handling data received by the RF circuitry **108** and/or the external port **124**. The external port **124** (e.g., Universal Serial Bus (USB), FIREWIRE, etc.) is adapted for coupling directly to other

## 15

devices or indirectly over a network (e.g., the Internet, wireless LAN, etc.). In some embodiments, the external port is a multi-pin (e.g., 30-pin) connector that is the same as, or similar to and/or compatible with the 30-pin connector used on iPod (trademark of Apple Computer, Inc.) devices.

The contact/motion module 130 may detect contact with the touch screen in the display system 112 (in conjunction with the display controller 156) and other touch sensitive devices (e.g., a touchpad or physical click wheel). The contact/motion module 130 includes various software components for performing various operations related to detection of contact, such as determining if contact has occurred, determining if there is movement of the contact and tracking the movement across the touch screen in the display system 112, and determining if the contact has been broken (i.e., if the contact has ceased). Determining movement of the point of contact may include determining speed (magnitude), velocity (magnitude and direction), and/or an acceleration (a change in magnitude and/or direction) of the point of contact. These operations may be applied to single contacts (e.g., one finger contacts) or to multiple simultaneous contacts (e.g., "multi-touch"/multiple finger contacts). In some embodiments, the contact/motion module 130 and the display controller 156 also detects contact on a touchpad. In some embodiments, the contact/motion module 130 detects movement of one or more objects on or near the touch screen and/or the touchpad. In some embodiments, the contact/motion module 130 and the controller 160 detects contact on a click wheel 116.

The graphics module 132 includes various known software components for rendering and displaying graphics on the display system 112, including components for changing the intensity of graphics that are displayed. As used herein, the term "graphics" includes any object that can be displayed to a user, including without limitation text, web pages, icons (such as user-interface objects including soft keys), digital images, videos, animations and the like.

The text input module 134, which may be a component of graphics module 132, provides soft keyboards for entering text in various applications (e.g., contacts 137, e-mail 140, IM 141, blogging 142, browser 147, and any other application that needs text input).

The GPS module 135 determines the location of the device and provides this information for use in various applications (e.g., to telephone 138 for use in location-based dialing, to camera 143 and/or blogger 142 as picture/video metadata, and to applications that provide location-based services such as weather widgets, local yellow page widgets, and map/navigation widgets).

The applications 136 may include the following modules (or sets of instructions), or a subset or superset thereof:

- a contacts module 137 (sometimes called an address book or contact list);
- a telephone module 138;
- a video conferencing module 139;
- an e-mail client module 140;
- an instant messaging (IM) module 141;
- a blogging module 142;
- a camera module 143 for still and/or video images;
- an image management module 144;
- a video player module 145;
- a music player module 146;
- a browser module 147;
- a calendar module 148;
- widget modules 149, which may include weather widget 149-1, stocks widget 149-2, calculator widget 149-3,

## 16

alarm clock widget 149-4, dictionary widget 149-5, and other widgets obtained by the user, as well as user-created widgets 149-6;

widget creator module 150 for making user-created widgets 149-6; and/or search module 151.

Examples of other applications 136 that may be stored in memory 102 include memo pad and other word processing applications, JAVA-enabled applications, encryption, digital rights management, voice recognition, and voice replication.

In conjunction with display system 112, display controller 156, contact module 130, graphics module 132, and text input module 134, the contacts module 137 may be used to manage an address book or contact list, including: adding name(s) to the address book; deleting name(s) from the address book; associating telephone number(s), e-mail address(es), physical address(es) or other information with a name; associating an image with a name; categorizing and sorting names; providing telephone numbers or e-mail addresses to initiate and/or facilitate communications by telephone 138, video conference 139, e-mail 140, or IM 141; and so forth.

In conjunction with RF circuitry 108, audio circuitry 110, speaker 111, microphone 113, display system 112, display controller 156, contact module 130, graphics module 132, and text input module 134, the telephone module 138 may be used to enter a sequence of characters corresponding to a telephone number, access one or more telephone numbers in the address book 137, modify a telephone number that has been entered, dial a respective telephone number, conduct a conversation and disconnect or hang up when the conversation is completed. As noted above, the wireless communication may use any of a plurality of communications standards, protocols and technologies.

In conjunction with RF circuitry 108, audio circuitry 110, speaker 111, microphone 113, display system 112, display controller 156, optical sensor 164, optical sensor controller 158, contact module 130, graphics module 132, text input module 134, contact list 137, and telephone module 138, the videoconferencing module 139 may be used to initiate, conduct, and terminate a video conference between a user and one or more other participants.

In conjunction with RF circuitry 108, display system 112, display controller 156, contact module 130, graphics module 132, and text input module 134, the e-mail client module 140 may be used to create, send, receive, and manage e-mail. In conjunction with image management module 144, the e-mail module 140 makes it very easy to create and send e-mails with still or video images taken with camera module 143.

In conjunction with RF circuitry 108, display system 112, display controller 156, contact module 130, graphics module 132, and text input module 134, the instant messaging module 141 may be used to enter a sequence of characters corresponding to an instant message, to modify previously entered characters, to transmit a respective instant message (for example, using a Short Message Service (SMS) or Multimedia Message Service (MMS) protocol), to receive instant messages and to view received instant messages. In some embodiments, transmitted and/or received instant messages may include graphics, photos, audio files, video files and/or other attachments as are supported in a MMS and/or an Enhanced Messaging Service (EMS).

In conjunction with RF circuitry 108, display system 112, display controller 156, contact module 130, graphics module 132, text input module 134, image management module 144, and browsing module 147, the blogging module 142 may be used to send text, still images, video, and/or other graphics to a blog (e.g., the user's blog).

US 7,469,381 B2

17

In conjunction with display system **112**, display controller **156**, optical sensor(s) **164**, optical sensor controller **158**, contact module **130**, graphics module **132**, and image management module **144**, the camera module **143** may be used to capture still images or video (including a video stream) and store them into memory **102**, modify characteristics of a still image or video, or delete a still image or video from memory **102**.

In conjunction with display system **112**, display controller **156**, contact module **130**, graphics module **132**, text input module **134**, and camera module **143**, the image management module **144** may be used to arrange, modify or otherwise manipulate, label, delete, present (e.g., in a digital slide show or album), and store still and/or video images.

In conjunction with display system **112**, display controller **156**, contact module **130**, graphics module **132**, audio circuitry **110**, and speaker **111**, the video player module **145** may be used to display, present or otherwise play back videos (e.g., on the touch screen or on an external, connected display via external port **124**).

In conjunction with display system **112**, display system controller **156**, contact module **130**, graphics module **132**, audio circuitry **110**, speaker **111**, RF circuitry **108**, and browser module **147**, the music player module **146** allows the user to download and play back recorded music and other sound files stored in one or more file formats, such as MP3 or AAC files. In some embodiments, the device **100** may include the functionality of an MP3 player, such as an iPod (trademark of Apple Computer, Inc.).

In conjunction with RF circuitry **108**, display system **112**, display system controller **156**, contact module **130**, graphics module **132**, and text input module **134**, the browser module **147** may be used to browse the Internet, including searching, linking to, receiving, and displaying web pages or portions thereof, as well as attachments and other files linked to web pages.

In conjunction with RF circuitry **108**, display system **112**, display system controller **156**, contact module **130**, graphics module **132**, text input module **134**, e-mail module **140**, and browser module **147**, the calendar module **148** may be used to create, display, modify, and store calendars and data associated with calendars (e.g., calendar entries, to do lists, etc.).

In conjunction with RF circuitry **108**, display system **112**, display system controller **156**, contact module **130**, graphics module **132**, text input module **134**, and browser module **147**, the widget modules **149** are mini-applications that may be downloaded and used by a user (e.g., weather widget **149-1**, stocks widget **149-2**, calculator widget **149-3**, alarm clock widget **149-4**, and dictionary widget **149-5**) or created by the user (e.g., user-created widget **149-6**). In some embodiments, a widget includes an HTML (Hypertext Markup Language) file, a CSS (Cascading Style Sheets) file, and a JavaScript file. In some embodiments, a widget includes an XML (Extensible Markup Language) file and a JavaScript file (e.g., Yahoo! Widgets).

In conjunction with RF circuitry **108**, display system **112**, display system controller **156**, contact module **130**, graphics module **132**, text input module **134**, and browser module **147**, the widget creator module **150** may be used by a user to create widgets (e.g., turning a user-specified portion of a web page into a widget).

In conjunction with display system **112**, display system controller **156**, contact module **130**, graphics module **132**, and text input module **134**, the search module **151** may be used to search for text, music, sound, image, video, and/or other files in memory **102** that match one or more search criteria (e.g., one or more user-specified search terms).

18

Each of the above identified modules and applications correspond to a set of instructions for performing one or more functions described above. These modules (i.e., sets of instructions) need not be implemented as separate software programs, procedures or modules, and thus various subsets of these modules may be combined or otherwise re-arranged in various embodiments. In some embodiments, memory **102** may store a subset of the modules and data structures identified above. Furthermore, memory **102** may store additional modules and data structures not described above.

In some embodiments, the device **100** is a device where operation of a predefined set of functions on the device is performed exclusively through a touch screen in the display system **112** and/or a touchpad. By using a touch screen and/or a touchpad as the primary input/control device for operation of the device **100**, the number of physical input/control devices (such as push buttons, dials, and the like) on the device **100** may be reduced.

The predefined set of functions that may be performed exclusively through a touch screen and/or a touchpad includes navigation between user interfaces. In some embodiments, the touchpad, when touched by the user, navigates the device **100** to a main, home, or root menu from any user interface that may be displayed on the device **100**. In such embodiments, the touchpad may be referred to as a "menu button." In some other embodiments, the menu button may be a physical push button or other physical input/control device instead of a touchpad.

FIG. 2 illustrates a portable multifunction device **100** having a touch screen **112** in accordance with some embodiments. The touch screen may display one or more graphics. In this embodiment, as well as others described below, a user may select one or more of the graphics by making contact or touching the graphics, for example, with one or more fingers **202** (not drawn to scale in the figure). In some embodiments, selection of one or more graphics occurs when the user breaks contact with the one or more graphics. In some embodiments, the contact may include a gesture, such as one or more taps, one or more swipes (from left to right, right to left, upward and/or downward) and/or a rolling of a finger (from right to left, left to right, upward and/or downward) that has made contact with the device **100**. In some embodiments, inadvertent contact with a graphic may not select the graphic. For example, a swipe gesture that sweeps over an application icon may not select the corresponding application when the gesture corresponding to selection is a tap.

The device **100** may also include one or more physical buttons, such as "home" or menu button **204**. As described previously, the menu button **204** may be used to navigate to any application **136** in a set of applications that may be executed on the device **100**. Alternatively, in some embodiments, the menu button is implemented as a soft key in a GUI in touch screen **112**.

In one embodiment, the device **100** includes a touch screen **112**, a menu button **204**, a push button **206** for powering the device on/off and locking the device, and volume adjustment button(s) **208**. The push button **206** may be used to turn the power on/off on the device by depressing the button and holding the button in the depressed state for a predefined time interval; to lock the device by depressing the button and releasing the button before the predefined time interval has elapsed; and/or to unlock the device or initiate an unlock process. In an alternative embodiment, the device **100** also may accept verbal input for activation or deactivation of some functions through the microphone **113**.

Attention is now directed towards embodiments of user interfaces ("UI") and associated processes that may be imple-

## US 7,469,381 B2

19

mented on a portable multifunction device **100** and/or on a device **1700** with a touch-screen display (FIG. 17).

FIG. 3 illustrates an exemplary user interface for unlocking a portable electronic device in accordance with some embodiments. In some embodiments, user interface **300** includes the following elements, or a subset or superset thereof:

Unlock image **302** that is moved with a finger gesture to unlock the device;  
 Arrow **304** that provides a visual cue to the unlock gesture;  
 Channel **306** that provides additional cues to the unlock gesture;  
 Time **308**;  
 Day **310**;  
 Date **312**; and  
 Wallpaper image **314**.

In some embodiments, the device detects contact with the touch-sensitive display (e.g., a user's finger making contact on or near the unlock image **302**) while the device is in a user-interface lock state. The device moves the unlock image **302** in accordance with the contact. The device transitions to a user-interface unlock state if the detected contact corresponds to a predefined gesture, such as moving the unlock image across channel **306**. Conversely, the device maintains the user-interface lock state if the detected contact does not correspond to the predefined gesture. As noted above, processes that use gestures on the touch screen to unlock the device are described in U.S. patent application Ser. No. 11/322,549, "Unlocking a Device by Performing Gestures on an Unlock Image," filed Dec. 23, 2005, which is hereby incorporated by reference herein in its entirety.

FIG. 4 illustrates an exemplary user interface for a menu of applications on a portable multifunction device in accordance with some embodiments. In some embodiments, user interface **400** includes the following elements, or a subset or superset thereof:

Signal strength indicator **402** for wireless communication;  
 Time **404**;  
 Battery status indicator **406**;  
 Tray **408** with icons for frequently used applications, such as one or more of the following:  
 Phone **138**;  
 E-mail client **140**, which may include an indicator **410** of the number of unread e-mails;  
 Browser **147**; and  
 Music player **146**; and  
 Icons for other applications, such as one or more of the following:  
 IM **141**;  
 Image management **144**;  
 Camera **143**;  
 Video player **145**;  
 Weather **149-1**;  
 Stocks **149-2**;  
 Blog **142**;  
 Calendar **148**;  
 Calculator **149-3**;  
 Alarm clock **149-4**;  
 Dictionary **149-5**; and  
 User-created widget **149-6**.

In some embodiments, UI **400** displays all of the available applications **136** on one screen so that there is no need to scroll through a list of applications (e.g., via a scroll bar or via a swipe gesture). In some embodiments, as the number of applications increases, the icons corresponding to the applications may decrease in size so that all applications may be displayed on a single screen without scrolling. In some embodiments, having all applications on one screen and a

20

menu button enables a user to access any desired application with at most two inputs, such as activating the menu button **204** and then activating the desired application (e.g., by a tap or other finger gesture on the icon corresponding to the application).

In some embodiments, UI **400** provides integrated access to both widget-based applications and non-widget-based applications. In some embodiments, all of the widgets, whether user-created or not, are displayed in UI **400**. In other embodiments, activating the icon for user-created widget **149-6** may lead to another UI (not shown) that contains the user-created widgets or icons corresponding to the user-created widgets.

In some embodiments, a user may rearrange the icons in UI **400**, e.g., using processes described in U.S. patent application Ser. No. 11/459,602, "Portable Electronic Device With Interface Reconfiguration Mode," filed Jul. 24, 2006, which is hereby incorporated by reference herein in its entirety. For example, a user may move application icons in and out of tray **408** using finger gestures.

In some embodiments, UI **400** includes a gauge (not shown) that displays an updated account usage metric for an account associated with usage of the device (e.g., a cellular phone account), as described in U.S. patent application Ser. No. 11/322,552, "Account Information Display For Portable Communication Device," filed Dec. 23, 2005, which is hereby incorporated by reference herein in its entirety.

As discussed above, UI **400** may display all of the available applications **136** on one screen so that there is no need to scroll through a list of applications. However, in some embodiments a touch-sensitive display may include a GUI with one or more windows that display only a portion of a list of items (e.g., information items) or of an electronic document. In response to detecting a movement of an object on or near the touch-sensitive display, the list may be scrolled or the electronic document may be translated. Detecting the movement of the object may include determining speed (magnitude), velocity (magnitude and direction), and/or an acceleration (including magnitude and/or direction) of the object. Scrolling through the list or translating the document may be accelerated in response to an accelerated movement of the object. In some embodiments, the scrolling and acceleration of the scrolling, or translation and acceleration of the translation, may be in accordance with a simulation of a physical device having friction, i.e., damped motion. For example, the scrolling or translation may correspond to a simulation of a force law or equation of motion having a mass or inertial term, as well as a dissipative term. In some embodiments, the simulation may correspond to a cylinder rotating about its axis.

In some embodiments, accelerated movement of the detected object may include an accelerated movement of a point of contact followed by a breaking of the point of contact. For example, the user may make contact with the touch-sensitive display, swipe or sweep one or more of his or her fingers along the display (i.e., move and/or accelerate the point of contact), and optionally, break the point of contact with the display, i.e., move the one or more fingers away from the display. The swipe or sweep may be along a predefined axis of the touch-sensitive display or may be within a predetermined angle of a predefined direction on the touch-sensitive display. In other embodiments, the accelerated movement of the point of contact may include a first user gesture oriented along a predefined axis of the touch-sensitive display or oriented within a predetermined angle of a predefined direction on the touch-sensitive display.



US 7,469,381 B2

21

Scrolling through the list of items or translating the electronic document may be further accelerated in response to detection of a second movement of an object on or near the touch-sensitive display, such as a second sweeping motion of the point of contact along the predefined axis or within the predetermined angle of a predefined direction on the touch-sensitive display and/or a second user gesture oriented along the predefined axis or within the predetermined angle of a predefined direction on the touch-sensitive display. For example, the user may swipe one or more of his or her fingers along the touch-sensitive display two or more times.

The scrolling through the list of items or the translation of the electronic document may be stopped in accordance with the user breaking the point of contact and then establishing a substantially stationary point of contact with the touch-sensitive display for at least a pre-determined period of time. For example, after swiping one or more of his or her fingers along the touch-sensitive display and breaking the point of contact, the user may touch the display and hold the one or more fingers that are touching the display stationary (or approximately stationary) for one or more seconds, or fractions of a second.

The direction of scrolling or translation may be reversed in response to intersecting a virtual boundary corresponding to a terminus of the list or an edge of the electronic document. The scrolling reversal or translation reversal may correspond to a damped motion. For example, during scrolling, a displayed portion of the list of items may appear to bounce off of a boundary of the window in the touch-sensitive display when a beginning or an end of the list of items is reached. Similarly, during translation, a displayed portion of the electronic document may appear to bounce off of a boundary of the window in the touch-sensitive display when an edge of the document is reached. The apparent bounce may correspond to a simulation of a viscous or elastic ball having momentum in a first direction striking an immovable and/or inelastic object, such as a wall. The subsequent motion of the document (the motion of which corresponds to the ball in the aforementioned analogy) may be damped, for example, by including a friction or dissipative term in the simulation. A parameter corresponding to the friction term in the simulation may be adjustable, allowing the document to reach equilibrium in contact with the virtual boundary, or displaced from the virtual boundary.

In some embodiments movement of the point of contact by the user over an index on the touch-sensitive display may be determined. In some embodiments, the index may be displayed in a first region or a first window of the touch-sensitive display while the list of items or information items during the scrolling may be displayed in a second region or a second window of the touch-sensitive display. The displayed index may have a sequence of index items. In an exemplary embodiment, the sequence of index items may include letters in the alphabet, i.e., the index may include an alphabetical index. The list of information items may include an alphabetically ordered list of information items. The alphabetically ordered list of information items may include contact information, for example, in a user's contact list or address book.

In response to movement of the user's point of contact over a displayed index, the list of information items on the touch-sensitive display may be scrolled. The list of information items may include a sequence of information item subsets corresponding to the sequence of index items. The subsets may include one or more categories. For example, a respective category may include contact information for one or more individuals whose first and/or last names begin with one or more respective letters, such as the letter 's'. In an exemplary embodiment, there is a subset corresponding to each

22

letter in the alphabet that has one or more entries. In some embodiments, the scrolling may be in accordance with a simulation of an equation of motion having friction.

The scrolling may include scrolling through a respective information item subset if the point of contact moves over a corresponding respective index item in the index items. The scrolling may have an associated scroll speed based on a speed of movement of the point of contact over the respective index item and the number of items in the information item subset corresponding to the respective index item. For example, the scroll speed may be faster for subsets that have more entries than subsets with fewer entries. The scrolling may include scrolling through all items in a plurality of the information item subsets in response to the point of contact moving over the corresponding index items in the displayed index.

If it is determined that the point of contact with the index corresponds to a respective index item in the index, the list of information items may be scrolled to a corresponding subset of the list of information items. For example, if the user selects an index item, such as the letter 'R', in the set of index symbols, the list of items may be smoothly scrolled to the corresponding subset for the letter 'R' in the list of items. Alternatively, the displayed list of information items jump directly from a current scroll position to a scroll position in which information items corresponding to the index item 'R' are displayed.

In the present document, the term "if" may be construed to mean "when," or "upon," or "in response to determining," or "in response to detecting," depending on the context. Similarly, the phrase "if it is determined" or "if [a stated condition or event] is detected" may be construed to mean "upon determining" or "in response to determining" or "upon detecting" the stated condition or event, or "in response to detecting" the stated condition or event, depending on the context.

If the point of contact with the touch-sensitive display corresponds to a user selection of a respective information item in the list of information items, information corresponding to the respective information item may be displayed on the touch-sensitive display. For example, if the user selects a respective name, the corresponding contact information may be displayed.

While scrolling through respective information subsets, an index symbol may be displayed in conjunction with each respective information item subset. In some embodiments, respective index symbols may be displayed adjacent to corresponding subsets (such as displayed text) of the list of information items. In some embodiments, a respective index symbol may be displayed at an upper edge of a window containing the displayed text of the respective information item subset.

The index symbol corresponding to a respective information subset may be translucently displayed over the respective information item subset. The translucently displayed index symbol may have a different font color than that used to display text in the information item subset, and/or it may be displayed using a larger font than the font used to display text in the information item subset.

If the list of information items contains no items for a particular index symbol, i.e., no entries for a particular subset, a first index symbol preceding a particular index symbol and a second index symbol following the index symbol may be displayed in conjunction with scrolling through the list of information items from the information subset corresponding to the first index symbol to the information subset corresponding to the second index symbol. The particular index symbol may not be displayed in conjunction with the displayed text of the list of information items during the scroll

through. For example, display of a respective index symbol may be skipped when the list of information items contains no items for the particular index symbol.

In some embodiments, the list scrolling described here operates without displaying a scroll bar. Similarly, in some embodiments, the translation of electronic documents described here operates without displaying scroll bars. The user's sweeping motion on the touch-sensitive display operation may be performed directly on top of the displayed list or displayed electronic document, and may include a sweeping or gliding motion, near or in contact with the display's surface, along a path anywhere within a display window in which the list or electronic document is displayed. While a scroll bar could potentially be displayed in conjunction with the displayed list, the scrolling or translation described here can be independent of any such scroll bar. In some embodiments, if a scroll bar is used, then an upward movement of a point of contact on the scroll bar may cause earlier entries in the list to be displayed, whereas a downward movement of the point of contact on the scroll bar may cause later entries in the list to be displayed.

In some embodiments, scrolling or translation may be in accordance with a speed of movement of a detected object, such as a speed of movement of a point of contact. The speed may be a time average of values determined during several time intervals. In an exemplary embodiment, the speed, velocity and/or acceleration may be determined over five time intervals, where a respective time interval corresponds to an inverse of a frame rate, such as 0.0167 s, of a display. In some embodiments, the speed, velocity and/or acceleration may be determined even when a variable frame rate is used, such as when one or more frames are skipped or not displayed. In these embodiments, the speed, velocity, and/or acceleration may be determined two or more times for the respective time interval and/or may be projected based on values determined in a preceding and/or a subsequent time interval.

In some embodiments, the scrolling or translation after a user optionally breaks the contact may be in accordance with the change in the acceleration and the speed or the velocity in one or more time intervals prior to the breaking of the contact. For example, the velocity  $v_f$  of scrolling or translation one or more time intervals after breaking contact may be determined using

$$v_f = v_o + a\Delta t,$$

where  $v_o$  is a current value of the velocity when the contact is broken,  $a$  is a current value of the acceleration when the contact is broken and  $\Delta t$  is an elapsed time, such as one time interval. The velocities and/or acceleration in such a calculation may be projected along an axis or direction of the scrolling or translation. In some embodiments, in subsequent time intervals following the determination of the velocity based on the acceleration and/or the velocity in one or more time intervals prior to the breaking of the contact, the velocity of the scrolling or translation may be tapered. For example, in each successive time interval the velocity may be decreased by 5%. When the velocity crosses a lower threshold, it may be set to zero.

FIG. 5 is a flow diagram illustrating a method 500 of scrolling through a list in accordance with some embodiments. The method 500 provides a simple visual indicator to a user that a terminus of a list has been reached.

Movement of an object is detected on or near a touch screen display of a device (502). In some embodiments, the object is a finger. In some embodiments, the device is a portable multifunction device.

In response to detecting the movement, a list of items displayed on the touch screen display is scrolled in a first direction (504). In some embodiments, the list is a list of email messages, as illustrated in FIGS. 6A-6D. In some embodiments, the list of items is a list of instant message conversations, a list of favorite phone numbers, a list of contact information (sometimes called a contact list or address book list), a list of labels, a list of email folders, a list of email addresses, a list of physical addresses, a list of ringtones, a list of album names, or a list of bookmarks. In some embodiments, the first direction is a vertical direction; in some other embodiments, the first direction is a horizontal direction. In some embodiments, scrolling the list in the first direction prior to reaching a terminus of the list has an associated scrolling speed corresponding to a speed of movement of the object (506). In some embodiments, the list is scrolled in accordance with a simulation of an equation of motion having friction (508).

If a terminus of the list is reached (e.g., upon reaching the terminus of the list) while scrolling the list in the first direction while the object is still detected on or near the touch screen display, an area beyond the terminus of the list is displayed (510-Yes, 514). In some embodiments, the list has a first item and a last item and the terminus is either the first item or the last item. For example, in FIG. 6B the email 3534 from Aaron Jones is the first item and thus the terminus of the corresponding list of emails. In some embodiments, the area beyond the terminus of the list is white (516). In some embodiments, the list of items has a background and the area beyond the terminus of the list is visually indistinct from the background (518). For example, in FIG. 6C both the area 3536 and the background of the listed emails are white.

After the object is no longer detected on or near the touch screen display, the list of items is scrolled in a second direction opposite the first direction until the area beyond the terminus of the list is no longer displayed (520). In some embodiments, the list is scrolled in the second direction using a damped motion (522). In some embodiments, the change from scrolling the list in the first direction to scrolling the list in the second direction until the area beyond the terminus of the list is no longer displayed makes the terminus of the list appear to be elastically attached to an edge of the touch screen display or to an edge displayed on the touch screen display (524).

In some embodiments, scrolling in the first direction prior to reaching the terminus of the list has a first associated scrolling distance that corresponds to a distance of movement of the object prior to reaching the terminus of the list. For example, a scrolling distance prior to reaching the terminus of the list shown in FIGS. 6A-6D may correspond to a distance traversed on the touch screen display by the swipe gesture 3514 before the terminus is reached. Displaying an area beyond the terminus of the list includes scrolling the list in the first direction for a second associated scrolling distance that is less than a distance of movement of the object after the terminus is reached. For example, in FIG. 6C, after the terminus is reached the list is scrolled for a distance 3538, which may be less than a distance traversed on the touch screen display by the swipe gesture 3514 after the terminus is reached.

In some embodiments, scrolling in the first direction prior to reaching a terminus of the list has a first associated scrolling speed that corresponds to a speed of movement of the object. For example, a scrolling speed prior to reaching the terminus of the list shown in FIGS. 6A-6D may correspond to a speed on the touch screen display of the swipe gesture 3514 before the terminus is reached. Displaying an area beyond the

25

terminus of the list includes scrolling the list in the first direction at a second associated scrolling speed. The second associated scrolling speed is slower than the first associated scrolling speed. For example, in FIG. 6C, displaying the area 3536 beyond the terminus of the list may include scrolling the list at a speed that is slower than the scrolling speed before the terminus is reached. In some embodiments, the second associated speed is a fraction (e.g., one-half or one-third) of the first associated speed. In some embodiments, the second associated speed is the square root of the first associated speed.

If a terminus of the list is not reached while scrolling the list in the first direction while the object is still detected on or near the touch screen display, the process 500 is complete (510-No, 512). The process 500 may be re-initiated upon subsequent detection of another movement of an object on or near the touch screen display (502).

FIGS. 6A-6D illustrate the scrolling of a list of items to a terminus of the list, at which point an area beyond the terminus is displayed and the list is then scrolled in an opposite direction until the area beyond the terminus is no longer displayed, in accordance with some embodiments. While FIGS. 6A-6D illustrate this scrolling in the context of a portable multifunction device 100, this scrolling is not limited to portable multifunction devices. In the example of FIGS. 6A-6D, the listed items are email messages; FIGS. 6A-6D illustrate an exemplary user interface 3500A for managing an inbox in accordance with some embodiments. An analogous user interface may be used to display and manage other mailboxes (e.g., drafts, sent, trash, personal, etc.). In addition, other types of lists are possible, including but not limited to lists of instant message conversations, favorite phone numbers, contact information, labels, email folders, email addresses, physical addresses, ringtones, album names or bookmarks.

In some embodiments, user interface 3500A include the following elements, or a subset or superset thereof:

402, 404, and 406, as described above;

a create email icon 3310 that when activated (e.g., by a finger tap on the icon) initiates display of a UI to create a new email message;

mailboxes icon 3502 that when activated (e.g., by a finger tap on the icon) initiates the display of a UI listing email mailboxes (i.e., folders);

unread messages icon 3504 that displays the number of unread messages in the inbox;

names 3506 of the senders of the email messages;

subject lines 3508 for the email messages;

dates 3510 of the email messages;

unread message icons 3512 that indicate messages that have not been opened;

preview pane separator 3518 that separates the list of messages from a preview of a selected message in the list;

settings icon 3520 that when activated (e.g., by a finger tap on the icon) initiates the display of a UI to modify settings;

move message icon 3522 that when activated (e.g., by a finger tap on the icon) initiates the display of a UI to move messages;

Delete symbol icon 3524 that when activated (e.g., by a finger tap on the icon) initiates display of a UI to confirm that the user wants to delete the selected email;

Reply/Forward icon 3526 that when activated (e.g., by a finger tap on the icon) initiates display of a UI to select how to reply or forward the selected email;

If the list of emails fills more than the allotted screen area, the user may scroll through the emails using vertically

26

upward and/or vertically downward swipe gestures on the touch screen. In the example of FIG. 6A, a portion of a list of emails is displayed in the screen area, including a top displayed email 3530 from Bruce Walker and a bottom displayed email 3532 from Kim Brook. A user performs a vertically downward swipe gesture 3514 to scroll toward the top of the list. The vertically downward gesture 3514, which may be a finger gesture, corresponds to the movement of an object on or near the touch screen that is detected in operation 502 of process 500 (FIG. 5). The vertically downward gesture 3514 need not be exactly vertical; a substantially vertical gesture is sufficient. In some embodiments, a gesture within a predetermined angle of being perfectly vertical results in vertical scrolling. In one embodiment, a gesture within 27 degrees of being perfectly vertical results in vertical scrolling.

As a result of detecting the vertically downward gesture 3514, in FIG. 6B the displayed emails have shifted down, such that the previous bottom displayed email 3532 from Kim Brook is no longer displayed, the previous top displayed email 3530 from Bruce Walker is now second from the top, and the email 3534 from Aaron Jones, which was not displayed in FIG. 6A, is now displayed at the top of the list. This shifting of emails is an example of the scrolling described in operation 504 of process 500 (FIG. 5).

In this example, the email 3534 from Aaron Jones is the first email in the list and thus is the terminus of the list. Upon reaching this email 3534, in response to continued detection of the vertically downward gesture 3514, an area 3536 (FIG. 6C) above the first email 3534 (i.e., beyond the terminus of the list) is displayed, as described in operation 514 of process 500 (FIG. 5). In some embodiments, the area displayed beyond the terminus of the list is visually indistinct from the background of the list, as described in operation 518 of process 500 (FIG. 5). In FIG. 6C, both the area 3536 and the background of the emails (e.g., emails 3534 and 3530) are white and thus are visually indistinct.

Once vertically downward gesture 3514 is complete, such that a corresponding object is no longer detected on or near the touch screen display, the list is scrolled in an opposite direction until the area 3536 is no longer displayed. FIG. 6D illustrates the result of this scrolling in the opposite direction, which corresponds to operation 520 of process 500 (FIG. 5): the email 3534 from Aaron Jones is now displayed at the top of the screen area allotted to the list and the area 3536 is not displayed.

In the example of FIGS. 6A-6D, a vertically downward gesture resulted in display of an area beyond the first item in the list. Similarly, a vertically upward gesture may result in display of an area beyond the last item of the list, if the vertically upward gesture continues once the list has been scrolled to the last item. The last item may be considered a terminus of the list, similar to the first item. As discussed above, the gesture need not be exactly vertical to result in vertical scrolling; a gesture within a predefined range of angles from perfectly vertical is sufficient.

In some embodiments, instead of scrolling a list of items in one dimension, a user may desire to translate an electronic document in two dimensions. If the electronic document fills more than the screen area allotted to display the document, the screen will only display a portion of the document. The user may translate the electronic document to view portions of the document that are not initially displayed.

FIG. 7 is a flow diagram illustrating a method 700 of translating an electronic document in accordance with some embodiments. The method 700 provides a simple visual indicator to a user that one or more edges of an electronic document are being displayed.

27

Movement of an object is detected on or near a touch screen display of a device (702). In some embodiments, the object is a finger. In some embodiments, the device is a portable multifunction device.

In response to detecting the movement, an electronic document displayed on the touch screen display is translated in a first direction (704). In some embodiments, the electronic document is a web page, as illustrated in FIGS. 8A-8D. In some embodiments, the electronic document is a digital image. In some embodiments, the electronic document is a word processing, spreadsheet, email, or presentation document. In some embodiments, the first direction is a vertical direction, a horizontal direction, or a diagonal direction. In some embodiments, the first direction corresponds to the direction of movement of the object detected on or near the display but is not necessarily identical to the direction of movement of the object.

In some embodiments, translating the electronic document in the first direction prior to reaching an edge of the electronic document has an associated speed of translation corresponding to a speed of movement of the object (706). In some embodiments, the electronic document is translated in accordance with a simulation of an equation of motion having friction (708).

If an edge of the electronic document is reached (e.g., upon reaching the edge of the document) while translating the electronic document in the first direction while the object is still detected on or near the touch screen display, an area beyond the edge of the electronic document is displayed (710-Yes, 714). In some embodiments, the area beyond the edge of the electronic document is black, gray, a solid color, or white (716). In some embodiments, the area beyond the edge of the electronic document is visually distinct from the document (718). For example, the area 3930 beyond the edge of the web page 3912 in FIG. 8C is black, in contrast to the white background of the web page 3912. In some other embodiments, a wallpaper image such as a picture or pattern may be displayed in the area beyond the edge of the electronic document.

After the object is no longer detected on or near the touch screen display, the electronic document is translated in a second direction until the area beyond the edge of the electronic document is no longer displayed (720). For example, in FIG. 8D the web page 3912 has been translated such that the area 3930 beyond its edge is no longer displayed. In some embodiments, the second direction is opposite the first direction. In some embodiments, the electronic document is translated in the second direction using a damped motion (722). In some embodiments, the change from translating the electronic document in the first direction to translating the electronic document in the second direction until the area beyond the edge of the electronic document is no longer displayed makes the edge of the electronic document appear to be elastically attached to an edge of the touch screen display or to an edge displayed on the touch screen display (724).

In some embodiments, translating in the first direction prior to reaching an edge of the electronic document has a first associated translating distance that corresponds to a distance of movement of the object prior to reaching the edge of the electronic document. For example, a distance of translation of the web page 3912 shown in FIGS. 8A-8D prior to reaching the edge of the document may correspond to a distance traversed on the touch screen display by the swipe gesture 3925 before the edge is reached. In some embodiments, displaying an area beyond the edge of the electronic document includes translating the electronic document in the first direction for a second associated translating distance, wherein the second

28

associated translating distance is less than a distance of movement of the object after reaching the edge of the electronic document. For example, in FIG. 8C, after the edge is reached the web page 3912 is translated by a distance indicated by opposing arrows 3928-1 and 3928-2, which may be less than a distance traversed on the touch screen display by the swipe gesture 3925 after the terminus is reached.

In some embodiments, translating in the first direction prior to reaching an edge of the electronic document has a first associated translating speed that corresponds to a speed of movement of the object. For example, a speed of translation prior to reaching the edge of the web page 3912 shown in FIGS. 8A-8D may correspond to a speed of movement of the swipe gesture 3925. Displaying an area beyond the edge of the electronic document includes translating the electronic document in the first direction at a second associated translating speed. The second associated translating speed is slower than the first associated translating speed. For example, in FIG. 8C, displaying the area 3930 beyond the edge of the web page 3912 may include translating the web page 3912 at a speed that is slower than the speed of translation before the edge is reached. In some embodiments, the second associated speed is a fraction (e.g., one-half or one-third) of the first associated speed. In some embodiments, the second associated speed is the square root of the first associated speed.

If an edge of the electronic document is not reached while translating the electronic document in the first direction while the object is still detected on or near the touch screen display, the process 700 is complete (710-No, 712). The process 700 may be re-initiated upon subsequent detection of another movement of an object on or near the touch screen display (702).

FIGS. 8A-8D illustrate the translation of an electronic document to an edge of the document, at which point an area beyond the edge is displayed and the document is then translated in a second direction until the area beyond the edge of the document is no longer displayed, in accordance with some embodiments. While FIGS. 8A-8D illustrate this translation in the context of a portable multifunction device 100, this translation is not limited to portable multifunction devices. In the example of FIGS. 8A-8D, the document is a web page 3912; FIGS. 8A-8D illustrate an exemplary user interface for a browser in accordance with some embodiments. An analogous user interface may be used to display other types of electronic documents, such as word processing, spreadsheet, email, presentation documents, or digital images.

In some embodiments, user interface 3900A of FIGS. 8A-8D includes the following elements, or a subset or superset thereof:

- 402, 404, and 406, as described above;
- Previous page icon 3902 that when activated (e.g., by a finger tap on the icon) initiates display of the previous web page;
- Web page name 3904;
- Next page icon 3906 that when activated (e.g., by a finger tap on the icon) initiates display of the next web page;
- URL (Uniform Resource Locator) entry box 3908 for inputting URLs of web pages;
- Refresh icon 3910 that when activated (e.g., by a finger tap on the icon) initiates a refresh of the web page;
- Web page 3912 or other structured document, which is made of blocks 3914 of text content and other graphics (e.g., images);
- Settings icon 3916 that when activated (e.g., by a finger tap on the icon) initiates display of a settings menu for the browser;

29

Bookmarks icon **3918** that when activated (e.g., by a finger tap on the icon) initiates display of a bookmarks list or menu for the browser;

Add bookmark icon **3920** that when activated (e.g., by a finger tap on the icon) initiates display of a UI for adding bookmarks; and

New window icon **3922** that when activated (e.g., by a finger tap on the icon) initiates display of a UI for adding new windows to the browser.

In some embodiments, the device analyzes the render tree of the web page **3912** to determine the blocks **3914** in the web page. In some embodiments, a block **3914** corresponds to a render node that is: replaced; a block; an inline block; or an inline table.

In FIG. **8A**, the web page fills more than the allotted screen area: only the left sides of block **7 (3914-7)** and block **8 (3914-8)** are displayed and only the top left corner of block **9 (3914-9)** is displayed. To view the partially displayed blocks, a user may translate the displayed document by gesturing on the touch screen in accordance with some embodiments.

In some embodiments, in response to a substantially vertical upward (or downward) swipe gesture by the user, the web page (or, more generally, other electronic documents) may translate one-dimensionally upward (or downward) in the vertical direction. In some embodiments, a gesture is considered substantially vertical if it is within a predetermined angle of being perfectly vertical. For example, in response to an upward swipe gesture by the user that is within a predetermined angle (e.g.,  $27^\circ$ ) of being perfectly vertical, the web page may scroll one-dimensionally upward in the vertical direction.

Conversely, in some embodiments, in response to a gesture that is not within a predetermined angle (e.g.,  $27^\circ$ ) of being perfectly vertical, the web page may translate two-dimensionally (i.e., with simultaneous movement in both the vertical and horizontal directions). For example, in response to an upward swipe gesture by the user that is not within a predetermined angle (e.g.,  $27^\circ$ ) of being perfectly vertical, the web page may translate two-dimensionally along the direction of the swipe.

In the example of FIG. **8A**, an upward swipe gesture **3925** is not within a predetermined angle of being perfectly vertical. Therefore, as a result of detecting the upward swipe gesture **3925**, the web page is translated in two dimensions. In this example, the translation is approximately diagonal. FIG. **8B** illustrates the result of this translation: blocks **8 (3914-8)** and **9 (3914-9)** are now fully displayed; blocks **1 (3914-1)** and **2 (3914-2)** are now only partially displayed, and block **3 (3914-3)** is no longer displayed at all. This translation is an example of the translation described in operation **704** of process **700** (FIG. **7**).

In FIG. **8B**, block **9 (3914-9)** is in the lower right-hand corner of the web page **3912**; both the bottom and right edges of the web page have been reached while translating the web page. Upon reaching these edges of the document, in response to continued detection of the upward gesture **3925**, an area **3930** (FIG. **8C**) beyond the bottom and right edges of the web page is displayed. In some embodiments, the area displayed beyond the edge(s) of an electronic document is visually distinct from the document, as described in operation **718** of process **700** (FIG. **7**). In FIG. **8C**, the area **3930** is black and thus is visually distinct from the white background of the web page **3912**.

Once the upward gesture **3925** is complete, such that a corresponding object is no longer detected on or near the touch screen display, the web page **3912** is translated (e.g., in a direction opposite to the original direction of translation)

30

until the area **3930** is no longer displayed. FIG. **8D** illustrates the result of this translation, which corresponds to operation **720** of process **700** (FIG. **7**): block **9 (3914-9)** is now displayed in the lower right-hand corner of the portion of the screen allotted to display the web page **3912** and the area **3930** not displayed. In some embodiments, the direction of translation is not necessarily opposite to the original direction but may be in any direction such that, upon completion of the translation, the area beyond the edge(s) of the electronic document is no longer displayed.

FIG. **9** is a flow diagram illustrating a process **900** of displaying an electronic document having a document length and a document width, in accordance with some embodiments. The process **900** provides a simple visual indicator to a user that an electronic document is being displayed at a minimum magnification (e.g., the electronic document cannot be zoomed out and/or demagnified further).

The process **900** is performed at a device with a touch screen display. In some embodiments, the device is a portable multifunction device. In some embodiments, the electronic document is a web page (e.g., web page **3912**, FIGS. **10A-10C**). In some embodiments, the electronic document is a digital image. In some embodiments, the electronic document is a word processing, spreadsheet, email or presentation document.

The electronic document is displayed (**902**) at a first magnification on the touch screen display. A gesture is detected (**904**) on or near the touch screen display corresponding to a command to zoom out by a user-specified amount. In some embodiments, the gesture is a pinching gesture (e.g., gesture **3951/3953**, FIG. **10A**).

In response to detecting the gesture, the electronic document is displayed (**906**) at a magnification less than the first magnification. For example, the web page **3912** is shown at a lesser magnification in FIG. **10B** than in FIG. **10A**.

If the document length or document width is not entirely displayed (**908-Yes**) while the gesture is still detected on or near the touch screen display, the process **900** is complete (**910**).

If, however, the document length (e.g., **3957**, FIG. **10B**) or document width (e.g., **3959**, FIG. **10B**) is entirely displayed (**908-Yes**) while the gesture (e.g., **3951/3953**) is still detected on or near the touch screen display, the electronic document is displayed (**912**) at a magnification wherein areas beyond opposite edges of the electronic document (e.g., areas **3955**, FIG. **10B**) are displayed.

In some embodiments, the areas beyond opposite edges of the electronic document include an area beyond a top edge of the document and an area beyond a bottom edge of the document. In some embodiments, the areas beyond opposite edges of the electronic document include an area beyond a right edge of the document and an area beyond a left edge of the document. In some embodiments, the areas beyond opposite edges of the electronic document include an area beyond a top edge of the document, an area beyond a bottom edge of the document, an area beyond a right edge of the document, and an area beyond a left edge of the document (e.g., FIG. **10B**).

In some embodiments, the areas beyond opposite edges of the electronic document are black, gray, a solid color, or white. In some embodiments, the areas beyond opposite edges of the electronic document are visually distinct from the document. For example, the areas **3955** (FIG. **10B**) are black and thus are visually distinct from the web page **3912**.

Upon detecting termination of the gesture, the electronic document is displayed (**914**) at a magnification wherein the

## 31

areas beyond opposite edges of the electronic document are no longer displayed. For example, the areas 3955 are not displayed in FIG. 10C.

FIGS. 10A-10C illustrate the display of an electronic document at multiple magnifications in accordance with some embodiments. While FIGS. 10A-10C illustrate displaying these multiple magnifications in the context of a portable multifunction device 100, displaying these multiple magnifications is not limited to portable multifunction devices. In the example of FIGS. 10A-10C, the document is a web page 3912; FIGS. 10A-10C (like FIGS. 8A-8D) illustrate an exemplary user interface for a browser in accordance with some embodiments. An analogous user interface may be used to display other types of electronic documents, such as digital images or word processing, spreadsheet, email, or presentation documents.

In FIG. 10A, the web page 3912 is displayed at a first magnification. The web page 3912 fills more than the allotted screen area: only the left sides of block 7 (3914-7) and block 8 (3914-8) are displayed and only the top left corner of block 9 (3914-9) is displayed.

In response to detecting a pinching gesture 3951/3953 (FIG. 10A), the web-page is displayed at a magnification less than the first magnification, as shown in FIG. 10B. If a document length 3957 or a document width 3959 is entirely displayed while the gesture 3951/3953 is still detected, areas 3955 beyond opposite edges of the web page 3912 are displayed. Upon detecting termination of the gesture 3951/3953, the web page 3912 is displayed at a magnification wherein the areas 3955 are no longer displayed, as shown in FIG. 10C.

FIG. 11 is a flow diagram illustrating a process 1100 of displaying an electronic document at multiple magnifications in accordance with some embodiments. The process 1100 provides a simple visual indicator to a user that an electronic document is being displayed at a maximum magnification (e.g., the electronic document cannot be zoomed in and/or magnified further).

The process 1100 is performed at a device with a touch screen display. In some embodiments, the device is a portable multifunction device. In some embodiments, the electronic document is a web page (e.g., web page 3912, FIGS. 12A-12C). In some embodiments, the electronic document is a digital image (e.g., digital image 1302, FIGS. 13A-13C). In some embodiments, the electronic document is a word processing, spreadsheet, email or presentation document.

At least a first portion of the electronic document is displayed (1102) at a first magnification. A gesture is detected (1104) on or near the touch screen display corresponding to a command to zoom in by a user-specified amount. In some embodiments, the gesture is a de-pinching gesture (e.g., 3931/3933, FIGS. 12A and 13A).

In response to detecting the gesture, decreasing portions of the electronic document are displayed (1106) at increasing magnifications. For example, in FIG. 12B a decreased portion of the web page 3912 is displayed at a higher magnification than the portion in FIG. 12A, and in FIG. 13B a decreased portion of the digital image 1302 is displayed at a higher magnification than the portion in FIG. 13A.

If, upon detecting termination of the gesture, the magnification does not exceed a predefined magnification (1108-No), the process 1100 is complete (1110).

If, however, upon detecting termination of the gesture, the magnification exceeds a predefined magnification (1108-Yes), a respective portion of the electronic document is displayed (1112) at the predefined magnification. In the examples of FIGS. 12B and 13B, the magnification exceeds a predefined magnification. Upon detecting termination of the

## 32

gesture 3931/3933, a portion of the web page 3912 is displayed at the predefined magnification, as illustrated in FIG. 12C, and a portion of the digital image 1302 is displayed at the predefined magnification, as illustrated in FIG. 13C.

In some embodiments, immediately prior to detecting termination of the gesture, a last decreased portion of the electronic document is displayed at a first resolution. Upon detecting termination of the gesture, the respective portion of the electronic document is displayed at a second resolution that is greater than the first resolution.

FIGS. 12A-12C illustrate the display of an electronic document at multiple magnifications in accordance with some embodiments. While FIGS. 12A-12C illustrate displaying these multiple magnifications in the context of a portable multifunction device 100, displaying these multiple magnifications is not limited to portable multifunction devices. In the example of FIGS. 12A-12C, the document is a web page 3912; FIGS. 12A-12C (like FIGS. 8A-8D) illustrate an exemplary user interface for a browser in accordance with some embodiments. An analogous user interface may be used to display other types of electronic documents, such as digital images or word processing, spreadsheet, email, or presentation documents.

In FIG. 12A, a first portion of the web page 3912 is displayed at a first magnification. The web page 3912 fills more than the allotted screen area: only the left sides of block 7 (3914-7) and block 8 (3914-8) are displayed and only the top left corner of block 9 (3914-9) is displayed.

In response to detecting a de-pinching gesture 3931/3933 (FIG. 12A), decreasing portions of the web-page 3912 are displayed at increasing magnifications compared to the magnification shown in FIG. 12A. For example, the portion of the web page 3912 shown in FIG. 12B is smaller than and has a higher magnification than the portion of the web page 3912 shown in FIG. 12A.

In the example of FIG. 12B, the magnification exceeds a predefined magnification. Upon detecting termination of the gesture 3931/3933, a portion of the web page 3912 is displayed at the predefined magnification, as illustrated in FIG. 12C.

FIGS. 13A-13C illustrate the display of an electronic document at multiple magnifications in accordance with some embodiments. While FIGS. 13A-13C illustrate displaying these multiple magnifications in the context of a portable multifunction device 100, displaying these multiple magnifications is not limited to portable multifunction devices. In the example of FIGS. 13A-13C, the document is a digital image 1302 that includes an image of a person 1304.

In FIG. 13A, a digital image 1302 is displayed at a first magnification. In response to detecting a de-pinching gesture 3931/3933, decreasing portions of the digital image 1302 are displayed at increasing magnifications compared to the magnification shown in FIG. 13A. For example, the portion of the digital image 1302 shown in FIG. 13B is smaller than and has a higher magnification than the portion of the digital image 1302 shown in FIG. 13A.

In the example of FIG. 13B, the magnification exceeds a predefined magnification. Upon detecting termination of the gesture 3931/3933, a portion of the digital image 1302 is displayed at the predefined magnification, as illustrated in FIG. 13C.

FIG. 14 is a flow diagram illustrating a process 1400 of executing a screen rotation command in accordance with some embodiments. The process 1400 provides a simple visual indicator to a user that the user has not provided a sufficient gesture to initiate a 90° screen rotation command.

The process **1400** is performed at a device with a touch screen display. In some embodiments, the device is a portable multifunction device.

A multifinger twisting gesture (e.g., **1506**, FIG. **15A**, or **1508**, FIG. **15C**) is detected (**1402**) on or near the touch screen display. The multifinger twisting gesture has a corresponding degree of rotation. In some embodiments, the multifinger twisting gesture includes gestures by two thumbs **1604-L** and **1604-R** (FIGS. **16A** and **16D**)

If the corresponding degree of rotation exceeds a predefined degree of rotation (**1404-Yes**), a 90° screen rotation command is executed (**1406**). For example, the digital image **1502** of FIGS. **15A** and **16A** is rotated from a portrait orientation to a landscape orientation, as shown respectively in FIGS. **15B** and **16B**.

If the corresponding degree of rotation does not exceed a predefined degree of rotation (**1404-No**), a screen rotation command with an acute angle of rotation (i.e., less than 90°) is executed (**1408**). For example, the digital image **1502** of FIGS. **15C** and **16D** is rotated by an acute angle, as shown respectively in FIGS. **15D** and **16E**. Upon ceasing to detect the multifinger twisting gesture, a screen rotation command is executed (**1410**) with an angle of rotation opposite to the acute angle (e.g., with the result shown in FIGS. **15E** and **16F**).

FIGS. **15A-15E** illustrate rotating the display of an electronic document or other digital object in accordance with some embodiments. While FIGS. **15A-15E** illustrate display rotation in the context of a portable multifunction device **100**, display rotation is not limited to portable multifunction devices. In the example of FIGS. **15A-15E**, the electronic document is a digital image **1502**.

In FIGS. **15A** and **15C**, the digital image **1502** is displayed in a portrait orientation. A multifinger twisting gesture **1506** (FIG. **15A**) or **1508** (FIG. **15C**) is detected on the touch screen display. The multifinger twisting gesture **1506** or **1508** has a corresponding degree of rotation. In some embodiments, the degree of rotation corresponds to a degree of rotation of an axis between the contact points on the touch screen display of the two fingers in the multifinger gesture (e.g., an axis between the center points or centroids of the contact regions of the two fingers).

In the example of FIG. **15A**, the multifinger twisting gesture **1506** has a corresponding degree of rotation that exceeds a predefined degree of rotation. Thus, a 90° screen rotation command is executed, with the result that the digital image is displayed in a landscape orientation, as shown in FIG. **15B**. In the example of FIG. **15C**, however, the multifinger twisting gesture **1508** has a corresponding degree of rotation that does not exceed a predefined degree of rotation. A screen rotation command with an acute angle of rotation is executed, with the result shown in FIG. **15D**. Upon ceasing to detect the multifinger twisting gesture **1508**, a screen rotation command with an angle opposite to the acute angle is executed, with the result that the portrait orientation of the digital image **1502** is restored, as shown in FIG. **15E**.

FIGS. **16A-16F** illustrate an exemplary screen rotation gesture in accordance with some embodiments. While FIGS. **16A-16F** illustrate this screen rotation gesture in the context of a portable multifunction device **100**, this screen rotation gesture is not limited to portable multifunction devices. In the example of FIGS. **16A-16F**, this screen rotation gesture is used to rotate the digital image **1502**.

In FIG. **16A**, the device **100** displays the digital image **1502** in a portrait orientation. Simultaneous rotation of two thumbs (e.g., **1604-L** and **1604-R**) in a first sense of rotation is detected on the touch screen display **112**. In some embodi-

ments, the first sense of rotation is a clockwise rotation (e.g., FIG. **16C**). The simultaneous rotation of the two thumbs has a corresponding degree of rotation.

In some embodiments, the sense of rotation for each thumb is detected by monitoring the change in orientation of the contact area of the thumb with the touch screen display. For example, if the contact area of the thumb is elliptical, the change in the orientation of an axis of the ellipse may be detected (e.g., from contact ellipse **1606-L** in FIG. **16A** to contact ellipse **1608-L** in FIG. **16B**, as shown on an enlarged portion of touch screen **112** in FIG. **16C**). In some embodiments, the change in the orientation of the axis of the ellipse determines the corresponding degree of rotation. In some embodiments, at least some of a user's other fingers (i.e., fingers other than thumbs **1604-L** and **1604-R**) support the device **100** by contacting the backside of the device.

In some embodiments, the first sense of rotation is a counterclockwise rotation. For example, if thumb **1604-L** is initially on the lower left side of touch screen **112** (rather than the upper left side in FIG. **16A**), thumb **1604-R** is initially on the upper right side of touch screen **112** (rather than the lower right side in FIG. **16A**), and the thumbs are moved apart from each other, then the sense of rotation detected by the touch screen **112** will be counterclockwise for both thumbs.

If the corresponding degree of rotation exceeds a predefined degree of rotation, a 90° screen rotation command is executed. For example, display of the digital image **1502** is rotated from the portrait orientation of FIG. **16A** to a landscape orientation in FIG. **16B**.

If, however, the corresponding degree of rotation does not exceed a predefined degree of rotation, a screen rotation command with an acute angle of rotation is executed. For example, the digital image **1502** in FIG. **16D** is rotated by an acute angle, with the result shown in FIG. **16E**. Once detection of the two thumbs **1604-L** and **1604-R** ceases, a screen rotation command with an angle of rotation opposite to the acute angle is executed, thereby restoring the digital image **1502** to a portrait orientation, as shown in FIG. **16F**.

While FIGS. **6A-6D**, **8A-8D**, **10A-10C**, **12A-12C**, **13A-13C**, **15A-15E**, and **16A-16F** illustrate scrolling, translation, scaling, and rotation operations in the context of a portable multifunction device **100**, similar operations may be performed on any device with a touch-screen display, in accordance with some embodiments. The device, such as device **1700** below, may or may not be portable and the function or functions performed by the device may vary.

FIG. **17** is a block diagram illustrating a device **1700** with a touch-screen display in accordance with some embodiments. Device **1700** need not be portable. The device **1700** typically includes one or more processing units (CPU's) **1710**, one or more network or other communications interfaces **1760**, memory **1770**, and one or more communication buses **1720** for interconnecting these components. The communication buses **1720** may include circuitry (sometimes called a chipset) that interconnects and controls communications between system components. The device **1700** includes a user interface **1730** comprising a touch-screen display **1740**. The user interface **1730** also may include a keyboard and/or mouse (or other pointing device) **1750**. Memory **1770** includes high-speed random access memory, such as DRAM, SRAM, DDR RAM or other random access solid state memory devices; and may include non-volatile memory, such as one or more magnetic disk storage devices, optical disk storage devices, flash memory devices, or other non-volatile solid state storage devices. Memory **1770** may optionally include one or more storage devices remotely located from the CPU(s) **1710**. In some embodiments, memory **1770** stores

US 7,469,381 B2

35

programs, modules, and data structures analogous to the programs, modules, and data structures stored in the memory 102 of portable multifunction device 100 (FIG. 1), or a subset thereof. Furthermore, memory 1770 may store additional programs, modules, and data structures (not shown) not present in the memory 102 of portable multifunction device 100.

Each of the above identified elements in FIG. 17 may be stored in one or more of the previously mentioned memory devices. Each of the above identified modules corresponds to a set of instructions for performing a function described above. The above identified modules or programs (i.e., sets of instructions) need not be implemented as separate software programs, procedures or modules, and thus various subsets of these modules may be combined or otherwise re-arranged in various embodiments. In some embodiments, memory 1770 may store a subset of the modules and data structures identified above. Furthermore, memory 1770 may store additional modules and data structures not described above.

The foregoing description, for purpose of explanation, has been described with reference to specific embodiments. However, the illustrative discussions above are not intended to be exhaustive or to limit the invention to the precise forms disclosed. Many modifications and variations are possible in view of the above teachings. The embodiments were chosen and described in order to best explain the principles of the invention and its practical applications, to thereby enable others skilled in the art to best utilize the invention and various embodiments with various modifications as are suited to the particular use contemplated.

What is claimed is:

1. A computer-implemented method, comprising:
  - at a device with a touch screen display:
    - displaying a first portion of an electronic document;
    - detecting a movement of an object on or near the touch screen display;
    - in response to detecting the movement, translating the electronic document displayed on the touch screen display in a first direction to display a second portion of the electronic document, wherein the second portion is different from the first portion;
    - in response to an edge of the electronic document being reached while translating the electronic document in the first direction while the object is still detected on or near the touch screen display:
      - displaying an area beyond the edge of the document, and
      - displaying a third portion of the electronic document, wherein the third portion is smaller than the first portion; and
    - in response to detecting that the object is no longer on or near the touch screen display, translating the electronic document in a second direction until the area beyond the edge of the electronic document is no longer displayed to display a fourth portion of the electronic document, wherein the fourth portion is different from the first portion.
2. The computer-implemented method of claim 1, wherein the first portion of the electronic document, the second portion of the electronic document, the third portion of the electronic document, and the fourth portion of the electronic document are displayed at the same magnification.
3. The computer-implemented method of claim 1, wherein the movement of the object is on the touch screen display.
4. The computer-implemented method of claim 1, wherein the object is a finger.

36

5. The computer-implemented method of claim 1, wherein the first direction is a vertical direction, a horizontal direction, or a diagonal direction.

6. The computer-implemented method of claim 1, wherein the electronic document is a web page.

7. The computer-implemented method of claim 1, wherein the electronic document is a digital image.

8. The computer-implemented method of claim 1, wherein the electronic document is a word processing, spreadsheet, email or presentation document.

9. The computer-implemented method of claim 1, wherein the electronic document includes a list of items.

10. The computer-implemented method of claim 1, wherein the second direction is opposite the first direction.

11. The computer-implemented method of claim 1, wherein translating in the first direction prior to reaching an edge of the document has an associated speed of translation that corresponds to a speed of movement of the object.

12. The computer-implemented method of claim 1, wherein translating in the first direction is in accordance with a simulation of an equation of motion having friction.

13. The computer-implemented method of claim 1, wherein the area beyond the edge of the document is black, gray, a solid color, or white.

14. The computer-implemented method of claim 1, wherein the area beyond the edge of the document is visually distinct from the document.

15. The computer-implemented method of claim 1, wherein translating the document in the second direction is a damped motion.

16. The computer-implemented method of claim 1, wherein changing from translating in the first direction to translating in the second direction until the area beyond the edge of the document is no longer displayed makes the edge of the electronic document appear to be elastically attached to an edge of the touch screen display or to an edge displayed on the touch screen display.

17. The computer-implemented method of claim 1, wherein translating in the first direction prior to reaching the edge of the electronic document has a first associated translating distance that corresponds to a distance of movement of the object prior to reaching the edge of the electronic document; and wherein displaying an area beyond the edge of the electronic document comprises translating the electronic document in the first direction for a second associated translating distance, wherein the second associated translating distance is less than a distance of movement of the object after reaching the edge of the electronic document.

18. The computer-implemented method of claim 1, wherein translating in the first direction prior to reaching the edge of the electronic document has a first associated translating speed that corresponds to a speed of movement of the object, and wherein displaying an area beyond the edge of the electronic document comprises translating the electronic document in the first direction at a second associated translating speed, wherein the second associated translating speed is slower than the first associated translating speed.

19. A device, comprising:
 

- a touch screen display;
- one or more processors;
- memory; and
- one or more programs, wherein the one or more programs are stored in the memory and configured to be executed by the one or more processors, the programs including:
  - instructions for displaying a first portion of an electronic document;



US 7,469,381 B2

37

instructions for detecting a movement of an object on or near the touch screen display;

instructions for translating the electronic document displayed on the touch screen display in a first direction to display a second portion of the electronic document, wherein the second portion is different from the first portion, in response to detecting the movement;

instructions for displaying an area beyond an edge of the electronic document and displaying a third portion of the electronic document, wherein the third portion is smaller than the first portion, in response to the edge of the electronic document being reached while translating the electronic document in the first direction while the object is still detected on or near the touch screen display; and

instructions for translating the electronic document in a second direction until the area beyond the edge of the electronic document is no longer displayed to display a fourth portion of the electronic document, wherein the fourth portion is different from the first portion, in response to detecting that the object is no longer on or near the touch screen display.

20. A computer readable storage medium having stored therein instructions, which when executed by a device with a touch screen display, cause the device to:

38

display a first portion of an electronic document;

detect a movement of an object on or near the touch screen display;

translate the electronic document displayed on the touch screen display in a first direction to display a second portion of the electronic document, wherein the second portion is different from the first portion, in response to detecting the movement

display an area beyond an edge of the electronic document and display a third portion of the electronic document, wherein the third portion is smaller than the first portion, if the edge of the electronic document is reached while translating the electronic document in the first direction while the object is still detected on or near the touch screen display; and

translate the electronic document in a second direction until the area beyond the edge of the electronic document is no longer displayed to display a fourth portion of the electronic document, wherein the fourth portion is different from the first portion, in response to detecting that the object is no longer on or near the touch screen display.

\* \* \* \* \*

UNITED STATES PATENT AND TRADEMARK OFFICE  
**CERTIFICATE OF CORRECTION**

PATENT NO. : 7,469,381 B2  
APPLICATION NO. : 11/956969  
DATED : December 23, 2008  
INVENTOR(S) : Ording

Page 1 of 1

It is certified that error appears in the above-identified patent and that said Letters Patent is hereby corrected as shown below:

Column 38, line 8, please insert -- ; -- after movement.

Signed and Sealed this

Seventeenth Day of February, 2009

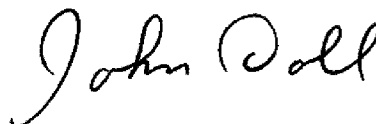
A handwritten signature in black ink that reads "John Doll". The signature is written in a cursive style with a large initial "J" and a long, sweeping underline.

JOHN DOLL  
*Acting Director of the United States Patent and Trademark Office*



US007469381C1

(12) **EX PARTE REEXAMINATION CERTIFICATE** (8187th)  
**United States Patent**  
**Ording**

(10) **Number:** **US 7,469,381 C1**  
 (45) **Certificate Issued:** **Apr. 26, 2011**

(54) **LIST SCROLLING AND DOCUMENT TRANSLATION, SCALING, AND ROTATION ON A TOUCH-SCREEN DISPLAY**

(75) **Inventor:** **Bas Ording**, San Francisco, CA (US)

(73) **Assignee:** **Apple Inc.**, Cupertino, CA (US)

**Reexamination Request:**  
 No. 90/010,963, Apr. 28, 2010

**Reexamination Certificate for:**  
 Patent No.: **7,469,381**  
 Issued: **Dec. 23, 2008**  
 Appl. No.: **11/956,969**  
 Filed: **Dec. 14, 2007**

Certificate of Correction issued Feb. 17, 2009.

**Related U.S. Application Data**

(60) Provisional application No. 60/879,253, filed on Jan. 7, 2007, provisional application No. 60/883,801, filed on Jan. 7, 2007, provisional application No. 60/879,469, filed on Jan. 8, 2007, provisional application No. 60/945,858, filed on Jun. 22, 2007, provisional application No. 60/946,971, filed on Jun. 28, 2007, and provisional application No. 60/937,993, filed on Jun. 29, 2007.

(51) **Int. Cl.**  
**G06F 3/01** (2006.01)  
**G06F 3/048** (2006.01)  
**G06F 3/033** (2006.01)  
**G06F 3/14** (2006.01)

(52) **U.S. Cl.** ..... **715/702; 715/764; 715/769; 715/863; 715/864**

(58) **Field of Classification Search** ..... **715/702**  
 See application file for complete search history.

(56) **References Cited**

**U.S. PATENT DOCUMENTS**

5,463,725 A 10/1995 Henckel et al. .... 395/155  
 6,690,387 B2 2/2004 Zimmerman et al.  
 2005/0195154 A1 9/2005 Robbins et al.

**FOREIGN PATENT DOCUMENTS**

AU 2007283771 A1 4/2008  
 CN 1695105 A 11/2005  
 JP 02140822 5/1990  
 JP 03271976 12/1991

**OTHER PUBLICATIONS**

Forlines et al., Glimpse: A Novel Input Model for Multi-Level Devices, Apr. 2005, 6 pages total, Mitsubishi Electric Research Laboratories, Cambridge, MA (Exhibit B).  
 Millhollon et al., Microsoft Office Word 2003 Inside Out, 2003, Microsoft Press, Redmond, Washington, pp. 93, 762-765. (Exhibit C).

*Primary Examiner*—Rachna S Desai

(57) **ABSTRACT**

In accordance with some embodiments, a computer-implemented method for use in conjunction with a device with a touch screen display is disclosed. In the method, a movement of an object on or near the touch screen display is detected. In response to detecting the movement, an electronic document displayed on the touch screen display is translated in a first direction. If an edge of the electronic document is reached while translating the electronic document in the first direction while the object is still detected on or near the touch screen display, an area beyond the edge of the document is displayed. After the object is no longer detected on or near the touch screen display, the document is translated in a second direction until the area beyond the edge of the document is no longer displayed.

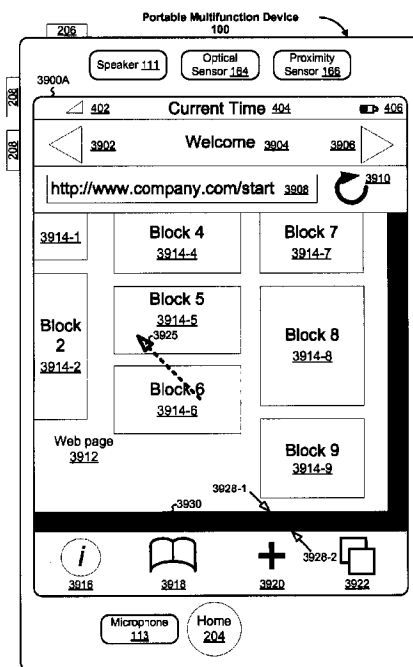

US 7,469,381 C1

**1**  
**EX PARTE**  
**REEXAMINATION CERTIFICATE**  
**ISSUED UNDER 35 U.S.C. 307**

NO AMENDMENTS HAVE BEEN MADE TO  
THE PATENT

**2**  
AS A RESULT OF REEXAMINATION, IT HAS BEEN  
DETERMINED THAT:

5 The patentability of claims 1-20 is confirmed.

\* \* \* \* \*



UNITED STATES PATENT AND TRADEMARK OFFICE

UNITED STATES DEPARTMENT OF COMMERCE  
 United States Patent and Trademark Office  
 Address: COMMISSIONER FOR PATENTS  
 P.O. Box 1450  
 Alexandria, Virginia 22313-1450  
 www.uspto.gov



Bib Data Sheet

CONFIRMATION NO. 4807

<b>SERIAL NUMBER</b> 90/012,304	<b>FILING OR 371(c) DATE</b> 05/23/2012 <b>RULE</b>	<b>CLASS</b> 715	<b>GROUP ART UNIT</b> 3992	<b>ATTORNEY DOCKET NO.</b> 0331834.381
------------------------------------	---	---------------------	-------------------------------	---

**APPLICANTS**  
 7,469,381, Residence Not Provided;  
 APPLE INC. (OWNER), CUPERTINO, CA;  
 JOSEPH J. RICETTI (3RD PTY. REQ.), NEW YORK, NY;  
 BRYAN CAVE LLP, NEW YORK, NY

**\*\* CONTINUING DATA \*\*\*\*\***  
 This application is a REX of 11/956,969 12/14/2007 PAT 7469381  
 which claims benefit of 60/879,253 01/07/2007  
 and claims benefit of 60/883,801 01/07/2007  
 and claims benefit of 60/879,469 01/08/2007  
 and claims benefit of 60/945,858 06/22/2007  
 and claims benefit of 60/946,971 06/28/2007  
 and claims benefit of 60/937,993 06/29/2007

**\*\* FOREIGN APPLICATIONS \*\*\*\*\***

Foreign Priority claimed <input type="checkbox"/> yes <input type="checkbox"/> no	<b>STATE OR COUNTRY</b>	<b>SHEETS DRAWING</b>	<b>TOTAL CLAIMS</b> 20	<b>INDEPENDENT CLAIMS</b> 3
35 USC 119 (a-d) conditions met <input type="checkbox"/> yes <input type="checkbox"/> no <input type="checkbox"/> Met after Allowance				
Verified and Acknowledged	Examiner's Signature	Initials		

**ADDRESS**  
 61725

**TITLE**  
 LIST SCROLLING AND DOCUMENT TRANSLATION, SCALING, AND ROTATION ON A TOUCH-SCREEN DISPLAY

<b>FILING FEE RECEIVED</b> 2520	FEES: Authority has been given in Paper No. _____ to charge/credit DEPOSIT ACCOUNT No. _____ for following:	<input type="checkbox"/> All Fees <input type="checkbox"/> 1.16 Fees ( Filing ) <input type="checkbox"/> 1.17 Fees ( Processing Ext. of time ) <input type="checkbox"/> 1.18 Fees ( Issue ) <input type="checkbox"/> Other _____ <input type="checkbox"/> Credit
------------------------------------	---	---

## Patent Assignment Abstract of Title

**Total Assignments: 1**

Application #: 11956969

Filing Dt: 12/14/2007

Patent #: 7469381

Issue Dt: 12/23/2008

PCT #: NONE

Publication #: US20080168404

Pub Dt: 07/10/2008

Inventor: Bas Ording

Title: LIST SCROLLING AND DOCUMENT TRANSLATION, SCALING, AND ROTATION ON A TOUCH-SCREEN DISPLAY

**Assignment: 1**

Reel/Frame: 021397 / 0743

Received: 08/15/2008

Recorded: 08/15/2008

Mailed: 08/18/2008

Pages: 2

Conveyance: ASSIGNMENT OF ASSIGNORS INTEREST (SEE DOCUMENT FOR DETAILS).

Assignor: ORDING, BAS

Exec Dt: 12/07/2007

Assignee: APPLE INC.

1 INFINITE LOOP

CUPERTINO, CALIFORNIA 95014

Correspondent: GARY S. WILLIAMS

MORGAN, LEWIS & BOCKIUS LLP

3000 EL CAMINO REAL, BLDG. 2, SUITE 700

PALO ALTO, CA 94306

Search Results as of: 06/07/2012 09:07 AM

**UNITED STATES PATENT AND TRADEMARK OFFICE**

UNITED STATES DEPARTMENT OF COMMERCE  
**United States Patent and Trademark Office**  
 Address: COMMISSIONER FOR PATENTS  
 P.O. Box 1450  
 Alexandria, Virginia 22313-1450  
 www.uspto.gov

REEXAM CONTROL NUMBER	FILING OR 371 (c) DATE	PATENT NUMBER
90/012,304	05/23/2012	7469381

**CONFIRMATION NO. 4807**  
**REEXAM ASSIGNMENT NOTICE**

61725  
 Morgan Lewis & Bockius LLP/ AI  
 2 Palo Alto Square  
 3000 El Camino Real, Suite 700  
 Palo Alto, CA 94306



Date Mailed: 06/08/2012

**NOTICE OF ASSIGNMENT OF REEXAMINATION REQUEST**

The above-identified request for reexamination has been assigned to Art Unit 3992. All future correspondence to the proceeding should be identified by the control number listed above and directed to the assigned Art Unit.

A copy of this Notice is being sent to the latest attorney or agent of record in the patent file or to all owners of record. (See 37 CFR 1.33(c)). If the addressee is not, or does not represent, the current owner, he or she is required to forward all communications regarding this proceeding to the current owner(s). An attorney or agent receiving this communication who does not represent the current owner(s) may wish to seek to withdraw pursuant to 37 CFR 1.36 in order to avoid receiving future communications. If the address of the current owner(s) is unknown, this communication should be returned within the request to withdraw pursuant to Section 1.36.

cc: Third Party Requester(if any)  
 BRYAN CAVE LLP  
 1290 AVENUE OF THE AMERICAS  
 NEW YORK, NY 10104

/jawhitfield/

---

Legal Instruments Examiner  
 Central Reexamination Unit 571-272-7705; FAX No. 571-273-9900

**UNITED STATES PATENT AND TRADEMARK OFFICE**

UNITED STATES DEPARTMENT OF COMMERCE  
**United States Patent and Trademark Office**  
 Address: COMMISSIONER FOR PATENTS  
 P.O. Box 1450  
 Alexandria, Virginia 22313-1450  
 www.uspto.gov

REEXAM CONTROL NUMBER	FILING OR 371 (c) DATE	PATENT NUMBER
90/012,304	05/23/2012	7469381

BRYAN CAVE LLP  
 1290 AVENUE OF THE AMERICAS  
 NEW YORK, NY 10104

**CONFIRMATION NO. 4807**  
**REEXAMINATION REQUEST**  
**NOTICE**



Date Mailed: 06/08/2012

**NOTICE OF REEXAMINATION REQUEST FILING DATE**

*(Third Party Requester)*

Requester is hereby notified that the filing date of the request for reexamination is 05/23/2012, the date that the filing requirements of 37 CFR § 1.510 were received.

A decision on the request for reexamination will be mailed within three months from the filing date of the request for reexamination. (See 37 CFR 1.515(a)).

A copy of the Notice is being sent to the person identified by the requester as the patent owner. Further patent owner correspondence will be the latest attorney or agent of record in the patent file. (See 37 CFR 1.33). Any paper filed should include a reference to the present request for reexamination (by Reexamination Control Number).

cc: Patent Owner  
 61725  
 Morgan Lewis & Bockius LLP/ AI  
 2 Palo Alto Square  
 3000 El Camino Real, Suite 700  
 Palo Alto, CA 94306

/jawhitfield/

---

Legal Instruments Examiner  
 Central Reexamination Unit 571-272-7705; FAX No. 571-273-9900



# Litigation Search Report CRU 3999

Reexam Control No. 90/012,304

**To: Examiner**  
**Art Unit: 3992**  
**Date: 06/14/12**

**Case Serial Number: 90/012,304**

**From: Karen L. Ward**  
**Location: CRU 3999**  
**MDW 7C76**  
**Phone: (571) 272-7932**  
**Karen.Ward@uspto.gov**

## Search Notes

Litigation was found involving U.S. Patent No. 7,469,381.

5:11CV1846 – OPEN  
1:10CV167 – OPEN

- 1) I performed a KeyCite Search in Westlaw, which retrieves all history on the patent including any litigation.
- 2) I performed a search on the patent in Lexis CourtLink for any open dockets or closed cases.
- 3) I performed a search in Lexis in the Federal Courts and Administrative Materials databases for any cases found.
- 4) I performed a search in Lexis in the IP Journal and Periodicals database for any articles on the patent.
- 5) I performed a search in Lexis in the news databases for any articles about the patent or any articles about litigation on this patent.



Date of Printing: Jun 14, 2012

**KEYCITE**

**H US PAT 7469381 LIST SCROLLING AND DOCUMENT TRANSLATION, SCALING, AND ROTATION ON A TOUCH-SCREEN DISPLAY, Assignee: Apple Inc. (Dec 23, 2008)**

**History**

**Direct History**

- H** 1 METHOD AND APPARATUS FOR DISPLAYING AND ACCESSING CONTROL AND STATUS INFORMATION IN A COMPUTER SYSTEM, US PAT 6493002, 2002 WL 31763393 (U.S. PTO Utility Dec 10, 2002)  
*Construed by*
- H** 2 Apple, Inc. v. Samsung Electronics Co., Ltd., 2012 WL 1123752, 2012 Markman 1123752 (N.D.Cal. Apr 04, 2012) (NO. 11-CV-01846-LHK) (Markman Order Version)
- => 3 **LIST SCROLLING AND DOCUMENT TRANSLATION, SCALING, AND ROTATION ON A TOUCH-SCREEN DISPLAY, US PAT 7469381, 2008 WL 5338648 (U.S. PTO Utility Dec 23, 2008)**  
*Construed by*
- H** 4 Apple, Inc. v. Samsung Electronics Co., Ltd., 2012 WL 1123752, 2012 Markman 1123752 (N.D.Cal. Apr 04, 2012) (NO. 11-CV-01846-LHK) (Markman Order Version)
- H** 5 MULTIPOINT TOUCHSCREEN, US PAT 7663607, 2010 WL 524359 (U.S. PTO Utility Feb 16, 2010)  
*Construed by*
- H** 6 Apple, Inc. v. Samsung Electronics Co., Ltd., 2012 WL 1123752, 2012 Markman 1123752 (N.D.Cal. Apr 04, 2012) (NO. 11-CV-01846-LHK) (Markman Order Version)
- H** 7 MULTI-TASKING APPARATUS AND METHOD IN PORTABLE TERMINAL, US PAT 7698711, 2010 WL 1447873 (U.S. PTO Utility Apr 13, 2010)  
*Construed by*
- H** 8 Apple, Inc. v. Samsung Electronics Co., Ltd., 2012 WL 1123752, 2012 Markman 1123752 (N.D.Cal. Apr 04, 2012) (NO. 11-CV-01846-LHK) (Markman Order Version)
- H** 9 ELLIPSE FITTING FOR MULTI-TOUCH SURFACES, US PAT 7812828, 2010 WL 4004510 (U.S. PTO Utility Oct 12, 2010)  
*Construed by*

© 2012 Thomson Reuters. All rights reserved.

- H** 10 Apple, Inc. v. Samsung Electronics Co., Ltd., 2012 WL 1123752, 2012 Markman 1123752 (N.D.Cal. Apr 04, 2012) (NO. 11-CV-01846-LHK) (Markman Order Version)
- H** 11 APPLICATION PROGRAMMING INTERFACES FOR SCROLLING OPERATIONS, US PAT 7844915, 2010 WL 4843993 (U.S. PTO Utility Nov 30, 2010)  
*Construed by*
- H** 12 Apple, Inc. v. Samsung Electronics Co., Ltd., 2012 WL 1123752, 2012 Markman 1123752 (N.D.Cal. Apr 04, 2012) (NO. 11-CV-01846-LHK) (Markman Order Version)
- H** 13 METHOD AND APPARATUS FOR DISPLAYING A WINDOW FOR A USER INTERFACE, US PAT 7853891, 2010 WL 5073908 (U.S. PTO Utility Dec 14, 2010)  
*Construed by*
- H** 14 Apple, Inc. v. Samsung Electronics Co., Ltd., 2012 WL 1123752, 2012 Markman 1123752 (N.D.Cal. Apr 04, 2012) (NO. 11-CV-01846-LHK) (Markman Order Version)

**Related References**

- H** 15 Apple Inc. v. Samsung Electronics Co., Ltd., 2011 WL 1938154 (N.D.Cal. May 18, 2011) (NO. 11-CV-01846-LHK)
- H** 16 Apple Inc. v. Samsung Electronics Co., Ltd., 768 F.Supp.2d 1040, 79 Fed.R.Serv.3d 1178 (N.D.Cal. Jun 21, 2011) (NO. 11-CV-01846-LHK)
- H** 17 Apple Inc. v. Samsung Electronics Co., Ltd., 2011 WL 4948567, 2011-2 Trade Cases P 77,648, 101 U.S.P.Q.2d 1125 (N.D.Cal. Oct 18, 2011) (NO. 11-CV-01846-LHK) (BNA Version)
- V** 18 Apple, Inc. v. Samsung Electronics Co., Ltd., 2011 WL 7036077 (N.D.Cal. Dec 02, 2011) (NO. 11-CV-01846-LHK)  
*Affirmed in Part, Vacated in Part, Remanded by*
- H** 19 Apple, Inc. v. Samsung Electronics Co., Ltd., --- F.3d ---, 2012 WL 1662048, 102 U.S.P.Q.2d 1633 (Fed.Cir.(Cal.) May 14, 2012) (NO. 2012-1105) (BNA Version)
- H** 20 Apple Inc. v. Samsung Electronics Co., Ltd., 2012 WL 1511901 (N.D.Cal. Jan 27, 2012) (NO. C 11-1846 LHK PSG)
- H** 21 Apple, Inc. v. Samsung Electronics Co., Ltd., 2012 WL 694745 (N.D.Cal. Mar 01, 2012) (NO. 11-CV-01846-LHK)
- H** 22 Apple Inc. v. Samsung Electronics Co., Ltd., 2012 WL 762240 (N.D.Cal. Mar 08, 2012) (NO. C 11-CV-1846 LHK PSG)
- H** 23 Apple Inc. v. Samsung Electronics Co., Ltd., 2012 WL 952254 (N.D.Cal. Mar 20, 2012) (NO. C 11-CV-1846 LHK PSG)
- H** 24 Apple, Inc. v. Samsung Electronics Co., Ltd., 2012 WL 1067548 (N.D.Cal. Mar 27, 2012) (NO. 11-CV-01846-LHK)

- H** 25 Apple Inc. v. Samsung Electronics Co., Ltd, 2012 WL 1144060 (N.D.Cal. Apr 04, 2012) (NO. C 11-CV-1846 LHK)
- H** 26 Apple Inc. v. Samsung Electronics Co., Ltd., 2012 WL 1232267 (N.D.Cal. Apr 12, 2012) (NO. C 11-1846 LHK PSG)
- H** 27 Apple Inc. v. Samsung Electronics Co., Ltd., 2012 WL 1413385 (N.D.Cal. Apr 23, 2012) (NO. C 11-1846 LHK PSG)
- H** 28 Apple Inc. v. Samsung Electronics Co., Ltd., 2012 WL 1595784 (N.D.Cal. May 04, 2012) (NO. C 11-1846 LHK PSG)
- H** 29 Apple Inc. v. Samsung Electronics Co., Ltd., 2012 WL 1672493 (N.D.Cal. May 14, 2012) (NO. 11-CV-01846)
- H** 30 Apple, Inc. v. Samsung Electronics Co., Ltd., 2012 WL 1987042 (N.D.Cal. Jun 04, 2012) (NO. 11-CV-01846-LHK)

#### Court Documents

#### Trial Court Documents (U.S.A.)

#### N.D.Cal. Trial Pleadings

- 31 APPLE INC., a California corporation, Plaintiff, v. SAMSUNG ELECTRONICS CO., LTD., a Korean corporation; Samsung Electronics America, Inc., a New York corporation; Samsung Telecommunications America, LLC, a Delaware limited liability company, Defendants., 2011 WL 1461508 (Trial Pleading) (N.D.Cal. Apr. 15, 2011) **Complaint for Patent Infringement, Federal False Designation of Origin and Unfair Competition, Federal Trademark Infringement, State Unfair Competition, Common Law Trademark Infringement, and Unjust E** (NO. CV111846LB)
- 32 APPLE INC., a California corporation, Plaintiff, v. SAMSUNG ELECTRONICS CO., LTD., a Korean corporation; Samsung Electronics America, Inc., a New York corporation; Samsung Telecommunications America, LLC, a Delaware limited liability company. Defendants., 2011 WL 1523876 (Trial Pleading) (N.D.Cal. Apr. 15, 2011) **Complaint for Patent Infringement, Federal False Designation of Origin and Unfair Competition, Federal Trademark Infringement, State Unfair Competition, Common Law Trademark Infringement, and Unjust E** (NO. CV111846)
- 33 APPLE INC., a California corporation, Plaintiff, v. SAMSUNG ELECTRONICS CO., LTD., a Korean corporation; Samsung Electronics America, Inc., a New York corporation; and Samsung Telecommunications America, LLC, a Delaware limited liability company, Defendants., 2011 WL 2422278 (Trial Pleading) (N.D.Cal. Jun. 16, 2011) **Amended Complaint for Federal False Designation of Origin and Unfair Competition, Federal Trademark Infringement, Federal Trade Dress Dilution, State Unfair Business Practices, Common Law Trademark In** (NO. 11-CV-01846-LHK)
- 34 APPLE INC., a California corporation, Plaintiff, v. SAMSUNG ELECTRONICS CO., Ltd., a Korean corporation; Samsung Electronics America, Inc., a New York corporation; and Samsung Telecommunications America, LLC, a Delaware limited liability company, Defendants., 2011 WL 2582932 (Trial Pleading) (N.D.Cal. Jun. 16, 2011) **Amended Complaint for Federal False**

- Designation of Origin and Unfair Competition, Federal Trademark Infringement, Federal Trade Dress Dilution, State Unfair Business Practices, Common Law Trademark In** (NO. 11-CV-01846-LHK)
- 35 APPLE INC., a California corporation, Plaintiff, v. SAMSUNG ELECTRONICS CO., LTD., a Korean business entity; Samsung Electronics America, Inc., a New York corporation; Samsung Telecommunications America, LLC, a Delaware limited liability company, Defendants., 2011 WL 2731786 (Trial Pleading) (N.D.Cal. Jun. 30, 2011) **Samsung Entities' Answer, Affirmative Defenses, and Counterclaims to Apple Inc.'s Amended Complaint; and** (NO. 11-CV-01846-LHK)
- 36 APPLE INC., a California corporation, Plaintiffs, v. SAMSUNG ELECTRONICS CO., Ltd., a Korean business entity, Samsung Electronics America, Inc., a New York corporation, and Samsung Telecommunications America, LLC, a Delaware limited liability company, Defendants; Samsung Electronics Co., Ltd., a Kor, 2011 WL 3205801 (Trial Pleading) (N.D.Cal. Jul. 21, 2011) **Counterclaim Defendant Apple Inc.'s Answer, Defenses, and Counterclaims in Reply to Samsung's Counterclaims** (NO. 11-CV-01846-LHK)
- 37 APPLE INC., a California corporation, Plaintiffs, v. SAMSUNG ELECTRONICS CO., LTD., a Korean business entity, Samsung Electronics America, Inc., a new York corporation, and Samsung Telecommunications America, LLC, a Delaware limited liability company, Defendants; Samsung Electronics Co., Ltd., a Kor, 2011 WL 5595844 (Trial Pleading) (N.D.Cal. Nov. 8, 2011) **Counterclaim Defendant Apple Inc.'s Amended Answer, Defenses, and Counterclaims in Reply to Samsung's Counterclaims** (NO. 11-CV-01846-LHK)

#### **N.D.Cal. Expert Testimony**

- 38 APPLE INC., a California corporation, Plaintiff, v. SAMSUNG ELECTRONICS CO., LTD., A Korean business entity; Samsung Electronics America, Inc., a New York corporation; Samsung Telecommunications America, LLC, a Delaware limited liability company, Defendants., 2011 WL 7464353 (Expert Report and Affidavit) (N.D.Cal. Jun. 30, 2011) **Declaration of Cooper C. Woodring In Support of Apple's Motion for A Preliminary Injunction** (NO. 11-CV-01846-LHK)
- 39 APPLE INC., a California corporation, Plaintiff, v. SAMSUNG ELECTRONICS CO., LTD., A Korean business entity; Samsung Electronics America, Inc., a new York corporation; Samsung Telecommunications America, LLC, a Delaware limited liability company, Defendants., 2011 WL 7464354 (Expert Report and Affidavit) (N.D.Cal. Jun. 30, 2011) **Declaration of Ravin Balakrishnan, Ph.D. In Support of Apple's Motion for a preliminary Injunction** (NO. 11-CV-01846-LHK)
- 40 APPLE INC., a California corporation, Plaintiff, v. SAMSUNG ELECTRONICS CO., LTD., a Korean business entity; Samsung Electronics America, Inc., a New York corporation; Samsung Telecommunications America, LLC, a Delaware limited liability company, Defendants., 2011 WL 3754046 (Expert Report and Affidavit) (N.D.Cal. Aug. 20, 2011) **Declaration of Andries Van Dam, Ph.D. In Support of Samsung's Opposition to Apple's Motion for A preliminary Injunction** (NO. 11-CV-01846-LHK)
- 41 APPLE INC., a California corporation, Plaintiff, v. SAMSUNG ELECTRONICS CO., LTD., a Korean business entity; Samsung Electronics America, Inc., a New York corporation; Samsung

- Telecommunications America, LLC, a Delaware limited liability company, Defendants., 2011 WL 3754045 (Expert Report and Affidavit) (N.D.Cal. Aug. 22, 2011) **Declaration of Nicholas P. Godici In Support of Samsung's Opposition to Apple's Motion for A preliminary Injunction** (NO. 11-CV-01846-LHK)
- 42 APPLE INC., a California corporation, Plaintiff, v. SAMSUNG ELECTRONICS CO., LTD., a Korean business entity; Samsung Electronics America, Inc., a New York corporation; Samsung Telecommunications America, LLC, a Delaware limited liability company, Defendants., 2011 WL 3754047 (Expert Report and Affidavit) (N.D.Cal. Aug. 22, 2011) **Declaration of Itay Sherman in Support of Samsung's Opposition to Apple's Motion for a Preliminary Injunction** (NO. 11-CV-01846-LHK)
- 43 APPLE INC., a California corporation, Plaintiff, v. SAMSUNG ELECTRONICS CO., Ltd., a Korean business entity; Samsung Electronics America, Inc., a New York corporation; Samsung Telecommunications America, LLC, a Delaware limited liability company, Defendants., 2011 WL 6257997 (Expert Report and Affidavit) (N.D.Cal. Aug. 22, 2011) **Declaration of Jeffrey Johnson, Ph.D., in Support of Samsung's Opposition to Apple's Motion for A Preliminary Injunction** (NO. 11-CV-01846-LHK)
- 44 APPLE INC., a California corporation, Plaintiff, v. SAMSUNG ELECTRONICS CO., LTD., A Korean business entity; SAMSUNG Electronics America, Inc., a New York corporation; Samsung Telecommunications America, LLC, a Delaware limited liability company, Defendants., 2011 WL 7464345 (Expert Report and Affidavit) (N.D.Cal. Sep. 29, 2011) **Reply Declaration of Ravin Balakrishnan, Ph.D. in Support of Apple's Motion for A preliminary Injunction** (NO. 11-CV-01846-LHK)
- 45 APPLE INC., a California corporation, Plaintiff, v. SAMSUNG ELECTRONICS CO., LTD., A Korean business entity; Samsung Electronics America, Inc., a New York corporation; Samsung Telecommunications America, LLC, a Delaware limited liability company, Defendants., 2011 WL 7464346 (Expert Report and Affidavit) (N.D.Cal. Sep. 30, 2011) **Reply Declaration of Peter W. Bressler in Support of Apple's Motion for A preliminary Injunction** (NO. 11-CV-01846-LHK)
- 46 APPLE INC., a California corporation, Plaintiff, v. SAMSUNG ELECTRONICS CO., LTD., A Korean business entity; Samsung Electronics America, Inc., a New York corporation; Samsung Telecommunications America, LLC, a Delaware limited liability company, Defendants., 2011 WL 7464347 (Expert Report and Affidavit) (N.D.Cal. Sep. 30, 2011) **Reply Declaration of Cooper C. Woodring in Support of Apple's Motion for A preliminary Injunction** (NO. 11-CV-01846-LHK)
- 47 APPLE INC., a California corporation, Plaintiffs, v. SAMSUNG ELECTRONICS CO., LTD., a Korean business entity, Samsung Electronics America, Inc., a New York corporation, and Samsung Telecommunications America, LLC, a Delaware limited liability company, Defendants., 2011 WL 7464351 (Expert Report and Affidavit) (N.D.Cal. Nov. 14, 2011) **Declaration of Tony Givargis, Ph.D. in Support of Apple's Proposed Claim Construction for U.S. Patent No. 7,698,711** (NO. 11-CV-01846-LHK)
- 48 APPLE INC., a California corporation, Plaintiff, v. SAMSUNG ELECTRONICS CO., LTD., a Korean business entity; Samsung Electronics America, Inc., a New York corporation; Samsung Telecommunications America, LLC, a Delaware limited liability company, Defendants., 2011

- WL 7464352 (Expert Report and Affidavit) (N.D.Cal. Nov. 28, 2011) **Declaration of Richard Wesel in Support of Samsung's Proposed Claim Construction For U.S. Patent No. 7,200,792** (NO. 11-CV-01846-LHK)
- 49 APPLE INC., a California corporation, Plaintiff, v. SAMSUNG ELECTRONICS CO., LTD., a Korean business entity; Samsung Electronics America, Inc., a New York corporation; Samsung Telecommunications America, LLC, a Delaware limited liability company, Defendants., 2011 WL 7464348 (Partial Expert Testimony) (N.D.Cal. Nov. 29, 2011) **Videotaped Deposition of Nicholas Godici San Francisco, California** (NO. 11-CV-01846-LHK)
- 50 APPLE INC., a California corporation, Plaintiff, v. SAMSUNG ELECTRONICS CO., LTD., a Korean business entity; Samsung Electronics America, Inc., a New York corporation; Samsung Telecommunications America, LLC, a Delaware limited liability company, Defendants., 2011 WL 7464349 (Partial Expert Testimony) (N.D.Cal. Dec. 7, 2011) **Videotaped Deposition of Cooper Woodring Redwood Shores, California** (NO. 11-CV-01846-LHK)
- 51 APPLE INC., a California corporation, Plaintiff, v. SAMSUNG ELECTRONICS CO., LTD., a Korean business entity, Samsung Electronics America, Inc., a New York corporation, and Samsung Telecommunications America, LLC, a Delaware limited liability company, Defendants; Samsung Electronics Co., Ltd., a Korea, 2011 WL 7464350 (Expert Report and Affidavit) (N.D.Cal. Dec. 20, 2011) **Declaration of Professor Nicolas Molfessis in Support of Apple Inc.'s Opposition to Samsung's Motion to Dismiss Apple's Counterclaims** (NO. 11-CV-01846-LHK)
- 52 APPLE INC., a California corporation, Plaintiff, v. SAMSUNG ELECTRONICS CO., LTD., a Korean business entity; Samsung Electronics America, Inc., a New York corporation; Samsung Telecommunications America, LLC, a Delaware limited liability company, Defendants., 2012 WL 756594 (Partial Expert Testimony) (N.D.Cal. Jan. 6, 2012) **Videotaped Deposition of Richard D. Gitlin, Sc.D.** (NO. 11-CV-01846-LHK)
- 53 APPLE INC., a California corporation, Plaintiff, v. SAMSUNG ELECTRONICS CO., LTD., a Korean business entity; Samsung Electronics America, Inc., a New York corporation; Samsung Telecommunications America, LLC, a Delaware limited liability company, Defendant., 2012 WL 756595 (Expert Report and Affidavit) (N.D.Cal. Jan. 9, 2012) **Declaration of Professor Remy Libchaber in Support of Defendant Samsung's Reply Memorandum** (NO. 11-CV-01846-LHK)

#### N.D.Cal. Trial Motions, Memoranda And Affidavits

- 54 APPLE INC., a California corporation, Plaintiff, v. SAMSUNG ELECTRONICS CO., LTD., a Korean business entity; Samsung Electronics America, Inc., a New York corporation; Samsung Telecommunications America, LLC, a Delaware limited liability company, Defendants., 2011 WL 1938580 (Trial Motion, Memorandum and Affidavit) (N.D.Cal. May 12, 2011) **Samsung's Opposition to Plaintiff's Motion to Expedite Discovery** (NO. 11-CV-01846-LHK)
- 55 APPLE INC., a California corporation, Plaintiff, v. SAMSUNG ELECTRONICS CO., LTD., a Korean business entity; Samsung Electronics America, Inc., a New York corporation; Samsung Telecommunications America, LLC, a Delaware limited liability company, Defendants., 2011 WL 1938577 (Trial Motion, Memorandum and Affidavit) (N.D.Cal. May 16, 2011) **Apple Inc.'s Opposition to Samsung's Civil L.R. 3-12(B) Motion to Consider Whether Cases Should Be**

**Related (NO. 11-CV-01846-LHK)**

- 56 APPLE INC., a California corporation, Plaintiff, v. SAMSUNG ELECTRONICS CO., LTD., a Korean business entity; Samsung Electronics America, Inc., a New York corporation; Samsung Telecommunications America, LLC, a Delaware limited liability company, Defendants., 2011 WL 1938583 (Trial Motion, Memorandum and Affidavit) (N.D.Cal. May 18, 2011) **Samsung's Reply in Support of Its Civil L.R. 3-12(b) Motion to Consider Whether Cases Should be Related** (NO. 11-CV-01846-LHK)
- 57 APPLE INC., a California corporation, Plaintiff, v. SAMSUNG ELECTRONICS CO., LTD., a Korean business entity; Samsung Electronics America, Inc., a New York corporation; Samsung Telecommunications America, LLC, a Delaware limited liability company, Defendants., 2011 WL 2138428 (Trial Motion, Memorandum and Affidavit) (N.D.Cal. May 27, 2011) **Samsung's Motion to Compel Apple to Produce Reciprocal Expedited Discovery** (NO. 11-CV-01846-LHK)
- 58 APPLE INC., a California corporation, Plaintiff, v. SAMSUNG ELECTRONICS CO., LTD., a Korean business entity; SAMSUNG Electronics America, Inc., a New York corporation; Samsung Telecommunications America, LLC, a Delaware limited liability company, Defendants., 2011 WL 2165216 (Trial Motion, Memorandum and Affidavit) (N.D.Cal. May 27, 2011) **Samsung's Motion to Compel Apple to Produce Reciprocal Expedited Discovery** (NO. 11-CV-01846-LHK)
- 59 APPLE INC., a California corporation, Plaintiff, v. SAMSUNG ELECTRONICS CO., LTD., a Korean business entity; Electronics America, Inc., a New York corporation; Samsung Telecommunications America, LLC, a Delaware limited liability company, Defendants., 2011 WL 2165218 (Trial Motion, Memorandum and Affidavit) (N.D.Cal. May 27, 2011) **Declaration of Todd M. Briggs in Support of Samsung's Motion to Compel Apple to Produce Samsung Reciprocal Expedited Discovery and Unopposed Civil L.R. 6-3 Motion to Shorten Time** (NO. 11-CV-01846-LHK)
- 60 APPLE INC., a California corporation, Plaintiff, v. SAMSUNG ELECTRONICS CO., LTD., a Korean business entity; Samsung Electronics America, Inc., a New York corporation; Samsung Telecommunications America, LLC, a Delaware limited liability company, Defendants., 2011 WL 2429022 (Trial Motion, Memorandum and Affidavit) (N.D.Cal. Jun. 10, 2011) **Samsung's Reply in Support of Its Motion to Compel Apple to Produce Reciprocal Expedited Discovery** (NO. 11-CV-01846-LHK)
- 61 APPLE INC., a California corporation, Plaintiff, v. SAMSUNG ELECTRONICS CO., LTD., a Korean corporation; Samsung Electronics America, Inc., a New York corporation; and Samsung Telecommunications America, LLC, a Delaware limited liability company, Defendants., 2011 WL 2587280 (Trial Motion, Memorandum and Affidavit) (N.D.Cal. Jul. 1, 2011) **Apple Inc.'s Motion for A Preliminary Injunction** (NO. 11-CV-01846-LHK)
- 62 APPLE INC., a California corporation, Plaintiff, v. SAMSUNG ELECTRONICS CO., LTD., a Korean corporation; Samsung Electronics America, Inc., a New York corporation; and Samsung Telecommunications America, LLC, a Delaware limited liability company, Defendants., 2011 WL 2731807 (Trial Motion, Memorandum and Affidavit) (N.D.Cal. Jul. 1, 2011) **Apple's Motion for Expedited Trial on its Claims and for Early Case Management Conference** (NO. 11-CV-01846-LHK)



- 63 APPLE INC., a California corporation, Plaintiff, v. SAMSUNG ELECTRONICS CO., LTD., a Korean corporation; SAMSUNG Electronics America, Inc., a New York corporation; and Samsung Telecommunications America, LLC, a Delaware limited liability company, Defendants., 2011 WL 2731811 (Trial Motion, Memorandum and Affidavit) (N.D.Cal. Jul. 1, 2011) **Apple Inc.'s Motion for A Preliminary Injunction** (NO. 11-CV-01846-LHK)
- 64 APPLE INC., a California corporation, Plaintiff, vs. SAMSUNG ELECTRONICS CO., LTD., a Korean business entity; Samsung Electronics America, Inc., a New York corporation; Samsung Telecommunications America, LLC, a Delaware limited liability company, Defendants., 2011 WL 2731805 (Trial Motion, Memorandum and Affidavit) (N.D.Cal. Jul. 11, 2011) **Samsung's Motion to Disqualify Bridges & Mavrakakis LLP** (NO. 11-CV-01846-LHK)
- 65 APPLE INC., a California corporation, Plaintiff, v. SAMSUNG ELECTRONICS CO., Ltd., a Korean business entity; Samsung Electronics America, Inc., a New York corporation; Samsung Telecommunications America, LLC, a Delaware limited liability company, Defendants., 2011 WL 3205720 (Trial Motion, Memorandum and Affidavit) (N.D.Cal. Jul. 15, 2011) **Samsung's Opposition to Apple's Motion for Expedited Trial on its Claims and for Early Case Management Conference** (NO. 11-CV-01846-LHK)
- 66 APPLE INC., a California corporation, Plaintiff, v. SAMSUNG ELECTRONICS CO., LTD., a Korean corporation; Samsung Electronics America, Inc., a New York corporation; and Samsung Telecommunications America, LLC, a Delaware limited liability company, Defendants., 2011 WL 3205725 (Trial Motion, Memorandum and Affidavit) (N.D.Cal. Jul. 22, 2011) **Apple's Reply in Support of Motion for Expedited Trial on its Claims** (NO. 11-CV-01846-LHK)
- 67 APPLE INC., Plaintiff, v. SAMSUNG ELECTRONICS CO., LTD., a Korean corporation; Samsung Electronics America, Inc., a new York corporation; and Samsung Telecommunications America, LLC, a Delaware limited liability company, Defendants., 2011 WL 3515736 (Trial Motion, Memorandum and Affidavit) (N.D.Cal. Aug. 1, 2011) **Opposition to Defendants' Motion to Disqualify Bridges & Mavrakakis, LLP** (NO. C-11-01846 (LHK))
- 68 APPLE INC., Plaintiff, v. SAMSUNG ELECTRONICS CO., LTD., a Korean corporation; Samsung Electronics America, Inc., a new York corporation; and Samsung Telecommunications America, LLC, a Delaware limited liability company, Defendants., 2011 WL 3515740 (Trial Motion, Memorandum and Affidavit) (N.D.Cal. Aug. 1, 2011) **Declaration of Kenneth H. Bridges in Support of the Opposition to Defendants' Motion to Disqualify Bridges & Mavrakakis, LLP** (NO. C-11-01846 (LHK))
- 69 APPLE INC., a California corporation, Plaintiff, v. SAMSUNG ELECTRONICS CO., LTD., a Korean business entity; Samsung Electronics America, Inc., a New York corporation; Samsung Telecommunications America, LLC, a Delaware limited liability company, Defendants., 2011 WL 3754415 (Trial Motion, Memorandum and Affidavit) (N.D.Cal. Aug. 15, 2011) **Samsung's Motion to Dismiss and Strike Apple's Counterclaims** (NO. 11-CV-01846-LHK)
- 70 APPLE INC., a California corporation, Plaintiff, v. SAMSUNG ELECTRONICS CO., LTD., a Korean business entity; Samsung Electronics America, Inc., a New York corporation; Samsung Telecommunications America, LLC, a Delaware limited liability company, Defendants., 2011 WL 3754442 (Trial Motion, Memorandum and Affidavit) (N.D.Cal. Aug. 16, 2011) **Declaration of Roger Fidler in Support of Samsung's Opposition to Apple's Motion for Preliminary Injunction** (NO. 11-CV-01846-LHK)

- 71 APPLE INC., a California corporation, Plaintiff, v. SAMSUNG ELECTRONICS CO., LTD., a Korean business entity; Samsung Electronics America, Inc., a New York corporation; Samsung Telecommunications America, LLC, a Delaware limited liability company, Defendant., 2011 WL 3754435 (Trial Motion, Memorandum and Affidavit) (N.D.Cal. Aug. 20, 2011) **Declaration of Benjamin B. Bederson** (NO. 11-CV-01846-LHK)
- 72 APPLE INC., a California corporation, Plaintiff, v. SAMSUNG ELECTRONICS CO., LTD., a Korean business entity, Samsung Electronics America, Inc., a New York corporation, and Samsung Telecommunications America, LLC, a Delaware limited liability company, Defendants; Samsung Electronics Co., Ltd., a Kore, 2011 WL 3961358 (Trial Motion, Memorandum and Affidavit) (N.D.Cal. Aug. 29, 2011) **Apple Inc.'s Memorandum of Points and Authorities in Opposition to Samsung's Motion to Dismiss and Strike Apple's Counterclaims** (NO. 11-CV-01846-LHK)
- 73 APPLE INC., a California corporation, Plaintiff, v. SAMSUNG ELECTRONICS CO., LTD., a Korean business entity; Samsung Electronics America, Inc., a New York corporation; Samsung Telecommunications America, Llc, a Delaware limited liability company, Defendants., 2011 WL 3961359 (Trial Motion, Memorandum and Affidavit) (N.D.Cal. Sep. 1, 2011) **Samsung's Motion to Compel Apple to Produce Documents and Things in Response to Samsung's Request for Production No. 1 and Further Responses to Interrogatories Nos. 1, 3, and 6** (NO. 11-CV-01846-LHK)
- 74 APPLE INC., a California corporation, Plaintiff, v. SAMSUNG ELECTRONICS CO., LTD., a Korean business entity; Samsung Electronics America, Inc., a New York corporation; Samsung Telecommunications America, LLC, a Delaware limited liability company, Defendants., 2011 WL 3961361 (Trial Motion, Memorandum and Affidavit) (N.D.Cal. Sep. 6, 2011) **Samsung's Reply Brief in Support of Samsung's Motion to Dismiss and Strike Apple's Counterclaims** (NO. 11-CV-01846-LHK)
- 75 APPLE INC., a California corporation, Plaintiff, v. SAMSUNG ELECTRONICS CO., LTD., a Korean corporation; Samsung Electronics America, Inc., a new York corporation; and Samsung Telecommunications America, LLC, a Delaware limited liability company, Defendants., 2011 WL 4403830 (Trial Motion, Memorandum and Affidavit) (N.D.Cal. Sep. 12, 2011) **Public Redacted Version** (NO. 11-CV-01846-LHK)
- 76 APPLE INC., a California corporation, Plaintiff, v. SAMSUNG ELECTRONICS CO., LTD., a Korean business entity; Samsung Electronics America, Inc., a New York corporation; Samsung Telecommunications America, LLC, a Delaware limited liability company, Defendants., 2011 WL 4403832 (Trial Motion, Memorandum and Affidavit) (N.D.Cal. Sep. 12, 2011) **Samsung's Reply in Support of Its Motion to Compel** (NO. 11-CV-01846-LHK)
- 77 APPLE INC., a California corporation, Plaintiff, v. SAMSUNG ELECTRONICS CO, LTD., a Korean business entity; Samsung Electronics America, Inc., aNew York corporation; Samsung Telecommunications America, LLC, a Delaware limited liability company, Defendants., 2011 WL 4403834 (Trial Motion, Memorandum and Affidavit) (N.D.Cal. Sep. 14, 2011) **Reply in Support of Samsung's Motion to Disqualify Bridges & Mavrakakis LLP** (NO. 11-CV-01846-LHK)
- 78 APPLE INC., a California corporation, Plaintiff, v. SAMSUNG ELECTRONICS CO., LTD., a Korean corporation; Samsung Electronics America, Inc., a New York corporation; and Samsung

- Telecommunications America, LLC, a Delaware limited liability company, Defendants., 2011 WL 4403835 (Trial Motion, Memorandum and Affidavit) (N.D.Cal. Sep. 19, 2011) **Apple's Opposition to Samsung's Motion to Exclude Ordinary Observer Opinions of Apple Expert Cooper Woodring** (NO. 11-CV-01846-LHK)
- 79 APPLE INC., a California corporation, Plaintiff, v. SAMSUNG ELECTRONICS CO., LTD., a Korean business entity; Samsung Electronics America, Inc., a New York corporation; Samsung Telecommunications America, LLC, a Delaware limited liability company, Defendants., 2011 WL 4435266 (Trial Motion, Memorandum and Affidavit) (N.D.Cal. Sep. 23, 2011) **Brief of Amicus Curiae Celco Partnership Regarding Apple's Motion for a Preliminary Injunction** (NO. 11-CV-01846-LHK)
- 80 APPLE INC., a California corporation, Plaintiff, v. SAMSUNG ELECTRONICS CO., Ltd., a Korean business entity; Samsung Electronics America, Inc., a New York corporation; Samsung Telecommunications America, LLC, a Delaware limited liability company, Defendants., 2011 WL 4712019 (Trial Motion, Memorandum and Affidavit) (N.D.Cal. Sep. 26, 2011) **Samsung's Opposition to Apple's Motion to Compel** (NO. 11-CV-01846-LHK)
- 81 APPLE INC., a California corporation, Plaintiff, v. SAMSUNG ELECTRONICS CO., LTD., a Korean business entity; Samsung Electronics America, Inc., a New York corporation; SAMSUNG Time: 1:30 pm Telecommunications America, LLC, a Delaware limited liability company, Defendants., 2011 WL 4471243 (Trial Motion, Memorandum and Affidavit) (N.D.Cal. Sep. 28, 2011) **Brief of Amicus Curiae T-Mobile USA, Inc. Regarding Apple's Motion for a Preliminary Injunction** (NO. 11-CV-01846-LHK)
- 82 APPLE INC., a California corporation, Plaintiff, v. SAMSUNG ELECTRONICS CO., LTD., A Korean business entity; Samsung Electronics America, Inc., a New York corporation; Samsung Telecommunications America, LLC, a Delaware limited liability company, Defendants., 2011 WL 4712021 (Trial Motion, Memorandum and Affidavit) (N.D.Cal. Sep. 29, 2011) **Reply Declaration of Ravin Balakrishnan, Ph.D. in Support of Apple's Motion for a Preliminary Injunction** (NO. 11-CV-01846-LHK)
- 83 APPLE INC., a California corporation, Plaintiff, v. SAMSUNG ELECTRONICS CO., LTD., A Korean business entity; Samsung Electronics America, Inc., a New York corporation; Samsung Telecommunications America, LLC, a Delaware limited liability company, Defendants., 2011 WL 4712023 (Trial Motion, Memorandum and Affidavit) (N.D.Cal. Sep. 30, 2011) **Reply Declaration of Peter W. Bressler in Support of Apple's Motion for a Preliminary Injunction** (NO. 11-CV-01846-LHK)
- 84 APPLE INC., a California corporation, Plaintiff, v. SAMSUNG ELECTRONICS CO., LTD., a Korean business entity; Samsung Electronics America, Inc., a New York corporation; Samsung Telecommunications America, LLC, a Delaware limited liability company, Defendants., 2011 WL 4712022 (Trial Motion, Memorandum and Affidavit) (N.D.Cal. Oct. 1, 2011) **Samsung's Motion to Compel Apple to Schedule Inventor and Prosecuting Attorney Depositions** (NO. 11-CV-01846-LHK)
- 85 APPLE INC., a California corporation, Plaintiff, v. SAMSUNG ELECTRONICS CO., LTD., a Korean business entity; Samsung Electronics America, Inc., a new York corporation; Samsung Telecommunications America, LLC, a Delaware limited liability company, Defendants., 2011 WL 5007365 (Trial Motion, Memorandum and Affidavit) (N.D.Cal. Oct. 18, 2011) **Memor-**

- andum in Support of Samsung's Notice of Lodging of Materials in Opposition to Apple's Motion for Preliminary Injunction (NO. 11-CV-01846-LHK)**
- 86 APPLE INC., a California corporation, Plaintiff, v. SAMSUNG ELECTRONICS CO., LTD., a Korean business entity; Samsung Electronics America, Inc., a New York corporation; Samsung Telecommunications America, LLC, a Delaware limited liability company., Defendants., 2011 WL 5007369 (Trial Motion, Memorandum and Affidavit) (N.D.Cal. Oct. 18, 2011) **Apple's Motion to Compel Samsung to Produce Documents and Provide Responsive Answers to Pro-pounded Discovery (NO. 11-CV-01846-LHK)**
- 87 APPLE INC., a California corporation, Plaintiff, v. SAMSUNG ELECTRONICS CO., LTD., a Korean business entity; Samsung Electronics America, Inc., a New York corporation; Samsung Telecommunications America, LLC, a Delaware limited liability company, Defendant., 2011 WL 6002722 (Trial Motion, Memorandum and Affidavit) (N.D.Cal. Nov. 22, 2011) **Samsung's Motion to Dismiss Apple's Counterclaims (NO. 11-CV-01846-LHK)**
- 88 APPLE INC., a California corporation, Plaintiff, v. SAMSUNG ELECTRONICS CO., LTD., a Korean corporation; Samsung Electronics America, Inc., a New York corporation; and Samsung Telecommunications America, LLC, a Delaware limited liability company, Defendants., 2011 WL 6415697 (Trial Motion, Memorandum and Affidavit) (N.D.Cal. Nov. 28, 2011) **Apple's Reply in Support of Its Motion for a Preliminary Injunction (NO. 11-CV-01846-LHK)**
- 89 APPLE INC., a California corporation, Plaintiff, v. SAMSUNG ELECTRONICS CO., LTD., a Korean business entity; Samsung Electronics America, Inc., a New York corporation; Samsung Telecommunications America, LLC, a Delaware limited liability company, Defendants., 2011 WL 6415698 (Trial Motion, Memorandum and Affidavit) (N.D.Cal. Nov. 28, 2011) **Reply Declaration of Sanjay Sood in Support of Apple's Motion for a Preliminary Injunction (NO. 11-CV-01846-LHK)**
- 90 APPLE INC., a California corporation, Plaintiff, v. SAMSUNG ELECTRONICS CO., LTD., a Korean business entity; Samsung Electronics America, Inc., a New York corporation; Samsung Telecommunications America, LLC, a Delaware limited liability company, Defendants., 2011 WL 6415699 (Trial Motion, Memorandum and Affidavit) (N.D.Cal. Nov. 29, 2011) **Samsung's Opposition to Apple's Motion for a Preliminary Injunction (NO. 11-CV-01846-LHK)**
- 91 APPLE INC., a California corporation, Plaintiff, v. SAMSUNG ELECTRONICS CO., LTD., a Korean business entity; Samsung Electronics America, Inc., a New York corporation; Samsung Telecommunications America, LLC, a Delaware limited liability company, Defendants., 2011 WL 6415700 (Trial Motion, Memorandum and Affidavit) (N.D.Cal. Nov. 29, 2011) **Samsung's Notice of Motion and Motion to Exclude Ordinary Observer Opinions of Apple Expert Cooper Woodring; and Memorandum of Points and Authorities in Support (NO. 11-CV-01846-LHK)**
- 92 APPLE INC., a California corporation, Plaintiff, v. SAMSUNG ELECTRONICS CO., LTD., a Korean business entity; Samsung Electronics America, Inc., a New York corporation; Samsung Telecommunications America, LLC, a Delaware limited liability company, Defendants., 2011 WL 6415701 (Trial Motion, Memorandum and Affidavit) (N.D.Cal. Nov. 29, 2011) **Reply in Support of Samsung's Notice of Motion and Motion to Exclude Ordinary Observer Opinions of Apple Expert Cooper Woodring; and Memorandum of Points and Authorities in Support (NO. 11-CV-01846-LHK)**

- 93 APPLE INC., a California corporation, Plaintiff, v. SAMSUNG ELECTRONICS CO., LTD., a Korean corporation; Samsung Electronics America, Inc., a New York corporation; and Samsung Telecommunications America, LLC, a Delaware limited liability company, Defendants., 2011 WL 6415702 (Trial Motion, Memorandum and Affidavit) (N.D.Cal. Nov. 30, 2011) **Apple's Objections to Samsung's Untimely New Evidence Regarding Preliminary Injunction Motion** (NO. 11-CV-01846-LHK)
- 94 APPLE INC., a California corporation, Plaintiff, v. SAMSUNG ELECTRONICS CO., LTD., a Korean business entity; Samsung Electronics America, Inc., a New York corporation; Samsung Telecommunications America, LLC, a Delaware limited liability company, Defendants., 2011 WL 6482999 (Trial Motion, Memorandum and Affidavit) (N.D.Cal. Dec. 12, 2011) **Samsung's Notice of Motion and Motion to Permit Samsung's Expert Itay Sherman to Review Design Materials Designated Under the Protective Order** (NO. 11 -CV-01846-LHK)
- 95 APPLE INC., a California corporation, Plaintiff, v. SAMSUNG ELECTRONICS CO., LTD., a Korean corporation; Samsung Electronics America, Inc., a new York corporation; and Samsung Telecommunications America, LLC, a Delaware limited liability company, Defendants., 2011 WL 6483016 (Trial Motion, Memorandum and Affidavit) (N.D.Cal. Dec. 13, 2011) **Apple's Opposition to Samsung's Administrative Motion for Relief Regarding Lead Counsel Meet and Confer Requirement** (NO. 11-CV-01846-LHK (PSG))
- 96 APPLE INC., a California corporation, Plaintiff, v. SAMSUNG ELECTRONICS CO., LTD., a Korean business entity; Samsung Electronics America, Inc., a new York corporation; Samsung Telecommunications America, LLC, a Delaware limited liability company, Defendants., 2011 WL 6483029 (Trial Motion, Memorandum and Affidavit) (N.D.Cal. Dec. 20, 2011) **Samsung's Response to Apple's Supplemental Statement Concerning Samsung's Motion to Compel** (NO. 11-CV-01846-LHK)
- 97 APPLE INC., a California corporation, Plaintiff, v. SAMSUNG ELECTRONICS CO., LTD., a Korean business entity, Samsung Electronics America, Inc., a New York corporation, and Samsung Telecommunications America, LLC, a Delaware limited liability company, Defendants. Samsung Electronics Co., Ltd., a Kore, 2011 WL 7054017 (Trial Motion, Memorandum and Affidavit) (N.D.Cal. Dec. 20, 2011) **Apple Inc.'s Memorandum of Points and Authorities in Opposition to Samsung's Motion to Dismiss Apple's Counterclaims** (NO. 11-CV-01846-LHK)
- 98 APPLE INC., a California corporation, Plaintiff, v. SAMSUNG ELECTRONICS CO., LTD., a Korean business entity, Electronics America, Inc., a New York corporation, and Samsung Telecommunications America, LLC, a Delaware limited liability company, Defendants; Samsung Electronics Co., LTD., a Korean busin, 2011 WL 7101165 (Trial Motion, Memorandum and Affidavit) (N.D.Cal. Dec. 22, 2011) **Apple Inc.'s Motion to Strike Samsung Evidence Not Disclosed As Required by Patent Local Rule 4-3(b)** (NO. 11-CV-01846-LHK)
- 99 APPLE INC., a California corporation, Plaintiff, v. SAMSUNG ELECTRONICS CO., LTD., A Korean business entity; Samsung Electronics America, Inc., a New York corporation; Samsung Telecommunications America, LLC, a Delaware limited liability company, Defendants., 2011 WL 7054019 (Trial Motion, Memorandum and Affidavit) (N.D.Cal. Dec. 29, 2011) **Apple's Reply Claim Construction Brief Pursuant to Patent L.R. 4-5** (NO. 11-CV-01846-LHK)
- 100 APPLE INC., a California corporation, Plaintiff, v. SAMSUNG ELECTRONICS CO., LTD., a Korean business entity; Samsung Electronics America, Inc., a New York corporation; Samsung

- Telecommunications America, LLC, a Delaware limited liability company, Defendant., 2012 WL 246538 (Trial Motion, Memorandum and Affidavit) (N.D.Cal. Jan. 9, 2012) **Samsung's Reply Memorandum in Support Of Samsung's Motion to Dismiss Apple's Counterclaims** (NO. 11-CV-01846-LHK)
- 101 APPLE INC., a California corporation, Plaintiff, v. SAMSUNG ELECTRONICS CO., LTD., a Korean business entity, Samsung Electronics America, Inc., a New York corporation, and Samsung Telecommunications America, LLC, a Delaware limited liability company, Defendants; Samsung Electronics Co., Ltd., a Kore, 2012 WL 246546 (Trial Motion, Memorandum and Affidavit) (N.D.Cal. Jan. 11, 2012) **Apple Inc.'s Notice of Motion and Motion to Compel Discovery Relating to Apple's Affirmative Defenses and Counterclaims** (NO. 11-CV-01846-LHK)
- 102 APPLE INC., a California corporation, Plaintiff, v. SAMSUNG ELECTRONICS CO., LTD., a Korean business entity; Samsung Electronics America, Inc., a New York corporation; Samsung Telecommunications America, LLC, a Delaware limited liability company, Defendants., 2012 WL 246540 (Trial Motion, Memorandum and Affidavit) (N.D.Cal. Jan. 17, 2012) **Apple's Opposition to Samsung's Motion for a Protective Order** (NO. 11-CV-01846-LHK (PSG))
- 103 APPLE INC., a California corporation, Plaintiff, v. SAMSUNG ELECTRONICS CO., LTD., a Korean business entity; Samsung Electronics America, Inc., a New York corporation; Samsung Telecommunications America, LLC, a Delaware limited liability company, Defendants., 2012 WL 246548 (Trial Motion, Memorandum and Affidavit) (N.D.Cal. Jan. 17, 2012) **Apple's Opposition to Samsung's Motion for Clarification Regarding The Court's December 22, 2011 Order** (NO. 11-CV-01846-LHK (PSG))
- 104 APPLE INC., a California corporation, Plaintiff, v. SAMSUNG ELECTRONICS CO., LTD., a Korean business entity; Samsung Electronics America, Inc., a New York corporation; Samsung Telecommunications America, LLC, a Delaware limited liability company, Defendants., 2012 WL 246552 (Trial Motion, Memorandum and Affidavit) (N.D.Cal. Jan. 17, 2012) **Samsung's Opposition to Apple's Proposed Protective Order** (NO. 5:11-CV-01846-LHK)
- 105 APPLE INC., a California corporation, Plaintiff, v. SAMSUNG ELECTRONICS CO., LTD., A Korean business entity; Samsung Electronics America, Inc., a New York corporation; Samsung Telecommunications America, LLC, a Delaware limited liability company., Defendants., 2012 WL 246534 (Trial Motion, Memorandum and Affidavit) (N.D.Cal. Jan. 18, 2012) **Apple's Motion for Protective Order Regarding Samsung's First Rule 30(b)(6) Deposition Notice** (NO. 11-CV-01846-LHK (PSG))
- 106 APPLE INC., a California corporation, Plaintiff, v. SAMSUNG ELECTRONICS CO., LTD., A Korean business entity; Samsung Electronics America, Inc., a New York corporation; Samsung Date: Telecommunications America, LLC, a, Defendants., 2012 WL 246536 (Trial Motion, Memorandum and Affidavit) (N.D.Cal. Jan. 18, 2012) **Apple's Motion for Entry of Protective Order Regarding Disclosure and Use of Discovery Materials Delaware limited liability company** (NO. 11-CV-01846-LHK (PSG))
- 107 APPLE INC., a California corporation, Plaintiff, v. SAMSUNG ELECTRONICS CO., LTD., Korean business entity; Samsung Electronics America, Inc., a New York corporation; Samsung Telecommunications America, LLC, a Delaware limited liability company, Defendant., 2012 WL 246535 (Trial Motion, Memorandum and Affidavit) (N.D.Cal. Jan. 20, 2012) **Samsung's Reply Claim Construction Brief** (NO. 11-CV-01846-LHK)

- 108 APPLE INC., a California corporation, Plaintiff, v. SAMSUNG ELECTRONICS CO., LTD., a Korean business entity; Samsung Electronics America, Inc., a New York corporation; Samsung Telecommunications America, LLC, a Delaware limited liability company, Defendant., 2012 WL 246542 (Trial Motion, Memorandum and Affidavit) (N.D.Cal. Jan. 20, 2012) **Samsung's Opposition to Apple Inc.'s Motion to Strike Evidence Not Disclosed As Required By Patent Local Rule 4-3(b)** (NO. 11-CV-01846-LHK)
- 109 APPLE INC., a California corporation, Plaintiff, v. SAMSUNG ELECTRONICS CO., LTD., A Korean business entity; Samsung Electronics America, Inc., a New York corporation; Samsung Telecommunications America, LLC, a Delaware limited liability company., Defendants., 2012 WL 398494 (Trial Motion, Memorandum and Affidavit) (N.D.Cal. Jan. 27, 2012) **Declaration of Mia Mazza in Support of Apple's Motion to Compel Timely Production of Foreign-Language and Other Documents in Advance of Related Depositions** (NO. 11-CV-01846-LHK (PSG)
- 110 APPLE INC., a California corporation, Plaintiff, v. SAMSUNG ELECTRONICS CO., LTD., a Korean corporation; Samsung Electronics America, Inc., a New York corporation; and Samsung Telecommunications America, LLC, a Delaware limited liability company, Defendants., 2012 WL 398501 (Trial Motion, Memorandum and Affidavit) (N.D.Cal. Jan. 27, 2012) **Apple's Motion to Compel Timely Production of Foreign-Language and Other Documents in Advance of Related Depositions** (NO. 11-CV-01846-LHK)
- 111 APPLE INC., a California corporation, Plaintiff, v. SAMSUNG ELECTRONICS CO., LTD., a Korean business entity; Samsung Electronics America, Inc., a New York corporation; Samsung Telecommunications America, LLC, a Delaware limited liability company, Defendant., 2012 WL 398500 (Trial Motion, Memorandum and Affidavit) (N.D.Cal. Jan. 30, 2012) **Notice of Motion and Motion to Permit Samsung's Expert Samuel Lucente to Review Materials Designated Under the Prpctective Order** (NO. 11-CV-01846-LHK)
- 112 APPLE INC., a California corporation, Plaintiff, v. SAMSUNG ELECTRONICS CO., LTD., a Korean business entity; Samsung Electronics America, Inc., a New York corporation; Samsung Telecommunications America, LLC, a Delaware limited liability company, Defendant., 2012 WL 398497 (Trial Motion, Memorandum and Affidavit) (N.D.Cal. Jan. 31, 2012) **Samsung's Notice of Motion and Motion to Compel Apple to Respond to Samsung's Requests for Admission 101-190** (NO. 11-CV-01846-LHK)
- 113 APPLE INC., a California corporation, Plaintiff, v. SAMSUNG ELECTRONICS CO., LTD., a Korean business entity; Samsung Electronics America, Inc., a New York corporation; Samsung Telecommunications America, LLC, a Delaware limited liability company, Defendants., 2012 WL 602878 (Trial Motion, Memorandum and Affidavit) (N.D.Cal. Feb. 14, 2012) **Apple's Opposition to Samsung's Motion to Compel Apple to Respond to Samsung's Requests for Admission 101-190** (NO. 11-CV-01846-LHK (PSG)
- 114 APPLE INC., a California corporation, Plaintiff, v. SAMSUNG ELECTRONICS CO., LTD., a Korean business entity; Samsung Electronics America, Inc., a New York corporation; Samsung Telecommunications America, LLC, a Delaware limited liability company, Defendant., 2012 WL 602879 (Trial Motion, Memorandum and Affidavit) (N.D.Cal. Feb. 15, 2012) **Samsung's Opposition to Apple's Motion to Compel Timely Production of Foreign-Language and Other Documents in Advance of Related Depositions** (NO. 11-CV-01846-LHK)

- 115 APPLE INC., a California corporation, Plaintiff, v. SAMSUNG ELECTRONICS CO., LTD., a Korean business entity; Samsung Electronics America, Inc., a New York corporation; Samsung Telecommunications America, LLC, a Delaware limited liability company, Defendant., 2012 WL 733817 (Trial Motion, Memorandum and Affidavit) (N.D.Cal. Feb. 21, 2012) **Samsung's Reply in Support of Its Motion to Compel Apple to Respond to Samsung's Requests for Admission 101-190** (NO. 11-CV-01846-LHK)
- 116 APPLE INC., a California corporation, Plaintiff, v. SAMSUNG ELECTRONICS CO., LTD., a Korean corporation; Samsung Electronics America, Inc., a New York corporation; and Samsung Telecommunications America, LLC, a Delaware limited liability company, Defendants., 2012 WL 733810 (Trial Motion, Memorandum and Affidavit) (N.D.Cal. Feb. 23, 2012) **Apple's Corrected Reply in Support of Its Motion to Compel Timely Production of Foreign-Language and Other Documents in Advance of Related Depositions** (NO. 11-CV-01846-LHK)
- 117 APPLE INC., a California corporation, Plaintiff, v. SAMSUNG ELECTRONICS CO., LTD., a Korean corporation; Samsung Electronics America, Inc., a New York corporation; and Samsung Telecommunications America, LLC, a Delaware limited liability company, Defendants., 2012 WL 929866 (Trial Motion, Memorandum and Affidavit) (N.D.Cal. Mar. 9, 2012) **Apple's Rule 37(b)(2) Motion Based On Samsung's Violation of the Court's December 22, 2011 Order Regarding Source Code** (NO. 11-CV-01846-LHK)
- 118 APPLE INC., a California corporation, Plaintiff, v. SAMSUNG ELECTRONICS CO., Ltd., a Korean business entity; Samsung Electronics America, Inc., a New York corporation; Samsung Telecommunications America, Llc, a Delaware limited liability company, Defendant., 2012 WL 929867 (Trial Motion, Memorandum and Affidavit) (N.D.Cal. Mar. 12, 2012) **Samsung's Administrative Motion for Temporary Relief From the Lead Counsel Meet and Confer Requirement or Alternatively for an Extension of the Deadline to File Motions to Compel** (NO. 11-CV-01846-LHK)
- 119 APPLE INC., a California corporation, Plaintiff, v. SAMSUNG ELECTRONICS CO., Ltd., a Korean corporation; Samsung Electronics, America, Inc., a New York corporation; and Samsung Telecommunications America LLC, a Delaware limited liability company, Defendants., 2012 WL 929868 (Trial Motion, Memorandum and Affidavit) (N.D.Cal. Mar. 13, 2012) **Apple's Opposition to Samsung's Administrative Motion For Temporary Relief From The Lead Counsel Meet and Confer Requirement or Alternatively For an Extension of The Deadline to File Motions to Compel** (NO. 11-CV-01846-LHK (PSG)
- 120 APPLE INC., a California corporation, Plaintiff, v. SAMSUNG ELECTRONICS CO., LTD., a Korean business entity; Electronics America, Inc., a New York corporation; Samsung Telecommunications America, LLC, a Delaware limited liability company, Defendant., 2012 WL 929869 (Trial Motion, Memorandum and Affidavit) (N.D.Cal. Mar. 14, 2012) **Samsung's Reply in Support of Its Administrative Motion for Temporary Relief From the Lead Counsel Meet and Confer Requirement or Alternatively Samsung For An Extension of the Deadline to File Motions** (NO. 11-CV-01846-LHK)
- 121 APPLE INC., a California corporation, Plaintiff, v. SAMSUNG ELECTRONICS CO., LTD., a Korean business entity; Samsung Electronics America, Inc., a New York corporation; Samsung Telecommunications America, LLC, a Delaware limited liability company, Defendant., 2012 WL 1108802 (Trial Motion, Memorandum and Affidavit) (N.D.Cal. Mar. 23, 2012) **Samsung's Opposition to Apple's Rule 37(B)(2) Motion Based on Samsung's Alleged Violation of the**



**Court's December 22, 2011 Order Regarding Source Code (NO. 11-CV-01846-LHK)**

122 APPLE INC., a California corporation, Plaintiff, v. SAMSUNG ELECTRONICS CO., LTD., a Korean corporation; Samsung Electronics America, Inc., a New York corporation; and Samsung Telecommunications America, LLC, a Delaware limited liability company, Defendants., 2012 WL 1108805 (Trial Motion, Memorandum and Affidavit) (N.D.Cal. Mar. 30, 2012) **Apple's Reply Memorandum in Support of its Rule 37(b)(2) Motion Based on Samsung's Violation of the Court's December 22, 2011 Order Regarding Source Code (NO. 11-CV-01846-LHK (PSG)**

**N.D.Cal. Expert Resumes**

- 123 Cooper Coolidge Woodring, curriculum vitae filed in Apple Inc. v. Samsung Electronics Co. Ltd. et al, 2011 WL 7465032 (Court-filed Expert Resume) (N.D.Cal. Jul. 1, 2011) **Expert Resume of Cooper Coolidge Woodring (NO. 511CV01846)**
- 124 Ravin Balakrishnan, curriculum vitae filed in Apple Inc. v. Samsung Electronics Co. Ltd. et al, 2011 WL 7465033 (Court-filed Expert Resume) (N.D.Cal. Jul. 1, 2011) **Expert Resume of Ravin Balakrishnan (NO. 511CV01846)**
- 125 Nicholas P. Godici, curriculum vitae filed in Apple Inc. v. Samsung Electronics Co. Ltd. et al, 2011 WL 7465026 (Court-filed Expert Resume) (N.D.Cal. Aug. 22, 2011) **Expert Resume of Nicholas P. Godici (NO. 511CV01846)**
- 126 Andries van Dam, curriculum vitae filed in Apple Inc. v. Samsung Electronics Co. Ltd. et al, 2011 WL 7465027 (Court-filed Expert Resume) (N.D.Cal. Aug. 22, 2011) **Expert Resume of Andries van Dam (NO. 511CV01846)**
- 127 Michael J. Wagner, curriculum vitae filed in Apple Inc. v. Samsung Electronics Co. Ltd. et al, 2011 WL 7465028 (Court-filed Expert Resume) (N.D.Cal. Aug. 22, 2011) **Expert Resume of Michael J. Wagner (NO. 511CV01846)**
- 128 Sanjay Sood, curriculum vitae filed in Apple Inc. v. Samsung Electronics Co. Ltd. et al, 2011 WL 7465030 (Court-filed Expert Resume) (N.D.Cal. Sep. 2011) **Expert Resume of Sanjay Sood (NO. 511CV01846)**
- 129 Peter W. Bressler, curriculum vitae filed in Apple Inc. v. Samsung Electronics Co. Ltd. et al, 2011 WL 7465029 (Court-filed Expert Resume) (N.D.Cal. Sep. 30, 2011) **Expert Resume of Peter W. Bressler (NO. 511CV01846)**
- 130 Nicolas Molfessis, curriculum vitae filed in Apple Inc. v. Samsung Electronics Co. Ltd. et al, 2011 WL 7629601 (Court-filed Expert Resume) (N.D.Cal. Dec. 20, 2011) **Expert Resume of Nicolas Molfessis (NO. 511CV01846)**
- 131 Tony Givargis, curriculum vitae filed in Apple Inc. v. Samsung Electronics Co. Ltd. et al, 2011 WL 7465031 (Court-filed Expert Resume) (N.D.Cal. Dec. 22, 2011) **Expert Resume of Tony Givargis (NO. 511CV01846)**
- 132 Richard Dale Wesel, curriculum vitae filed in Apple Inc. v. Samsung Electronics Co. Ltd. et al, 2012 WL 759502 (Court-filed Expert Resume) (N.D.Cal. Jan. 6, 2012) **Expert Resume of Richard Dale Wesel (NO. 511CV01846)**
- 133 J. Tipton Cole, curriculum vitae filed in Apple Inc. v. Samsung Electronics Co. Ltd. et al, 2012 WL 759503 (Court-filed Expert Resume) (N.D.Cal. Jan. 6, 2012) **Expert Resume of J. Tipton**

**Cole** (NO. 511CV01846)

- 134 Samuel Anthony Michael Lucente, II., curriculum vitae filed in Apple Inc. v. Samsung Electronics Co. Ltd. et al, 2012 WL 609468 (Court-filed Expert Resume) (N.D.Cal. Jan. 30, 2012) **Expert Resume of Samuel Anthony Michael Lucente, II** (NO. 511CV01846)

**N.D.Cal. Trial Filings**

- 135 APPLE INC., a California corporation, Plaintiff, v. SAMSUNG ELECTRONICS CO., LTD., a Korean corporation; Samsung Electronics America, Inc., a New York corporation; and Samsung Telecommunications America, LLC, a Delaware limited liability company, Defendants., 2011 WL 3754397 (Trial Filing) (N.D.Cal. Aug. 19, 2011) **Initial Joint Case Management Conference Statement -- Corrected Version** (NO. 11-CV-01846-LHK)
- 136 APPLE INC., a California corporation, Plaintiff, v. SAMSUNG ELECTRONICS CO., LTD., a Korean corporation; Samsung Electronics America, Inc., a New York corporation; and Samsung Telecommunications America, LLC, a Delaware limited liability company, Defendants., 2012 WL 1343158 (Trial Filing) (N.D.Cal. Apr. 12, 2012) **Joint Case Management Conference Statement** (NO. 11-CV-01846-LHK)
- 137 APPLE INC., a California corporation, Plaintiff, v. SAMSUNG ELECTRONICS CO., LTD., a Korean business entity; Samsung Electronics America, Inc., a New York corporation; Samsung Telecommunications America, LLC, a Delaware limited liability company, Defendants., 2012 WL 1301171 (Trial Filing) (N.D.Cal. Apr. 16, 2012) **Joint Status Report** (NO. 11-CV-01846-LHK)

**Dockets (U.S.A.)**

**N.D.Cal.**

- 138 APPLE INC. v. SAMSUNG ELECTRONICS CO. LTD. ET AL, NO. 5:11cv01846 (Docket) (N.D.Cal. Apr. 15, 2011)

**Expert Court Documents (U.S.A.)**

**N.D.Cal. Expert Testimony**

- 139 APPLE INC., a California corporation, Plaintiff, v. SAMSUNG ELECTRONICS CO., LTD., A Korean business entity; Samsung Electronics America, Inc., a New York corporation; Samsung Telecommunications America, LLC, a Delaware limited liability company, Defendants., 2011 WL 7464353 (Expert Report and Affidavit) (N.D.Cal. Jun. 30, 2011) **Declaration of Cooper C. Woodring In Support of Apple's Motion for A Preliminary Injunction** (NO. 11-CV-01846-LHK)
- 140 APPLE INC., a California corporation, Plaintiff, v. SAMSUNG ELECTRONICS CO., LTD., A Korean business entity; Samsung Electronics America, Inc., a new York corporation; Samsung Telecommunications America, LLC, a Delaware limited liability company, Defendants., 2011 WL 7464354 (Expert Report and Affidavit) (N.D.Cal. Jun. 30, 2011) **Declaration of Ravin Balakrishnan, Ph.D. In Support of Apple's Motion for a preliminary Injunction** (NO.

- 11-CV-01846-LHK)
- 141 APPLE INC., a California corporation, Plaintiff, v. SAMSUNG ELECTRONICS CO., LTD., a Korean business entity; Samsung Electronics America, Inc., a New York corporation; Samsung Telecommunications America, LLC, a Delaware limited liability company, Defendants., 2011 WL 3754046 (Expert Report and Affidavit) (N.D.Cal. Aug. 20, 2011) **Declaration of Andries Van Dam, Ph.D. In Support of Samsung's Opposition to Apple's Motion for A preliminary Injunction** (NO. 11-CV-01846-LHK)
- 142 APPLE INC., a California corporation, Plaintiff, v. SAMSUNG ELECTRONICS CO., LTD., a Korean business entity; Samsung Electronics America, Inc., a New York corporation; Samsung Telecommunications America, LLC, a Delaware limited liability company, Defendants., 2011 WL 3754045 (Expert Report and Affidavit) (N.D.Cal. Aug. 22, 2011) **Declaration of Nicholas P. Godici In Support of Samsung's Opposition to Apple's Motion for A preliminary Injunction** (NO. 11-CV-01846-LHK)
- 143 APPLE INC., a California corporation, Plaintiff, v. SAMSUNG ELECTRONICS CO., LTD., a Korean business entity; Samsung Electronics America, Inc., a New York corporation; Samsung Telecommunications America, LLC, a Delaware limited liability company, Defendants., 2011 WL 3754047 (Expert Report and Affidavit) (N.D.Cal. Aug. 22, 2011) **Declaration of Itay Sherman in Support of Samsung's Opposition to Apple's Motion for a Preliminary Injunction** (NO. 11-CV-01846-LHK)
- 144 APPLE INC., a California corporation, Plaintiff, v. SAMSUNG ELECTRONICS CO., Ltd., a Korean business entity; Samsung Electronics America, Inc., a New York corporation; Samsung Telecommunications America, LLC, a Delaware limited liability company, Defendants., 2011 WL 6257997 (Expert Report and Affidavit) (N.D.Cal. Aug. 22, 2011) **Declaration of Jeffrey Johnson, Ph.D., in Support of Samsung's Opposition to Apple's Motion for A Preliminary Injunction** (NO. 11-CV-01846-LHK)
- 145 APPLE INC., a California corporation, Plaintiff, v. SAMSUNG ELECTRONICS CO., LTD., A Korean business entity; SAMSUNG Electronics America, Inc., a New York corporation; Samsung Telecommunications America, LLC, a Delaware limited liability company, Defendants., 2011 WL 7464345 (Expert Report and Affidavit) (N.D.Cal. Sep. 29, 2011) **Reply Declaration of Ravin Balakrishnan, Ph.D. in Support of Apple's Motion for A preliminary Injunction** (NO. 11-CV-01846-LHK)
- 146 APPLE INC., a California corporation, Plaintiff, v. SAMSUNG ELECTRONICS CO., LTD., A Korean business entity; Samsung Electronics America, Inc., a New York corporation; Samsung Telecommunications America, LLC, a Delaware limited liability company, Defendants., 2011 WL 7464346 (Expert Report and Affidavit) (N.D.Cal. Sep. 30, 2011) **Reply Declaration of Peter W. Bressler in Support of Apple's Motion for A preliminary Injunction** (NO. 11-CV-01846-LHK)
- 147 APPLE INC., a California corporation, Plaintiff, v. SAMSUNG ELECTRONICS CO., LTD., A Korean business entity; Samsung Electronics America, Inc., a New York corporation; Samsung Telecommunications America, LLC, a Delaware limited liability company, Defendants., 2011 WL 7464347 (Expert Report and Affidavit) (N.D.Cal. Sep. 30, 2011) **Reply Declaration of Cooper C. Woodring in Support of Apple's Motion for A preliminary Injunction** (NO. 11-CV-01846-LHK)

- 148 APPLE INC., a California corporation, Plaintiffs, v. SAMSUNG ELECTRONICS CO., LTD., a Korean business entity, Samsung Electronics America, Inc., a New York corporation, and Samsung Telecommunications America, LLC, a Delaware limited liability company, Defendants., 2011 WL 7464351 (Expert Report and Affidavit) (N.D.Cal. Nov. 14, 2011) **Declaration of Tony Givargis, Ph.D. in Support of Apple's Proposed Claim Construction for U.S. Patent No. 7,698,711** (NO. 11-CV-01846-LHK)
- 149 APPLE INC., a California corporation, Plaintiff, v. SAMSUNG ELECTRONICS CO., LTD., a Korean business entity; Samsung Electronics America, Inc., a New York corporation; Samsung Telecommunications America, LLC, a Delaware limited liability company, Defendants., 2011 WL 7464352 (Expert Report and Affidavit) (N.D.Cal. Nov. 28, 2011) **Declaration of Richard Wesel in Support of Samsung's Proposed Claim Construction For U.S. Patent No. 7,200,792** (NO. 11-CV-01846-LHK)
- 150 APPLE INC., a California corporation, Plaintiff, v. SAMSUNG ELECTRONICS CO., LTD., a Korean business entity; Samsung Electronics America, Inc., a New York corporation; Samsung Telecommunications America, LLC, a Delaware limited liability company, Defendants., 2011 WL 7464348 (Partial Expert Testimony) (N.D.Cal. Nov. 29, 2011) **Videotaped Deposition of Nicholas Godici San Francisco, California** (NO. 11-CV-01846-LHK)
- 151 APPLE INC., a California corporation, Plaintiff, v. SAMSUNG ELECTRONICS CO., LTD., a Korean business entity; Samsung Electronics America, Inc., a New York corporation; Samsung Telecommunications America, LLC, a Delaware limited liability company, Defendants., 2011 WL 7464349 (Partial Expert Testimony) (N.D.Cal. Dec. 7, 2011) **Videotaped Deposition of Cooper Woodring Redwood Shores, California** (NO. 11-CV-01846-LHK)
- 152 APPLE INC., a California corporation, Plaintiff, v. SAMSUNG ELECTRONICS CO., LTD., a Korean business entity, Samsung Electronics America, Inc., a New York corporation, and Samsung Telecommunications America, LLC, a Delaware limited liability company, Defendants; Samsung Electronics Co., Ltd., a Kore, 2011 WL 7464350 (Expert Report and Affidavit) (N.D.Cal. Dec. 20, 2011) **Declaration of Professor Nicolas Molfessis in Support of Apple Inc.'s Opposition to Samsung's Motion to Dismiss Apple's Counterclaims** (NO. 11-CV-01846-LHK)
- 153 APPLE INC., a California corporation, Plaintiff, v. SAMSUNG ELECTRONICS CO., LTD., a Korean business entity; Samsung Electronics America, Inc., a New York corporation; Samsung Telecommunications America, LLC, a Delaware limited liability company, Defendants.; 2012 WL 756594 (Partial Expert Testimony) (N.D.Cal. Jan. 6, 2012) **Videotaped Deposition of Richard D. Gitlin, Sc.D.** (NO. 11-CV-01846-LHK)
- 154 APPLE INC., a California corporation, Plaintiff, v. SAMSUNG ELECTRONICS CO., LTD., a Korean business entity; Samsung Electronics America, Inc., a New York corporation; Samsung Telecommunications America, LLC, a Delaware limited liability company, Defendant., 2012 WL 756595 (Expert Report and Affidavit) (N.D.Cal. Jan. 9, 2012) **Declaration of Professor Remy Libchaber in Support of Defendant Samsung's Reply Memorandum** (NO. 11-CV-01846-LHK)

**N.D.Cal. Trial Motions, Memoranda And Affidavits**

- 155 APPLE INC., a California corporation, Plaintiff, v. SAMSUNG ELECTRONICS CO., LTD., a

- Korean business entity; Samsung Electronics America, Inc., a New York corporation; Samsung Telecommunications America, LLC, a Delaware limited liability company, Defendants., 2011 WL 5007365 (Trial Motion, Memorandum and Affidavit) (N.D.Cal. Oct. 18, 2011) **Memorandum in Support of Samsung's Notice of Lodging of Materials in Opposition to Apple's Motion for Preliminary Injunction** (NO. 11-CV-01846-LHK)
- 156 APPLE INC., a California corporation, Plaintiff, v. SAMSUNG ELECTRONICS CO., LTD., a Korean corporation; Samsung Electronics America, Inc., a New York corporation; and Samsung Telecommunications America, LLC, a Delaware limited liability company, Defendants., 2011 WL 6415697 (Trial Motion, Memorandum and Affidavit) (N.D.Cal. Nov. 28, 2011) **Apple's Reply in Support of Its Motion for a Preliminary Injunction** (NO. 11-CV-01846-LHK)
- 157 APPLE INC., a California corporation, Plaintiff, v. SAMSUNG ELECTRONICS CO., LTD., A Korean business entity; Samsung Electronics America, Inc., a New York corporation; Samsung Telecommunications America, LLC, a Delaware limited liability company, Defendants., 2011 WL 6415698 (Trial Motion, Memorandum and Affidavit) (N.D.Cal. Nov. 28, 2011) **Reply Declaration of Sanjay Sood in Support of Apple's Motion for a Preliminary Injunction** (NO. 11-CV-01846-LHK)
- 158 APPLE INC., a California corporation, Plaintiff, v. SAMSUNG ELECTRONICS CO., LTD., a Korean business entity; Samsung Electronics America, Inc., a New York corporation; Samsung Telecommunications America, LLC, a Delaware limited liability company, Defendants., 2011 WL 6415699 (Trial Motion, Memorandum and Affidavit) (N.D.Cal. Nov. 29, 2011) **Samsung's Opposition to Apple's Motion for a Preliminary Injunction** (NO. 11-CV-01846-LHK)
- 159 APPLE INC., a California corporation, Plaintiff, v. SAMSUNG ELECTRONICS CO., LTD., a Korean business entity; Samsung Electronics America, Inc., a New York corporation; Samsung Telecommunications America, LLC, a Delaware limited liability company, Defendants., 2011 WL 6415700 (Trial Motion, Memorandum and Affidavit) (N.D.Cal. Nov. 29, 2011) **Samsung's Notice of Motion and Motion to Exclude Ordinary Observer Opinions of Apple Expert Cooper Woodring; and Memorandum of Points and Authorities in Support** (NO. 11-CV-01846-LHK)
- 160 APPLE INC., a California corporation, Plaintiff, v. SAMSUNG ELECTRONICS CO., LTD., a Korean business entity; Samsung Electronics America, Inc., a New York corporation; Samsung Telecommunications America, LLC, a Delaware limited liability company, Defendants., 2011 WL 6415701 (Trial Motion, Memorandum and Affidavit) (N.D.Cal. Nov. 29, 2011) **Reply in Support of Samsung's Notice of Motion and Motion to Exclude Ordinary Observer Opinions of Apple Expert Cooper Woodring; and Memorandum of Points and Authorities in Support** (NO. 11-CV-01846-LHK)
- 161 APPLE INC., a California corporation, Plaintiff, v. SAMSUNG ELECTRONICS CO., LTD., a Korean business entity; Samsung Electronics America, Inc., a New York corporation; Samsung Telecommunications America, LLC, a Delaware limited liability company, Defendants., 2011 WL 6482999 (Trial Motion, Memorandum and Affidavit) (N.D.Cal. Dec. 12, 2011) **Samsung's Notice of Motion and Motion to Permit Samsung's Expert Itay Sherman to Review Design Materials Designated Under the Protective Order** (NO. 11 -CV-01846-LHK)
- 162 APPLE INC., a California corporation, Plaintiff, v. SAMSUNG ELECTRONICS CO., LTD., a Korean business entity, Electronics America, Inc., a New York corporation, and Samsung Tele-

- communications America, LLC, a Delaware limited liability company, Defendants; Samsung Electronics Co., LTD., a Korean busin, 2011 WL 7101165 (Trial Motion, Memorandum and Affidavit) (N.D.Cal. Dec. 22, 2011) **Apple Inc.'s Motion to Strike Samsung Evidence Not Disclosed As Required by Patent Local Rule 4-3(b)** (NO. 11-CV-01846-LHK)
- 163 APPLE INC., a California corporation, Plaintiff, v. SAMSUNG ELECTRONICS CO., LTD., A Korean business entity; Samsung Electronics America, Inc., a New York corporation; Samsung Telecommunications America, LLC, a Delaware limited liability company, Defendants., 2011 WL 7054019 (Trial Motion, Memorandum and Affidavit) (N.D.Cal. Dec. 29, 2011) **Apple's Reply Claim Construction Brief Pursuant to Patent L.R. 4-5** (NO. 11-CV-01846-LHK)
- 164 APPLE INC., a California corporation, Plaintiff, v. SAMSUNG ELECTRONICS CO., LTD., a Korean business entity; Samsung Electronics America, Inc., a New York corporation; Samsung Telecommunications America, LLC, a Delaware limited liability company, Defendant., 2012 WL 398500 (Trial Motion, Memorandum and Affidavit) (N.D.Cal. Jan. 30, 2012) **Notice of Motion and Motion to Permit Samsung's Expert Samuel Lucente to Review Materials Designated Under the Prpctective Order** (NO. 11-CV-01846-LHK)

#### N.D.Cal. Expert Resumes

- 165 Cooper Coolidge Woodring, curriculum vitae filed in Apple Inc. v. Samsung Electronics Co. Ltd. et al, 2011 WL 7465032 (Court-filed Expert Resume) (N.D.Cal. Jul. 1, 2011) **Expert Resume of Cooper Coolidge Woodring** (NO. 511CV01846)
- 166 Ravin Balakrishnan, curriculum vitae filed in Apple Inc. v. Samsung Electronics Co. Ltd. et al, 2011 WL 7465033 (Court-filed Expert Resume) (N.D.Cal. Jul. 1, 2011) **Expert Resume of Ravin Balakrishnan** (NO. 511CV01846)
- 167 Nicholas P. Godici, curriculum vitae filed in Apple Inc. v. Samsung Electronics Co. Ltd. et al, 2011 WL 7465026 (Court-filed Expert Resume) (N.D.Cal. Aug. 22, 2011) **Expert Resume of Nicholas P. Godici** (NO. 511CV01846)
- 168 Andries van Dam, curriculum vitae filed in Apple Inc. v. Samsung Electronics Co. Ltd. et al, 2011 WL 7465027 (Court-filed Expert Resume) (N.D.Cal. Aug. 22, 2011) **Expert Resume of Andries van Dam** (NO. 511CV01846)
- 169 Michael J. Wagner, curriculum vitae filed in Apple Inc. v. Samsung Electronics Co. Ltd. et al, 2011 WL 7465028 (Court-filed Expert Resume) (N.D.Cal. Aug. 22, 2011) **Expert Resume of Michael J. Wagner** (NO. 511CV01846)
- 170 Sanjay Sood, curriculum vitae filed in Apple Inc. v. Samsung Electronics Co. Ltd. et al, 2011 WL 7465030 (Court-filed Expert Resume) (N.D.Cal. Sep. 2011) **Expert Resume of Sanjay Sood** (NO. 511CV01846)
- 171 Peter W. Bressler, curriculum vitae filed in Apple Inc. v. Samsung Electronics Co. Ltd. et al, 2011 WL 7465029 (Court-filed Expert Resume) (N.D.Cal. Sep. 30, 2011) **Expert Resume of Peter W. Bressler** (NO. 511CV01846)
- 172 Nicolas Molfessis, curriculum vitae filed in Apple Inc. v. Samsung Electronics Co. Ltd. et al, 2011 WL 7629601 (Court-filed Expert Resume) (N.D.Cal. Dec. 20, 2011) **Expert Resume of Nicolas Molfessis** (NO. 511CV01846)
- 173 Tony Givargis, curriculum vitae filed in Apple Inc. v. Samsung Electronics Co. Ltd. et al, 2011

- WL 7465031 (Court-filed Expert Resume) (N.D.Cal. Dec. 22, 2011) **Expert Resume of Tony Givargis** (NO. 511CV01846)
- 174 Richard Dale Wesel, curriculum vitae filed in Apple Inc. v. Samsung Electronics Co. Ltd. et al, 2012 WL 759502 (Court-filed Expert Resume) (N.D.Cal. Jan. 6, 2012) **Expert Resume of Richard Dale Wesel** (NO. 511CV01846)
- 175 J. Tipton Cole, curriculum vitae filed in Apple Inc. v. Samsung Electronics Co. Ltd. et al, 2012 WL 759503 (Court-filed Expert Resume) (N.D.Cal. Jan. 6, 2012) **Expert Resume of J. Tipton Cole** (NO. 511CV01846)
- 176 Samuel Anthony Michael Lucente, II., curriculum vitae filed in Apple Inc. v. Samsung Electronics Co. Ltd. et al, 2012 WL 609468 (Court-filed Expert Resume) (N.D.Cal. Jan. 30, 2012) **Expert Resume of Samuel Anthony Michael Lucente, II** (NO. 511CV01846)

**N.D.Cal.**

- 177 APPLE INC. v. SAMSUNG ELECTRONICS CO. LTD. ET AL, NO. 5:11cv01846 (Docket) (N.D.Cal. Apr. 15, 2011)

**Patent Family**

- 178 COMPUTER-IMPLEMENTED LIST SCROLLING METHOD FOR USE WITH E.G. MOBILE PHONE, INVOLVES TRANSLATING DOCUMENT IN DIRECTION WHEN OBJECT IS NO LONGER DETECTED ON OR NEAR DISPLAY AND AREA BEYOND EDGE OF DOCUMENT IS NOT DISPLAYED, Derwent World Patents Legal 2008-H73568+
- 179 PORTABLE MULTIFUNCTION DEVICE I.E. PORTABLE COMMUNICATION DEVICE, FOR E.G. DIGITAL CAMERA APPLICATION, HAS ELECTRONIC DOCUMENT E.G. WEB PAGE, WHERE AREAS BEYOND OPPOSITE EDGES OF DOCUMENT ARE NOT DISPLAYED IF GESTURE TERMINATION IS FOUND, Derwent World Patents Legal 2009-F92382
- 180 PORTABLE MULTIFUNCTION DEVICE E.G. MOBILE TELEPHONE, FOR E.G. TELEPHONE APPLICATION, HAS TOUCH SCREEN DISPLAY DISPLAYING RESPECTIVE PORTION OF DOCUMENT AT PREDEFINED MAGNIFICATION UPON DETECTING TERMINATION OF GESTURE, Derwent World Patents Legal 2009-F93873
- 181 PORTABLE MULTIFUNCTION DEVICE I.E. MOBILE TELEPHONE, FOR TRANSLATING AND SCALING E.G. DIGITAL IMAGE, HAS MEMORY WITH SET OF INSTRUCTIONS FOR TRANSLATING DOCUMENT IN DIRECTION UNTIL AREA BEYOND EDGE OF DOCUMENT IS NO LONGER DISPLAYED, Derwent World Patents Legal 2009-G15384
- 182 PORTABLE ELECTRONIC DEVICE E.G. CELLULAR PHONE, HAS ONE OR MORE PROGRAMS THAT SCROLL LIST IN SECOND DIRECTION UNTIL AREA BEYOND TERMINUS OF LIST IS NO LONGER DISPLAYED, IN RESPONSE TO DETECTING THAT OBJECT IS NO LONGER ON OR NEAR DISPLAY, Derwent World Patents Legal 2009-G16576
- 183 PORTABLE MULTI-FUNCTION DEVICE E.G. MOBILE PHONE PERFORMS RIGHT-ANGLED OR ACUTE ANGLED SCREEN ROTATION COMMAND ACCORDING TO DEGREE OF ROTATION OF MULTIFINGER TWISTING GESTURE ON OR NEAR TOUCH SCREEN, Derwent World Patents Legal 2009-H72191

**Assignments**

184 Action: ASSIGNMENT OF ASSIGNORS INTEREST (SEE DOCUMENT FOR DETAILS).  
Number of Pages: 002, (DATE RECORDED: Aug 15, 2008)

**Patent Status Files**

- .. Re-Examination Certificate, (OG DATE: Apr 26, 2011)
- .. Request for Re-Examination, (OG DATE: Jul 13, 2010)
- .. Certificate of Correction, (OG DATE: Mar 10, 2009)

**Docket Summaries**

188 APPLE INC. v. HIGH TECH COMPUTER CORP. ET AL, (D.DEL. Mar 02, 2010) (NO. 1:10CV00167), (35 USC 271 PATENT INFRINGEMENT)

**Litigation Alert**

189 Derwent LitAlert P2010-11-20 (Mar 02, 2010) Action Taken: complaint

**Prior Art (Coverage Begins 1976)**

- C** 190 APPARATUS FOR MANIPULATING AN OBJECT DISPLAYED ON A DISPLAY DEVICE BY USING A TOUCH SCREEN, US PAT 5844547Assignee: Fujitsu Limited, (U.S. PTO Utility 1998)
- C** 191 AUTOMATIC SCROLLING, US PAT 6975306Assignee: Microsoft Corporation, (U.S. PTO Utility 2005)
- C** 192 AUTOMATICALLY SCROLLING HANDWRITTEN INPUT USER INTERFACE FOR PERSONAL DIGITAL ASSISTANTS AND THE LIKE, US PAT 6661409Assignee: Motorola, Inc., (U.S. PTO Utility 2003)
- C** 193 DATA PROCESSING APPARATUS FOR SCROLLING A DISPLAY IMAGE BY DESIGNATING A POINT WITHIN THE VISUAL DISPLAY REGION, US PAT 5867158Assignee: Sharp Kabushiki Kaisha, (U.S. PTO Utility 1999)
- C** 194 DISPLAY APPARATUS AND PORTABLE INFORMATION PROCESSING APPARATUS, US PAT 6809724Assignee: Seiko Epson Corporation, (U.S. PTO Utility 2004)
- C** 195 FORM FACTOR FOR PORTABLE DEVICE, US PAT 7009599Assignee: Nokia Corporation, (U.S. PTO Utility 2006)
- C** 196 IMAGE INPUT APPARATUS, PROGRAM EXECUTED BY COMPUTER, AND METHOD FOR PREPARING DOCUMENT WITH IMAGE, US PAT 7154534Assignee: Ricoh Company, Ltd., (U.S. PTO Utility 2006)
- C** 197 INFORMATION PROCESSING APPARATUS, INFORMATION PROCESSING METHOD AND PROGRAM STORAGE MEDIA, US PAT 6912462Assignee: Sony Corporation, (U.S. PTO Utility 2005)
- C** 198 MANUAL CONTROLLED SCROLLING, US PAT 6707449Assignee: Microsoft Corporation,



- (U.S. PTO Utility 2004)
- C** 199 METHOD AND APPARATUS FOR INTEGRATING MANUAL INPUT, US PAT 6323846 Assignee: University of Delaware, (U.S. PTO Utility 2001)
  - C** 200 METHOD AND SYSTEM FOR NAVIGATING A DISPLAY SCREEN FOR LOCATING A DESIRED ITEM OF INFORMATION, US PAT 7075512 Assignee: PalmSource, Inc., (U.S. PTO Utility 2006)
  - C** 201 METHOD AND SYSTEM FOR PROVIDING TOUCH- SENSITIVE SCREENS FOR THE VISUALLY IMPAIRED, US PAT 6489951 Assignee: Microsoft Corporation, (U.S. PTO Utility 2002)
  - C** 202 METHOD OF SCROLLING A DISPLAY WINDOW, US PAT 6907575 Assignee: Danger, Inc., (U.S. PTO Utility 2005)
  - C** 203 METHODS, SYSTEMS, AND COMPUTER PROGRAM PRODUCTS FOR DISPLAY OF INFORMATION RELATING TO A VIRTUAL THREE-DIMENSIONAL BOOK, US PAT 7240291 Assignee: Xerox Corporation, (U.S. PTO Utility 2007)
  - C** 204 MOVABLE TOUCH PAD WITH ADDED FUNCTIONALITY, US PAT APP 20050052425 (U.S. PTO Application 2005)
  - C** 205 MULTI-FUNCTION POINTING DEVICE, US PAT 7102626 Assignee: Hewlett-Packard Development Company, L.P., (U.S. PTO Utility 2006)
  - C** 206 MULTI-TOUCH SYSTEM AND METHOD FOR EMULATING MODIFIER KEYS VIA FINGERTIP CHORDS, US PAT 6570557 Assignee: Finger Works, Inc., (U.S. PTO Utility 2003)
  - C** 207 PCI RADIATION IMAGE PROCESSING APPARATUS, PCI RADIATION IMAGE DETECTING APPARATUS, PCI RADIATION IMAGE OUTPUTTING APPARATUS, AND PCI IMAGE DIAGNOSIS SUPPORTING APPARATUS, US PAT 7155048 Assignee: Konica Corporation, (U.S. PTO Utility 2006)
  - C** 208 PERSONAL COMMUNICATION DEVICE HAVING A BUILT IN PROJECTION DISPLAY, US PAT 7184796 Assignee: International Business Machines, (U.S. PTO Utility 2007)
  - C** 209 SCROLLING CONTENTS OF A WINDOW, US PAT 5495566 Assignee: Microsoft Corporation, (U.S. PTO Utility 1996)
  - C** 210 SCROLLING METHOD USING SCREEN POINTING DEVICE, US PAT 6972776 Assignee: Agilent Technologies, Inc., (U.S. PTO Utility 2005)
  - C** 211 SCROLLING NAVIGATIONAL DISPLAY SYSTEM, US PAT 6034688 Assignee: Sony Corporation; Sony Trans Com Inc., (U.S. PTO Utility 2000)
  - C** 212 SYSTEM AND METHODS FOR NAVIGATING AND VISUALIZING MULTI-DIMENSIONAL BIOLOGICAL DATA, US PAT 7181373 Assignee: Agilent Technologies, Inc., (U.S. PTO Utility 2007)
  - C** 213 TOUCH PAD FOR HANDHELD DEVICE, US PAT APP 20050110768 (U.S. PTO Application 2005)
  - C** 214 TOUCH PAD HANDHELD DEVICE, US PAT 7046230 Assignee: Apple Computer, Inc., (U.S. PTO Utility 2006)
  - C** 215 TOUCH PAD HANDHELD DEVICE, US PAT APP 20030076306 (U.S. PTO Application 2003)
  - C** 216 TOUCH-SCREEN IMAGE SCROLLING SYSTEM AND METHOD, US PAT

- C** 6690387 Assignee: Koninklijke Philips Electronics N.V., (U.S. PTO Utility 2004)  
217 TOUCH SCREEN USING PRESSURE TO CONTROL THE ZOOM RATIO, US PAT  
6567102 Assignee: Compal Electronics Inc., (U.S. PTO Utility 2003)

© 2012 Thomson Reuters. All rights reserved.

**US District Court Civil Docket**

**U.S. District - California Northern  
(San Jose)**

**5:11cv1846**

**Apple Inc v. Samsung Electronics Co Ltd et al**

This case was retrieved from the court on Thursday, June 14, 2012

<b>Date Filed: 04/15/2011</b>	<b>Class Code: OPEN</b>
<b>Assigned To: Honorable Lucy H Koh</b>	<b>Closed: No</b>
<b>Referred To: Magistrate Judge Paul Singh Grewal</b>	<b>Statute: 15:1125</b>
<b>Nature of suit: Patent (830)</b>	<b>Jury Demand: Both</b>
<b>Cause: Trademark Infringement (Lanham Act)</b>	<b>Demand Amount: \$0</b>
<b>Lead Docket: None</b>	<b>NOS Description: Patent</b>
<b>Other Docket: None</b>	
<b>Jurisdiction: Federal Question</b>	

**Litigants**

Apple Inc A California Corporation  
Plaintiff

**Attorneys**

Michael A Jacobs  
[COR LD NTC]  
Morrison & Foerster LLP  
425 Market Street  
San Francisco , CA 94105  
USA  
(415) 268-7455  
Fax: (415) 268-7522  
Email: Mjacobs@mofo.com

Samuel Calvin Walden  
[COR LD NTC]  
Wilmer Cutler Pickering Hale and Dorr LLP  
399 Park Avenue  
New York , NY 10022  
USA  
212-230-8800  
<i>pro Hac Vice</ I>

Timonthy D Syrett  
[COR LD NTC]  
60 State Street  
Boston , MA 02109  
USA  
617-526-6975  
<i>pro Hac Vice</ I>

Ali H Shah  
[COR LD NTC]  
Wilmer Cutler Pickering Hale and Dorr LLP  
1875 Pennsylvania Avenue NW  
Washington , DC 20006  
USA  
202-663-6064

Fax: 202-663-6363  
<i>pro Hac Vice</ I>  
Email: Ali.shah@wilmerhale.com

Alison Margaret Tucher  
[COR LD NTC]  
Morrison & Foerster LLP  
425 Market Street  
San Francisco , CA 94105  
USA  
415-268-7269  
Email: ATUCHER@MOFO.COM

Andrew L Liao  
[COR LD NTC]  
Wilmerhale  
950 Page Mill Rd  
Palo Alto , CA 94304  
USA  
650-858-6063  
Email: ANDREW.LIAO@WILMERHALE.COM

Andrew Ellis Monach  
[COR LD NTC]  
Morrison & Foerster LLP  
425 Market St  
San Francisco , CA 94105-2482  
USA  
(415) 268-7588  
Email: Amonach@mofo.com

Benjamin George Damstedt  
[COR LD NTC]  
Cooley Godward Kronish LLP  
Five Palo Alto Square  
3000 El Camino Real  
Palo Alto , CA 94306  
USA  
650-843-5000  
Fax: 650-857-0663  
Email: BDAMSTEDT@COOLEY.COM

Brian Larivee  
[COR LD NTC]  
Wilmer Cutler Pickering Hall and Dorr LLP  
60 State Street  
Boston , MA 02109  
USA  
617-526-6226  
<i>pro Hac Vice</ I>

Brian Seeve  
[COR LD NTC]  
60 State Street  
Boston , MA 02109  
USA  
617-526-6160  
<i>pro Hac Vice</ I>

Christine E Duh  
[COR LD NTC]  
Wilmer Hale  
950 Page Mill Road  
Palo Alto , CA 94304  
USA  
650-858-6051  
Fax: 650-858-6100

Email: CHRISTINE.DUH@WILMERHALE.COM

David B Bassett  
[COR LD NTC]  
Wilmercutler Pickering Hall and Dorr LLP  
399 Park Avenue  
New York , NY 10022  
USA  
(212) 230-8800  
Fax: (212) 230-8888  
<i>pro Hac Vice</ I>  
Email: DAVID.BASSETT@WILMERHALE.COM

Deok Keun Matthew AHN  
[COR LD NTC]  
Morrison & Foerster  
425 Market Street  
San Francisco , CA 94105  
USA  
415-268-6629  
Fax: 415-268-7522  
Email: DAHN@MOFO.COM

Emily R Whelan  
[COR LD NTC]  
Wilmer Cutler Pickering Hal and Dorr LLP  
60 State Street  
Boston , MA 02109  
USA  
617-526-6567  
Fax:  
<i>pro Hac Vice</ I>  
Email: Emily.whelan@wilmerhale.com

Erik J Olson  
[COR LD NTC]  
Morrison & Foerster LLP  
755 Page Mill Road  
Palo Alto , CA 94304  
USA  
650-813-5600  
Fax: (650) 494-0792  
Email: Ejolson@mofo.com

Esther Kim  
[COR LD NTC]  
Morrison & Foerster LLP  
425 Market Street  
San Francisco , CA 94105  
USA  
(415) 268-7000  
Fax: (415) 268-7522  
Email: EKIM@MOFO.COM

Grant L Kim  
[COR LD NTC]  
Morrison & Foerster LLP  
425 Market Street  
San Francisco , CA 94105  
USA  
415-268-7359  
Fax: 415-268-7522  
Email: Gkim@mofo.com

Harold J McElhinny  
[COR LD NTC]  
Morrison & Foerster LLP

425 Market Street  
San Francisco , CA 94105  
USA  
(415) 268-7265  
Email: Hmcelhinny@mofo.com

James C Burling  
[COR LD NTC]  
60 State Street  
Boston , MA 02109  
USA  
617-526-6416

Jason R Bartlett  
[COR LD NTC]  
Morrison & Foerster LLP  
425 Market Street  
34TH Floor  
San Francisco , CA 94105  
USA  
415-268-6615  
Fax: 415-268-7522  
Email: JASONBARTLETT@MOFO.COM

Jennifer Lee Taylor  
[COR LD NTC]  
Morrison & Foerster LLP  
425 Market St  
San Francisco , CA 94105-2482  
USA  
(415) 268-7000  
Email: Jleetaylor@mofo.com

Jeremy Winer  
[COR LD NTC]  
Wilmer Cutler Pickering Hale and Dorr LLP  
399 Park Avenue  
New York , NY 10022  
USA  
212-230-8800  
<i>pro Hac Vice</ I>

Jesse L Dyer  
[COR LD NTC]  
Cooley  
3175 Hanover Street  
Palo Alto , CA 94304  
USA  
650-843-5000  
Email: JDYER@COOLEY.COM

Joshua Ryan Benson  
[COR LD NTC]  
Taylor and Co Law Offices  
One Ferry Bldg  
Suite No 355  
SF , CA 94111  
USA  
415-788-8200  
Fax: 415-788-8208  
Email: JBENSON@TCOLAW.COM

Kenneth Howard Bridges  
[COR LD NTC]  
Bridges & Mavrakakis LLP  
3000 El Camino Real  
One Palo Alto Square, 2ND Floor

Palo Alto , CA 94306  
USA  
650-804-7804  
Fax: 650-852-9224  
Email: KBRIDGES@BRIDGESMAV.COM

Liv Leila Herriot  
[COR LD NTC]  
Wilmer Cutler Et Al  
950 Page Mill Road  
Palo Alto , CA 94304  
USA  
650-858-6138  
Email: LIV.HERRIOT@WILMERHALE.COM

Mark D Flanagan  
[COR LD NTC]  
Wilmerhale  
950 Page Mill Road  
Palo Alto , CA 94304  
USA  
650-858-6047  
fax: 650-858-6100  
email: Mark.Flanagan@wilmerhale.Com

Mark Daniel Selwyn  
[COR LD NTC]  
Wilmer Cutler Pickering Hale and Dorr LLP  
950 Page Mill Road  
Palo Alto , CA 94304  
USA  
650-858-6031  
Fax: 650-858-6100  
Email: MARK.SELWYN@WILMERHALE.COM

Michael A Diener  
[COR LD NTC]  
Wilmer Cutler Pickering Hale and Dorr LLP  
60 State Street  
Boston , MA 02109  
USA  
617-526-6454  
<i>pro Hac Vice</ I>

Michael Thomas Pieja  
[COR LD NTC]  
Bridges & Mavrakakis LLP  
3000 El Camino Real  
One Palo Alto Square, 2ND Floor  
Palo Alto , CA 94306  
USA  
650-804-7810  
Fax: 650-852-9224  
Email: MPIEJA@BRIDGESMAV.COM

Michael Saji  
[COR LD NTC]  
60 State Street  
Boston , MA 02109  
USA  
617-526-6813  
<i>pro Hac Vice</ I>

Patrick J Zhang  
[COR LD NTC]  
Morrison Foerster  
425 Market St

San Francisco , CA 94105  
USA  
415-268-7653  
Email: PZHANG@MOFO.COM

Peter James Kolovos  
[COR LD NTC]  
Wilmerhale  
60 State St  
Boston , MA 02109  
USA  
(617)526-6000  
Fax:  
<i>pro Hac Vice</ I>  
Email: Peter.kolovos@wilmerhale.com

Richard Goldenberg  
[COR LD NTC]  
Hale & Dorr, LLP  
60 State Street  
Boston , MA 02109-1803  
USA  
(617) 526-6548  
<i>pro Hac Vice</ I>

Richard SJ Hung  
[COR LD NTC]  
Morrison & Foerster LLP  
425 Market Street  
San Francisco , CA 94105  
USA  
(415) 268-7000  
Fax: (415) 268-7522  
Email: RHUNG@MOFO.COM

Robert Donald Cultice  
[COR LD NTC]  
Wilmer Cutler Pickering Hal and Dorr LLP  
60 State Street  
Boston , MA 02109  
USA  
617-526-6021  
Fax:  
<i>pro Hac Vice</ I>  
Email: Robert.cultice@wilmerhale.com

Robert J Gunther , Jr  
[COR LD NTC]  
Wilmer Cutler Pickering Hle and Dorr LLP  
399 Park Avenue  
New York , NY 10022  
USA  
212-230-8800  
<i>pro Hac Vice</ I>

Stephen McGeorge Bundy  
[COR LD NTC]  
Taylor & Company Law Offices, LLP  
One Ferry Building, Suite 355  
San Francisco , CA 94111  
USA  
(415) 788-8200  
Fax: (415) 788-8208  
Email: SBUNDY@TCOLAW.COM

Stephen E Taylor  
[COR LD NTC]



Taylor & Company Law Offices, LLP  
One Ferry Building, Suite 355  
San Francisco , CA 94111  
USA  
415-788-8200  
Fax: 415-788-8208  
Email: STAYLOR@TCOLAW.COM

Timothy S Teter  
[COR LD NTC]  
Cooley LLP  
5 Palo Alto Square  
3000 El Camino Real  
Palo Alto , CA 94306  
USA  
650-843-5000  
Fax: 650-849-7400  
Email: TETER@COOLEY.COM

Victor F Souto  
[COR LD NTC]  
Wilmerhale  
399 Park Avenue  
New York , NY 10022  
USA  
(212) 937-7224  
Email: VIC.SOUTO@WILMERHALE.COM

William F Lee  
[COR LD NTC]  
Wilmer Pickering Hale and Dorr LLP  
60 State Street  
Boston , MA 02109  
USA  
617-526-65560  
Fax: 617-526-5000  
<i>pro Hac Vice</ I>  
Email: WILLIAM.LEE@WILMERHALE.COM

Samsung Electronics Co Ltd A Korean Corporation  
Defendant

Huan-YI Lin  
[COR LD NTC]  
Steptoe Johnson LLP  
2121 Avenue of the Stars, Suite 2800  
Los Angeles , CA 90067  
USA  
310-734-1930  
Fax: 310-734-1931  
<i>pro Hac Vice</ I>  
Email: Hlin@steptoe.com

John M Caracappa  
[COR LD NTC]  
1330 Connecticut Ave, NW  
Washington , DC 20036  
USA  
202-429-3000  
Fax: 202-429-3902  
<i>pro Hac Vice</ I>  
Email: Jcaracap@steptoe.com

Paul A Gennari  
[COR LD NTC]  
Steptoe and Johnson LLP  
1330 Connecticut Ave, NW  
Washington , DC 20036  
USA

202-429-6413  
<i>pro Hac Vice</ I>  
Email: Pgennari@steptoe.com

Thomas G Pasternak  
[COR LD NTC]  
Dla Piper US LLP  
115 South La Salle Street  
Suite 3100  
Chicago , IL 60603  
USA  
(312) 577-1265  
<i>pro Hac Vice</ I>

Benjamin Laban Singer  
[COR LD NTC]  
Hopfenfeld Singer Rice and Saito LLP  
235 Montgomery Street  
Suite 907  
San Francisco , CA 94104  
USA  
(415) 500-6080  
Email: BLS@HSRSLAW.COM

Edward H Rice  
[COR LD NTC]  
Hopfenfeld Singer Rice & Saito LLP  
30 S Wacker Drive  
suite 2200  
Chicago , IL 60606  
USA  
312-953-4566  
<i>pro Hac Vice</ I>

James E Hopfenfeld  
[COR LD NTC]  
Hopfenfeld Singer Rice & Saito  
235 Montgomery Street  
Suite 907  
San Francisco , CA 94104  
USA  
415-500-6077  
Email: JEH@HSRSLAW.COM

Kevin PB Johnson  
[COR LD NTC]  
Quinn Emanuel Urquhart & Sullivan LLP  
555 Twin Dolphin Drive  
5TH Floor  
Redwood Shores , CA 94065  
USA  
650-801-5000  
Fax: 650-801-5100  
Email: KEVINJOHNSON@QUINNEMANUEL.COM

Kfir B Levy  
[COR LD NTC]  
Kellogg, Huber, Hansen, Todd, Evans & Figel, PLLC  
1615 M Street, Nw  
suite 400  
Washington , DC 20036  
USA  
202-326-7900  
fax: 202-326-7999  
email: Klevy@steptoe.Com

Margret Mary Caruso

[COR LD NTC]  
Attorney at Law  
555 Twin Dolphin Drive,  
Suite 560  
Redwood Shores , CA 94065  
USA  
650-801-5000  
Fax: 650-801-5100  
Email: Margretcaruso@quinnemanuel.com

Marina N Saito  
[COR LD NTC]  
Hopenfeld Singer Rice & Saito LLP  
30 S Wacker Drive  
suite 2200  
Chicago , IL 60606  
USA  
312-420-5454  
<i>pro Hac Vice</ i>

Michael Richard Heimbold  
[COR LD NTC]  
Steptoe & Johnson LLP  
2121 Avenue of the Stars  
Suite 2800  
Los Angeles , CA 90067  
USA  
310.734.3200  
Fax: 310.734.3300  
Email: Mheimbold@steptoe.com

Rachel H Kassabian  
[COR LD NTC]  
Quinn Emanuel Urquhart & Sullivan LLP  
555 Twin Dolphin Drive 5TH Floor  
Redwood Shores , CA 94065  
USA  
650-801-5000  
Fax: 650-801-5100  
Email: RACHELKASSABIAN@QUINNEMANUEL.COM

Todd Michael Briggs  
[COR LD NTC]  
Quinn Emanuel Urquhart & Sullivan, LLP  
555 Twin Dolphin Drive, Fifth Floor  
Redwood Shores , CA 94065  
USA  
(650) 801-5000  
Email: TODDBRIGGS@QUINNEMANUEL.COM

Victoria F Maroulis  
[COR LD NTC]  
Quinn Emanuel Urquhart Oliver & Hedges L  
555 Twin Dolphin Drive, Fifth Floor  
Redwood Shores , CA 94065  
USA  
(650) 801-5000  
Fax: (650) 801-5100  
Email: VICTORIAMAROULIS@QUINNEMANUEL.COM

Samsung Electronics America, Inc A New York  
Corporation  
Defendant

Charles Kramer Verhoeven  
[COR LD NTC]  
Quinn Emanuel Urquhart Oliver & Hedges L  
50 California Street, 22ND Floor  
San Francisco , CA 94111  
USA

415-875-6600  
Email: CHARLESVERHOEVEN@QUINNEMANUEL.COM

Huan-YI Lin  
[COR LD NTC]  
Steptoe Johnson LLP  
2121 Avenue of the Stars, Suite 2800  
Los Angeles , CA 90067  
USA  
310-734-1930  
Fax: 310-734-1931  
<i>pro Hac Vice</ I>  
Email: Hlin@steptoe.com

John M Caracappa  
[COR LD NTC]  
1330 Connecticut Ave, NW  
Washington , DC 20036  
USA  
202-429-3000  
Fax: 202-429-3902  
<i>pro Hac Vice</ I>  
Email: Jcaracap@steptoe.com

Paul A Gennari  
[COR LD NTC]  
Steptoe and Johnson LLP  
1330 Connecticut Ave, NW  
Washington , DC 20036  
USA  
202-429-6413  
<i>pro Hac Vice</ I>  
Email: Pgennari@steptoe.com

Thomas G Pasternak  
[COR LD NTC]  
Dla Piper US LLP  
115 South La Salle Street  
Suite 3100  
Chicago , IL 60603  
USA  
(312) 577-1265  
<i>pro Hac Vice</ I>

Benjamin Laban Singer  
[COR LD NTC]  
Hopenfeld Singer Rice and Saito LLP  
235 Montgomery Street  
Suite 907  
San Francisco , CA 94104  
USA  
(415) 500-6080  
Email: BLS@HSRSLAW.COM

Edward John Defranco  
[COR LD NTC]  
Quinn Emanuel Urquhart Sullivan  
51 Madison Avenue, 22TH Floor  
New York , NY 10010  
USA  
212-849-7106  
Fax:  
Email: Eddefranco@quinnemanuel.com

Edward H Rice  
[COR LD NTC]  
Hopenfeld Singer Rice & Saito LLP

30 S Wacker Drive  
suite 2200  
Chicago , IL 60606  
USA  
312-953-4566  
<i>pro Hac Vice</ I>

James E Hopenfeld  
[COR LD NTC]  
Hopenfeld Singer Rice & Saito  
235 Montgomery Street  
Suite 907  
San Francisco , CA 94104  
USA  
415-500-6077  
Email: JEH@HSRSLAW.COM

Kevin PB Johnson  
[COR LD NTC]  
Quinn Emanuel Urquhart & Sullivan LLP  
555 Twin Dolphin Drive  
5TH Floor  
Redwood Shores , CA 94065  
USA  
650-801-5000  
Fax: 650-801-5100  
Email: KEVINJOHNSON@QUINNEMANUEL.COM

Kfir B Levy  
[COR LD NTC]  
Kellogg, Huber, Hansen, Todd, Evans & Figel, PLLC  
1615 M Street, Nw  
suite 400  
Washington , DC 20036  
USA  
202-326-7900  
fax: 202-326-7999  
email: Klevy@steptoe.Com

Margret Mary Caruso  
[COR LD NTC]  
Attorney at Law  
555 Twin Dolphin Drive,  
Suite 560  
Redwood Shores , CA 94065  
USA  
650-801-5000  
Fax: 650-801-5100  
Email: Margretcaruso@quinnemanuel.com

Marina N Saito  
[COR LD NTC]  
Hopenfeld Singer Rice & Saito LLP  
30 S Wacker Drive  
suite 2200  
Chicago , IL 60606  
USA  
312-420-5454  
<i>pro Hac Vice</ I>

Michael Richard Heimbald  
[COR LD NTC]  
Steptoe & Johnson LLP  
2121 Avenue of the Stars  
Suite 2800  
Los Angeles , CA 90067  
USA

310.734.3200  
Fax: 310.734.3300  
Email: Mheimbold@steptoe.com

Michael Thomas Zeller  
[COR LD NTC]  
865 S Figueroa Street  
10TH Floor  
Los Angeles , CA 90017  
USA  
213-443-3000  
Fax: 213-443-3100

Rachel H Kassabian  
[COR LD NTC]  
Quinn Emanuel Urquhart & Sullivan LLP  
555 Twin Dolphin Drive 5TH Floor  
Redwood Shores , CA 94065  
USA  
650-801-5000  
Fax: 650-801-5100  
Email: RACHELKASSABIAN@QUINNEMANUEL.COM

Todd Michael Briggs  
[COR LD NTC]  
Quinn Emanuel Urquhart & Sullivan, LLP  
555 Twin Dolphin Drive, Fifth Floor  
Redwood Shores , CA 94065  
USA  
(650) 801-5000  
Email: TODDBRIGGS@QUINNEMANUEL.COM

Victoria F Maroulis  
[COR LD NTC]  
Quinn Emanuel Urquhart Oliver & Hedges L  
555 Twin Dolphin Drive, Fifth Floor  
Redwood Shores , CA 94065  
USA  
(650) 801-5000  
Fax: (650) 801-5100  
Email: VICTORIAMAROULIS@QUINNEMANUEL.COM

Samsung Telecommunications America, Lic A Delaware  
Limited Liability Company  
Defendant

Charles Kramer Verhoeven  
[COR LD NTC]  
Quinn Emanuel Urquhart Oliver & Hedges L  
50 California Street, 22ND Floor  
San Francisco , CA 94111  
USA  
415-875-6600  
Email: CHARLESVERHOEVEN@QUINNEMANUEL.COM

Huan-YI Lin  
[COR LD NTC]  
Steptoe Johnson LLP  
2121 Avenue of the Stars, Suite 2800  
Los Angeles , CA 90067  
USA  
310-734-1930  
Fax: 310-734-1931  
<i>pro Hac Vice</ i>  
Email: Hlin@steptoe.com

John M Caracappa  
[COR LD NTC]  
1330 Connecticut Ave, NW  
Washington , DC 20036

USA  
202-429-3000  
Fax: 202-429-3902  
<i>pro Hac Vice</ I>  
Email: Jcaracap@steptoe.com

Paul A Gennari  
[COR LD NTC]  
Steptoe and Johnson LLP  
1330 Connecticut Ave, NW  
Washington , DC 20036  
USA  
202-429-6413  
<i>pro Hac Vice</ I>  
Email: Pgennari@steptoe.com

Thomas G Pasternak  
[COR LD NTC]  
Dla Piper US LLP  
115 South La Salle Street  
Suite 3100  
Chicago , IL 60603  
USA  
(312) 577-1265  
<i>pro Hac Vice</ I>

Benjamin Laban Singer  
[COR LD NTC]  
Hopenfeld Singer Rice and Saito LLP  
235 Montgomery Street  
Suite 907  
San Francisco , CA 94104  
USA  
(415) 500-6080  
Email: BLS@HSRSLAW.COM

Edward John Defranco  
[COR LD NTC]  
Quinn Emanuel Urquhart Sullivan  
51 Madison Avenue, 22TH Floor  
New York , NY 10010  
USA  
212-849-7106  
Fax:  
Email: Eddefranco@quinnemanuel.com

Edward H Rice  
[COR LD NTC]  
Hopenfeld Singer Rice & Saito LLP  
30 S Wacker Drive  
suite 2200  
Chicago , IL 60606  
USA  
312-953-4566  
<i>pro Hac Vice</ I>

James E Hopenfeld  
[COR LD NTC]  
Hopenfeld Singer Rice & Saito  
235 Montgomery Street  
Suite 907  
San Francisco , CA 94104  
USA  
415-500-6077  
Email: JEH@HSRSLAW.COM

Kevin PB Johnson

[COR LD NTC]  
Quinn Emanuel Urquhart & Sullivan LLP  
555 Twin Dolphin Drive  
5TH Floor  
Redwood Shores , CA 94065  
USA  
650-801-5000  
Fax: 650-801-5100  
Email: KEVINJOHNSON@QUINNEMANUEL.COM

Kfir B Levy  
[COR LD NTC]  
Kellogg, Huber, Hansen, Todd, Evans & Figel, PLLC  
1615 M Street, Nw  
suite 400  
Washington , DC 20036  
USA  
202-326-7900  
fax: 202-326-7999  
email: Klevy@steptoe.Com

Margret Mary Caruso  
[COR LD NTC]  
Attorney at Law  
555 Twin Dolphin Drive,  
Suite 560  
Redwood Shores , CA 94065  
USA  
650-801-5000  
Fax: 650-801-5100  
Email: Margretcaruso@quinnemanuel.com

Marina N Saito  
[COR LD NTC]  
Hopenfeld Singer Rice & Saito LLP  
30 S Wacker Drive  
suite 2200  
Chicago , IL 60606  
USA  
312-420-5454  
<i>pro Hac Vice</ I>

Michael Richard Heimbold  
[COR LD NTC]  
Steptoe & Johnson LLP  
2121 Avenue of the Stars  
Suite 2800  
Los Angeles , CA 90067  
USA  
310.734.3200  
Fax: 310.734.3300  
Email: Mheimbold@steptoe.com

Michael Thomas Zeller  
[COR LD NTC]  
865 S Figueroa Street  
10TH Floor  
Los Angeles , CA 90017  
USA  
213-443-3000  
Fax: 213-443-3100

Rachel H Kassabian  
[COR LD NTC]  
Quinn Emanuel Urquhart & Sullivan LLP  
555 Twin Dolphin Drive 5TH Floor  
Redwood Shores , CA 94065



USA  
650-801-5000  
Fax: 650-801-5100  
Email: RACHELKASSABIAN@QUINNEMANUEL.COM

Todd Michael Briggs  
[COR LD NTC]  
Quinn Emanuel Urquhart & Sullivan, LLP  
555 Twin Dolphin Drive, Fifth Floor  
Redwood Shores , CA 94065  
USA  
(650) 801-5000  
Email: TODDBRIGGS@QUINNEMANUEL.COM

Victoria F Maroulis  
[COR LD NTC]  
Quinn Emanuel Urquhart Oliver & Hedges L  
555 Twin Dolphin Drive, Fifth Floor  
Redwood Shores , CA 94065  
USA  
(650) 801-5000  
Fax: (650) 801-5100  
Email: VICTORIAMAROULIS@QUINNEMANUEL.COM

Cellco Partnership DbA Verizon Wireless  
Amicus

Melinda Mae Morton  
[COR LD NTC]  
Bergeson, LLP  
303 Almaden Blvd, Suite 500  
San Jose , CA 95110-2712  
USA  
408-291-6203  
Fax: (408) 297-6000  
Email: MMORTON@BE-Law.com

T-Mobile USA, Inc  
Amicus

Michael J Bettinger  
[COR LD NTC]  
K&L Gates LLP  
Four Embarcadero Center, Suite 1200  
San Francisco , CA 94111  
USA  
415-882-8200  
Fax: 415-882-8220  
Email: MIKE.BETTINGER@KLGATES.COM

Samsung Telecommunications America, Llc A Delaware  
Limited Liability Company  
Counter-Claimant

Charles Kramer Verhoeven  
[COR LD NTC]  
Quinn Emanuel Urquhart Oliver & Hedges L  
50 California Street, 22ND Floor  
San Francisco , CA 94111  
USA  
415-875-6600  
Email: CHARLESVERHOEVEN@QUINNEMANUEL.COM

Huan-YI Lin  
[COR LD NTC]  
Steptoe Johnson LLP  
2121 Avenue of the Stars, Suite 2800  
Los Angeles , CA 90067  
USA  
310-734-1930  
Fax: 310-734-1931  
<I>pro Hac Vice</ I>  
Email: Hlin@steptoe.com

John M Caracappa  
[COR LD NTC]  
1330 Connecticut Ave, NW  
Washington , DC 20036  
USA  
202-429-3000  
Fax: 202-429-3902  
<i>pro Hac Vice</ I>  
Email: Jcaracap@steptoe.com

Thomas G Pasternak  
[COR LD NTC]  
Dla Piper US LLP  
115 South La Salle Street  
Suite 3100  
Chicago , IL 60603  
USA  
(312) 577-1265  
<i>pro Hac Vice</ I>

Edward John Defranco  
[COR LD NTC]  
Quinn Emanuel Urquhart Sullivan  
51 Madison Avenue, 22TH Floor  
New York , NY 10010  
USA  
212-849-7106  
Fax:  
Email: Eddefranco@quinnemanuel.com

Edward H Rice  
[COR LD NTC]  
Hopenfeld Singer Rice & Saito LLP  
30 S Wacker Drive  
suite 2200  
Chicago , IL 60606  
USA  
312-953-4566  
<i>pro Hac Vice</ I>

Kevin PB Johnson  
[COR LD NTC]  
Quinn Emanuel Urquhart & Sullivan LLP  
555 Twin Dolphin Drive  
5TH Floor  
Redwood Shores , CA 94065  
USA  
650-801-5000  
Fax: 650-801-5100  
Email: KEVINJOHNSON@QUINNEMANUEL.COM

Kfir B Levy  
[COR LD NTC]  
Kellogg, Huber, Hansen, Todd, Evans & Figel, PLLC  
1615 M Street, Nw  
suite 400  
Washington , DC 20036  
USA  
202-326-7900  
fax: 202-326-7999  
email: Klevy@steptoe.Com

Margret Mary Caruso  
[COR LD NTC]  
Attorney at Law  
555 Twin Dolphin Drive,  
Suite 560

Redwood Shores , CA 94065  
USA  
650-801-5000  
Fax: 650-801-5100  
Email: Margretcaruso@quinnemanuel.com

Marina N Saito  
[COR LD NTC]  
Hopenfeld Singer Rice & Saito LLP  
30 S Wacker Drive  
suite 2200  
Chicago , IL 60606  
USA  
312-420-5454  
<i>pro Hac Vice</ I>

Michael Richard Heimbold  
[COR LD NTC]  
Steptoe & Johnson LLP  
2121 Avenue of the Stars  
Suite 2800  
Los Angeles , CA 90067  
USA  
310.734.3200  
Fax: 310.734.3300  
Email: Mheimbold@steptoe.com

Michael Thomas Zeller  
[COR LD NTC]  
865 S Figueroa Street  
10TH Floor  
Los Angeles , CA 90017  
USA  
213-443-3000  
Fax: 213-443-3100

Rachel H Kassabian  
[COR LD NTC]  
Quinn Emanuel Urquhart & Sullivan LLP  
555 Twin Dolphin Drive 5TH Floor  
Redwood Shores , CA 94065  
USA  
650-801-5000  
Fax: 650-801-5100  
Email: RACHELKASSABIAN@QUINNEMANUEL.COM

Todd Michael Briggs  
[COR LD NTC]  
Quinn Emanuel Urquhart & Sullivan, LLP  
555 Twin Dolphin Drive, Fifth Floor  
Redwood Shores , CA 94065  
USA  
(650) 801-5000  
Email: TODDBRIGGS@QUINNEMANUEL.COM

Victoria F Maroulis  
[COR LD NTC]  
Quinn Emanuel Urquhart Oliver & Hedges L  
555 Twin Dolphin Drive, Fifth Floor  
Redwood Shores , CA 94065  
USA  
(650) 801-5000  
Fax: (650) 801-5100  
Email: VICTORIAMAROULIS@QUINNEMANUEL.COM

Samsung Electronics America, Inc A New York

Charles Kramer Verhoeven

Corporation  
Counter-Claimant

[COR LD NTC]  
Quinn Emanuel Urquhart Oliver & Hedges L  
50 California Street, 22ND Floor  
San Francisco , CA 94111  
USA  
415-875-6600  
Email: CHARLESVERHOEVEN@QUINNEMANUEL.COM

Huan-YI Lin  
[COR LD NTC]  
Steptoe Johnson LLP  
2121 Avenue of the Stars, Suite 2800  
Los Angeles , CA 90067  
USA  
310-734-1930  
Fax: 310-734-1931  
<i>pro Hac Vice</ I>  
Email: Hlin@steptoe.com

John M Caracappa  
[COR LD NTC]  
1330 Connecticut Ave, NW  
Washington , DC 20036  
USA  
202-429-3000  
Fax: 202-429-3902  
<i>pro Hac Vice</ I>  
Email: Jcaracap@steptoe.com

Thomas G Pasternak  
[COR LD NTC]  
Dla Piper US LLP  
115 South La Salle Street  
Suite 3100  
Chicago , IL 60603  
USA  
(312) 577-1265  
<i>pro Hac Vice</ I>

Edward John Defranco  
[COR LD NTC]  
Quinn Emanuel Urquhart Sullivan  
51 Madison Avenue, 22TH Floor  
New York , NY 10010  
USA  
212-849-7106  
Fax:  
Email: Eddefranco@quinnemanuel.com

Edward H Rice  
[COR LD NTC]  
Hopenfeld Singer Rice & Saito LLP  
30 S Wacker Drive  
suite 2200  
Chicago , IL 60606  
USA  
312-953-4566  
<i>pro Hac Vice</ I>

Kevin PB Johnson  
[COR LD NTC]  
Quinn Emanuel Urquhart & Sullivan LLP  
555 Twin Dolphin Drive  
5TH Floor  
Redwood Shores , CA 94065  
USA  
650-801-5000

Fax: 650-801-5100  
Email: KEVINJOHNSON@QUINNEMANUEL.COM

Kfir B Levy  
[COR LD NTC]  
Kellogg, Huber, Hansen, Todd, Evans & Figel, PLLC  
1615 M Street, Nw  
suite 400  
Washington , DC 20036  
USA  
202-326-7900  
fax: 202-326-7999  
email: Klevy@steptoe.Com

Margret Mary Caruso  
[COR LD NTC]  
Attorney at Law  
555 Twin Dolphin Drive,  
Suite 560  
Redwood Shores , CA 94065  
USA  
650-801-5000  
Fax: 650-801-5100  
Email: Margretcaruso@quinnemanuel.com

Marina N Saito  
[COR LD NTC]  
Hopenfeld Singer Rice & Saito LLP  
30 S Wacker Drive  
suite 2200  
Chicago , IL 60606  
USA  
312-420-5454  
<i>pro Hac Vice</ I>

Michael Richard Heimbold  
[COR LD NTC]  
Steptoe & Johnson LLP  
2121 Avenue of the Stars  
Suite 2800  
Los Angeles , CA 90067  
USA  
310.734.3200  
Fax: 310.734.3300  
Email: Mheimbold@steptoe.com

Michael Thomas Zeller  
[COR LD NTC]  
865 S Figueroa Street  
10TH Floor  
Los Angeles , CA 90017  
USA  
213-443-3000  
Fax: 213-443-3100

Rachel H Kassabian  
[COR LD NTC]  
Quinn Emanuel Urquhart & Sullivan LLP  
555 Twin Dolphin Drive 5TH Floor  
Redwood Shores , CA 94065  
USA  
650-801-5000  
Fax: 650-801-5100  
Email: RACHELKASSABIAN@QUINNEMANUEL.COM

Todd Michael Briggs  
[COR LD NTC]

Quinn Emanuel Urquhart & Sullivan, LLP  
555 Twin Dolphin Drive, Fifth Floor  
Redwood Shores , CA 94065  
USA  
(650) 801-5000  
Email: TODDBRIGGS@QUINNEMANUEL.COM

Victoria F Maroulis  
[COR LD NTC]  
Quinn Emanuel Urquhart Oliver & Hedges L  
555 Twin Dolphin Drive, Fifth Floor  
Redwood Shores , CA 94065  
USA  
(650) 801-5000  
Fax: (650) 801-5100  
Email: VICTORIAMAROULIS@QUINNEMANUEL.COM

Samsung Electronics Co Ltd A Korean Corporation  
Counter-Claimant

Huan-YI Lin  
[COR LD NTC]  
Steptoe Johnson LLP  
2121 Avenue of the Stars, Suite 2800  
Los Angeles , CA 90067  
USA  
310-734-1930  
Fax: 310-734-1931  
<i>pro Hac Vice</ I>  
Email: Hlin@steptoe.com

John M Caracappa  
[COR LD NTC]  
1330 Connecticut Ave, NW  
Washington , DC 20036  
USA  
202-429-3000  
Fax: 202-429-3902  
<i>pro Hac Vice</ I>  
Email: Jcaracap@steptoe.com

Thomas G Pasternak  
[COR LD NTC]  
Dla Piper US LLP  
115 South La Salle Street  
Suite 3100  
Chicago , IL 60603  
USA  
(312) 577-1265  
<i>pro Hac Vice</ I>

Edward H Rice  
[COR LD NTC]  
Hopenfeld Singer Rice & Saito LLP  
30 S Wacker Drive  
suite 2200  
Chicago , IL 60606  
USA  
312-953-4566  
<i>pro Hac Vice</ I>

Kfir B Levy  
[COR LD NTC]  
Kellogg, Huber, Hansen, Todd, Evans & Figel, PLLC  
1615 M Street, Nw  
suite 400  
Washington , DC 20036  
USA  
202-326-7900

fax: 202-326-7999  
email: Klevy@steptoe.Com

Margret Mary Caruso  
[COR LD NTC]  
Attorney at Law  
555 Twin Dolphin Drive,  
Suite 560  
Redwood Shores , CA 94065  
USA  
650-801-5000  
Fax: 650-801-5100  
Email: Margretcaruso@quinnemanuel.com

Marina N Saito  
[COR LD NTC]  
Hopenfeld Singer Rice & Saito LLP  
30 S Wacker Drive  
suite 2200  
Chicago , IL 60606  
USA  
312-420-5454  
<i>pro Hac Vice</ I>

Michael Richard Heimbold  
[COR LD NTC]  
Steptoe & Johnson LLP  
2121 Avenue of the Stars  
Suite 2800  
Los Angeles , CA 90067  
USA  
310.734.3200  
Fax: 310.734.3300  
Email: Mheimbold@steptoe.com

Rachel H Kassabian  
[COR LD NTC]  
Quinn Emanuel Urquhart & Sullivan LLP  
555 Twin Dolphin Drive 5TH Floor  
Redwood Shores , CA 94065  
USA  
650-801-5000  
Fax: 650-801-5100  
Email: RACHELKASSABIAN@QUINNEMANUEL.COM

Todd Michael Briggs  
[COR LD NTC]  
Quinn Emanuel Urquhart & Sullivan, LLP  
555 Twin Dolphin Drive, Fifth Floor  
Redwood Shores , CA 94065  
USA  
(650) 801-5000  
Email: TODDBRIGGS@QUINNEMANUEL.COM

Victoria F Maroulis  
[COR LD NTC]  
Quinn Emanuel Urquhart Oliver & Hedges L  
555 Twin Dolphin Drive, Fifth Floor  
Redwood Shores , CA 94065  
USA  
(650) 801-5000  
Fax: (650) 801-5100  
Email: VICTORIAMAROULIS@QUINNEMANUEL.COM

Apple Inc A California Corporation  
Counter-Defendant

Michael A Jacobs  
[COR LD NTC]

Morrison & Foerster LLP  
425 Market Street  
San Francisco , CA 94105  
USA  
(415) 268-7455  
Fax: (415) 268-7522  
Email: Mjacobs@mofo.com

Samuel Calvin Walden  
[COR LD NTC]  
Wilmer Cutler Pickering Hale and Dorr LLP  
399 Park Avenue  
New York , NY 10022  
USA  
212-230-8800  
<i>pro Hac Vice</ I>

Timonhy D Syrett  
[COR LD NTC]  
60 State Street  
Boston , MA 02109  
USA  
617-526-6975  
<i>pro Hac Vice</ I>

Ali H Shah  
[COR LD NTC]  
Wilmer Cutler Pickering Hale and Dorr LLP  
1875 Pennsylvania Avenue NW  
Washington , DC 20006  
USA  
202-663-6064  
Fax: 202-663-6363  
<i>pro Hac Vice</ I>  
Email: Ali.shah@wilmerhale.com

Alison Margaret Tucher  
[COR LD NTC]  
Morrison & Foerster LLP  
425 Market Street  
San Francisco , CA 94105  
USA  
415-268-7269  
Email: ATUCHER@MOFO.COM

Benjamin George Damstedt  
[COR LD NTC]  
Cooley Godward Kronish LLP  
Five Palo Alto Square  
3000 El Camino Real  
Palo Alto , CA 94306  
USA  
650-843-5000  
Fax: 650-857-0663  
Email: BDAMSTEDT@COOLEY.COM

Brian Larivee  
[COR LD NTC]  
Wilmer Cutler Pickering Hall and Dorr LLP  
60 State Street  
Boston , MA 02109  
USA  
617-526-6226  
<i>pro Hac Vice</ I>

Brian Seeve  
[COR LD NTC]



60 State Street  
Boston , MA 02109  
USA  
617-526-6160  
<i>pro Hac Vice</ I>

Christine E Duh  
[COR LD NTC]  
Wilmer Hale  
950 Page Mill Road  
Palo Alto , CA 94304  
USA  
650-858-6051  
Fax: 650-858-6000  
Email: CHRISTINE.DUH@WILMERHALE.COM

David B Bassett  
[COR LD NTC]  
Wilmercutler Pickering Hall and Dorr LLP  
399 Park Avenue  
New York , NY 10022  
USA  
(212) 230-8800  
Fax: (212) 230-8888  
<i>pro Hac Vice</ I>  
Email: DAVID.BASSETT@WILMERHALE.COM

Deok Keun Matthew AHN  
[COR LD NTC]  
Morrison & Foerster  
425 Market Street  
San Francisco , CA 94105  
USA  
415-268-6629  
Fax: 415-268-7522  
Email: DAHN@MOFO.COM

Emily R Whelan  
[COR LD NTC]  
Wilmer Cutler Pickering Hal and Dorr LLP  
60 State Street  
Boston , MA 02109  
USA  
617-526-6567  
Fax:  
<i>pro Hac Vice</ I>  
Email: Emily.whelan@wilmerhale.com

Erik J Olson  
[COR LD NTC]  
Morrison & Foerster LLP  
755 Page Mill Road  
Palo Alto , CA 94304  
USA  
650-813-5600  
Fax: (650) 494-0792  
Email: Ejolson@mofo.com

Esther Kim  
[COR LD NTC]  
Morrison & Foerster LLP  
425 Market Street  
San Francisco , CA 94105  
USA  
(415) 268-7000  
Fax: (415) 268-7522  
Email: EKIM@MOFO.COM

Grant L Kim  
[COR LD NTC]  
Morrison & Foerster LLP  
425 Market Street  
San Francisco , CA 94105  
USA  
415-268-7359  
Fax: 415-268-7522  
Email: Gkim@mofocom

Harold J McElhinny  
[COR LD NTC]  
Morrison & Foerster LLP  
425 Market Street  
San Francisco , CA 94105  
USA  
(415) 268-7265  
Email: Hmcelhinny@mofocom

James C Burling  
[COR LD NTC]  
60 State Street  
Boston , MA 02109  
USA  
617-526-6416

Jason R Bartlett  
[COR LD NTC]  
Morrison & Foerster LLP  
425 Market Street  
34TH Floor  
San Francisco , CA 94105  
USA  
415-268-6615  
Fax: 415-268-7522  
Email: JASONBARTLETT@MOFO.COM

Jennifer Lee Taylor  
[COR LD NTC]  
Morrison & Foerster LLP  
425 Market St  
San Francisco , CA 94105-2482  
USA  
(415) 268-7000  
Email: Jleetaylor@mofocom

Jeremy Winer  
[COR LD NTC]  
Wilmer Cutler Pickering Hale and Dorr LLP  
399 Park Avenue  
New York , NY 10022  
USA  
212-230-8800  
<i>pro Hac Vice</ I>

Jesse L Dyer  
[COR LD NTC]  
Cooley  
3175 Hanover Street  
Palo Alto , CA 94304  
USA  
650-843-5000  
Email: JDYER@COOLEY.COM

Kenneth Howard Bridges  
[COR LD NTC]

Bridges & Mavrakakis LLP  
3000 El Camino Real  
One Palo Alto Square, 2ND Floor  
Palo Alto , CA 94306  
USA  
650-804-7804  
Fax: 650-852-9224  
Email: KBRIDGES@BRIDGESMAV.COM

Mark D Flanagan  
[COR LD NTC]  
Wilmerhale  
950 Page Mill Road  
Palo Alto , CA 94304  
USA  
650-858-6047  
fax: 650-858-6100  
email: Mark.Flanagan@wilmerhale.Com

Mark Daniel Selwyn  
[COR LD NTC]  
Wilmer Cutler Pickering Hale and Dorr LLP  
950 Page Mill Road  
Palo Alto , CA 94304  
USA  
650-858-6031  
Fax: 650-858-6100  
Email: MARK.SELWYN@WILMERHALE.COM

Michael A Diener  
[COR LD NTC]  
Wilmer Cutler Pickering Hale and Dorr LLP  
60 State Street  
Boston , MA 02109  
USA  
617-526-6454  
<i>pro Hac Vice</ I>

Michael Thomas Pieja  
[COR LD NTC]  
Bridges & Mavrakakis LLP  
3000 El Camino Real  
One Palo Alto Square, 2ND Floor  
Palo Alto , CA 94306  
USA  
650-804-7810  
Fax: 650-852-9224  
Email: MPIEJA@BRIDGESMAV.COM

Michael Saji  
[COR LD NTC]  
60 State Street  
Boston , MA 02109  
USA  
617-526-6813  
<i>pro Hac Vice</ I>

Patrick J Zhang  
[COR LD NTC]  
Morrison Foerster  
425 Market St  
San Francisco , CA 94105  
USA  
415-268-7653  
Email: PZHANG@MOFO.COM

Peter James Kolovos

[COR LD NTC]  
Wilmerhale  
60 State St  
Boston , MA 02109  
USA  
(617)526-6000  
Fax:  
<i>pro Hac Vice</ I>  
Email: Peter.kolovos@wilmerhale.com

Richard Goldenberg  
[COR LD NTC]  
Hale & Dorr, LLP  
60 State Street  
Boston , MA 02109-1803  
USA  
(617) 526-6548  
<i>pro Hac Vice</ I>

Richard SJ Hung  
[COR LD NTC]  
Morrison & Foerster LLP  
425 Market Street  
San Francisco , CA 94105  
USA  
(415) 268-7000  
Fax: (415) 268-7522  
Email: RHUNG@MOFO.COM

Robert Donald Cultice  
[COR LD NTC]  
Wilmer Cutler Pickering Hal and Dorr LLP  
60 State Street  
Boston , MA 02109  
USA  
617-526-6021  
Fax:  
<i>pro Hac Vice</ I>  
Email: Robert.cultice@wilmerhale.com

Robert J Gunther , Jr  
[COR LD NTC]  
Wilmer Cutler Pickering Hle and Dorr LLP  
399 Park Avenue  
New York , NY 10022  
USA  
212-230-8800  
<i>pro Hac Vice</ I>

Timothy S Teter  
[COR LD NTC]  
Cooley LLP  
5 Palo Alto Square  
3000 El Camino Real  
Palo Alto , CA 94306  
USA  
650-843-5000  
Fax: 650-849-7400  
Email: TETERTS@COOLEY.COM

Victor F Souto  
[COR LD NTC]  
Wilmerhale  
399 Park Avenue  
New York , NY 10022  
USA  
(212) 937-7224

Email: VIC.SOUTO@WILMERHALE.COM

William F Lee  
[COR LD NTC]  
Wilmer Pickering Hale and Dorr LLP  
60 State Street  
Boston , MA 02109  
USA  
617-526-65560  
Fax: 617-526-5000  
<i>pro Hac Vice</ I>  
Email: WILLIAM.LEE@WILMERHALE.COM

Apple Inc A California Corporation  
Counter-Claimant

Michael A Jacobs  
[COR LD NTC]  
Morrison & Foerster LLP  
425 Market Street  
San Francisco , CA 94105  
USA  
(415) 268-7455  
Fax: (415) 268-7522  
Email: Mjacobs@mofo.com

Samuel Calvin Walden  
[COR LD NTC]  
Wilmer Cutler Pickering Hale and Dorr LLP  
399 Park Avenue  
New York , NY 10022  
USA  
212-230-8800  
<i>pro Hac Vice</ I>

Timonhy D Syrett  
[COR LD NTC]  
60 State Street  
Boston , MA 02109  
USA  
617-526-6975  
<i>pro Hac Vice</ I>

Ali H Shah  
[COR LD NTC]  
Wilmer Cutler Pickering Hale and Dorr LLP  
1875 Pennsylvania Avenue NW  
Washington , DC 20006  
USA  
202-663-6064  
Fax: 202-663-6363  
<i>pro Hac Vice</ I>  
Email: Ali.shah@wilmerhale.com

Alison Margaret Tucher  
[COR LD NTC]  
Morrison & Foerster LLP  
425 Market Street  
San Francisco , CA 94105  
USA  
415-268-7269  
Email: ATUCHER@MOFO.COM

Benjamin George Damstedt  
[COR LD NTC]  
Cooley Godward Kronish LLP  
Five Palo Alto Square  
3000 El Camino Real  
Palo Alto , CA 94306

USA  
650-843-5000  
Fax: 650-857-0663  
Email: BDAMSTEDT@COOLEY.COM

Brian Larivee  
[COR LD NTC]  
Wilmer Cutler Pickering Hall and Dorr LLP  
60 State Street  
Boston , MA 02109  
USA  
617-526-6226  
<i>pro Hac Vice</ I>

Brian Seeve  
[COR LD NTC]  
60 State Street  
Boston , MA 02109  
USA  
617-526-6160  
<i>pro Hac Vice</ I>

Christine E Duh  
[COR LD NTC]  
Wilmer Hale  
950 Page Mill Road  
Palo Alto , CA 94304  
USA  
650-858-6051  
Fax: 650-858-6100  
Email: CHRISTINE.DUH@WILMERHALE.COM

David B Bassett  
[COR LD NTC]  
Wilmercutler Pickering Hall and Dorr LLP  
399 Park Avenue  
New York , NY 10022  
USA  
(212) 230-8800  
Fax: (212) 230-8888  
<i>pro Hac Vice</ I>  
Email: DAVID.BASSETT@WILMERHALE.COM

Deok Keun Matthew AHN  
[COR LD NTC]  
Morrison & Foerster  
425 Market Street  
San Francisco , CA 94105  
USA  
415-268-6629  
Fax: 415-268-7522  
Email: DAHN@MOFO.COM

Emily R Whelan  
[COR LD NTC]  
Wilmer Cutler Pickering Hal and Dorr LLP  
60 State Street  
Boston , MA 02109  
USA  
617-526-6567  
Fax:  
<i>pro Hac Vice</ I>  
Email: Emily.whelan@wilmerhale.com

Esther Kim  
[COR LD NTC]  
Morrison & Foerster LLP

425 Market Street  
San Francisco , CA 94105  
USA  
(415) 268-7000  
Fax: (415) 268-7522  
Email: EKIM@MOFO.COM

Grant L Kim  
[COR LD NTC]  
Morrison & Foerster LLP  
425 Market Street  
San Francisco , CA 94105  
USA  
415-268-7359  
Fax: 415-268-7522  
Email: Gkim@mofo.com

Harold J McElhinny  
[COR LD NTC]  
Morrison & Foerster LLP  
425 Market Street  
San Francisco , CA 94105  
USA  
(415) 268-7265  
Email: Hmcelhinny@mofo.com

James C Burling  
[COR LD NTC]  
60 State Street  
Boston , MA 02109  
USA  
617-526-6416

Jason R Bartlett  
[COR LD NTC]  
Morrison & Foerster LLP  
425 Market Street  
34TH Floor  
San Francisco , CA 94105  
USA  
415-268-6615  
Fax: 415-268-7522  
Email: JASONBARTLETT@MOFO.COM

Jennifer Lee Taylor  
[COR LD NTC]  
Morrison & Foerster LLP  
425 Market St  
San Francisco , CA 94105-2482  
USA  
(415) 268-7000  
Email: Jleetaylor@mofo.com

Jeremy Winer  
[COR LD NTC]  
Wilmer Cutler Pickering Hale and Dorr LLP  
399 Park Avenue  
New York , NY 10022  
USA  
212-230-8800  
<i>pro Hac Vice</ i>

Jesse L Dyer  
[COR LD NTC]  
Cooley  
3175 Hanover Street  
Palo Alto , CA 94304

USA  
650-843-5000  
Email: JDYER@COOLEY.COM

Kenneth Howard Bridges  
[COR LD NTC]  
Bridges & Mavrakakis LLP  
3000 El Camino Real  
One Palo Alto Square, 2ND Floor  
Palo Alto , CA 94306  
USA  
650-804-7804  
Fax: 650-852-9224  
Email: KBRIDGES@BRIDGESMAV.COM

Mark Daniel Selwyn  
[COR LD NTC]  
Wilmer Cutler Pickering Hale and Dorr LLP  
950 Page Mill Road  
Palo Alto , CA 94304  
USA  
650-858-6031  
Fax: 650-858-6100  
Email: MARK.SELWYN@WILMERHALE.COM

Michael A Diener  
[COR LD NTC]  
Wilmer Cutler Pickering Hale and Dorr LLP  
60 State Street  
Boston , MA 02109  
USA  
617-526-6454  
<i>pro Hac Vice</ I>

Michael Thomas Pieja  
[COR LD NTC]  
Bridges & Mavrakakis LLP  
3000 El Camino Real  
One Palo Alto Square, 2ND Floor  
Palo Alto , CA 94306  
USA  
650-804-7810  
Fax: 650-852-9224  
Email: MPIEJA@BRIDGESMAV.COM

Michael Saji  
[COR LD NTC]  
60 State Street  
Boston , MA 02109  
USA  
617-526-6813  
<i>pro Hac Vice</ I>

Patrick J Zhang  
[COR LD NTC]  
Morrison Foerster  
425 Market St  
San Francisco , CA 94105  
USA  
415-268-7653  
Email: PZHANG@MOFO.COM

Peter James Kolovos  
[COR LD NTC]  
Wilmerhale  
60 State St  
Boston , MA 02109



USA  
(617)526-6000  
Fax:  
<i>pro Hac Vice</ I>  
Email: Peter.kolovos@wilmerhale.com

Richard Goldenberg  
[COR LD NTC]  
Hale & Dorr, LLP  
60 State Street  
Boston , MA 02109-1803  
USA  
(617) 526-6548  
<i>pro Hac Vice</ I>

Robert Donald Cultice  
[COR LD NTC]  
Wilmer Cutler Pickering Hal and Dorr LLP  
60 State Street  
Boston , MA 02109  
USA  
617-526-6021  
Fax:  
<i>pro Hac Vice</ I>  
Email: Robert.cultice@wilmerhale.com

Robert J Gunther , Jr  
[COR LD NTC]  
Wilmer Cutler Pickering Hle and Dorr LLP  
399 Park Avenue  
New York , NY 10022  
USA  
212-230-8800  
<i>pro Hac Vice</ I>

Timothy S Teter  
[COR LD NTC]  
Cooley LLP  
5 Palo Alto Square  
3000 El Camino Real  
Palo Alto , CA 94306  
USA  
650-843-5000  
Fax: 650-849-7400  
Email: TETERTS@COOLEY.COM

Victor F Souto  
[COR LD NTC]  
Wilmerhale  
399 Park Avenue  
New York , NY 10022  
USA  
(212) 937-7224  
Email: VIC.SOUTO@WILMERHALE.COM

William F Lee  
[COR LD NTC]  
Wilmer Pickering Hale and Dorr LLP  
60 State Street  
Boston , MA 02109  
USA  
617-526-65560  
Fax: 617-526-5000  
<i>pro Hac Vice</ I>  
Email: WILLIAM.LEE@WILMERHALE.COM

Samsung Electronics America, Inc A New York

Corporation  
Counter-Defendant

Charles Kramer Verhoeven  
[COR LD NTC]  
Quinn Emanuel Urquhart Oliver & Hedges L  
50 California Street, 22ND Floor  
San Francisco , CA 94111  
USA  
415-875-6600  
Email: CHARLESVERHOEVEN@QUINNEMANUEL.COM

Huan-YI Lin  
[COR LD NTC]  
Steptoe Johnson LLP  
2121 Avenue of the Stars, Suite 2800  
Los Angeles , CA 90067  
USA  
310-734-1930  
Fax: 310-734-1931  
<i>pro Hac Vice</ I>  
Email: Hlin@steptoe.com

John M Caracappa  
[COR LD NTC]  
1330 Connecticut Ave, NW  
Washington , DC 20036  
USA  
202-429-3000  
Fax: 202-429-3902  
<i>pro Hac Vice</ I>  
Email: Jcaracap@steptoe.com

Thomas G Pasternak  
[COR LD NTC]  
Dla Piper US LLP  
115 South La Salle Street  
Suite 3100  
Chicago , IL 60603  
USA  
(312) 577-1265  
<i>pro Hac Vice</ I>

Edward John Defranco  
[COR LD NTC]  
Quinn Emanuel Urquhart Sullivan  
51 Madison Avenue, 22TH Floor  
New York , NY 10010  
USA  
212-849-7106  
Fax:  
Email: Eddefranco@quinnemanuel.com

Edward H Rice  
[COR LD NTC]  
Hopenfeld Singer Rice & Saito LLP  
30 S Wacker Drive  
suite 2200  
Chicago , IL 60606  
USA  
312-953-4566  
<i>pro Hac Vice</ I>

Kevin PB Johnson  
[COR LD NTC]  
Quinn Emanuel Urquhart & Sullivan LLP  
555 Twin Dolphin Drive  
5TH Floor  
Redwood Shores , CA 94065  
USA

650-801-5000  
Fax: 650-801-5100  
Email: KEVINJOHNSON@QUINNEMANUEL.COM

Kfir B Levy  
[COR LD NTC]  
Kellogg, Huber, Hansen, Todd, Evans & Figel, PLLC  
1615 M Street, Nw  
suite 400  
Washington , DC 20036  
USA  
202-326-7900  
fax: 202-326-7999  
email: Klevy@steptoe.Com

Margret Mary Caruso  
[COR LD NTC]  
Attorney at Law  
555 Twin Dolphin Drive,  
Suite 560  
Redwood Shores , CA 94065  
USA  
650-801-5000  
Fax: 650-801-5100  
Email: Margretcaruso@quinnemanuel.com

Marina N Saito  
[COR LD NTC]  
Hopenfeld Singer Rice & Saito LLP  
30 S Wacker Drive  
suite 2200  
Chicago , IL 60606  
USA  
312-420-5454  
<i>pro Hac Vice</ I>

Michael Richard Heibold  
[COR LD NTC]  
Steptoe & Johnson LLP  
2121 Avenue of the Stars  
Suite 2800  
Los Angeles , CA 90067  
USA  
310.734.3200  
Fax: 310.734.3300  
Email: Mheibold@steptoe.com

Michael Thomas Zeller  
[COR LD NTC]  
865 S Figueroa Street  
10TH Floor  
Los Angeles , CA 90017  
USA  
213-443-3000  
Fax: 213-443-3100

Rachel H Kassabian  
[COR LD NTC]  
Quinn Emanuel Urquhart & Sullivan LLP  
555 Twin Dolphin Drive 5TH Floor  
Redwood Shores , CA 94065  
USA  
650-801-5000  
Fax: 650-801-5100  
Email: RACHELKASSABIAN@QUINNEMANUEL.COM

Todd Michael Briggs

[COR LD NTC]  
Quinn Emanuel Urquhart & Sullivan, LLP  
555 Twin Dolphin Drive, Fifth Floor  
Redwood Shores , CA 94065  
USA  
(650) 801-5000  
Email: TODDBRIGGS@QUINNEMANUEL.COM

Victoria F Maroulis  
[COR LD NTC]  
Quinn Emanuel Urquhart Oliver & Hedges L  
555 Twin Dolphin Drive, Fifth Floor  
Redwood Shores , CA 94065  
USA  
(650) 801-5000  
Fax: (650) 801-5100  
Email: VICTORIAMAROULIS@QUINNEMANUEL.COM

Samsung Electronics Co Ltd A Korean Corporation  
Counter-Defendant

Huan-YI Lin  
[COR LD NTC]  
Steptoe Johnson LLP  
2121 Avenue of the Stars, Suite 2800  
Los Angeles , CA 90067  
USA  
310-734-1930  
Fax: 310-734-1931  
<i>pro Hac Vice</ I>  
Email: Hlin@steptoe.com

John M Caracappa  
[COR LD NTC]  
1330 Connecticut Ave, NW  
Washington , DC 20036  
USA  
202-429-3000  
Fax: 202-429-3902  
<i>pro Hac Vice</ I>  
Email: Jcaracap@steptoe.com

Thomas G Pasternak  
[COR LD NTC]  
Dla Piper US LLP  
115 South La Salle Street  
Suite 3100  
Chicago , IL 60603  
USA  
(312) 577-1265  
<i>pro Hac Vice</ I>

Edward H Rice  
[COR LD NTC]  
Hopenfeld Singer Rice & Saito LLP  
30 S Wacker Drive  
suite 2200  
Chicago , IL 60606  
USA  
312-953-4566  
<i>pro Hac Vice</ I>

Kfir B Levy  
[COR LD NTC]  
Kellogg, Huber, Hansen, Todd, Evans & Figel, PLLC  
1615 M Street, Nw  
suite 400  
Washington , DC 20036  
USA

202-326-7900  
fax: 202-326-7999  
email: Klevy@steptoe.Com

Margret Mary Caruso  
[COR LD NTC]  
Attorney at Law  
555 Twin Dolphin Drive,  
Suite 560  
Redwood Shores , CA 94065  
USA  
650-801-5000  
Fax: 650-801-5100  
Email: Margretcaruso@quinnemanuel.com

Marina N Saito  
[COR LD NTC]  
Hopenfeld Singer Rice & Saito LLP  
30 S Wacker Drive  
suite 2200  
Chicago , IL 60606  
USA  
312-420-5454  
<i>pro Hac Vice</ I >

Michael Richard Heimbald  
[COR LD NTC]  
Steptoe & Johnson LLP  
2121 Avenue of the Stars  
Suite 2800  
Los Angeles , CA 90067  
USA  
310.734.3200  
Fax: 310.734.3300  
Email: Mheimbold@steptoe.com

Rachel H Kassabian  
[COR LD NTC]  
Quinn Emanuel Urquhart & Sullivan LLP  
555 Twin Dolphin Drive 5TH Floor  
Redwood Shores , CA 94065  
USA  
650-801-5000  
Fax: 650-801-5100  
Email: RACHELKASSABIAN@QUINNEMANUEL.COM

Todd Michael Briggs  
[COR LD NTC]  
Quinn Emanuel Urquhart & Sullivan, LLP  
555 Twin Dolphin Drive, Fifth Floor  
Redwood Shores , CA 94065  
USA  
(650) 801-5000  
Email: TODDBRIGGS@QUINNEMANUEL.COM

Victoria F Maroulis  
[COR LD NTC]  
Quinn Emanuel Urquhart Oliver & Hedges L  
555 Twin Dolphin Drive, Fifth Floor  
Redwood Shores , CA 94065  
USA  
(650) 801-5000  
Fax: (650) 801-5100  
Email: VICTORIAMAROULIS@QUINNEMANUEL.COM

Samsung Telecommunications America, Llc A Delaware

Charles Kramer Verhoeven

Limited Liability Company  
Counter-Defendant

[COR LD NTC]  
Quinn Emanuel Urquhart Oliver & Hedges L  
50 California Street, 22ND Floor  
San Francisco , CA 94111  
USA  
415-875-6600  
Email: CHARLESVERHOEVEN@QUINNEMANUEL.COM

Huan-YI Lin  
[COR LD NTC]  
Steptoe Johnson LLP  
2121 Avenue of the Stars, Suite 2800  
Los Angeles , CA 90067  
USA  
310-734-1930  
Fax: 310-734-1931  
<i>pro Hac Vice</ I>  
Email: Hlin@steptoe.com

John M Caracappa  
[COR LD NTC]  
1330 Connecticut Ave, NW  
Washington , DC 20036  
USA  
202-429-3000  
Fax: 202-429-3902  
<i>pro Hac Vice</ I>  
Email: Jcaracap@steptoe.com

Thomas G Pasternak  
[COR LD NTC]  
Dla Piper US LLP  
115 South La Salle Street  
Suite 3100  
Chicago , IL 60603  
USA  
(312) 577-1265  
<i>pro Hac Vice</ I>

Edward John Defranco  
[COR LD NTC]  
Quinn Emanuel Urquhart Sullivan  
51 Madison Avenue, 22TH Floor  
New York , NY 10010  
USA  
212-849-7106  
Fax:  
Email: Eddefranco@quinnemanuel.com

Edward H Rice  
[COR LD NTC]  
Hopenfeld Singer Rice & Saito LLP  
30 S Wacker Drive  
suite 2200  
Chicago , IL 60606  
USA  
312-953-4566  
<i>pro Hac Vice</ I>

Kevin PB Johnson  
[COR LD NTC]  
Quinn Emanuel Urquhart & Sullivan LLP  
555 Twin Dolphin Drive  
5TH Floor  
Redwood Shores , CA 94065  
USA  
650-801-5000

Fax: 650-801-5100  
Email: KEVINJOHNSON@QUINNEMANUEL.COM

Kfir B Levy  
[COR LD NTC]  
Kellogg, Huber, Hansen, Todd, Evans & Figel, PLLC  
1615 M Street, Nw  
suite 400  
Washington , DC 20036  
USA  
202-326-7900  
fax: 202-326-7999  
email: Klevy@steptoe.Com

Margret Mary Caruso  
[COR LD NTC]  
Attorney at Law  
555 Twin Dolphin Drive,  
Suite 560  
Redwood Shores , CA 94065  
USA  
650-801-5000  
Fax: 650-801-5100  
Email: Margretcaruso@quinnemanuel.com

Marina N Saito  
[COR LD NTC]  
Hopenfeld Singer Rice & Saito LLP  
30 S Wacker Drive  
suite 2200  
Chicago , IL 60606  
USA  
312-420-5454  
<i>pro Hac Vice</ I>

Michael Richard Heimbold  
[COR LD NTC]  
Steptoe & Johnson LLP  
2121 Avenue of the Stars  
Suite 2800  
Los Angeles , CA 90067  
USA  
310.734.3200  
Fax: 310.734.3300  
Email: Mheimbold@steptoe.com

Michael Thomas Zeller  
[COR LD NTC]  
865 S Figueroa Street  
10TH Floor  
Los Angeles , CA 90017  
USA  
213-443-3000  
Fax: 213-443-3100

Rachel H Kassabian  
[COR LD NTC]  
Quinn Emanuel Urquhart & Sullivan LLP  
555 Twin Dolphin Drive 5TH Floor  
Redwood Shores , CA 94065  
USA  
650-801-5000  
Fax: 650-801-5100  
Email: RACHELKASSABIAN@QUINNEMANUEL.COM

Todd Michael Briggs  
[COR LD NTC]

Quinn Emanuel Urquhart & Sullivan, LLP  
555 Twin Dolphin Drive, Fifth Floor  
Redwood Shores , CA 94065  
USA  
(650) 801-5000  
Email: TODDBRIGGS@QUINNEMANUEL.COM

Victoria F Maroulis  
[COR LD NTC]  
Quinn Emanuel Urquhart Oliver & Hedges L  
555 Twin Dolphin Drive, Fifth Floor  
Redwood Shores , CA 94065  
USA  
(650) 801-5000  
Fax: (650) 801-5100  
Email: VICTORIAMAROULIS@QUINNEMANUEL.COM

Apple Inc A California Corporation  
Counter-Claimant

Michael A Jacobs  
[COR LD NTC]  
Morrison & Foerster LLP  
425 Market Street  
San Francisco , CA 94105  
USA  
(415) 268-7455  
Fax: (415) 268-7522  
Email: Mjacobs@mofo.com

Samuel Calvin Walden  
[COR LD NTC]  
Wilmer Cutler Pickering Hale and Dorr LLP  
399 Park Avenue  
New York , NY 10022  
USA  
212-230-8800  
<i>pro Hac Vice</ I>

Timonhy D Syrett  
[COR LD NTC]  
60 State Street  
Boston , MA 02109  
USA  
617-526-6975  
<i>pro Hac Vice</ I>

Ali H Shah  
[COR LD NTC]  
Wilmer Cutler Pickering Hale and Dorr LLP  
1875 Pennsylvania Avenue NW  
Washington , DC 20006  
USA  
202-663-6064  
Fax: 202-663-6363  
<i>pro Hac Vice</ I>  
Email: Ali.shah@wilmerhale.com

Alison Margaret Tucher  
[COR LD NTC]  
Morrison & Foerster LLP  
425 Market Street  
San Francisco , CA 94105  
USA  
415-268-7269  
Email: ATUCHER@MOFO.COM

Benjamin George Damstedt  
[COR LD NTC]



Cooley Godward Kronish LLP  
Five Palo Alto Square  
3000 El Camino Real  
Palo Alto , CA 94306  
USA  
650-843-5000  
Fax: 650-857-0663  
Email: BDAMSTEDT@COOLEY.COM

Brian Larivee  
[COR LD NTC]  
Wilmer Cutler Pickering Hall and Dorr LLP  
60 State Street  
Boston , MA 02109  
USA  
617-526-6226  
<i>pro Hac Vice</ I>

Brian Seeve  
[COR LD NTC]  
60 State Street  
Boston , MA 02109  
USA  
617-526-6160  
<i>pro Hac Vice</ I>

Christine E Duh  
[COR LD NTC]  
Wilmer Hale  
950 Page Mill Road  
Palo Alto , CA 94304  
USA  
650-858-6051  
Fax: 650-858-6100  
Email: CHRISTINE.DUH@WILMERHALE.COM

David B Bassett  
[COR LD NTC]  
Wilmercutler Pickering Hall and Dorr LLP  
399 Park Avenue  
New York , NY 10022  
USA  
(212) 230-8800  
Fax: (212) 230-8888  
<i>pro Hac Vice</ I>  
Email: DAVID.BASSETT@WILMERHALE.COM

Deok Keun Matthew AHN  
[COR LD NTC]  
Morrison & Foerster  
425 Market Street  
San Francisco , CA 94105  
USA  
415-268-6629  
Fax: 415-268-7522  
Email: DAHN@MOFO.COM

Emily R Whelan  
[COR LD NTC]  
Wilmer Cutler Pickering Hal and Dorr LLP  
60 State Street  
Boston , MA 02109  
USA  
617-526-6567  
Fax:  
<i>pro Hac Vice</ I>  
Email: Emily.whelan@wilmerhale.com

Esther Kim  
[COR LD NTC]  
Morrison & Foerster LLP  
425 Market Street  
San Francisco , CA 94105  
USA  
(415) 268-7000  
Fax: (415) 268-7522  
Email: EKIM@MOFO.COM

Grant L Kim  
[COR LD NTC]  
Morrison & Foerster LLP  
425 Market Street  
San Francisco , CA 94105  
USA  
415-268-7359  
Fax: 415-268-7522  
Email: Gkim@mofo.com

Harold J McElhinny  
[COR LD NTC]  
Morrison & Foerster LLP  
425 Market Street  
San Francisco , CA 94105  
USA  
(415) 268-7265  
Email: Hmcelhinny@mofo.com

James C Burling  
[COR LD NTC]  
60 State Street  
Boston , MA 02109  
USA  
617-526-6416

Jason R Bartlett  
[COR LD NTC]  
Morrison & Foerster LLP  
425 Market Street  
34TH Floor  
San Francisco , CA 94105  
USA  
415-268-6615  
Fax: 415-268-7522  
Email: JASONBARTLETT@MOFO.COM

Jennifer Lee Taylor  
[COR LD NTC]  
Morrison & Foerster LLP  
425 Market St  
San Francisco , CA 94105-2482  
USA  
(415) 268-7000  
Email: Jleetaylor@mofo.com

Jeremy Winer  
[COR LD NTC]  
Wilmer Cutler Pickering Hale and Dorr LLP  
399 Park Avenue  
New York , NY 10022  
USA  
212-230-8800  
<i>pro Hac Vice</ I>

Jesse L Dyer

[COR LD NTC]  
Cooley  
3175 Hanover Street  
Palo Alto , CA 94304  
USA  
650-843-5000  
Email: JDYER@COOLEY.COM

Kenneth Howard Bridges  
[COR LD NTC]  
Bridges & Mavrakakis LLP  
3000 El Camino Real  
One Palo Alto Square, 2ND Floor  
Palo Alto , CA 94306  
USA  
650-804-7804  
Fax: 650-852-9224  
Email: KBRIDGES@BRIDGESMAV.COM

Mark Daniel Selwyn  
[COR LD NTC]  
Wilmer Cutler Pickering Hale and Dorr LLP  
950 Page Mill Road  
Palo Alto , CA 94304  
USA  
650-858-6031  
Fax: 650-858-6100  
Email: MARK.SELWYN@WILMERHALE.COM

Michael A Diener  
[COR LD NTC]  
Wilmer Cutler Pickering Hale and Dorr LLP  
60 State Street  
Boston , MA 02109  
USA  
617-526-6454  
<i>pro Hac Vice</ I>

Michael Thomas Pieja  
[COR LD NTC]  
Bridges & Mavrakakis LLP  
3000 El Camino Real  
One Palo Alto Square, 2ND Floor  
Palo Alto , CA 94306  
USA  
650-804-7810  
Fax: 650-852-9224  
Email: MPIEJA@BRIDGESMAV.COM

Michael Saji  
[COR LD NTC]  
60 State Street  
Boston , MA 02109  
USA  
617-526-6813  
<i>pro Hac Vice</ I>

Patrick J Zhang  
[COR LD NTC]  
Morrison Foerster  
425 Market St  
San Francisco , CA 94105  
USA  
415-268-7653  
Email: PZHANG@MOFO.COM

Peter James Kolovos

[COR LD NTC]  
Wilmerhale  
60 State St  
Boston , MA 02109  
USA  
(617)526-6000  
Fax:  
<i>pro Hac Vice</ I>  
Email: Peter.kolovos@wilmerhale.com

Richard Goldenberg  
[COR LD NTC]  
Hale & Dorr, LLP  
60 State Street  
Boston , MA 02109-1803  
USA  
(617) 526-6548  
<i>pro Hac Vice</ I>

Richard SJ Hung  
[COR LD NTC]  
Morrison & Foerster LLP  
425 Market Street  
San Francisco , CA 94105  
USA  
(415) 268-7000  
Fax: (415) 268-7522  
Email: RHUNG@MOFO.COM

Robert Donald Cultice  
[COR LD NTC]  
Wilmer Cutler Pickering Hal and Dorr LLP  
60 State Street  
Boston , MA 02109  
USA  
617-526-6021  
Fax:  
<i>pro Hac Vice</ I>  
Email: Robert.cultice@wilmerhale.com

Robert J Gunther , Jr  
[COR LD NTC]  
Wilmer Cutler Pickering Hle and Dorr LLP  
399 Park Avenue  
New York , NY 10022  
USA  
212-230-8800  
<i>pro Hac Vice</ I>

Timothy S Teter  
[COR LD NTC]  
Cooley LLP  
5 Palo Alto Square  
3000 El Camino Real  
Palo Alto , CA 94306  
USA  
650-843-5000  
Fax: 650-849-7400  
Email: TETER@COOLEY.COM

Victor F Souto  
[COR LD NTC]  
Wilmerhale  
399 Park Avenue  
New York , NY 10022  
USA  
(212) 937-7224

Email: VIC.SOUTO@WILMERHALE.COM

William F Lee  
[COR LD NTC]  
Wilmer Pickering Hale and Dorr LLP  
60 State Street  
Boston , MA 02109  
USA  
617-526-65560  
Fax: 617-526-5000  
<i>pro Hac Vice</ I>  
Email: WILLIAM.LEE@WILMERHALE.COM

Samsung Electronics America, Inc A New York  
Corporation  
Counter-Defendant

Charles Kramer Verhoeven  
[COR LD NTC]  
Quinn Emanuel Urquhart Oliver & Hedges L  
50 California Street, 22ND Floor  
San Francisco , CA 94111  
USA  
415-875-6600  
Email: CHARLESVERHOEVEN@QUINNEMANUEL.COM

Huan-YI Lin  
[COR LD NTC]  
Steptoe Johnson LLP  
2121 Avenue of the Stars, Suite 2800  
Los Angeles , CA 90067  
USA  
310-734-1930  
Fax: 310-734-1931  
<i>pro Hac Vice</ I>  
Email: Hlin@steptoe.com

John M Caracappa  
[COR LD NTC]  
1330 Connecticut Ave, NW  
Washington , DC 20036  
USA  
202-429-3000  
Fax: 202-429-3902  
<i>pro Hac Vice</ I>  
Email: Jcaracap@steptoe.com

Thomas G Pasternak  
[COR LD NTC]  
Dia Piper US LLP  
115 South La Salle Street  
Suite 3100  
Chicago , IL 60603  
USA  
(312) 577-1265  
<i>pro Hac Vice</ I>

Edward John Defranco  
[COR LD NTC]  
Quinn Emanuel Urquhart Sullivan  
51 Madison Avenue, 22TH Floor  
New York , NY 10010  
USA  
212-849-7106  
Fax:  
Email: Eddefranco@quinnemanuel.com

Edward H Rice  
[COR LD NTC]  
Hopenfeld Singer Rice & Saito LLP

30 S Wacker Drive  
suite 2200  
Chicago , IL 60606  
USA  
312-953-4566  
<i>pro Hac Vice</ I>

Kevin PB Johnson  
[COR LD NTC]  
Quinn Emanuel Urquhart & Sullivan LLP  
555 Twin Dolphin Drive  
5TH Floor  
Redwood Shores , CA 94065  
USA  
650-801-5000  
Fax: 650-801-5100  
Email: KEVINJOHNSON@QUINNEMANUEL.COM

Kfir B Levy  
[COR LD NTC]  
Kellogg, Huber, Hansen, Todd, Evans & Figel, PLLC  
1615 M Street, Nw  
suite 400  
Washington , DC 20036  
USA  
202-326-7900  
fax: 202-326-7999  
email: Klevy@steptoe.Com

Margret Mary Caruso  
[COR LD NTC]  
Attorney at Law  
555 Twin Dolphin Drive,  
Suite 560  
Redwood Shores , CA 94065  
USA  
650-801-5000  
Fax: 650-801-5100  
Email: Margretcaruso@quinnemanuel.com

Marina N Saito  
[COR LD NTC]  
Hopenfeld Singer Rice & Saito LLP  
30 S Wacker Drive  
suite 2200  
Chicago , IL 60606  
USA  
312-420-5454  
<i>pro Hac Vice</ I>

Michael Richard Heimbold  
[COR LD NTC]  
Steptoe & Johnson LLP  
2121 Avenue of the Stars  
Suite 2800  
Los Angeles , CA 90067  
USA  
310.734.3200  
Fax: 310.734.3300  
Email: Mheimbold@steptoe.com

Michael Thomas Zeller  
[COR LD NTC]  
865 S Figueroa Street  
10TH Floor  
Los Angeles , CA 90017  
USA

213-443-3000  
Fax: 213-443-3100

Rachel H Kassabian  
[COR LD NTC]  
Quinn Emanuel Urquhart & Sullivan LLP  
555 Twin Dolphin Drive 5TH Floor  
Redwood Shores , CA 94065  
USA  
650-801-5000  
Fax: 650-801-5100  
Email: RACHELKASSABIAN@QUINNEMANUEL.COM

Todd Michael Briggs  
[COR LD NTC]  
Quinn Emanuel Urquhart & Sullivan, LLP  
555 Twin Dolphin Drive, Fifth Floor  
Redwood Shores , CA 94065  
USA  
(650) 801-5000  
Email: TODDBRIGGS@QUINNEMANUEL.COM

Victoria F Maroulis  
[COR LD NTC]  
Quinn Emanuel Urquhart Oliver & Hedges L  
555 Twin Dolphin Drive, Fifth Floor  
Redwood Shores , CA 94065  
USA  
(650) 801-5000  
Fax: (650) 801-5100  
Email: VICTORIAMAROULIS@QUINNEMANUEL.COM

Samsung Electronics Co Ltd A Korean Corporation  
Counter-Defendant

Huan-YI Lin  
[COR LD NTC]  
Steptoe Johnson LLP  
2121 Avenue of the Stars, Suite 2800  
Los Angeles , CA 90067  
USA  
310-734-1930  
Fax: 310-734-1931  
<i>pro Hac Vice</ I>  
Email: Hlin@steptoe.com

John M Caracappa  
[COR LD NTC]  
1330 Connecticut Ave, NW  
Washington , DC 20036  
USA  
202-429-3000  
Fax: 202-429-3902  
<i>pro Hac Vice</ I>  
Email: Jcaracap@steptoe.com

Thomas G Pasternak  
[COR LD NTC]  
Dla Piper US LLP  
115 South La Salle Street  
Suite 3100  
Chicago , IL 60603  
USA  
(312) 577-1265  
<i>pro Hac Vice</ I>

Edward H Rice  
[COR LD NTC]  
Hopfenfeld Singer Rice & Saito LLP

30 S Wacker Drive  
suite 2200  
Chicago , IL 60606  
USA  
312-953-4566  
<i>pro Hac Vice</ I>

Kfir B Levy  
[COR LD NTC]  
Kellogg, Huber, Hansen, Todd, Evans & Figel, PLLC  
1615 M Street, Nw  
suite 400  
Washington , DC 20036  
USA  
202-326-7900  
fax: 202-326-7999  
email: Klevy@steptoe.Com

Margret Mary Caruso  
[COR LD NTC]  
Attorney at Law  
555 Twin Dolphin Drive,  
Suite 560  
Redwood Shores , CA 94065  
USA  
650-801-5000  
Fax: 650-801-5100  
Email: Margretcaruso@quinnemanuel.com

Marina N Saito  
[COR LD NTC]  
Hopenfeld Singer Rice & Saito LLP  
30 S Wacker Drive  
suite 2200  
Chicago , IL 60606  
USA  
312-420-5454  
<i>pro Hac Vice</ I>

Michael Richard Heimbold  
[COR LD NTC]  
Steptoe & Johnson LLP  
2121 Avenue of the Stars  
Suite 2800  
Los Angeles , CA 90067  
USA  
310.734.3200  
Fax: 310.734.3300  
Email: Mheimbold@steptoe.com

Rachel H Kassabian  
[COR LD NTC]  
Quinn Emanuel Urquhart & Sullivan LLP  
555 Twin Dolphin Drive 5TH Floor  
Redwood Shores , CA 94065  
USA  
650-801-5000  
Fax: 650-801-5100  
Email: RACHELKASSABIAN@QUINNEMANUEL.COM

Todd Michael Briggs  
[COR LD NTC]  
Quinn Emanuel Urquhart & Sullivan, LLP  
555 Twin Dolphin Drive, Fifth Floor  
Redwood Shores , CA 94065  
USA  
(650) 801-5000



Email: TODDBRIGGS@QUINNEMANUEL.COM

Victoria F Maroulis  
[COR LD NTC]  
Quinn Emanuel Urquhart Oliver & Hedges L  
555 Twin Dolphin Drive, Fifth Floor  
Redwood Shores , CA 94065  
USA  
(650) 801-5000  
Fax: (650) 801-5100  
Email: VICTORIAMAROULIS@QUINNEMANUEL.COM

Samsung Telecommunications America, Llc A Delaware  
Limited Liability Company  
Counter-Defendant

Charles Kramer Verhoeven  
[COR LD NTC]  
Quinn Emanuel Urquhart Oliver & Hedges L  
50 California Street, 22ND Floor  
San Francisco , CA 94111  
USA  
415-875-6600  
Email: CHARLESVERHOEVEN@QUINNEMANUEL.COM

Huan-YI Lin  
[COR LD NTC]  
Steptoe Johnson LLP  
2121 Avenue of the Stars, Suite 2800  
Los Angeles , CA 90067  
USA  
310-734-1930  
Fax: 310-734-1931  
<i>pro Hac Vice</ I>  
Email: Hlin@steptoe.com

John M Caracappa  
[COR LD NTC]  
1330 Connecticut Ave, NW  
Washington , DC 20036  
USA  
202-429-3000  
Fax: 202-429-3902  
<i>pro Hac Vice</ I>  
Email: Jcaracap@steptoe.com

Thomas G Pasternak  
[COR LD NTC]  
Dla Piper US LLP  
115 South La Salle Street  
Suite 3100  
Chicago , IL 60603  
USA  
(312) 577-1265  
<i>pro Hac Vice</ I>

Edward John Defranco  
[COR LD NTC]  
Quinn Emanuel Urquhart Sullivan  
51 Madison Avenue, 22TH Floor  
New York , NY 10010  
USA  
212-849-7106  
Fax:  
Email: Eddefranco@quinnemanuel.com

Edward H Rice  
[COR LD NTC]  
Hopenfeld Singer Rice & Saito LLP  
30 S Wacker Drive

suite 2200  
Chicago , IL 60606  
USA  
312-953-4566  
<i>pro Hac Vice</ I>

Kevin PB Johnson  
[COR LD NTC]  
Quinn Emanuel Urquhart & Sullivan LLP  
555 Twin Dolphin Drive  
5TH Floor  
Redwood Shores , CA 94065  
USA  
650-801-5000  
Fax: 650-801-5100  
Email: KEVINJOHNSON@QUINNEMANUEL.COM

Kfir B Levy  
[COR LD NTC]  
Kellogg, Huber, Hansen, Todd, Evans & Figel, PLLC  
1615 M Street, Nw  
suite 400  
Washington , DC 20036  
USA  
202-326-7900  
fax: 202-326-7999  
email: Klevy@steptoe.Com

Margret Mary Caruso  
[COR LD NTC]  
Attorney at Law  
555 Twin Dolphin Drive,  
Suite 560  
Redwood Shores , CA 94065  
USA  
650-801-5000  
Fax: 650-801-5100  
Email: Margretcaruso@quinnemanuel.com

Marina N Saito  
[COR LD NTC]  
Hopenfeld Singer Rice & Saito LLP  
30 S Wacker Drive  
suite 2200  
Chicago , IL 60606  
USA  
312-420-5454  
<i>pro Hac Vice</ I>

Michael Richard Heimbold  
[COR LD NTC]  
Steptoe & Johnson LLP  
2121 Avenue of the Stars  
Suite 2800  
Los Angeles , CA 90067  
USA  
310.734.3200  
Fax: 310.734.3300  
Email: Mheimbold@steptoe.com

Michael Thomas Zeller  
[COR LD NTC]  
865 S Figueroa Street  
10TH Floor  
Los Angeles , CA 90017  
USA  
213-443-3000

Fax: 213-443-3100

Rachel H Kassabian  
 [COR LD NTC]  
 Quinn Emanuel Urquhart & Sullivan LLP  
 555 Twin Dolphin Drive 5TH Floor  
 Redwood Shores , CA 94065  
 USA  
 650-801-5000  
 Fax: 650-801-5100  
 Email: RACHELKASSABIAN@QUINNEMANUEL.COM

Todd Michael Briggs  
 [COR LD NTC]  
 Quinn Emanuel Urquhart & Sullivan, LLP  
 555 Twin Dolphin Drive, Fifth Floor  
 Redwood Shores , CA 94065  
 USA  
 (650) 801-5000  
 Email: TODDBRIGGS@QUINNEMANUEL.COM

Victoria F Maroulis  
 [COR LD NTC]  
 Quinn Emanuel Urquhart Oliver & Hedges L  
 555 Twin Dolphin Drive, Fifth Floor  
 Redwood Shores , CA 94065  
 USA  
 (650) 801-5000  
 Fax: (650) 801-5100  
 Email: VICTORIAMAROULIS@QUINNEMANUEL.COM

Date	#	Proceeding Text	Source
04/15/2011	1	COMPLAINT (with jury demand) against Samsung Electronics America, Inc., Samsung Electronics Co. Ltd., Samsung Telecommunications America, LLC (Filing fee \$ 350, receipt number 34611058762). Filed by Apple Inc. (Attachments: # 1 Exhibit 1, # 2 Exhibit 2, # 3 Exhibit 3, # 4 Exhibit 4, # 5 Exhibit 5, # 6 Exhibit 6, # 7 Exhibit 7, # 8 Exhibit 8, # 9 Exhibit 9, # 10 Exhibit 10, # 11 Exhibit 11, # 12 Exhibit 12, # 13 Exhibit 13, # 14 Exhibit 14, # 15 Exhibit 15, # 16 Exhibit 16, # 17 Exhibit 17, # 18 Exhibit 18, # 19 Exhibit 19, # 20 Exhibit 20, # 21 Exhibit 21, # 22 Civil Cover Sheet)(cjl, COURT STAFF) (Filed on 4/15/2011) (Entered: 04/19/2011)	
04/15/2011	2	Certificate of Interested Entities by Apple Inc. (cjl, COURT STAFF) (Filed on 4/15/2011) (Entered: 04/19/2011)	
04/15/2011	3	Disclosure Statement by Apple Inc. (cjl, COURT STAFF) (Filed on 4/15/2011) (Entered: 04/19/2011)	
04/15/2011	4	Summons Issued as to Samsung Electronics America, Inc. (cjl, COURT STAFF) (Filed on 4/15/2011) (Entered: 04/19/2011)	
04/15/2011	5	Summons Issued as to Samsung Telecommunications America, LLC. (cjl, COURT STAFF) (Filed on 4/15/2011) (Entered: 04/19/2011)	
04/15/2011	6	Summons Issued as to Samsung Electronics Co. Ltd. (cjl, COURT STAFF) (Filed on 4/15/2011) (Entered: 04/19/2011)	
04/15/2011	7	ADR SCHEDULING ORDER: Case Management Statement due by 9/1/2011. Case Management Conference set for 9/8/2011 10:30 AM in Courtroom 4, 3rd Floor, Oakland. (Attachments: # 1 Standing Order)(cjl, COURT STAFF) (Filed on 4/15/2011) (Entered: 04/19/2011)	
04/15/2011	--	CASE DESIGNATED for Electronic Filing. (cjl, COURT STAFF) (Filed on 4/15/2011) (Entered: 04/19/2011)	
04/19/2011	8	REPORT on the filing of an action regarding Trademark and Patent (cc: form mailed to register). (cjl, COURT STAFF) (Filed on 4/19/2011) (Entered: 04/19/2011)	
04/19/2011	9	Declination to Proceed Before a U.S. Magistrate Judge by Apple Inc.. (Bartlett, Jason) (Filed on 4/19/2011) (Entered: 04/19/2011)	

- 04/19/2011 10 MOTION to Expedite Discovery filed by Apple Inc.. (Bartlett, Jason) (Filed on 4/19/2011) (Entered: 04/19/2011)
- 04/19/2011 11 Declaration of Jason Bartlett in Support of 10 MOTION to Expedite Discovery filed by Apple Inc.. (Attachments: # 1 Exhibit 1, # 2 Exhibit 2, # 3 Exhibit 3, # 4 Exhibit 4, # 5 Exhibit 5, # 6 Exhibit 6, # 7 Exhibit 7, # 8 Exhibit 8, # 9 Exhibit 9, # 10 Exhibit 10, # 11 Exhibit 11, # 12 Proposed Order Proposed Order)(Related document(s) 10 ) (Bartlett, Jason) (Filed on 4/19/2011) (Entered: 04/19/2011)
- 04/19/2011 12 MOTION to Shorten Time for Briefing and Hearing on Plaintiff's Motion to Expedite Discovery filed by Apple Inc.. (Bartlett, Jason) (Filed on 4/19/2011) (Entered: 04/19/2011)
- 04/19/2011 13 Declaration of Jason Bartlett and [Proposed] Order in Support of 12 MOTION to Shorten Time for Briefing and Hearing on Plaintiff's Motion to Expedite Discovery filed by Apple Inc. (Attachments: # 1 Proposed Order Proposed Order)(Related document(s) 12 ) (Bartlett, Jason) (Filed on 4/19/2011) Modified on 4/20/2011 (cjl, COURT STAFF). (Entered: 04/19/2011)
- 04/20/2011 14 CERTIFICATE OF SERVICE by Apple Inc. re 11 Declaration in Support, 10 MOTION to Expedite Discovery , 12 MOTION to Shorten Time for Briefing and Hearing on Plaintiff's Motion to Expedite Discovery , 13 Declaration in Support, (Taylor, Jennifer) (Filed on 4/20/2011) (Entered: 04/20/2011)
- 04/21/2011 15 CLERK'S NOTICE of Impending Reassignment to U.S. District Judge. (Is, COURT STAFF) (Filed on 4/21/2011) (Entered: 04/21/2011)
- 04/21/2011 16 Amendment to 14 Certificate of Service by Apple Inc. (Taylor, Jennifer) (Filed on 4/21/2011) Modified on 4/22/2011 (cjl, COURT STAFF). (Entered: 04/21/2011)
- 04/21/2011 17 \*\*\* FILED IN ERROR. PLEASE SEE DOCKET # 20 . \*\*\* SUMMONS Returned Executed by Apple Inc.. Apple Inc. served on 4/21/2011, answer due 5/12/2011. Re Samsung Telecommunications America, LLC (Taylor, Jennifer) (Filed on 4/21/2011) Modified on 4/22/2011 (ewn, COURT STAFF). (Entered: 04/21/2011)
- 04/21/2011 18 SUMMONS Returned Executed by Apple Inc.. Samsung Electronics America, Inc. served on 4/21/2011, answer due 5/12/2011. (Taylor, Jennifer) (Filed on 4/21/2011) (Entered: 04/21/2011)
- 04/22/2011 19 ORDER REASSIGNING CASE. Case reassigned to Judge Hon. Lucy H. Koh for all further proceedings. Magistrate Judge Laurel Beeler no longer assigned to the case. Signed by the Executive Committee on April 22, 2011. (cjl, COURT STAFF) (Filed on 4/22/2011) (Entered: 04/22/2011)
- 04/22/2011 20 SUMMONS Returned Executed by Apple Inc.. Samsung Telecommunications America, LLC served on 4/21/2011, answer due 5/12/2011. (Taylor, Jennifer) (Filed on 4/22/2011) (Entered: 04/22/2011)
- 04/25/2011 21 NOTICE of Appearance by Victoria F. Maroulis as Counsel of Record for Samsung Electronics America, Inc. and Samsung Telecommunications America, LLC (Maroulis, Victoria) (Filed on 4/25/2011) (Entered: 04/25/2011)
- 04/25/2011 22 Certificate of Interested Entities by Samsung Electronics America, Inc., Samsung Telecommunications America, LLC (Maroulis, Victoria) (Filed on 4/25/2011) (Entered: 04/25/2011)
- 04/25/2011 23 OPPOSITION to ( 12 MOTION to Shorten Time for Briefing and Hearing on Plaintiff's Motion to Expedite Discovery ) filed by Samsung Electronics America, Inc., Samsung Telecommunications America, LLC. (Maroulis, Victoria) (Filed on 4/25/2011) Modified text on 5/3/2011 (dhm, COURT STAFF). (Entered: 04/25/2011)
- 04/25/2011 24 Declaration of Victoria F. Maroulis in Support of 23 Opposition/Response to Motion filed by Samsung Electronics America, Inc., Samsung Telecommunications America, LLC. (Attachments: # 1 Exhibit A, # 2 Exhibit B)(Related document(s) 23 ) (Maroulis, Victoria) (Filed on 4/25/2011) (Entered: 04/25/2011)
- 04/25/2011 25 Proposed Order re 12 Plaintiff's Motion to Shorten Time for Briefing and Hearing on Plaintiff's Motion to Expedite Discovery by Samsung Electronics America, Inc., Samsung Telecommunications America, LLC. (Maroulis, Victoria) (Filed on 4/25/2011) Modified on 5/3/2011 counsel failed to link entry to document #12 (dhm, COURT STAFF). (Entered: 04/25/2011)
- 04/26/2011 26 ORDER Granting in Part 12 MOTION to Shorten Time for Briefing and Hearing on Plaintiff's Motion to Expedite Discovery. Motion Hearing set for 5/12/2011 01:30 PM in Courtroom 4, 5th Floor, San Jose before Hon. Lucy H. Koh. Signed by Judge Koh on

- 4/26/2011. (lhk1c1, COURT STAFF) (Filed on 4/26/2011) (Entered: 04/26/2011)
- 04/26/2011 27 NOTICE of Appearance by Deok Keun Matthew Ahn (Ahn, Deok Keun) (Filed on 4/26/2011) (Entered: 04/26/2011)
- 04/26/2011 28 NOTICE of Appearance by Charles Kramer Verhoeven for Samsung Electronics America, Inc. and Samsung Telecommunications America, LLC (Verhoeven, Charles) (Filed on 4/26/2011) (Entered: 04/26/2011)
- 04/26/2011 29 NOTICE of Appearance by Kevin P.B. Johnson for Samsung Electronics America, Inc. and Samsung Telecommunications America, LLC (Johnson, Kevin) (Filed on 4/26/2011) (Entered: 04/26/2011)
- 05/05/2011 30 Administrative Motion to File Under Seal Samsung's Opposition to Apple's Motion to Expedite Discovery and the Declarations of Brian Rosenberg and Travis Merrill In Support of Samsung's Opposition filed by Samsung Electronics America, Inc., Samsung Telecommunications America, LLC. (Attachments: # 1 Declaration of Brian Rosenberg In Support of Samsung's Administrative Motion to File Documents Under Seal, # 2 Declaration of Travis Merrill in support of Samsung's Administrative Motion to File Documents Under Seal, # 3 Declaration of Victoria F. Maroulis In Support of Samsung's Administrative Motion to File Documents Under Seal, # 4 Proposed Order Granting Samsung's Administrative Motion to File Documents Under Seal)(Maroulis, Victoria) (Filed on 5/5/2011) (Entered: 05/05/2011)
- 05/05/2011 31 Proposed Order re 10 MOTION to Expedite Discovery [Proposed] Order Denying Plaintiff's Motion to Expedite Discovery by Samsung Electronics America, Inc., Samsung Telecommunications America, LLC. (Maroulis, Victoria) (Filed on 5/5/2011) (Entered: 05/05/2011)
- 05/05/2011 32 Declaration of Erik Olson In Support of 23 Samsung's Opposition to Plaintiff's Motion to Expedite Discovery filed by Samsung Electronics America, Inc., Samsung Telecommunications America, LLC. (Attachments: # 1 Exhibit A)(Maroulis, Victoria) (Filed on 5/5/2011) Modified on 5/16/2011 linking entry to document #23 (dhm, COURT STAFF). (Entered: 05/05/2011)
- 05/05/2011 33 CERTIFICATE OF SERVICE by Samsung Electronics America, Inc., Samsung Telecommunications America, LLC of Documents Submitted Under Seal (Maroulis, Victoria) (Filed on 5/5/2011) (Entered: 05/05/2011)
- 05/09/2011 34 REPLY (re 10 MOTION to Expedite Discovery ) IN SUPPORT OF PLAINTIFF'S MOTION TO EXPEDITE DISCOVERY filed by Apple Inc.. (Bartlett, Jason) (Filed on 5/9/2011) (Entered: 05/09/2011)
- 05/09/2011 35 Declaration of JASON R. BARTLETT in Support of 34 Reply to Opposition/Response PLAINTIFF'S REPLY IN SUPPORT OF ITS MOTION TO EXPEDITE DISCOVERY filed by Apple Inc.. (Related document(s) 34 ) (Bartlett, Jason) (Filed on 5/9/2011) (Entered: 05/09/2011)
- 05/09/2011 36 CERTIFICATE OF SERVICE by Apple Inc. re 35 Declaration in Support, 34 Reply to Opposition/Response (Bartlett, Jason) (Filed on 5/9/2011) (Entered: 05/09/2011)
- 05/09/2011 37 STIPULATION AND [PROPOSED] ORDER by Apple Inc.. (Bartlett, Jason) (Filed on 5/9/2011) (Entered: 05/09/2011)
- 05/10/2011 38 ORDER by Judge Koh granting 30 Administrative Motion to File Under Seal. (lhk1c1, COURT STAFF) (Filed on 5/10/2011) (Entered: 05/10/2011)
- 05/10/2011 39 CLERKS NOTICE SETTING CASE MANAGEMENT CONFERENCE Case Management Statement due by 8/17/2011. Case Management Conference set for 8/24/2011 02:00 PM in Courtroom 4, 5th Floor, San Jose. (mpb, COURT STAFF) (Filed on 5/10/2011) (Entered: 05/10/2011)
- 05/10/2011 40 STIPULATION AND ORDER Regarding Service of Process re 37 . Signed by Judge Koh on 5/10/2011. (lhk1c1, COURT STAFF) (Filed on 5/10/2011) (Entered: 05/10/2011)
- 05/11/2011 -- Case Assigned to Magistrate Judge Paul Singh Grewal for all discovery matters. (tsh, COURT STAFF) (Filed on 5/11/2011) (Entered: 05/11/2011)
- 05/11/2011 41 MOTION to Relate Case filed by Samsung Electronics America, Inc., Samsung Electronics Co. Ltd., Samsung Telecommunications America, LLC. (Attachments: # 1 Proposed Order Granting Samsung's Civil L.R. 3-12(b) Motion to Consider Cases Related)(Maroulis, Victoria) (Filed on 5/11/2011) (Entered: 05/11/2011)
- 05/11/2011 42 Declaration of Victoria F. Maroulis in Support of 41 MOTION to Relate Case filed by Samsung Electronics America, Inc., Samsung Electronics Co. Ltd., Samsung Telecommunications America, LLC. (Attachments: # 1 Exhibit A, # 2 Exhibit B, # 3

Exhibit C, # 4 Exhibit D, # 5 Exhibit E (part 1), # 6 Exhibit E (part 2), # 7 Exhibit F, # 8 Exhibit G, # 9 Exhibit H, # 10 Exhibit I, # 11 Exhibit J, # 12 Exhibit K, # 13 Exhibit L, # 14 Exhibit M)(Related document(s) 41 ) (Maroulis, Victoria) (Filed on 5/11/2011) (Entered: 05/11/2011)

- 05/12/2011 43 CERTIFICATE OF SERVICE by Samsung Electronics America, Inc., Samsung Electronics Co. Ltd., Samsung Telecommunications America, LLC of Samsung's Civil L.R. 3-12(b) Motion to Relate Cases (Maroulis, Victoria) (Filed on 5/12/2011) (Entered: 05/12/2011)
- 05/12/2011 44 DOCUMENT E-FILED UNDER SEAL re 38 Order on Administrative Motion to File Under Seal Samsung's Opposition to Plaintiff's Motion to Expedite Discovery by Samsung Electronics America, Inc., Samsung Telecommunications America, LLC. (Maroulis, Victoria) (Filed on 5/12/2011) (Entered: 05/12/2011)
- 05/12/2011 45 DOCUMENT E-FILED UNDER SEAL re 38 Order on Administrative Motion to File Under Seal Declaration of Brian Rosenberg In Support of Samsung's Opposition to Plaintiff's Motion to Expedite Discovery by Samsung Electronics America, Inc., Samsung Telecommunications America, LLC. (Maroulis, Victoria) (Filed on 5/12/2011) (Entered: 05/12/2011)
- 05/12/2011 46 DOCUMENT E-FILED UNDER SEAL re 38 Order on Administrative Motion to File Under Seal Declaration of Travis Merrill In Support of Samsung's Opposition to Plaintiff's Motion to Expedite Discovery by Samsung Electronics America, Inc., Samsung Telecommunications America, LLC. (Maroulis, Victoria) (Filed on 5/12/2011) (Entered: 05/12/2011)
- 05/12/2011 47 OPPOSITION to ( 10 MOTION to Expedite Discovery) Public Redacted Version of Samsung's Opposition to Plaintiff's Motion to Expedite Discovery filed by Samsung Electronics America, Inc., Samsung Telecommunications America, LLC. (Maroulis, Victoria) (Filed on 5/12/2011) Modified text on 5/19/2011 (dhm, COURT STAFF). (Entered: 05/12/2011)
- 05/12/2011 50 Minute Entry: Motion Hearing held on 5/12/2011 before Judge Lucy H. Koh (Date Filed: 5/12/2011) re 10 MOTION to Expedite Discovery filed by Apple Inc.. (Court Reporter Lee-Anne Shortridge.) (mpb, COURT STAFF) (Date Filed: 5/12/2011) (Entered: 05/17/2011)
- 05/16/2011 48 NOTICE of Appearance by Mark Daniel Selwyn Notice of Special Appearance of Counsel on Behalf of Apple Inc. (Selwyn, Mark) (Filed on 5/16/2011) (Entered: 05/16/2011)
- 05/16/2011 49 RESPONSE (re 41 MOTION to Relate Case ) Apple Inc.'s Opposition to Samsung's Civil L.R. 3-12(b) Motion to Consider Whether Cases Should be Related filed by Apple Inc.. (Selwyn, Mark) (Filed on 5/16/2011) (Entered: 05/16/2011)
- 05/17/2011 51 Proposed Order re 41 Samsung's Civil L.R.3-12(b) Motion To Consider Whether Cases Should Be Related by Apple Inc.. (Selwyn, Mark) (Filed on 5/17/2011) Modified on 5/20/2011 linking entry to document #41(dhm, COURT STAFF). (Entered: 05/17/2011)
- 05/18/2011 52 ORDER by Judge Koh Granting Limited Expedited Discovery re 10 . (lhk1c1, COURT STAFF) (Filed on 5/18/2011) (Entered: 05/18/2011)
- 05/18/2011 53 REPLY (re 41 MOTION to Relate Case ) filed by Samsung Electronics America, Inc., Samsung Electronics Co. Ltd., Samsung Telecommunications America, LLC. (Maroulis, Victoria) (Filed on 5/18/2011) (Entered: 05/18/2011)
- 05/19/2011 54 CERTIFICATE OF SERVICE by Samsung Electronics America, Inc., Samsung Electronics Co. Ltd., Samsung Telecommunications America, LLC re 53 Reply to Opposition/Response (Maroulis, Victoria) (Filed on 5/19/2011) (Entered: 05/19/2011)
- 05/23/2011 55 ORDER by Judge Lucy H. Koh granting 41 Motion to Relate Case. Case 11-CV-02079 EDL is related to this case. (mpb, COURT STAFF) (Filed on 5/23/2011) (Entered: 05/23/2011)
- 05/27/2011 56 MOTION to Compel Apple to Produce Reciprocal Expedited Discovery filed by Samsung Electronics America, Inc., Samsung Electronics Co. Ltd., Samsung Telecommunications America, LLC. Motion Hearing set for 9/1/2011 01:30 PM in Courtroom 4, 5th Floor, San Jose before Hon. Lucy H. Koh. (Attachments: # 1 Proposed Order Granting Samsung's Motion to Compel Apple to Produce Reciprocal Expedited Discovery)(Maroulis, Victoria) (Filed on 5/27/2011) (Entered: 05/27/2011)
- 05/27/2011 57 Declaration of Todd M. Briggs in Support of 56 MOTION to Compel Apple to Produce Reciprocal Expedited Discovery filed by Samsung Electronics America, Inc., Samsung Electronics Co. Ltd., Samsung Telecommunications America, LLC. (Attachments: # 1 Exhibit 1, # 2 Exhibit 2, # 3 Exhibit 3, # 4 Exhibit 4, # 5 Exhibit 5, # 6 Exhibit 6, # 7 Exhibit 7, # 8 Exhibit 8, # 9 Exhibit 9, # 10 Exhibit 10, # 11 Exhibit 11, # 12 Exhibit 12, # 13 Exhibit 13, # 14 Exhibit 14, # 15 Exhibit 15, # 16 Exhibit 16, # 17 Exhibit 17, # 18

Exhibit 18, # 19 Exhibit 19, # 20 Exhibit 20, # 21 Exhibit 21, # 22 Exhibit 22, # 23 Exhibit 23, # 24 Exhibit 24, # 25 Exhibit 25, # 26 Exhibit 26, # 27 Exhibit 27, # 28 Exhibit 28)(Related document(s) 56 ) (Maroulis, Victoria) (Filed on 5/27/2011) (Entered: 05/27/2011)

- 05/27/2011 58 MOTION to Shorten Time for Briefing and Hearing Schedule on Samsung's Motion to Compel Apple to Produce Reciprocal Expedited Discovery filed by Samsung Electronics America, Inc., Samsung Electronics Co. Ltd., Samsung Telecommunications America, LLC. (Attachments: # 1 Proposed Order Granting Samsung's Unopposed Motion to Shorten Time)(Maroulis, Victoria) (Filed on 5/27/2011) (Entered: 05/27/2011)
- 06/01/2011 59 ORDER Granting in Part 58 MOTION to Shorten Time for Briefing and Hearing Schedule on Samsung's Motion to Compel. Motion Hearing set for 6/17/2011 01:30 PM in Courtroom 4, 5th Floor, San Jose before Hon. Lucy H. Koh. Signed by Judge Koh on 6/1/2011. (lhk1c1, COURT STAFF) (Filed on 6/1/2011) (Entered: 06/01/2011)
- 06/07/2011 60 Administrative Motion to File Under Seal Apple's Stipulated Administrative Motion to File Documents Under Seal filed by Apple Inc.. (Attachments: # 1 Whitt Declaration, # 2 Bartlett Declaration, # 3 Proposed Order)(Bartlett, Jason) (Filed on 6/7/2011) Modified on 6/8/2011 (ewn, COURT STAFF). (Entered: 06/07/2011)
- 06/07/2011 61 Declaration of GRANT L. KIM IN SUPPORT OF APPLES OPPOSITION TO SAMSUNGS MOTION TO COMPEL EXPEDITED DISCOVERY filed by Apple Inc.. (Attachments: # 1 Exhibit Ex 1, # 2 Exhibit Ex 2, # 3 Exhibit Ex 3, # 4 Exhibit Ex 4, # 5 Exhibit Ex 5, # 6 Exhibit Ex 6, # 7 Exhibit Ex 7, # 8 Exhibit Ex 8, # 9 Exhibit Ex 9, # 10 Exhibit Ex 10, # 11 Exhibit Ex 11, # 12 Exhibit Ex 12, # 13 Exhibit Ex 13, # 14 Exhibit Ex 14, # 15 Exhibit Ex 15, # 16 Exhibit Ex 16, # 17 Exhibit Ex 17, # 18 Exhibit Ex 18, # 19 Exhibit Ex 19, # 20 Exhibit Ex 20, # 21 Exhibit Ex 21, # 22 Exhibit Ex 22, # 23 Exhibit Ex 23, # 24 Exhibit Ex 24, # 25 Exhibit Ex 25, # 26 Exhibit Ex 26, # 27 Exhibit Ex 27, # 28 Exhibit Ex 28, # 29 Exhibit Ex 29, # 30 Exhibit Ex 30)(Bartlett, Jason) (Filed on 6/7/2011) (Entered: 06/07/2011)
- 06/07/2011 62 Proposed Order DENYING SAMSUNG'S MOTION TO COMPEL EXPEDITED DISCOVERY by Apple Inc.. (Bartlett, Jason) (Filed on 6/7/2011) (Entered: 06/07/2011)
- 06/07/2011 63 CERTIFICATE OF SERVICE by Apple Inc. re 44 , 45 (Bartlett, Jason) (Filed on 6/7/2011) Modified on 6/10/2011 (dhm, COURT STAFF). (Entered: 06/07/2011)
- 06/10/2011 64 REPLY (re 56 MOTION to Compel Apple to Produce Reciprocal Expedited Discovery ) filed by Samsung Electronics America, Inc., Samsung Electronics Co. Ltd., Samsung Telecommunications America, LLC. (Maroulis, Victoria) (Filed on 6/10/2011) (Entered: 06/10/2011)
- 06/10/2011 65 Declaration of Erik Olson in Support of 64 Reply to Opposition/Response to Samsung's Motion to Compel Apple to Produce Reciprocal Expedited Discovery filed by Samsung Electronics America, Inc., Samsung Electronics Co. Ltd., Samsung Telecommunications America, LLC. (Attachments: # 1 Exhibit 1, # 2 Exhibit 2, # 3 Exhibit 3)(Related document(s) 64 ) (Maroulis, Victoria) (Filed on 6/10/2011) (Entered: 06/10/2011)
- 06/13/2011 66 Order by Hon. Lucy H. Koh granting 60 Administrative Motion to File Under Seal.(lhk1c1, COURT STAFF) (Filed on 6/13/2011) (Entered: 06/13/2011)
- 06/13/2011 67 DOCUMENT E-FILED UNDER SEAL re 66 Order on Administrative Motion to File Under Seal Apple's Opposition to Samsung's Motion to Compel Expedited Discovery by Apple Inc.. (Bartlett, Jason) (Filed on 6/13/2011) (Entered: 06/13/2011)
- 06/13/2011 68 OPPOSITION to ( 56 MOTION to Compel Apple to Produce Reciprocal Expedited Discovery ) (Public Redacted Version) filed by Apple Inc.. (Bartlett, Jason) (Filed on 6/13/2011) Modified text on 6/16/2011 (dhm, COURT STAFF). (Entered: 06/13/2011)
- 06/13/2011 69 DOCUMENT E-FILED UNDER SEAL re 66 Order on Administrative Motion to File Under Seal Declaration of Richard J. Lutton in Support of Apple's Opposition to Samsung's Motion to Compel Expedited Discovery by Apple Inc.. (Bartlett, Jason) (Filed on 6/13/2011) (Entered: 06/13/2011)
- 06/13/2011 70 Declaration of Richard J. Lutton in Support of 68 Apple's Opposition to Samsung's Motion to Compel Expedited Discovery (Public Redacted Version) filed by Apple Inc.. (Bartlett, Jason) (Filed on 6/13/2011) Modified on 6/16/2011 linking entry to document #68 (dhm, COURT STAFF). (Entered: 06/13/2011)
- 06/15/2011 71 NOTICE of Appearance by Alison Margaret Tucher Notice of Appearance by Alison M. Tucher (Tucher, Alison) (Filed on 6/15/2011) (Entered: 06/15/2011)
- 06/15/2011 72 NOTICE of Appearance by Grant L. Kim (Kim, Grant) (Filed on 6/15/2011) (Entered: 06/15/2011)

- 06/16/2011 73 NOTICE of Appearance by Kenneth Howard Bridges (Bridges, Kenneth) (Filed on 6/16/2011) (Entered: 06/16/2011)
- 06/16/2011 74 NOTICE of Appearance by Michael Thomas Pieja (Pieja, Michael) (Filed on 6/16/2011) (Entered: 06/16/2011)
- 06/16/2011 75 AMENDED COMPLAINT for Federal False Designation of Origin and Unfair Competition, Federal Trademark Infringement, Federal Trade Dress Dilution, State Unfair Business Practices, Common Law Trademark Infringement, Unjust Enrichment, and Patent Infringement against Samsung Electronics America, Inc., Samsung Electronics Co. Ltd., Samsung Telecommunications America, LLC. Filed by Apple Inc.. (Attachments: # 1 Exhibit 1, # 2 Exhibit 2, # 3 Exhibit 3, # 4 Exhibit 4, # 5 Exhibit 5, # 6 Exhibit 6, # 7 Exhibit 7, # 8 Exhibit 8, # 9 Exhibit 9, # 10 Exhibit 10, # 11 Exhibit 11, # 12 Exhibit 12, # 13 Exhibit 13, # 14 Exhibit 14, # 15 Exhibit 15, # 16 Exhibit 16, # 17 Exhibit 17, # 18 Exhibit 18, # 19 Exhibit 19, # 20 Exhibit 20, # 21 Exhibit 21, # 22 Exhibit 22, # 23 Exhibit 23, # 24 Exhibit 24, # 25 Exhibit 25, # 26 Exhibit 26, # 27 Exhibit 27, # 28 Exhibit 28, # 29 Exhibit 29, # 30 Exhibit 30, # 31 Exhibit 31, # 32 Exhibit 32, # 33 Exhibit 33, # 34 Exhibit 34, # 35 Exhibit 35)(Jacobs, Michael) (Filed on 6/16/2011) (Entered: 06/16/2011)
- 06/16/2011 76 STIPULATION to Modification of Patent L.R. 2-2 Interim Protective Order for Purposes of Expedited Discovery by Samsung Electronics America, Inc., Samsung Electronics Co. Ltd., Samsung Telecommunications America, LLC. (Maroulis, Victoria) (Filed on 6/16/2011) (Entered: 06/16/2011)
- 06/17/2011 77 Minute Entry: Motion Hearing held on 6/17/2011 before Judge Lucy H. Koh (Date Filed: 6/17/2011) re 56 MOTION to Compel Apple to Produce Reciprocal Expedited Discovery filed by Samsung Electronics Co. Ltd., Samsung Telecommunications America, LLC, Samsung Electronics America, Inc.. (Court Reporter Irene Rodriguez.) (mpb, COURT STAFF) (Date Filed: 6/17/2011) (Entered: 06/20/2011)
- 06/21/2011 78 Transcript of Proceedings held on 06/17/2011, before Judge Koh. Court Reporter/Transcriber Irene L. Rodriguez, Telephone number (408)947-8160. Per General Order No. 59 and Judicial Conference policy, this transcript may be viewed only at the Clerks Office public terminal or may be purchased through the Court Reporter/Transcriber until the deadline for the Release of Transcript Restriction. After that date it may be obtained through PACER. Any Notice of Intent to Request Redaction, if required, is due no later than 5 business days from date of this filing. Redaction Request due 7/12/2011. Redacted Transcript Deadline set for 7/22/2011. Release of Transcript Restriction set for 9/19/2011. (Rodriguez, Irene) (Filed on 6/21/2011) (Entered: 06/21/2011)
- 06/21/2011 79 ORDER Denying 56 MOTION to Compel Apple to Produce Reciprocal Expedited Discovery. Signed by Judge Koh on 6/21/2011. (lhkic1, COURT STAFF) (Filed on 6/21/2011) (Entered: 06/21/2011)
- 06/30/2011 80 Samsung Entities' ANSWER to Amended Complaint of Apple Inc. , COUNTERCLAIM by Samsung Entities against Apple Inc. by Samsung Telecommunications America, LLC, Samsung Electronics America, Inc., Samsung Electronics Co. Ltd.. (Attachments: # 1 Exhibit 1, # 2 Exhibit 2, # 3 Exhibit 3, # 4 Exhibit 4, # 5 Exhibit 5, # 6 Exhibit 6, # 7 Exhibit 7, # 8 Exhibit 8, # 9 Exhibit 9, # 10 Exhibit 10, # 11 Exhibit 11, # 12 Exhibit 12) (Maroulis, Victoria) (Filed on 6/30/2011) (Entered: 06/30/2011)
- 07/01/2011 81 MOTION for Leave to File Excess Pages in Connection with Motion for A Preliminary Injunction filed by Apple Inc.. (Attachments: # 1 Proposed Order)(Bartlett, Jason) (Filed on 7/1/2011) (Entered: 07/01/2011)
- 07/01/2011 82 Administrative Motion to File Under Seal in Connection with Motion for A Preliminary Injunction filed by Apple Inc.. (Attachments: # 1 Declaration of Richard J. Lutton, Jr., # 2 Proposed Order)(Bartlett, Jason) (Filed on 7/1/2011) (Entered: 07/01/2011)
- 07/01/2011 83 MOTION to Expedite Trial and Case Management Conference filed by Apple Inc.. (Attachments: # 1 Proposed Order)(Bartlett, Jason) (Filed on 7/1/2011) (Entered: 07/01/2011)
- 07/01/2011 84 MOTION to Shorten Time for Briefing on Apple's Motion for Expedited Trial and Case Management Conference filed by Apple Inc.. (Attachments: # 1 Proposed Order)(Bartlett, Jason) (Filed on 7/1/2011) (Entered: 07/01/2011)
- 07/01/2011 85 Declaration of Richard S.J. Hung in Support of 82 Administrative Motion to File Under Seal in Connection with Motion for A Preliminary Injunction , 81 MOTION for Leave to File Excess Pages in Connection with Motion for A Preliminary Injunction , 84 MOTION to Shorten Time for Briefing on Apple's Motion for Expedited Trial and Case Management



- Conference , 83 MOTION to Expedite Trial and Case Management Conference filed by Apple Inc.. (Attachments: # 1 Exhibit 1, # 2 Exhibit 2)(Related document(s) 82 , 81 , 84 , 83 ) (Bartlett, Jason) (Filed on 7/1/2011) (Entered: 07/01/2011)
- 07/01/2011 86 MOTION for Preliminary Injunction filed by Apple Inc.. Motion Hearing set for 8/5/2011 01:30 PM in Courtroom 4, 5th Floor, San Jose before Hon. Lucy H. Koh. Responses due by 7/15/2011. Replies due by 7/22/2011. (Attachments: # 1 Proposed Order)(Bartlett, Jason) (Filed on 7/1/2011) (Entered: 07/01/2011)
- 07/01/2011 87 Declaration of Patrick Zhang in Support of 86 MOTION for Preliminary Injunction filed by Apple Inc.. (Attachments: # 1 Exhibit 1, # 2 Exhibit 2, # 3 Exhibit 3, # 4 Exhibit 4, # 5 Exhibit 5, # 6 Exhibit 6, # 7 Exhibit 7, # 8 Exhibit 8, # 9 Exhibit 9, # 10 Exhibit 10, # 11 Exhibit 11, # 12 Exhibit 12, # 13 Exhibit 13, # 14 Exhibit 14, # 15 Exhibit 15, # 16 Exhibit 16, # 17 Exhibit 17, # 18 Exhibit 18, # 19 Exhibit 19, # 20 Exhibit 20, # 21 Exhibit 21, # 22 Exhibit 22, # 23 Exhibit 23, # 24 Exhibit 24, # 25 Exhibit 25, # 26 Exhibit 26, # 27 Exhibit 27, # 28 Exhibit 28, # 29 Exhibit 29, # 30 Exhibit 30, # 31 Exhibit 31, # 32 Exhibit 32, # 33 Exhibit 33, # 34 Exhibit 34, # 35 Exhibit 35, # 36 Exhibit 36, # 37 Exhibit 37, # 38 Exhibit 38, # 39 Exhibit 39, # 40 Exhibit 40, # 41 Exhibit 41, # 42 Exhibit 42, # 43 Exhibit 43, # 44 Exhibit 44, # 45 Exhibit 45, # 46 Exhibit 46, # 47 Exhibit 47, # 48 Exhibit 48, # 49 Exhibit 49, # 50 Exhibit 50, # 51 Exhibit 51, # 52 Exhibit 52)(Related document(s) 86 ) (Bartlett, Jason) (Filed on 7/1/2011) (Entered: 07/01/2011)
- 07/01/2011 88 Declaration of Jason Bartlett in Support of 86 MOTION for Preliminary Injunction filed by Apple Inc.. (Attachments: # 1 Exhibit 1, # 2 Exhibit 2, # 3 Exhibit 3, # 4 Exhibit 4, # 5 Exhibit 5, # 6 Exhibit 6, # 7 Exhibit 7, # 8 Exhibit 8, # 9 Exhibit 9, # 10 Exhibit 10, # 11 Exhibit 11, # 12 Exhibit 12, # 13 Exhibit 13, # 14 Exhibit 14, # 15 Exhibit 15, # 16 Exhibit 16, # 17 Exhibit 17, # 18 Exhibit 18, # 19 Exhibit 19, # 20 Exhibit 20, # 21 Errata 21, # 22 Exhibit 22, # 23 Exhibit 23, # 24 Exhibit 24, # 25 Exhibit 25, # 26 Exhibit 26, # 27 Exhibit 27, # 28 Exhibit 28, # 29 Exhibit 29, # 30 Exhibit 30, # 31 Exhibit 31, # 32 Exhibit 32, # 33 Exhibit 33, # 34 Exhibit 34, # 35 Exhibit 35, # 36 Exhibit 36, # 37 Exhibit 37, # 38 Exhibit 38, # 39 Exhibit 39, # 40 Exhibit 40, # 41 Exhibit 41, # 42 Exhibit 42, # 43 Exhibit 43, # 44 Errata 44, # 45 Exhibit 45, # 46 Exhibit 46, # 47 Exhibit 47)(Related document(s) 86 ) (Bartlett, Jason) (Filed on 7/1/2011) (Entered: 07/01/2011)
- 07/01/2011 89 Declaration of Sissie Twiggs in Support of 86 MOTION for Preliminary Injunction filed by Apple Inc.. (Attachments: # 1 Exhibit 1, # 2 Exhibit 2, # 3 Exhibit 3, # 4 Exhibit 4, # 5 Exhibit 5, # 6 Exhibit 6, # 7 Exhibit 7, # 8 Exhibit 8, # 9 Exhibit 9, # 10 Exhibit 10, # 11 Exhibit 11, # 12 Exhibit 12, # 13 Exhibit 13, # 14 Exhibit 14, # 15 Exhibit 15, # 16 Exhibit 16, # 17 Exhibit 17, # 18 Exhibit 18, # 19 Exhibit 19, # 20 Exhibit 20)(Related document(s) 86 ) (Bartlett, Jason) (Filed on 7/1/2011) (Entered: 07/01/2011)
- 07/01/2011 90 Declaration of Cooper Woodring in Support of 86 MOTION for Preliminary Injunction filed by Apple Inc.. (Attachments: # 1 Exhibit 1, # 2 Exhibit 2, # 3 Exhibit 3, # 4 Exhibit 4, # 5 Exhibit 5, # 6 Exhibit 6, # 7 Exhibit 7, # 8 Exhibit 8, # 9 Exhibit 9, # 10 Exhibit 10, # 11 Exhibit 11, # 12 Exhibit 12, # 13 Exhibit 13, # 14 Exhibit 14, # 15 Exhibit 15, # 16 Exhibit 16, # 17 Exhibit 17, # 18 Exhibit 18, # 19 Exhibit 19, # 20 Exhibit 20, # 21 Exhibit 21, # 22 Exhibit 22)(Related document(s) 86 ) (Bartlett, Jason) (Filed on 7/1/2011) (Entered: 07/01/2011)
- 07/01/2011 91 Declaration of Ravin Balakrishnan in Support of 86 MOTION for Preliminary Injunction filed by Apple Inc.. (Attachments: # 1 Exhibit 1, # 2 Errata 2, # 3 Exhibit 3, # 4 Exhibit 4, # 5 Exhibit 5, # 6 Exhibit 6, # 7 Exhibit 7, # 8 Exhibit 8, # 9 Exhibit 9, # 10 Exhibit 10, # 11 Exhibit 11, # 12 Exhibit 12, # 13 Exhibit 13a, # 14 Exhibit 13b, # 15 Exhibit 13c, # 16 Exhibit 13d, # 17 Exhibit 13e, # 18 Exhibit 13f, # 19 Exhibit 13g, # 20 Exhibit 13h)(Related document(s) 86 ) (Bartlett, Jason) (Filed on 7/1/2011) (Entered: 07/01/2011)
- 07/01/2011 92 CERTIFICATE OF SERVICE by Apple Inc. re 82 Administrative Motion to File Under Seal in Connection with Motion for A Preliminary Injunction , 88 Declaration in Support,,,, 85 Declaration in Support,, 90 Declaration in Support,, 87 Declaration in Support,,,, 89 Declaration in Support,, 86 MOTION for Preliminary Injunction, 91 Declaration in Support,, 81 MOTION for Leave to File Excess Pages in Connection with Motion for A Preliminary Injunction , 84 MOTION to Shorten Time for Briefing on Apple's Motion for Expedited Trial and Case Management Conference , 83 MOTION to Expedite Trial and Case Management Conference (Bartlett, Jason) (Filed on 7/1/2011) (Entered: 07/01/2011)
- 07/01/2011 93 CERTIFICATE OF SERVICE by Apple Inc. of Declaration of Ravin Balakrishnan, Ph.D. ISO Apple's Mtn for Prelim Injunction (Exhibits 13a-13h) Declaration of Sissie Twiggs ISO Apple's Motion for a Preliminary Injunction (Exhibits 6-10, 19-20) (Bartlett, Jason) (Filed

- on 7/1/2011) (Entered: 07/01/2011)
- 07/01/2011 94 Order by Hon. Lucy H. Koh granting 81 Motion for Leave to File Excess Pages.(lhk1c1, COURT STAFF) (Filed on 7/1/2011) (Entered: 07/01/2011)
- 07/02/2011 95 ORDER Regarding Hearing on Plaintiff's Motion for Preliminary Injunction. Signed by Judge Koh on 7/2/2011. (lhk1c3, COURT STAFF) (Filed on 7/2/2011) (Entered: 07/02/2011)
- 07/05/2011 96 OPPOSITION to ( 84 MOTION to Shorten Time for Briefing on Apple's Motion for Expedited Trial and Case Management Conference ) filed by Samsung Electronics America, Inc., Samsung Electronics Co. Ltd., Samsung Telecommunications America, LLC. (Attachments: # 1 Proposed Order Denying Apple's Motion to Shorten Time)(Maroulis, Victoria) (Filed on 7/5/2011) Modified text on 7/12/2011 (dhm, COURT STAFF). (Entered: 07/05/2011)
- 07/05/2011 97 Declaration of Erik Olson in Support of 96 Opposition/Response to Motion, (Samsung's Opposition to Apple's Motion to Shorten Time) filed by Samsung Electronics America, Inc., Samsung Electronics Co. Ltd., Samsung Telecommunications America, LLC. (Attachments: # 1 Exhibit A)(Related document(s) 96 ) (Maroulis, Victoria) (Filed on 7/5/2011) (Entered: 07/05/2011)
- 07/06/2011 98 REPLY (re 84 MOTION to Shorten Time for Briefing on Apple's Motion for Expedited Trial and Case Management Conference ) filed by Apple Inc.. (Jacobs, Michael) (Filed on 7/6/2011) (Entered: 07/06/2011)
- 07/06/2011 99 CERTIFICATE OF SERVICE by Apple Inc. re 98 Reply to Opposition/Response (Jacobs, Michael) (Filed on 7/6/2011) (Entered: 07/06/2011)
- 07/08/2011 100 Joint Submission Regarding The Briefing and Hearing Schedule Relating to Apple's Motion For Preliminary Injunction re 95 Order, 86 MOTION for Preliminary Injunction filed by Apple Inc., Samsung Electronics America, Inc., Samsung Electronics Co. Ltd., Samsung Telecommunications America, LLC. (Maroulis, Victoria) (Filed on 7/8/2011) Modified on 7/11/2011 document posted in error as a motion (dhm, COURT STAFF). (Entered: 07/08/2011)
- 07/11/2011 101 MOTION to Disqualify Counsel BRIDGES & MAVRAKAKIS LLP filed by Samsung Electronics America, Inc., Samsung Electronics Co. Ltd., Samsung Telecommunications America, LLC. Motion Hearing set for 8/18/2011 01:30 PM in Courtroom 4, 5th Floor, San Jose before Hon. Lucy H. Koh. Responses due by 7/25/2011. Replies due by 8/1/2011. (Maroulis, Victoria) (Filed on 7/11/2011) (Entered: 07/11/2011)
- 07/11/2011 102 Declaration of AUSTIN TARANGO in Support of 101 MOTION to Disqualify Counsel BRIDGES & MAVRAKAKIS LLP filed by Samsung Electronics America, Inc., Samsung Electronics Co. Ltd., Samsung Telecommunications America, LLC. (Attachments: # 1 Exhibit 1, # 2 Exhibit 2, # 3 Exhibit 3, # 4 Exhibit 4, # 5 Exhibit 5, # 6 Exhibit 6, # 7 Exhibit 7, # 8 Exhibit 8, # 9 Exhibit 9, # 10 Exhibit 10, # 11 Exhibit 11)(Related document(s) 101 ) (Maroulis, Victoria) (Filed on 7/11/2011) (Entered: 07/11/2011)
- 07/11/2011 103 Proposed Order re 101 MOTION to Disqualify Counsel BRIDGES & MAVRAKAKIS LLP by Samsung Electronics America, Inc., Samsung Electronics Co. Ltd., Samsung Telecommunications America, LLC. (Maroulis, Victoria) (Filed on 7/11/2011) (Entered: 07/11/2011)
- 07/11/2011 104 Administrative Motion to File Under Seal DECLARATION OF EUNHA KIM ISO MOTION FOR DISQUALIFICATION AND ATTACHED EXHIBITS filed by Samsung Electronics America, Inc., Samsung Electronics Co. Ltd., Samsung Telecommunications America, LLC. (Maroulis, Victoria) (Filed on 7/11/2011) (Entered: 07/11/2011)
- 07/11/2011 105 Declaration in Support of 104 Administrative Motion to File Under Seal DECLARATION OF EUNHA KIM ISO MOTION FOR DISQUALIFICATION AND ATTACHED EXHIBITS filed by Samsung Electronics America, Inc., Samsung Electronics Co. Ltd., Samsung Telecommunications America, LLC. (Related document(s) 104 ) (Maroulis, Victoria) (Filed on 7/11/2011) (Entered: 07/11/2011)
- 07/11/2011 106 Declaration of AUSTIN TARANGO in Support of 104 Administrative Motion to File Under Seal DECLARATION OF EUNHA KIM ISO MOTION FOR DISQUALIFICATION AND ATTACHED EXHIBITS filed by Samsung Electronics America, Inc., Samsung Electronics Co. Ltd., Samsung Telecommunications America, LLC. (Related document(s) 104 ) (Maroulis, Victoria) (Filed on 7/11/2011) (Entered: 07/11/2011)
- 07/11/2011 107 Proposed Order re 104 Administrative Motion to File Under Seal DECLARATION OF EUNHA KIM ISO MOTION FOR DISQUALIFICATION AND ATTACHED EXHIBITS by Samsung Electronics America, Inc., Samsung Electronics Co. Ltd., Samsung

- Telecommunications America, LLC. (Maroulis, Victoria) (Filed on 7/11/2011) (Entered: 07/11/2011)
- 07/11/2011 108 CERTIFICATE OF SERVICE by Samsung Electronics America, Inc., Samsung Electronics Co. Ltd., Samsung Telecommunications America, LLC re 104 Administrative Motion to File Under Seal DECLARATION OF EUNHA KIM ISO MOTION FOR DISQUALIFICATION AND ATTACHED EXHIBITS (Maroulis, Victoria) (Filed on 7/11/2011) (Entered: 07/11/2011)
- 07/12/2011 109 Transcript of Proceedings held on 05-12-11, before Judge Lucy H. Koh. Court Reporter/Transcriber Lee-Anne Shortridge, Telephone number 408-287-4580. Per General Order No. 59 and Judicial Conference policy, this transcript may be viewed only at the Clerks Office public terminal or may be purchased through the Court Reporter/Transcriber until the deadline for the Release of Transcript Restriction. After that date it may be obtained through PACER. Any Notice of Intent to Request Redaction, if required, is due no later than 5 business days from date of this filing. Release of Transcript Restriction set for 10/11/2011. (las, ) (Filed on 7/12/2011) (Entered: 07/12/2011)
- 07/12/2011 110 ORDER Denying 84 MOTION to Shorten Time for Briefing on Apple's Motion for Expedited Trial and Case Management Conference. Signed by Judge Koh on 7/12/2011. (lhkic1, COURT STAFF) (Filed on 7/12/2011) (Entered: 07/12/2011)
- 07/15/2011 111 OPPOSITION to ( 83 MOTION to Expedite Trial and Case Management Conference ) filed by Samsung Electronics America, Inc., Samsung Electronics Co. Ltd., Samsung Telecommunications America, LLC. (Maroulis, Victoria) (Filed on 7/15/2011) Modified text on 7/20/2011 (dhm, COURT STAFF). (Entered: 07/15/2011)
- 07/15/2011 112 DECLARATION of AUSTIN TARANGO IN SUPPORT OF 111 SAMSUNG'S OPPOSITION TO APPLE'S MOTION FOR EXPEDITED TRIAL ON ITS CLAIMS AND FOR EARLY CASE MANAGEMENT CONFERENCE filed by Samsung Electronics America, Inc., Samsung Electronics Co. Ltd., Samsung Telecommunications America, LLC. (Attachments: # 1 Exhibit 1, # 2 Exhibit 2, # 3 Exhibit 3, # 4 Exhibit 4, # 5 Exhibit 5, # 6 Exhibit 6, # 7 Exhibit 7, # 8 Exhibit 8, # 9 Exhibit 9)(Maroulis, Victoria) (Filed on 7/15/2011) Modified on 7/20/2011 counsel failed to link entry to document #111 (dhm, COURT STAFF). (Entered: 07/15/2011)
- 07/15/2011 113 Proposed Order re 111 regarding APPLE'S MOTION FOR EXPEDITED TRIAL ON ITS CLAIMS AND FOR EARLY CASE MANAGEMENT CONFERENCE by Samsung Electronics America, Inc., Samsung Electronics Co. Ltd., Samsung Telecommunications America, LLC. (Maroulis, Victoria) (Filed on 7/15/2011) Modified on 7/20/2011 (dhm, COURT STAFF). (Entered: 07/15/2011)
- 07/18/2011 114 NOTICE of Appearance by Mark Daniel Selwyn (Selwyn, Mark) (Filed on 7/18/2011) (Entered: 07/18/2011)
- 07/18/2011 115 ORDER SETTING BRIEFING AND HEARING SCHEDULE FOR 86 MOTION for Preliminary Injunction. Motion Hearing set for 10/13/2011 01:30 PM in Courtroom 8, 4th Floor, San Jose before Hon. Lucy H. Koh. Signed by Judge Koh on 7/18/2011. (lhkic1, COURT STAFF) (Filed on 7/18/2011) (Entered: 07/18/2011)
- 07/19/2011 116 CLERKS NOTICE Continuing Motion Hearing, Set/Reset Deadlines as to 101 MOTION to Disqualify Counsel BRIDGES & MAVRAKAKIS LLP . Motion Hearing set for 8/24/2011 02:00 PM in Courtroom 8, 4th Floor, San Jose before Hon. Lucy H. Koh. (mpb, COURT STAFF) (Filed on 7/19/2011) (Entered: 07/19/2011)
- 07/19/2011 117 APPLICATION of William F. Lee for Admission Pro Hac Vice ( Filing fee \$ 275, receipt number 54611010069) filed by Apple Inc. (dhm, COURT STAFF) (Filed on 7/19/2011) (Entered: 07/20/2011)
- 07/19/2011 118 Proposed Order re 117 APPLICATION of William F. Lee for Admission Pro Hac Vice ( Filing fee \$ 275, receipt number 54611010069) by Apple Inc.. (dhm, COURT STAFF) (Filed on 7/19/2011) (Entered: 07/20/2011)
- 07/20/2011 119 STIPULATION Joint Stipulation and [Proposed] Order Regarding Extension of Time by Apple Inc.. (Pieja, Michael) (Filed on 7/20/2011) (Entered: 07/20/2011)
- 07/20/2011 120 Declaration of Michael T. Pieja in Support of 119 Stipulation Joint Stipulation and [Proposed] Order Regarding Extension of Time filed by Apple Inc.. (Related document(s) 119 ) (Pieja, Michael) (Filed on 7/20/2011) (Entered: 07/20/2011)
- 07/20/2011 121 NOTICE of Appearance by Stephen E. Taylor (Taylor, Stephen) (Filed on 7/20/2011) (Entered: 07/20/2011)
- 07/20/2011 122 NOTICE of Appearance by Joshua Ryan Benson (Benson, Joshua) (Filed on 7/20/2011) (Entered: 07/20/2011)

- 07/20/2011 123 Order by Hon. Lucy H. Koh granting 117 APPLICATION of William F. Lee for Admission Pro Hac Vice.(lhkic1, COURT STAFF) (Filed on 7/20/2011) (Entered: 07/20/2011)
- 07/21/2011 124 ANSWER TO COUNTERCLAIM 80 Answer to Amended Complaint,,, Counterclaim,,, Counterclaim Defendant Apple Inc.'s , First COUNTERCLAIM in Reply against Samsung Electronics America, Inc., Samsung Electronics Co. Ltd., Samsung Telecommunications America, LLC byApple Inc.. (Selwyn, Mark) (Filed on 7/21/2011) (Entered: 07/21/2011)
- 07/21/2011 125 STIPULATION AND ORDER re 119 Extending Time for Briefing of Samsung's Motion to Disqualify. Signed by Judge Koh on 7/21/2011. (lhkic1, COURT STAFF) (Filed on 7/21/2011) (Entered: 07/21/2011)
- 07/21/2011 126 Order by Hon. Lucy H. Koh granting 82 Administrative Motion to File Under Seal.(lhkic1, COURT STAFF) (Filed on 7/21/2011) (Entered: 07/21/2011)
- 07/21/2011 127 Order by Hon. Lucy H. Koh granting 104 Administrative Motion to File Under Seal.(lhkic1, COURT STAFF) (Filed on 7/21/2011) (Entered: 07/21/2011)
- 07/21/2011 128 DOCUMENT E-FILED UNDER SEAL re 126 Order on Administrative Motion to File Under Seal Declaration of Richard J. Lutton, Jr. in Support of Apple's Motion for a Preliminary Injunction by Apple Inc.. (Bartlett, Jason) (Filed on 7/21/2011) (Entered: 07/21/2011)
- 07/21/2011 129 Declaration of Richard J. Lutton in Support of 86 MOTION for Preliminary Injunction filed byApple Inc.. (Related document(s) 86 ) (Bartlett, Jason) (Filed on 7/21/2011) (Entered: 07/21/2011)
- 07/22/2011 130 DOCUMENT E-FILED UNDER SEAL re 127 Order on Administrative Motion to File Under Seal DECLARATION OF EUNHA KIM IN SUPPORT OF SAMSUNG'S MOTION TO DISQUALIFY BRIDGES & MAVRAKAKIS LLP by Samsung Electronics America, Inc., Samsung Electronics Co. Ltd., Samsung Telecommunications America, LLC. (Attachments: # 1 Exhibit 1, # 2 Exhibit 2, # 3 Exhibit 3)(Maroulis, Victoria) (Filed on 7/22/2011) (Entered: 07/22/2011)
- 07/22/2011 131 REPLY (re 83 MOTION to Expedite Trial and Case Management Conference ) filed byApple Inc.. (Jacobs, Michael) (Filed on 7/22/2011) (Entered: 07/22/2011)
- 08/01/2011 132 Administrative Motion to File Under Seal Documents in Support of Opposition to Defendants' Motion to Disqualify Bridges & Mavrakakis, LLP filed by Apple Inc.. (Attachments: # 1 Declaration of Joshua R. Benson in Support of Motion to Seal, # 2 Proposed Order Granting Motion to Seal)(Benson, Joshua) (Filed on 8/1/2011) (Entered: 08/01/2011)
- 08/01/2011 133 OPPOSITION to ( 101 MOTION to Disqualify Counsel BRIDGES & MAVRAKAKIS LLP ) filed by Apple Inc.. (Taylor, Stephen) (Filed on 8/1/2011) Modified text on 8/4/2011 (dhm, COURT STAFF). (Entered: 08/01/2011)
- 08/01/2011 134 Declaration of Kenneth H. Bridges in Support of 133 Opposition/Response to Motion to Disqualify Bridges & Mavrakakis, LLP filed byApple Inc.. (Related document(s) 133 ) (Taylor, Stephen) (Filed on 8/1/2011) (Entered: 08/01/2011)
- 08/01/2011 135 Declaration of Thomas C. Mavrakakis in Support of 133 Opposition/Response to Motion to Disqualify Bridges & Mavrakakis, LLP filed byApple Inc.. (Related document(s) 133 ) (Taylor, Stephen) (Filed on 8/1/2011) (Entered: 08/01/2011)
- 08/01/2011 136 Declaration of Michael T. Pieja in Support of 133 Opposition/Response to Motion to Disqualify Bridges & Mavrakakis, LLP filed byApple Inc.. (Related document(s) 133 ) (Taylor, Stephen) (Filed on 8/1/2011) (Entered: 08/01/2011)
- 08/01/2011 137 Declaration of James A. Shimota in Support of 133 Opposition/Response to Motion to Disqualify Bridges & Mavrakakis, LLP filed byApple Inc.. (Related document(s) 133 ) (Taylor, Stephen) (Filed on 8/1/2011) (Entered: 08/01/2011)
- 08/01/2011 138 Declaration of Howard E. Levin in Support of 133 Opposition/Response to Motion to Disqualify Bridges & Mavrakakis, LLP filed byApple Inc.. (Related document(s) 133 ) (Taylor, Stephen) (Filed on 8/1/2011) (Entered: 08/01/2011)
- 08/01/2011 139 Declaration of Christopher Lubeck in Support of 133 Opposition/Response to Motion to Disqualify Bridges & Mavrakakis, LLP filed byApple Inc.. (Related document(s) 133 ) (Taylor, Stephen) (Filed on 8/1/2011) (Entered: 08/01/2011)
- 08/01/2011 140 Declaration of Brian C. Kwok in Support of 133 Opposition/Response to Motion to Disqualify Bridges & Mavrakakis, LLP filed byApple Inc.. (Related document(s) 133 ) (Taylor, Stephen) (Filed on 8/1/2011) (Entered: 08/01/2011)
- 08/01/2011 141 Declaration of John Steele in Support of 133 Opposition/Response to Motion to Disqualify Bridges & Mavrakakis, LLP filed byApple Inc.. (Attachments: # 1 Exhibit A)(Related

- document(s) 133 ) (Taylor, Stephen) (Filed on 8/1/2011) (Entered: 08/01/2011)
- 08/01/2011 142 Declaration of Jayna R. Whitt in Support of 133 Opposition/Response to Motion to Disqualify Bridges & Mavrakakis, LLP filed by Apple Inc.. (Related document(s) 133 ) (Taylor, Stephen) (Filed on 8/1/2011) (Entered: 08/01/2011)
- 08/01/2011 143 Declaration of Michael A. Jacobs in Support of 133 Opposition/Response to Motion to Disqualify Bridges & Mavrakakis, LLP filed by Apple Inc.. (Related document(s) 133 ) (Taylor, Stephen) (Filed on 8/1/2011) (Entered: 08/01/2011)
- 08/01/2011 144 Declaration of Mark D. Selwyn in Support of 133 Opposition/Response to Motion to Disqualify Bridges & Mavrakakis, LLP filed by Apple Inc.. (Related document(s) 133 ) (Taylor, Stephen) (Filed on 8/1/2011) (Entered: 08/01/2011)
- 08/01/2011 145 CERTIFICATE OF SERVICE by Apple Inc. re 134 Declaration, 135 Declaration, 136 Declaration in Support of Opposition to Defendants' Motion to Disqualify Bridges & Mavrakakis, LLP (Taylor, Stephen) (Filed on 8/1/2011) Modified on 8/4/2011 linking entry to document #134, 135, 136 (dhm, COURT STAFF). (Entered: 08/01/2011)
- 08/08/2011 146 STIPULATION re 115 Order,, Set Deadlines/Hearings, Stipulation and Proposed Order Extending Deadline by Samsung Electronics America, Inc., Samsung Electronics Co. Ltd., Samsung Telecommunications America, LLC. (Attachments: # 1 Declaration)(Maroulis, Victoria) (Filed on 8/8/2011) (Entered: 08/08/2011)
- 08/08/2011 147 Administrative Motion to File Under Seal filed by Samsung Electronics America, Inc., Samsung Electronics Co. Ltd., Samsung Telecommunications America, LLC. (Maroulis, Victoria) (Filed on 8/8/2011) (Entered: 08/08/2011)
- 08/08/2011 148 Declaration of Austin Tarango in Support of 147 Administrative Motion to File Under Seal filed by Samsung Electronics America, Inc., Samsung Electronics Co. Ltd., Samsung Telecommunications America, LLC. (Related document(s) 147 ) (Maroulis, Victoria) (Filed on 8/8/2011) (Entered: 08/08/2011)
- 08/08/2011 149 Proposed Order re 147 Administrative Motion to File Under Seal by Samsung Electronics America, Inc., Samsung Electronics Co. Ltd., Samsung Telecommunications America, LLC. (Maroulis, Victoria) (Filed on 8/8/2011) (Entered: 08/08/2011)
- 08/08/2011 150 Declaration of Austin Tarango in Support of Reply in Support of 101 MOTION TO DISQUALIFY BRIDGES & MAVRAKAKIS, LLP filed by Samsung Electronics America, Inc., Samsung Electronics Co. Ltd., Samsung Telecommunications America, LLC. (Attachments: # 1 Exhibit A, # 2 Exhibit B, # 3 Exhibit C, # 4 Exhibit D, # 5 Exhibit E) (Maroulis, Victoria) (Filed on 8/8/2011) Modified on 8/10/2011 counsel failed to link entry to related document (dhm, COURT STAFF). (Entered: 08/08/2011)
- 08/08/2011 151 CERTIFICATE OF SERVICE by Samsung Electronics America, Inc., Samsung Electronics Co. Ltd., Samsung Telecommunications America, LLC SAMSUNG'S REPLY IN SUPPORT OF ITS MOTION TO DISQUALIFY BRIDGES & MAVRAKAKIS, LLP (Maroulis, Victoria) (Filed on 8/8/2011) (Entered: 08/08/2011)
- 08/10/2011 152 ORDER Approving Stipulated Extension of Discovery re 146 STIPULATION re 115 Order. Signed by Judge Lucy H. Koh on 8/10/2011. (lhkic2, COURT STAFF) (Filed on 8/10/2011) Modified text to create linkage on 8/24/2011 (ecg, COURT STAFF). (Entered: 08/10/2011)
- 08/15/2011 153 MOTION to Dismiss and MOTION to Strike Apple's Counterclaims filed by Samsung Electronics America, Inc., Samsung Electronics Co. Ltd., Samsung Telecommunications America, LLC. Motion Hearing set for 9/22/2011 01:30 PM in Courtroom 4, 5th Floor, San Jose before Hon. Lucy H. Koh. Responses due by 8/29/2011. Replies due by 9/6/2011. (Maroulis, Victoria) (Filed on 8/15/2011) Modified on 8/27/2011 counsel failed to select multiple motion event types (dhm, COURT STAFF). (Entered: 08/15/2011)
- 08/15/2011 154 Proposed Order re 153 MOTION to Dismiss and Strike Apple's Counterclaims by Samsung Electronics America, Inc., Samsung Electronics Co. Ltd., Samsung Telecommunications America, LLC. (Maroulis, Victoria) (Filed on 8/15/2011) Modified text on 8/27/2011 (dhm, COURT STAFF). (Entered: 08/15/2011)
- 08/16/2011 155 MOTION for Leave to File (Apple Inc.'s Administrative Motion for Leave to File Sur-Reply in Opposition to (Document No. 101) Samsung's Motion to Disqualify Bridges & Mavrakakis LLP) filed by Apple Inc.. (Attachments: # 1 Exhibit 1, # 2 Declaration) (Benson, Joshua) (Filed on 8/16/2011) (Entered: 08/16/2011)
- 08/16/2011 156 STIPULATION re 155 MOTION for Leave to File (Apple Inc.'s Administrative Motion for Leave to File Sur-Reply in Opposition to (Document No. 101) Samsung's Motion to Disqualify Bridges & Mavrakakis LLP) MOTION for Leave to File (Apple Inc.'s Administrative Motion for Leave to File Sur-Reply in Opposition to (Document No. 101)

- Samsung's Motion to Disqualify Bridges & Mavrakakis LLP) , 101 MOTION to Disqualify Counsel BRIDGES & MAVRAKAKIS LLP (Stipulation and [Proposed] Order Granting Apple Inc. Leave to File Sur-Reply in Opposition to Samsung's Motion to Disqualify) by Apple Inc.. (Benson, Joshua) (Filed on 8/16/2011) (Entered: 08/16/2011)
- 08/18/2011 157 JOINT CASE MANAGEMENT STATEMENT filed by Apple Inc., Samsung Electronics America, Inc., Samsung Electronics Co. Ltd., Samsung Telecommunications America, LLC. (Maroulis, Victoria) (Filed on 8/18/2011) (Entered: 08/18/2011)
- 08/19/2011 158 ORDER by Judge Lucy H. Koh granting 155 Motion for Leave to File (lhklc2, COURT STAFF) (Filed on 8/19/2011) (Entered: 08/19/2011)
- 08/19/2011 159 JOINT CASE MANAGEMENT STATEMENT CORRECTED filed by Apple Inc., Samsung Electronics America, Inc., Samsung Electronics Co. Ltd., Samsung Telecommunications America, LLC. (Maroulis, Victoria) (Filed on 8/19/2011) (Entered: 08/19/2011)
- 08/22/2011 160 NOTICE of Appearance by Stephen McGeorge Bundy (Bundy, Stephen) (Filed on 8/22/2011) (Entered: 08/22/2011)
- 08/22/2011 161 NOTICE of Appearance by Margret Mary Caruso (Caruso, Margret) (Filed on 8/22/2011) (Entered: 08/22/2011)
- 08/22/2011 162 NOTICE of Appearance by Todd Michael Briggs (Briggs, Todd) (Filed on 8/22/2011) (Entered: 08/22/2011)
- 08/22/2011 163 MOTION for Leave to File Excess Pages FOR SAMSUNG'S OPPOSITION TO APPLE'S MOTION FOR PRELIMINARY INJUNCTION filed by Samsung Electronics America, Inc., Samsung Electronics Co. Ltd., Samsung Telecommunications America, LLC. (Maroulis, Victoria) (Filed on 8/22/2011) (Entered: 08/22/2011)
- 08/22/2011 164 STIPULATION re 163 MOTION for Leave to File Excess Pages FOR SAMSUNG'S OPPOSITION TO APPLE'S MOTION FOR PRELIMINARY INJUNCTION AND PROPOSED ORDER by Samsung Electronics America, Inc., Samsung Electronics Co. Ltd., Samsung Telecommunications America, LLC. (Maroulis, Victoria) (Filed on 8/22/2011) (Entered: 08/22/2011)
- 08/22/2011 165 Declaration of BENJAMIN B. BEDERSON IN SUPPORT OF SAMSUNG'S OPPOSITION TO APPLE'S MOTION FOR PRELIMINARY INJUNCTION filed by Samsung Electronics America, Inc., Samsung Electronics Co. Ltd., Samsung Telecommunications America, LLC. (Attachments: # 1 Exhibit A, # 2 Exhibit B, # 3 Exhibit C, # 4 Exhibit D, # 5 Exhibit E, # 6 Exhibit F, # 7 Exhibit G, # 8 Exhibit H, # 9 Exhibit I, # 10 Exhibit J, # 11 Exhibit K, # 12 Exhibit L, # 13 Exhibit M)(Maroulis, Victoria) (Filed on 8/22/2011) Modified on 8/29/2011 cannot link entry-opposition has not been efiled (dhm, COURT STAFF). (Entered: 08/22/2011)
- 08/22/2011 166 Declaration of ROGER FIDLER IN SUPPORT OF SAMSUNG'S OPPOSITION TO APPLE'S MOTION FOR PRELIMINARY INJUNCTION filed by Samsung Electronics America, Inc., Samsung Electronics Co. Ltd., Samsung Telecommunications America, LLC. (Attachments: # 1 Exhibit A, # 2 Exhibit B, # 3 Exhibit C, # 4 Exhibit D, # 5 Exhibit E, # 6 Exhibit F, # 7 Exhibit G, # 8 Exhibit H, # 9 Exhibit I, # 10 Exhibit J, # 11 Exhibit K, # 12 Exhibit L, # 13 Exhibit M, # 14 Exhibit N, # 15 Exhibit O, # 16 Exhibit P, # 17 Exhibit Q)(Maroulis, Victoria) (Filed on 8/22/2011) Modified on 8/29/2011 cannot link entry-opposition has not been efiled (dhm, COURT STAFF). (Entered: 08/22/2011)
- 08/22/2011 167 Declaration of NICHOLAS P. GODICI IN SUPPORT OF SAMSUNG'S OPPOSITION TO APPLE'S MOTION FOR PRELIMINARY INJUNCTION filed by Samsung Electronics America, Inc., Samsung Electronics Co. Ltd., Samsung Telecommunications America, LLC. (Attachments: # 1 Exhibit 1, # 2 Exhibit 2, # 3 Exhibit 3, # 4 Exhibit 4-1, # 5 Exhibit 4-2, # 6 Exhibit 5, # 7 Exhibit 6, # 8 Exhibit 7, # 9 Exhibit 8-1, # 10 Exhibit 8-2, # 11 Exhibit 8-3, # 12 Exhibit 8-4, # 13 Exhibit 8-5, # 14 Exhibit 8-6, # 15 Exhibit 8-7, # 16 Exhibit 9, # 17 Exhibit 10, # 18 Exhibit 11, # 19 Exhibit 12-1, # 20 Exhibit 12-2, # 21 Exhibit 12-3, # 22 Exhibit 12-4, # 23 Exhibit 13, # 24 Exhibit 14)(Maroulis, Victoria) (Filed on 8/22/2011) Modified on 8/29/2011 cannot link entry-opposition has not been efiled (dhm, COURT STAFF). (Entered: 08/22/2011)
- 08/22/2011 168 Declaration of ANDRIES VAN DAM, PH.D IN SUPPORT OF SAMSUNG'S OPPOSITION TO APPLE'S MOTION FOR PRELIMINARY INJUNCTION filed by Samsung Electronics America, Inc., Samsung Electronics Co. Ltd., Samsung Telecommunications America, LLC. (Attachments: # 1 Exhibit 1, # 2 Exhibit 2, # 3 Exhibit 3, # 4 Exhibit 4, # 5 Exhibit 5, # 6 Exhibit 6, # 7 Exhibit 7, # 8 Exhibit 8, # 9 Exhibit 9, # 10 Exhibit 10, # 11 Exhibit 11, # 12 Exhibit 12, # 13 Exhibit 13, # 14 Exhibit 14)(Maroulis, Victoria) (Filed on 8/22/2011) Modified on 8/29/2011 cannot link entry-opposition has not been efiled (dhm, COURT STAFF). (Entered: 08/22/2011)

- 08/22/2011 169 Administrative Motion to File Under Seal filed by Samsung Electronics America, Inc., Samsung Electronics Co. Ltd., Samsung Telecommunications America, LLC. (Johnson, Kevin) (Filed on 8/22/2011) (Entered: 08/22/2011)
- 08/22/2011 170 Declaration of MELISSA N. CHAN in Support of 169 Administrative Motion to File Under Seal filed by Samsung Electronics America, Inc., Samsung Electronics Co. Ltd., Samsung Telecommunications America, LLC. (Related document(s) 169 ) (Johnson, Kevin) (Filed on 8/22/2011) (Entered: 08/22/2011)
- 08/22/2011 171 Proposed Order re 169 Administrative Motion to File Under Seal by Samsung Electronics America, Inc., Samsung Electronics Co. Ltd., Samsung Telecommunications America, LLC. (Johnson, Kevin) (Filed on 8/22/2011) (Entered: 08/22/2011)
- 08/22/2011 172 Declaration of ITAY SHERMAN IN SUPPORT OF SAMSUNG'S OPPOSITION TO APPLE'S MOTION FOR PRELIMINARY INJUNCTION filed by Samsung Electronics America, Inc., Samsung Electronics Co. Ltd., Samsung Telecommunications America, LLC. (Attachments: # 1 Exhibit A, # 2 Exhibit B, # 3 Exhibit C, # 4 Exhibit D, # 5 Exhibit E, # 6 Exhibit F, # 7 Exhibit G, # 8 Exhibit H, # 9 Exhibit I, # 10 Exhibit J, # 11 Exhibit K, # 12 Exhibit L, # 13 Exhibit M, # 14 Exhibit N, # 15 Exhibit O, # 16 Exhibit P, # 17 Exhibit Q, # 18 Exhibit R, # 19 Exhibit S, # 20 Exhibit T, # 21 Exhibit U, # 22 Exhibit V, # 23 Exhibit W, # 24 Exhibit X, # 25 Exhibit Y, # 26 Exhibit Z, # 27 Exhibit AA, # 28 Exhibit BB, # 29 Exhibit CC, # 30 Exhibit DD, # 31 Exhibit EE, # 32 Exhibit FF, # 33 Exhibit GG, # 34 Exhibit HH)(Maroulis, Victoria) (Filed on 8/22/2011) Modified on 8/29/2011 cannot link entry-opposition has not been efiled (dhm, COURT STAFF). (Entered: 08/22/2011)
- 08/22/2011 173 Declaration of MICHAEL J. WAGNER IN SUPPORT OF SAMSUNG'S OPPOSITION TO APPLE'S MOTION FOR PRELIMINARY INJUNCTION filed by Samsung Electronics America, Inc., Samsung Electronics Co. Ltd., Samsung Telecommunications America, LLC. (Attachments: # 1 Exhibit A, # 2 Exhibit B, # 3 Exhibit C, # 4 Exhibit D, # 5 Exhibit E) (Maroulis, Victoria) (Filed on 8/22/2011) Modified on 8/29/2011 Document posted does not comply with General Order No. 62. Cannot link-opposition not efiled (dhm, COURT STAFF). (Entered: 08/22/2011)
- 08/22/2011 174 Declaration of JEFFREY JOHNSON, PH.D. IN SUPPORT OF SAMSUNG'S OPPOSITION TO APPLE'S MOTION FOR PRELIMINARY INJUNCTION filed by Samsung Electronics America, Inc., Samsung Electronics Co. Ltd., Samsung Telecommunications America, LLC. (Attachments: # 1 Exhibit 1, # 2 Exhibit 2, # 3 Exhibit 3)(Maroulis, Victoria) (Filed on 8/22/2011) Modified on 8/29/2011 Document posted does not comply with General Order No. 62 . Cannot link entry-opposition not efiled (dhm, COURT STAFF). Modified on 8/29/2011 (dhm, COURT STAFF). (Entered: 08/22/2011)
- 08/22/2011 175 Administrative Motion to File Under Seal SAMSUNG'S OPPOSITION TO APPLE'S MOTION FOR PRELIMINARY INJUNCTION filed by Samsung Electronics America, Inc., Samsung Electronics Co. Ltd., Samsung Telecommunications America, LLC. (Attachments: # 1 STIPULATED ADMINISTRATIVE MOTION TO FILE UNDER SEAL PURSUANT TO CIVIL LOCAL RULES 7-11 AND 79-5 \*\*\* FOR CORRECT ATTACHMENT REFER TO DOCUMENT 186 . \*\*\* # 2 Proposed Order)(Maroulis, Victoria) (Filed on 8/22/2011) Modified on 8/25/2011 (feriab, COURT STAFF). Modified on 10/18/2011 (cv, COURT STAFF). (Entered: 08/22/2011)
- 08/23/2011 176 MOTION SAMSUNG'S NOTICE OF MOTION AND MOTION TO EXCLUDE ORDINARY OBSERVER OPINIONS OF APPLE EXPERT COOPER WOODRING; AND MEMORANDUM OF POINTS AND AUTHORITIES IN SUPPORT FILED UNDER SEAL filed by Samsung Electronics America, Inc., Samsung Electronics Co. Ltd., Samsung Telecommunications America, LLC. Motion Hearing set for 10/13/2011 01:30 PM in Courtroom 8, 4th Floor, San Jose before Hon. Lucy H. Koh. Responses due by 9/6/2011. Replies due by 9/13/2011. (Johnson, Kevin) (Filed on 8/23/2011) Modified on 8/29/2011 DOCUMENT POSTED IS NOT IN COMPLIANCE WITH GENERAL ORDER NO. 62 (dhm, COURT STAFF). (Entered: 08/23/2011)
- 08/23/2011 177 Declaration of MICHAEL ZELLER IN SUPPORT OF 176 MOTION TO EXCLUDE ORDINARY OBSERVER OPINIONS OF APPLE EXPERT COOPER WOODRING filed by Samsung Electronics America, Inc., Samsung Electronics Co. Ltd., Samsung Telecommunications America, LLC. (Attachments: # 1 Exhibit 1, # 2 Exhibit 2, # 3 Exhibit 3, # 4 Exhibit 4, # 5 Exhibit 5, # 6 Exhibit 6, # 7 Exhibit 7, # 8 Exhibit 8)(Johnson, Kevin) (Filed on 8/23/2011) Modified on 8/29/2011 linking entry to document #176 (dhm, COURT STAFF). (Entered: 08/23/2011)
- 08/23/2011 178 Proposed Order re 176 MOTION SAMSUNG'S NOTICE OF MOTION AND MOTION TO EXCLUDE ORDINARY OBSERVER OPINIONS OF APPLE EXPERT COOPER WOODRING; AND MEMORANDUM OF POINTS AND AUTHORITIES IN SUPPORT FILED UNDER SEAL by Samsung Electronics America, Inc., Samsung Electronics Co. Ltd., Samsung

- Telecommunications America, LLC. (Johnson, Kevin) (Filed on 8/23/2011) (Entered: 08/23/2011)
- 08/23/2011 179 Declaration of SARA JENKINS IN SUPPORT OF SAMSUNG'S OPPOSITION TO APPLE'S MOTION FOR PRELIMINARY INJUNCTION filed by Samsung Electronics America, Inc., Samsung Electronics Co. Ltd., Samsung Telecommunications America, LLC. (Attachments: # 1 Exhibit A, # 2 Exhibit B, # 3 Exhibit C, # 4 Exhibit D, # 5 Exhibit E, # 6 Exhibit F, # 7 Exhibit G, # 8 Exhibit H, # 9 Exhibit I, # 10 Exhibit J, # 11 Exhibit K, # 12 Exhibit L, # 13 Exhibit M, # 14 Exhibit N, # 15 Exhibit O, # 16 Exhibit P, # 17 Exhibit Q, # 18 Exhibit R, # 19 Exhibit S, # 20 Exhibit T, # 21 Exhibit U, # 22 Exhibit V, # 23 Exhibit W, # 24 Exhibit X, # 25 Exhibit Y, # 26 Exhibit Z, # 27 Exhibit AA, # 28 Exhibit BB, # 29 Exhibit CC, # 30 Exhibit DD, # 31 Exhibit EE, # 32 Exhibit FF, # 33 Exhibit GG, # 34 Exhibit HH, # 35 Exhibit II, # 36 Exhibit JJ, # 37 Exhibit KK, # 38 Exhibit LL, # 39 Exhibit MM, # 40 Exhibit NN, # 41 Exhibit OO, # 42 Exhibit PP, # 43 Exhibit QQ, # 44 Exhibit RR, # 45 Exhibit SS, # 46 Exhibit TT)(Maroulis, Victoria) (Filed on 8/23/2011) Modified on 8/29/2011 cannot link entry-opposition has not been efiled (dhm, COURT STAFF). (Entered: 08/23/2011)
- 08/23/2011 180 Proposed Order DENYING APPLE'S MOTION FOR PRELIMINARY INJUNCTION by Samsung Electronics America, Inc., Samsung Electronics Co. Ltd., Samsung Telecommunications America, LLC. (Maroulis, Victoria) (Filed on 8/23/2011) (Entered: 08/23/2011)
- 08/23/2011 181 CERTIFICATE OF SERVICE by Samsung Electronics America, Inc., Samsung Electronics Co. Ltd., Samsung Telecommunications America, LLC OF SAMSUNG'S OPPOSITION TO APPLE'S MOTION FOR PRELIMINARY INJUNCTION (Maroulis, Victoria) (Filed on 8/23/2011) (Entered: 08/23/2011)
- 08/23/2011 182 NOTICE of Appearance by Kathleen Marie Sullivan on behalf of SAMSUNG ELECTRONICS CO., LTD., et al. (Sullivan, Kathleen) (Filed on 8/23/2011) (Entered: 08/23/2011)
- 08/23/2011 183 CERTIFICATE OF SERVICE by Samsung Electronics America, Inc., Samsung Electronics Co. Ltd., Samsung Telecommunications America, LLC (Maroulis, Victoria) (Filed on 8/23/2011) Modified on 8/29/2011 linking entry to document #176 and #177 (dhm, COURT STAFF). (Entered: 08/23/2011)
- 08/24/2011 184 Minute Entry: Motion Hearing held on 8/24/2011 before Judge Lucy H. Koh (Date Filed: 8/24/2011) re 83 MOTION to Expedite Trial and Case Management Conference filed by Apple Inc., 101 MOTION to Disqualify Counsel BRIDGES & MAVRAKAKIS LLP filed by Samsung Electronics Co. Ltd., Samsung Telecommunications America, LLC, Samsung Electronics America, Inc. The Court took the matter under submission. The Court to issue further Order following hearing. (Court Reporter Lee-Anne Shortridge.) (ecg, COURT STAFF) (Date Filed: 8/24/2011) (Entered: 08/25/2011)
- 08/25/2011 185 Letter from Stephen E. Taylor. (Taylor, Stephen) (Filed on 8/25/2011) (Entered: 08/25/2011)
- 08/25/2011 186 Declaration of MELISSA CHAN IN SUPPORT OF 175 SAMSUNG'S STIPULATED ADMINISTRATIVE MOTION TO FILE UNDER SEAL - CORRECTION OF DOCKET filed by Samsung Electronics America, Inc., Samsung Electronics Co. Ltd., Samsung Telecommunications America, LLC. (Maroulis, Victoria) (Filed on 8/25/2011) Modified on 8/31/2011 linking entry to document #175 (dhm, COURT STAFF). (Entered: 08/25/2011)
- 08/25/2011 187 Minute Entry: Further Case Management Conference held on 8/24/2011 before Judge Lucy H. Koh (Date Filed: 8/25/2011). Amended Pleadings due by 11/14/2011. Close of Claim Construction Discovery due by 11/28/2011. Close of Fact Discovery due by 3/8/2012, Close of Expert Discovery due by 4/27/2012. Last Date to File Dispositive Motions due by 5/17/2012. Date for Hearing Dispositive Motions set for 6/21/2012 09:00 AM in Courtroom 8, 4th Floor, San Jose before Hon. Lucy H. Koh. Tutorial Hearing set for 1/17/2012 01:30 PM - 4:30 PM in Courtroom 8, 4th Floor, San Jose. Claims Construction Hearing set for 1/20/2012 10:00 AM - 12:00 PM, 01:00 PM - 3:00 PM. Final Pretrial Conference set for 7/18/2012 02:00 PM in Courtroom 8, 4th Floor, San Jose. Jury Trial set for 7/30/2012 09:00 AM in Courtroom 8, 4th Floor, San Jose before Hon. Lucy H. Koh. Please see Order for further specifics. (Court Reporter Lee-Anne Shortridge.) (ecg, COURT STAFF) (Date Filed: 8/25/2011) (Entered: 08/25/2011)
- 08/25/2011 188 NOTICE by Apple Inc. of Withdrawal of Bridges & Mavrakakis LLP (Bridges, Kenneth) (Filed on 8/25/2011) (Entered: 08/25/2011)
- 08/29/2011 189 OPPOSITION (re 153 MOTION to Dismiss and MOTION to Strike Apple's Counterclaims ) filed by Apple Inc.. (Attachments: # 1 Proposed Order)(Selwyn, Mark) (Filed on 8/29/2011) Modified text on 9/1/2011 (dhm, COURT STAFF). (Entered: 08/29/2011)



- 08/29/2011 190 Declaration of Mark D. Selwyn in Support of 189 Opposition/Response to Motion to Dismiss and Strike Apple's Counterclaims filed by Apple Inc.. (Attachments: # 1 Exhibit A, # 2 Exhibit B, # 3 Exhibit C, # 4 Exhibit D, # 5 Exhibit E, # 6 Exhibit F, # 7 Exhibit G) (Related document(s) 189 ) (Selwyn, Mark) (Filed on 8/29/2011) (Entered: 08/29/2011)
- 08/30/2011 191 ORDER Directing Defendants to Respond. Signed by Judge Lucy H. Koh on 8/30/2011. (lhkcl2, COURT STAFF) (Filed on 8/30/2011) (Entered: 08/30/2011)
- 08/30/2011 192 \*\*\*FILED IN ERROR. PLEASE IGNORE.\*\*\* ORDER Setting Hearing. Signed by Judge Lucy H. Koh on 8/30/2011. (lhkcl2, COURT STAFF) (Filed on 8/30/2011) Modified on 8/30/2011 (lhkcl2, COURT STAFF). (Entered: 08/30/2011)
- 08/30/2011 193 Declaration of Cyndi Wheeler in Support of 169 Administrative Motion to File Under Seal filed by Apple Inc.. (Attachments: # 1 Proposed Order)(Related document(s) 169 ) (Bartlett, Jason) (Filed on 8/30/2011) (Entered: 08/30/2011)
- 08/30/2011 194 Declaration of Cyndi Wheeler in Support of 175 Administrative Motion to File Under Seal SAMSUNG'S OPPOSITION TO APPLE'S MOTION FOR PRELIMINARY INJUNCTION filed by Apple Inc.. (Attachments: # 1 Proposed Order)(Related document(s) 175 ) (Bartlett, Jason) (Filed on 8/30/2011) (Entered: 08/30/2011)
- 08/31/2011 195 Administrative Motion to File Under Seal Samsung's Motion to Compel filed by Samsung Electronics America, Inc., Samsung Electronics Co. Ltd., Samsung Telecommunications America, LLC. (Attachments: # 1 Jenkins Declaration, # 2 Proposed Order)(Maroulis, Victoria) (Filed on 8/31/2011) (Entered: 08/31/2011)
- 08/31/2011 196 Joint MOTION to Shorten Time Stipulated Motion to Expedite Briefing and Hearing on Samsung's Motion to Compel filed by Samsung Electronics America, Inc., Samsung Electronics Co. Ltd., Samsung Telecommunications America, LLC. (Attachments: # 1 Jenkins Declaration)(Maroulis, Victoria) (Filed on 8/31/2011) (Entered: 08/31/2011)
- 08/31/2011 197 CERTIFICATE OF SERVICE by Samsung Electronics America, Inc., Samsung Electronics Co. Ltd., Samsung Telecommunications America, LLC re 196 Joint MOTION to Shorten Time Stipulated Motion to Expedite Briefing and Hearing on Samsung's Motion to Compel , 195 Administrative Motion to File Under Seal Samsung's Motion to Compel and re: Samsung's Motion to Compel (Maroulis, Victoria) (Filed on 8/31/2011) (Entered: 08/31/2011)
- 08/31/2011 198 Letter Brief re 191 Order Responding to the Notice of Withdrawal of Bridges & Mavrakakis LLP filed by Samsung Electronics America, Inc., Samsung Electronics Co. Ltd., Samsung Telecommunications America, LLC. (Attachments: # 1 Exhibit A, # 2 Exhibit B, # 3 Proposed Order)(Related document(s) 191 ) (Maroulis, Victoria) (Filed on 8/31/2011) (Entered: 08/31/2011)
- 09/01/2011 199 STIPULATION AND ORDER GRANTING EXPEDITED BRIEFING AND HEARING ON SAMSUNG'S MOTION TO COMPEL re 196 Joint MOTION to Shorten Time Stipulated Motion to Expedite Briefing and Hearing on Samsung's Motion to Compel filed by Samsung Electronics Co. Ltd., Samsung Telecommunications America, LLC, Samsung Electronics America, Inc. Signed by Judge Paul S. Grewal on September 1, 2011. (psglc1, COURT STAFF) (Filed on 9/1/2011) (Entered: 09/01/2011)
- 09/01/2011 200 MODIFIED ORDER GRANTING SAMSUNG'S STIPULATED ADMINISTRATIVE MOTION TO FILE DOCUMENTS UNDER SEAL by Judge Paul S. Grewal granting 195 Administrative Motion to File Under Seal (psglc1, COURT STAFF) (Filed on 9/1/2011) (Entered: 09/01/2011)
- 09/01/2011 201 \*\*\* FILED IN ERROR. PLEASE SEE DOCKET # 203 . \*\*\* Letter from Stephen E. Taylor. (Taylor, Stephen) (Filed on 9/1/2011) Modified on 9/2/2011 (wv, COURT STAFF). (Entered: 09/01/2011)
- 09/01/2011 202 \*\*\* FILED IN ERROR. REFER TO DOCUMENT 204 . \*\*\* Proposed Order re 201 Letter filed by Apple Inc.. (Taylor, Stephen) (Filed on 9/1/2011) Modified on 9/6/2011 (feriab, COURT STAFF). (Entered: 09/01/2011)
- 09/01/2011 203 Letter from Stephen E. Taylor Corrected Version to Replace Docket No. 201 . (Taylor, Stephen) (Filed on 9/1/2011) (Entered: 09/01/2011)
- 09/01/2011 204 Proposed Order re 203 Letter from Stephen E. Taylor by Apple Inc.. (Taylor, Stephen) (Filed on 9/1/2011) (Entered: 09/01/2011)
- 09/01/2011 205 MOTION to Compel (Redacted) filed by Samsung Electronics America, Inc., Samsung Electronics Co. Ltd., Samsung Telecommunications America, LLC. Motion Hearing set for 9/13/2011 10:00 AM in Courtroom 5, 4th Floor, San Jose before Magistrate Judge Paul Singh Grewal. Responses due by 9/9/2011. Replies due by 9/12/2011. (Attachments: # 1 Jenkins Declaration, # 2 Exhibit A, # 3 Exhibit B, # 4 Exhibit C, # 5 Exhibit D, # 6

Exhibit E, # 7 Exhibit F, # 8 Exhibit G, # 9 Exhibit H, # 10 Exhibit I, # 11 Exhibit J, # 12 Exhibit K, # 13 Exhibit L, # 14 Exhibit M, # 15 Exhibit N, # 16 Exhibit O, # 17 Exhibit P, # 18 Exhibit Q, # 19 Proposed Order)(Maroulis, Victoria) (Filed on 9/1/2011) (Entered: 09/01/2011)

- 09/01/2011 206 DOCUMENT E-FILED UNDER SEAL re 200 Order on Administrative Motion to File Under Seal Motion to Compel by Samsung Electronics America, Inc., Samsung Electronics Co. Ltd., Samsung Telecommunications America, LLC. (Attachments: # 1 Jenkins Declaration, # 2 Exhibit D, # 3 Exhibit E, # 4 Exhibit F, # 5 Exhibit G, # 6 Exhibit H, # 7 Exhibit I, # 8 Exhibit J, # 9 Exhibit K, # 10 Exhibit L, # 11 Exhibit N, # 12 Exhibit O, # 13 Exhibit P)(Maroulis, Victoria) (Filed on 9/1/2011) (Entered: 09/01/2011)
- 09/01/2011 207 CERTIFICATE OF SERVICE by Samsung Electronics America, Inc., Samsung Electronics Co. Ltd., Samsung Telecommunications America, LLC re 206 Document E-Filed Under Seal,, (Maroulis, Victoria) (Filed on 9/1/2011) (Entered: 09/01/2011)
- 09/06/2011 208 STIPULATION and [Proposed] Order Extending Apple's Time to Respond to Samsung's Motion to Exclude Ordinary Observer Opinions of Apple Expert Cooper Woodring by Apple Inc.. (Attachments: # 1 Declaration)(Bartlett, Jason) (Filed on 9/6/2011) (Entered: 09/06/2011)
- 09/06/2011 209 REPLY (re 153 MOTION to Dismiss and MOTION to Strike Apple's Counterclaims ) filed by Samsung Electronics America, Inc., Samsung Electronics Co. Ltd., Samsung Telecommunications America, LLC. (Maroulis, Victoria) (Filed on 9/6/2011) (Entered: 09/06/2011)
- 09/07/2011 210 ORDER Extending Apple's Time to Respond to Samsung's Motion to Exclude Ordinary Observer Opinions of Apple Expert. Signed by Judge Lucy H. Koh on 9/6/2011. (lhkic2, COURT STAFF) (Filed on 9/7/2011) (Entered: 09/07/2011)
- 09/09/2011 211 Administrative Motion to File Under Seal filed by Apple Inc.. (Attachments: # 1 Declaration, # 2 Proposed Order)(Bartlett, Jason) (Filed on 9/9/2011) (Entered: 09/09/2011)
- 09/10/2011 212 CERTIFICATE OF SERVICE by Apple Inc. (Bartlett, Jason) (Filed on 9/10/2011) (Entered: 09/10/2011)
- 09/12/2011 213 Administrative Motion to File Under Seal Samsung's Reply in Support of its Motion to Compel filed by Samsung Electronics America, Inc., Samsung Electronics Co. Ltd., Samsung Telecommunications America, LLC. (Attachments: # 1 Arnold Declaration, # 2 Proposed Order)(Maroulis, Victoria) (Filed on 9/12/2011) (Entered: 09/12/2011)
- 09/12/2011 214 CERTIFICATE OF SERVICE re 224 Reply in Support of Motion to Compel, filed by Samsung Electronics America, Inc., Samsung Electronics Co. Ltd., Samsung Telecommunications America, LLC (Maroulis, Victoria) (Filed on 9/12/2011) Modified on 9/13/2011 linking entry to document #224 (dhm, COURT STAFF). (Entered: 09/12/2011)
- 09/12/2011 215 ORDER Granting Motion to File Under Seal AS MODIFIED BY THE COURT, ORDER re 211 Administrative Motion to File Under Seal filed by Apple Inc. Signed by Judge Paul S. Grewal on September 12, 2011. (psglc2S, COURT STAFF) (Filed on 9/12/2011) (Entered: 09/12/2011)
- 09/12/2011 216 ORDER re 213 Administrative Motion to File Under Seal Samsung's Reply in Support of its Motion to Compel filed by Samsung Electronics Co. Ltd., Samsung Telecommunications America, LLC, Samsung Electronics America, Inc., ORDER Granting Motion to File Under Seal. Signed by Judge Paul S. Grewal on September 12, 2011. (psglc2S, COURT STAFF) (Filed on 9/12/2011) (Entered: 09/12/2011)
- 09/12/2011 217 Letter from Richard Hung to Magistrate Judge Paul Singh Grewal . (Attachments: # 1 Exhibit A, # 2 Exhibit B, # 3 Exhibit C, # 4 Exhibit D, # 5 Exhibit E, # 6 Exhibit F, # 7 Exhibit G, # 8 Exhibit H)(Bartlett, Jason) (Filed on 9/12/2011) (Entered: 09/12/2011)
- 09/12/2011 218 DOCUMENT E-FILED UNDER SEAL re 215 Order Granting Motion to File Under Seal, Stipulation and Order Apple's Opposition to Samsung's Motion to Compel Regarding Request for Production No. 1 and Interrogatory Nos. 1, 3, and 6 by Apple Inc.. (Bartlett, Jason) (Filed on 9/12/2011) (Entered: 09/12/2011)
- 09/12/2011 219 DOCUMENT E-FILED UNDER SEAL re 215 Order Granting Motion to File Under Seal, Stipulation and Order Declaration of Jason R. Bartlett in Support of Apple's Opposition to Samsung's Motion to Compel Regarding Request for Production No. 1 and Interrogatory Nos. 1, 3, and 6 by Apple Inc.. (Attachments: # 1 Exhibit A, # 2 Exhibit B, # 3 Exhibit C, # 4 Exhibit D, # 5 Exhibit E, # 6 Exhibit F, # 7 Exhibit G, # 8 Exhibit H, # 9 Exhibit I, # 10 Exhibit J)(Bartlett, Jason) (Filed on 9/12/2011) (Entered: 09/12/2011)

- 09/12/2011 220 DOCUMENT E-FILED UNDER SEAL re 215 Order Granting Motion to File Under Seal, Stipulation and Order Declaration of Christopher J. Stringer in Support of Apple's Opposition to Samsung's Motion to Compel Regarding Request for Production No. 1 and Interrogatory Nos. 1, 3, and 6 by Apple Inc.. (Bartlett, Jason) (Filed on 9/12/2011) (Entered: 09/12/2011)
- 09/12/2011 221 DOCUMENT E-FILED UNDER SEAL re 215 Order Granting Motion to File Under Seal, Stipulation and Order Declaration of Patrick Zhang in Support of Apple's Opposition to Samsung's Motion to Compel Regarding Request for Production No. 1 and Interrogatory Nos. 1, 3, and 6 by Apple Inc.. (Bartlett, Jason) (Filed on 9/12/2011) (Entered: 09/12/2011)
- 09/12/2011 222 RESPONSE (re 205 MOTION to Compel (Redacted) MOTION to Compel (Redacted) ) Apple's Opposition to Samsung's Motion to Compel Regarding Request for Production No. 1 and Interrogatory Nos. 1, 3, and 6 (Public Redacted Version) filed by Apple Inc.. (Bartlett, Jason) (Filed on 9/12/2011) (Entered: 09/12/2011)
- 09/12/2011 223 DECLARATION of Jason R. Bartlett in Support of Opposition to 205 MOTION to Compel Request for Production No. 1 and Interrogatory Nos. 1, 3, and 6 (Public Redacted Version) filed by Apple Inc.. (Attachments: # 1 Exhibit A, # 2 Exhibit B, # 3 Exhibit C, # 4 Exhibit D, # 5 Exhibit E, # 6 Exhibit F, # 7 Exhibit G, # 8 Exhibit H, # 9 Exhibit I, # 10 Exhibit J)(Related document(s) 205 ) (Bartlett, Jason) (Filed on 9/12/2011) Modified text on 9/13/2011 (dhm, COURT STAFF). (Entered: 09/12/2011)
- 09/12/2011 224 REPLY (re 205 MOTION to Compel (Redacted) MOTION to Compel (Redacted) MOTION to Compel (Redacted) ) Redacted filed by Samsung Electronics America, Inc., Samsung Electronics Co. Ltd., Samsung Telecommunications America, LLC. (Maroulis, Victoria) (Filed on 9/12/2011) (Entered: 09/12/2011)
- 09/12/2011 225 DOCUMENT E-FILED UNDER SEAL re 216 Stipulation and Order,, Order Granting Motion to File Under Seal, Samsung's Reply in support of its Motion to Compel (Unredacted) by Samsung Electronics America, Inc., Samsung Electronics Co. Ltd., Samsung Telecommunications America, LLC. (Maroulis, Victoria) (Filed on 9/12/2011) (Entered: 09/12/2011)
- 09/12/2011 226 UNOPPOSED ADMINISTRATIVE MOTION Close the Courtroom re 205 MOTION to Compel, filed by Apple Inc.. Motion Hearing set for 9/13/2011 10:00 AM in Courtroom 5, 4th Floor, San Jose before Magistrate Judge Paul Singh Grewal. Responses due by 9/12/2011. Replies due by 9/12/2011. (Attachments: # 1 Proposed Order)(Bartlett, Jason) (Filed on 9/12/2011) Modified text on 9/13/2011 (dhm, COURT STAFF). (Entered: 09/12/2011)
- 09/12/2011 227 RESPONSE to re 217 Letter, to Magistrate Judge Paul Singh Grewal by Samsung Electronics America, Inc., Samsung Electronics Co. Ltd., Samsung Telecommunications America, LLC. (Maroulis, Victoria) (Filed on 9/12/2011) (Entered: 09/12/2011)
- 09/12/2011 228 ORDER by Judge Lucy H. Koh granting 132 Administrative Motion to File Under Seal (lhkic2, COURT STAFF) (Filed on 9/12/2011) (Entered: 09/12/2011)
- 09/12/2011 229 ORDER by Judge Lucy H. Koh granting 147 Administrative Motion to File Under Seal (lhkic2, COURT STAFF) (Filed on 9/12/2011) (Entered: 09/12/2011)
- 09/12/2011 230 ORDER by Judge Lucy H. Koh denying as moot 101 Motion to Disqualify Counsel. (lhkic2, COURT STAFF) (Filed on 9/12/2011) (Entered: 09/12/2011)
- 09/13/2011 231 Minute Entry: Motion Hearing held on 9/13/2011 before Magistrate Judge Paul S. Grewal (Date Filed: 9/13/2011) re 226 MOTION Close the Courtroom re 205 MOTION to Compel (Redacted) MOTION to Compel (Redacted) MOTION to Compel (Redacted) Apple's Unopposed Administrative Motion to Close the Courtroom MOTION Close the Courtroom re 205 MOTION to Compel (Redacted) MOTION to Compel (Redacted) MOTION to Compel (Redacted) Apple's Unopposed Administrative Motion to Close the Courtroom filed by Apple Inc., 205 MOTION to Compel (Redacted) MOTION to Compel (Redacted) MOTION to Compel (Redacted) filed by Samsung Electronics Co. Ltd., Samsung Telecommunications America, LLC, Samsung Electronics America, Inc. The Court orally grants Plaintiffs request to clear the courtroom; the courtroom is cleared. Parties present oral arguments. The Court takes matter under submission; written order after hearing to be issued. (Court Reporter Irene Toft.) (ofr, COURT STAFF) (Date Filed: 9/13/2011) (Entered: 09/13/2011)
- 09/13/2011 232 ORDER granting 226 Motion to Clear Courtroom entered by Magistrate Judge Paul Singh Grewal. (This is a text-only entry generated by the court. There is no document associated with this entry.) (Entered: 09/13/2011)

- 09/13/2011 233 ORDER by Judge Paul S. Grewal granting in part and denying in part 205 Motion to Compel (psglc2, COURT STAFF) (Filed on 9/13/2011) (Entered: 09/13/2011)
- 09/13/2011 234 Administrative Motion to File Under Seal Apple's Stipulated Administrative Motion to File Documents Under Seal filed by Apple Inc.. (Attachments: # 1 Declaration, # 2 Proposed Order)(Bartlett, Jason) (Filed on 9/13/2011) (Entered: 09/13/2011)
- 09/13/2011 235 DECLARATION of Cooper C. Woodring in Support of Apple's Opposition to Samsung's Motion to Exclude Ordinary Observer Opinions filed by Apple Inc.. (Bartlett, Jason) (Filed on 9/13/2011) Modified on 9/14/2011 cannot link entry-opposition not posted (dhm, COURT STAFF). (Entered: 09/13/2011)
- 09/13/2011 236 CERTIFICATE OF SERVICE by Apple Inc. re sealed and public documents lodged (Bartlett, Jason) (Filed on 9/13/2011) Modified text on 9/14/2011 (dhm, COURT STAFF). (Entered: 09/13/2011)
- 09/14/2011 237 REPLY in Support of 101 MOTION to Disqualify Counsel Bridges & Mavrakakis LLP, by Samsung Electronics America, Inc., Samsung Electronics Co. Ltd., Samsung Telecommunications America, LLC. (Attachments: # 1 Kim Declaration)(Maroulis, Victoria) (Filed on 9/14/2011) Modified on 9/15/2011 linking entry to document #101 (dhm, COURT STAFF). (Entered: 09/14/2011)
- 09/14/2011 238 REDACTED EXHIBIT F to 150 Declaration of Austin Tarango in Support of Reply in Support of 101 MOTION to Disqualify Bridges & Mavrakakis, LLP filed by Samsung Electronics America, Inc., Samsung Electronics Co. Ltd., Samsung Telecommunications America, LLC. (Related document(s) 150 ) (Maroulis, Victoria) (Filed on 9/14/2011) Modified on 9/15/2011 linking entry to document #101 (dhm, COURT STAFF). (Entered: 09/14/2011)
- 09/15/2011 239 DOCUMENT E-FILED UNDER SEAL re 229 Order on Administrative Motion to File Under Seal Reply in Support of Samsung's Motion to Disqualify Counsel Bridges & Mavrakakis LLP (Unredacted) by Samsung Electronics America, Inc., Samsung Electronics Co. Ltd., Samsung Telecommunications America, LLC. (Attachments: # 1 Unredacted Kim Declaration, # 2 Unredacted Exhibit F to Tarango Declaration (Dkt No. 150)) (Maroulis, Victoria) (Filed on 9/15/2011) (Entered: 09/15/2011)
- 09/19/2011 240 ORDER Granting 234 Administrative Motion to File Under Seal Apple's Stipulated Administrative Motion to File Documents Under Seal filed by Apple Inc. Signed by Judge Paul S. Grewal on 9/16/2011. (psglc2, COURT STAFF) (Filed on 9/19/2011) (Entered: 09/19/2011)
- 09/19/2011 241 DOCUMENT E-FILED UNDER SEAL re 240 Order Granting Motion to File Under Seal, by Apple Inc.. (Attachments: # 1 Declaration)(Bartlett, Jason) (Filed on 9/19/2011) (Entered: 09/19/2011)
- 09/19/2011 242 OPPOSITION to ( 176 MOTION SAMSUNG'S NOTICE OF MOTION AND MOTION TO EXCLUDE ORDINARY OBSERVER OPINIONS OF APPLE EXPERT COOPER WOODRING ); Declaration of Patrick Zhang in Support filed by Apple Inc.. (Attachments: # 1 Declaration)(Bartlett, Jason) (Filed on 9/19/2011) Modified text on 9/20/2011 (dhm, COURT STAFF). (Entered: 09/19/2011)
- 09/19/2011 243 UNOPPOSED MOTION to Move the Hearing Date for 153 Motion to Dismiss and Motion to Strike , filed by Samsung Electronics America, Inc., Samsung Electronics Co. Ltd., Samsung Telecommunications America, LLC. (Attachments: # 1 Arnold Declaration, # 2 Proposed Order)(Maroulis, Victoria) (Filed on 9/19/2011) Modified on 9/20/2011 linking entry to document #153 (dhm, COURT STAFF). (Entered: 09/19/2011)
- 09/20/2011 244 ORDER by Judge Lucy H. Koh granting 243 Motion to Continue (lhkic2, COURT STAFF) (Filed on 9/20/2011) (Entered: 09/20/2011)
- 09/20/2011 245 Administrative Motion to File Under Seal Samsung's Reply in Support of its Motion to Exclude Ordinary Observer Opinions of Apple Expert Cooper Woodring filed by Samsung Electronics America, Inc., Samsung Electronics Co. Ltd., Samsung Telecommunications America, LLC. (Attachments: # 1 Buchakjian Declaration, # 2 Proposed Order)(Maroulis, Victoria) (Filed on 9/20/2011) (Entered: 09/20/2011)
- 09/20/2011 246 CERTIFICATE OF SERVICE by Samsung Electronics America, Inc., Samsung Electronics Co. Ltd., Samsung Telecommunications America, LLC of sealed documents lodged,Reply in Support of Samsung's Motion to Exclude Ordinary Observer Opinions of Apple Expert Cooper Woodring. (Maroulis, Victoria) (Filed on 9/20/2011) Modified text on 9/21/2011 (dhm, COURT STAFF). (Entered: 09/20/2011)
- 09/20/2011 247 \*\*\* PURSUANT TO ORDER (DOC. #459) INCORRECTLY FILED DOCUMENT REMOVED \*\*\* MOTION to Compel Apple's Motion to Compel Samsung to Produce Documents and

Provide Responsive Answers to Propounded Discovery, filed by Apple Inc.. Motion Hearing set for 10/25/2011 10:00 AM in Courtroom 5, 4th Floor, San Jose before Magistrate Judge Paul Singh Grewal. Responses due by 10/4/2011. Replies due by 10/11/2011. (Attachments: # 1 Bartlett Declaration, # 2 Exhibit A, # 3 Exhibit B, # 4 Exhibit C, # 5 Exhibit D, # 6 Exhibit E, # 7 Exhibit F, # 8 Exhibit G, # 9 Exhibit H, # 10 Exhibit I, # 11 Exhibit J, # 12 Exhibit K, # 13 Exhibit L, # 14 Exhibit M, # 15 Chung Declaration, # 16 Proposed Order)(Bartlett, Jason) (Filed on 9/20/2011) Modified on 9/21/2011 (ewn, COURT STAFF). (Additional attachment(s) added on 12/8/2011: # 17 Document Removed Notice) (dhm, COURT STAFF). Modified on 12/8/2011 (dhm, COURT STAFF). (Entered: 09/20/2011)

- 09/21/2011 248 MOTION to Remove Incorrectly Filed Document Docket No. 247 filed by Apple Inc.. (Attachments: # 1 Proposed Order)(Bartlett, Jason) (Filed on 9/21/2011) (Entered: 09/21/2011)
- 09/21/2011 249 Administrative Motion to File Under Seal filed by Apple Inc.. (Bartlett, Jason) (Filed on 9/21/2011) (Entered: 09/21/2011)
- 09/21/2011 250 CERTIFICATE OF SERVICE by Apple Inc. (Bartlett, Jason) (Filed on 9/21/2011) (Entered: 09/21/2011)
- 09/21/2011 251 STIPULATION and Proposed Order Extending Deadline for Apple's Discovery of Samsung by Apple Inc.. (Attachments: # 1 Declaration)(Bartlett, Jason) (Filed on 9/21/2011) (Entered: 09/21/2011)
- 09/22/2011 252 ORDER re 248 MOTION to Remove Incorrectly Filed Document Docket No. 247 filed by Apple Inc. Signed by Judge Paul S. Grewal on 9/22/2011. (psglc2, COURT STAFF) (Filed on 9/22/2011) (Entered: 09/22/2011)
- 09/23/2011 253 MOTION to Expedite Briefing and Hearing on Apple's Motion to Compel filed by Apple Inc.. (Attachments: # 1 Declaration, # 2 Proposed Order)(Bartlett, Jason) (Filed on 9/23/2011) (Entered: 09/23/2011)
- 09/23/2011 254 ORDER Regarding Stipulation to Extend Discovery. Signed by Judge Lucy H. Koh on 9/23/2011. (lhkic2, COURT STAFF) (Filed on 9/23/2011) (Entered: 09/23/2011)
- 09/23/2011 255 ORDER by Judge Paul S. Grewal granting 253 Motion to Expedite (psglc2, COURT STAFF) (Filed on 9/23/2011) (Entered: 09/23/2011)
- 09/23/2011 256 MOTION for Leave to File Amicus Curiae Brief filed by Cellco Partnership dba Verizon Wireless. (Attachments: # 1 Proposed Order)(Morton, Melinda) (Filed on 9/23/2011) (Entered: 09/23/2011)
- 09/23/2011 257 Brief Amicus Curiae Brief filed by Cellco Partnership dba Verizon Wireless. (Morton, Melinda) (Filed on 9/23/2011) (Entered: 09/23/2011)
- 09/23/2011 -- \*\*\*Deadlines terminated. 255 Order on Motion to Expedite. 10/25/2011 Motion to Compel rescheduled to 9/28/11 before Judge Paul S. Grewal. (ofr, COURT STAFF) (Filed on 9/23/2011) (Entered: 09/28/2011)
- 09/26/2011 258 OPPOSITION to ( 247 MOTION to Compel Samsung to Produce Documents and Provide Responsive Answers to Propounded Discovery ) filed by Samsung Electronics America, Inc., Samsung Electronics Co. Ltd., Samsung Telecommunications America, LLC. (Attachments: # 1 Proposed Order)(Maroulis, Victoria) (Filed on 9/26/2011) Modified text on 9/27/2011 (dhm, COURT STAFF). (Entered: 09/26/2011)
- 09/26/2011 259 Administrative Motion to File Under Seal Documents in Support of Samsung's Opposition to Apple's Motion to Compel (Dkt No. 258) filed by Samsung Electronics America, Inc., Samsung Electronics Co. Ltd., Samsung Telecommunications America, LLC. (Attachments: # 1 Arnold Declaration, # 2 Proposed Order)(Maroulis, Victoria) (Filed on 9/26/2011) (Entered: 09/26/2011)
- 09/27/2011 260 CERTIFICATE OF SERVICE by Samsung Electronics America, Inc., Samsung Electronics Co. Ltd., Samsung Telecommunications America, LLC re 258 Opposition/Response to Motion, Documents in Support of Samsung's Opposition to Apple's Motion to Compel (Maroulis, Victoria) (Filed on 9/27/2011) (Entered: 09/27/2011)
- 09/27/2011 261 Declaration of Hankil Daniel Kang in Support of 249 Administrative Motion to File Under Seal filed by Samsung Electronics America, Inc., Samsung Electronics Co. Ltd., Samsung Telecommunications America, LLC. (Attachments: # 1 Proposed Order)(Related document(s) 249 ) (Maroulis, Victoria) (Filed on 9/27/2011) (Entered: 09/27/2011)
- 09/27/2011 262 OPPOSITION (re 256 MOTION for Leave to File Amicus Curiae Brief Regarding Regarding Apple's Motion for a Preliminary Injunction filed by Apple Inc.. (Bartlett, Jason) (Filed on 9/27/2011) Modified text on 9/28/2011 (dhm, COURT STAFF). (Entered: 09/27/2011)

- 09/28/2011 263 MOTION for Leave to File Brief of Amicus Curiae T-Mobile re Apple Inc's Motion for a Preliminary Injunction and for Leave to Appear at Preliminary Injunction Hearing filed by T-Mobile USA, Inc.. (Attachments: # 1 Proposed Order)(Bettinger, Michael) (Filed on 9/28/2011) Modified on 9/29/2011 counsel failed to select multiple motion event types (dhm, COURT STAFF). (Entered: 09/28/2011)
- 09/28/2011 264 Brief re 263 MOTION for Leave to File Brief of Amicus Curiae T-Mobile re Apple Inc's Motion for a Preliminary Injunction Amicus Curiae T-Mobile re Apple Inc.'s Motion for a Preliminary Injunction filed by T-Mobile USA, Inc.. (Related document(s) 263 ) (Bettinger, Michael) (Filed on 9/28/2011) (Entered: 09/28/2011)
- 09/28/2011 265 MOTION to Shorten Time ON 263 MOTION FOR LEAVE TO FILE BRIEF OF AMICUS CURIAE T-MOBILE REGARDING APPLE INC.S MOTION FOR A PRELIMINARY INJUNCTION filed by T-Mobile USA, Inc.. (Attachments: # 1 Declaration Yang ISO Motion to Shorten Time, # 2 Exhibit Exhibit A, # 3 Proposed Order)(Bettinger, Michael) (Filed on 9/28/2011) Modified on 9/29/2011 linking entry to document #263 (dhm, COURT STAFF). (Entered: 09/28/2011)
- 09/28/2011 266 Minute Entry: Motion Hearing held on 9/28/2011 before Magistrate Judge Paul S. Grewal (Date Filed: 9/28/2011) re 247 MOTION to Compel Apple's Motion to Compel Samsung to Produce Documents and Provide Responsive Answers to Propounded Discovery filed by Apple Inc. The Court takes matter under submission; written order after hearing to be issued. (Court Reporter: Summer Fisher.) (ofr, COURT STAFF) (Date Filed: 9/28/2011) (Entered: 09/28/2011)
- 09/28/2011 267 ORDER by Judge Paul S. Grewal granting in part and denying in part 247 Motion to Compel (psglc2, COURT STAFF) (Filed on 9/28/2011) (Entered: 09/28/2011)
- 09/28/2011 268 ORDER Granting Motion to File Under Seal re 249 Administrative Motion to File Under Seal filed by Apple Inc. Signed by Judge Paul S. Grewal on 9/28/2011. (psglc2, COURT STAFF) (Filed on 9/28/2011) (Entered: 09/28/2011)
- 09/28/2011 269 ORDER re 259 Administrative Motion to File Under Seal Documents in Support of Samsung's Opposition to Apple's Motion to Compel (Dkt No. 258) . Signed by Judge Paul S. Grewal on 9/28/2011. (psglc2, COURT STAFF) (Filed on 9/28/2011) (Entered: 09/28/2011)
- 09/29/2011 270 REPLY in support of ( 256 MOTION for Leave to File Amicus Curiae Brief ) filed by Cellco Partnership dba Verizon Wireless. (Morton, Melinda) (Filed on 9/29/2011) Modified text on 9/30/2011 (dhm, COURT STAFF). (Entered: 09/29/2011)
- 09/29/2011 271 OPPOSITION to ( 263 MOTION for Leave to File Brief of Amicus Curiae T-Mobile re Apple Inc's Motion for a Preliminary Injunction and for Leave to Appear at Preliminary Injunction Hearing ) filed by Apple Inc.. (Bartlett, Jason) (Filed on 9/29/2011) Modified text on 9/30/2011 (dhm, COURT STAFF). (Entered: 09/29/2011)
- 09/29/2011 272 MOTION for Leave to File Excess Pages Motion for Administrative Relief to Exceed Page Limit filed by Apple Inc.. (Attachments: # 1 Declaration, # 2 Exhibit A, # 3 Exhibit B, # 4 Exhibit C, # 5 Exhibit D, # 6 Exhibit E, # 7 Exhibit F, # 8 Exhibit G, # 9 Proposed Order) (Bartlett, Jason) (Filed on 9/29/2011) (Entered: 09/29/2011)
- 09/30/2011 273 RESPONSE (re 272 MOTION for Leave to File Excess Pages Motion for Administrative Relief to Exceed Page Limit ) Samsung's Opposition to Apple's Motion to Exceed Page Limit filed by Samsung Electronics America, Inc., Samsung Electronics Co. Ltd., Samsung Telecommunications America, LLC. (Attachments: # 1 Proposed Order)(Maroulis, Victoria) (Filed on 9/30/2011) (Entered: 09/30/2011)
- 09/30/2011 274 NOTICE of Appearance by Richard S.J. Hung (Hung, Richard) (Filed on 9/30/2011) (Entered: 09/30/2011)
- 09/30/2011 275 REPLY (re 272 MOTION for Leave to File Excess Pages Motion for Administrative Relief to Exceed Page Limit ) filed by Apple Inc.. (Attachments: # 1 Declaration, # 2 Exhibit A) (Hung, Richard) (Filed on 9/30/2011) (Entered: 09/30/2011)
- 09/30/2011 276 ORDER REGARDING VARIOUS ADMINISTRATIVE MOTIONS by Judge Lucy H. Koh granting 163 Motion for Leave to File Excess Pages; granting 256 Motion for Leave to File; granting in part and denying in part 263 Motion for Leave to File; finding as moot 265 Motion to Shorten Time; granting 272 Motion for Leave to File Excess Pages(Ihkic2, COURT STAFF) (Filed on 9/30/2011) Modified text on 10/3/2011 (dhm, COURT STAFF). (Entered: 09/30/2011)
- 09/30/2011 277 Transcript of Proceedings held on 09/28/2011, before Judge Lucy H. Koh. Court Reporter/Transcriber Summer Fisher, Telephone number 408-288-6150. Per General Order No. 59 and Judicial Conference policy, this transcript may be viewed only at the

Clerks Office public terminal or may be purchased through the Court Reporter/Transcriber until the deadline for the Release of Transcript Restriction. After that date it may be obtained through PACER. Any Notice of Intent to Request Redaction, if required, is due no later than 5 business days from date of this filing. Release of Transcript Restriction set for 12/29/2011. (Fisher, Summer) (Filed on 9/30/2011) (Entered: 09/30/2011)

- 09/30/2011 278 Reply Declaration of Ravin Balakrishnan, Ph.D. in Support of 86 Apple's Motion for Preliminary Injunction filed by Apple Inc.. (Attachments: # 1 Exhibit A - Manual Filing Notification, # 2 Exhibit B - Manual Filing Notification, # 3 Exhibit C - Manual Filing Notification, # 4 Exhibit D, # 5 Exhibit E, # 6 Exhibit F, # 7 Exhibit G, # 8 Exhibit H, # 9 Exhibit I, # 10 Exhibit J, # 11 Exhibit K, # 12 Exhibit L, # 13 Exhibit M, # 14 Exhibit N, # 15 Exhibit O)(Jacobs, Michael) (Filed on 9/30/2011) Modified on 10/3/2011 linking entry to document #86 (dhm, COURT STAFF). (Entered: 09/30/2011)
- 09/30/2011 279 Reply Declaration of Peter W. Bressler in Support of 86 Apple's Motion for Preliminary Injunction filed by Apple Inc.. (Attachments: # 1 Exhibit 1, # 2 Exhibit 2, # 3 Exhibit 3, # 4 Exhibit 4, # 5 Exhibit 5, # 6 Exhibit 6, # 7 Exhibit 7, # 8 Exhibit 8, # 9 Exhibit 9, # 10 Exhibit 10, # 11 Exhibit 11, # 12 Exhibit 12, # 13 Exhibit 13, # 14 Exhibit 14, # 15 Exhibit 15, # 16 Exhibit 16, # 17 Exhibit 17, # 18 Exhibit 18, # 19 Exhibit 19, # 20 Exhibit 20, # 21 Exhibit 21, # 22 Exhibit 22, # 23 Exhibit 23, # 24 Exhibit 24, # 25 Exhibit 25, # 26 Exhibit 26, # 27 Exhibit 27, # 28 Exhibit 28, # 29 Exhibit 29, # 30 Exhibit 30, # 31 Exhibit 31)(Jacobs, Michael) (Filed on 9/30/2011) Modified on 10/3/2011 linkine entry to document #86 (dhm, COURT STAFF). (Entered: 09/30/2011)
- 09/30/2011 280 EXHIBITS in Support of {279} Declaration of Peter W. Bressler Exhibit 32 filed by Apple Inc.. (Attachments: # 1 Exhibit 33, # 2 Exhibit 34, # 3 Exhibit 35, # 4 Exhibit 36, # 5 Exhibit 37, # 6 Exhibit 38, # 7 Exhibit 39, # 8 Exhibit 40, # 9 Exhibit 41, # 10 Exhibit 42, # 11 Exhibit 43, # 12 Exhibit 44, # 13 Exhibit 45)(Related document(s) 279 ) (Jacobs, Michael) (Filed on 9/30/2011) Modified text on 10/3/2011 (dhm, COURT STAFF). (Entered: 09/30/2011)
- 09/30/2011 281 EXHIBITS in Support of 279 Declaration of Peter W. Bressler Exhibit 46 filed by Apple Inc.. (Attachments: # 1 Exhibit 47, # 2 Exhibit 48, # 3 Exhibit 49, # 4 Exhibit 50, # 5 Exhibit 51, # 6 Exhibit 52, # 7 Exhibit 53, # 8 Exhibit 54, # 9 Exhibit 55, # 10 Exhibit 56, # 11 Exhibit 57, # 12 Exhibit 58, # 13 Exhibit 59, # 14 Exhibit 60, # 15 Exhibit 61, # 16 Exhibit 62, # 17 Exhibit 63, # 18 Exhibit 64, # 19 Exhibit 65, # 20 Exhibit 66, # 21 Exhibit 67, # 22 Exhibit 68)(Related document(s) 279 ) (Jacobs, Michael) (Filed on 9/30/2011) Modified text on 10/3/2011 (dhm, COURT STAFF). (Entered: 09/30/2011)
- 09/30/2011 282 STIPULATED ADMINISTRATIVE MOTION to File Under Seal Apple's Reply in Support of Its Motion for Preliminary Injunction and Related Documents filed by Apple Inc.. (Attachments: # 1 Declaration, # 2 Proposed Order)(Jacobs, Michael) (Filed on 9/30/2011) Modified text on 10/4/2011 (dhm, COURT STAFF). (Entered: 09/30/2011)
- 10/01/2011 283 MOTION to Compel Apple to Schedule Inventor Depositions filed by Samsung Electronics America, Inc., Samsung Electronics Co. Ltd., Samsung Telecommunications America, LLC. Motion Hearing set for 11/8/2011 10:00 AM in Courtroom 5, 4th Floor, San Jose before Magistrate Judge Paul Singh Grewal. Responses due by 10/17/2011. Replies due by 10/24/2011. (Attachments: # 1 Kassabian Declaration, # 2 Proposed Order)(Maroulis, Victoria) (Filed on 10/1/2011) (Entered: 10/01/2011)
- 10/01/2011 284 EXHIBITS re 283 MOTION to Compel Apple to Schedule Inventor Depositions -- Exhibits 1 and 2 to the Kassabian Declaration in support of Samsung's Motion to Compel (Dkt No. 283-1) filed by Samsung Electronics America, Inc., Samsung Electronics Co. Ltd., Samsung Telecommunications America, LLC. (Attachments: # 1 Exhibit)(Related document(s) 283 ) (Maroulis, Victoria) (Filed on 10/1/2011) (Entered: 10/01/2011)
- 10/01/2011 285 MOTION to Shorten Time for Briefing and Hearing on 283 Samsung's Motion to Compel, filed by Samsung Electronics America, Inc., Samsung Electronics Co. Ltd., Samsung Telecommunications America, LLC. (Attachments: # 1 Kassabian Declaration, # 2 Proposed Order)(Maroulis, Victoria) (Filed on 10/1/2011) Modified on 10/3/2011 linking entry to document #283 (dhm, COURT STAFF). (Entered: 10/01/2011)
- 10/03/2011 286 CERTIFICATE OF SERVICE re sealed documents and redacted documents submitted by Apple Inc on 10/3/2011. (Bartlett, Jason) (Filed on 10/3/2011) Modified text on 10/4/2011 (dhm, COURT STAFF). (Entered: 10/03/2011)
- 10/03/2011 287 ORDER by Judge Paul S. Grewal granting-in-part 285 Motion to Shorten Time (psglc2, COURT STAFF) (Filed on 10/3/2011) (Entered: 10/03/2011)
- 10/04/2011 288 OPPOSITION to ( 283 MOTION to Compel Apple to Schedule Inventor Depositions ) filed by Apple Inc.. (Jacobs, Michael) (Filed on 10/4/2011) Modified text on 10/5/2011 (dhm,

- COURT STAFF). (Entered: 10/04/2011)
- 10/04/2011 289 DECLARATION of Jason R. Bartlett in Opposition to 283 MOTION to Compel Apple to Schedule Inventor Depositions and Prosecuting Attorney Depositions, filed by Apple Inc.. (Attachments: # 1 Exhibit A, # 2 Exhibit B, # 3 Exhibit C, # 4 Exhibit D)(Related document(s) 283 ) (Jacobs, Michael) (Filed on 10/4/2011) Modified text on 10/5/2011 (dhm, COURT STAFF). (Entered: 10/04/2011)
- 10/04/2011 290 AMENDED DECLARATION of Jason R. Bartlett in Support of Opposition to 283 MOTION to Compel Apple to Schedule Inventor Depositions and Prosecuting Attorney Depositions, filed by Apple Inc.. (Attachments: # 1 Exhibit A, # 2 Exhibit B, # 3 Exhibit C, # 4 Exhibit D)(Related document(s) 283 ) (Jacobs, Michael) (Filed on 10/4/2011) Modified text on 10/5/2011 (dhm, COURT STAFF). (Entered: 10/04/2011)
- 10/04/2011 291 Statement of Recent Decision (L.R. 7-3(d)) by Apple Inc.. (Attachments: # 1 Attachment)(Jacobs, Michael) (Filed on 10/4/2011) (Entered: 10/04/2011)
- 10/04/2011 292 ORDER by Judge Paul S. Grewal granting-in-part 283 Motion to Compel (psglc2, COURT STAFF) (Filed on 10/4/2011) (Entered: 10/04/2011)
- 10/04/2011 293 Minute Entry: Motion Hearing held on 10/4/2011 before Magistrate Judge Paul S. Grewal (Date Filed: 10/4/2011) re 283 MOTION to Compel Apple to Schedule Inventor Depositions filed by Samsung Electronics Co. Ltd., Samsung Telecommunications America, LLC, Samsung Electronics America, Inc. Parties present oral arguments. The Court to issue order after hearing. (Court Reporter FTR: (5:02 to 5:29.) (ofr, COURT STAFF) (Date Filed: 10/4/2011) (Entered: 10/04/2011)
- 10/04/2011 294 OBJECTIONS to Apple's Use of Non-Rebuttal Evidence in Apple's Preliminary Injunction Reply Brief by Samsung Electronics America, Inc., Samsung Electronics Co. Ltd., Samsung Telecommunications America, LLC. (Attachments: # 1 Supporting Declaration of Alex Binder and Exhibit A to the Binder Declaration, # 2 Proposed Order)(Maroulis, Victoria) (Filed on 10/4/2011) (Entered: 10/04/2011)
- 10/07/2011 295 Proposed Order Permitting Use of Equipment in the Courtroom by Samsung Electronics America, Inc.. (Maroulis, Victoria) (Filed on 10/7/2011) (Entered: 10/07/2011)
- 10/11/2011 296 ORDER PERMITTING USE OF EQUIPMENT IN THE COURTROOM. Signed by Judge Lucy H. Koh on 10/11/11. (mpb, COURT STAFF) (Filed on 10/11/2011) (Entered: 10/11/2011)
- 10/11/2011 297 NOTICE of Appearance by Andrew Ellis Monach (Monach, Andrew) (Filed on 10/11/2011) (Entered: 10/11/2011)
- 10/11/2011 298 Administrative Motion to File Under Seal Unopposed Administrative Motion to File Apple's Motion to Augment Record and Supporting Documents Under Seal filed by Apple Inc.. (Jacobs, Michael) (Filed on 10/11/2011) (Entered: 10/11/2011)
- 10/11/2011 299 Declaration of Michael A. Jacobs in Support of Apple's Administrative Motion to Augment Record filed by Apple Inc.. (Attachments: # 1 Proposed Order)(Jacobs, Michael) (Filed on 10/11/2011) (Entered: 10/11/2011)
- 10/11/2011 302 APPLICATION of Peter J. Kolovos for Admission Pro Hac Vice ( Filing fee \$ 275, receipt number 54611010539) filed by Apple Inc.. (dhm, COURT STAFF) (Filed on 10/11/2011) (Entered: 10/12/2011)
- 10/11/2011 303 Proposed Order re 302 APPLICATION of Peter J. Kolovos for Admission Pro Hac Vice ( Filing fee \$ 275, receipt number 54611010539) by Apple Inc.. (dhm, COURT STAFF) (Filed on 10/11/2011) (Entered: 10/12/2011)
- 10/12/2011 300 CERTIFICATE OF SERVICE by Apple Inc. (Jacobs, Michael) (Filed on 10/12/2011) (Entered: 10/12/2011)
- 10/12/2011 301 OPPOSITION to Apple's Motion to Augment the Record (submitted under seal), filed by Samsung Electronics America, Inc., Samsung Electronics Co. Ltd., Samsung Telecommunications America, LLC. (Maroulis, Victoria) (Filed on 10/12/2011) Modified on 10/13/2011 entry cannot be linked. Motion to Augment the Record not efiled (dhm, COURT STAFF). (Entered: 10/12/2011)
- 10/12/2011 304 Statement of Recent Decision (L.R. 7-3(d)) by Apple Inc.. (Jacobs, Michael) (Filed on 10/12/2011) (Entered: 10/12/2011)
- 10/13/2011 305 Minute Entry: Motion Hearing held on 10/13/2011 before Judge Lucy H. Koh (Date Filed: 10/13/2011) re 176 MOTION SAMSUNG'S NOTICE OF MOTION AND MOTION TO EXCLUDE ORDINARY OBSERVER OPINIONS OF APPLE EXPERT COOPER WOODRING; AND MEMORANDUM OF POINTS AND AUTHORITIES IN SUPPORT FILED UNDER SEAL filed by Samsung Electronics Co. Ltd., Samsung Telecommunications America, LLC, Samsung Electronics America, Inc., 86 MOTION for Preliminary Injunction filed by Apple Inc..



- (Court Reporter Lee-Anne Shortridge.) (mpb, COURT STAFF) (Date Filed: 10/13/2011) (Entered: 10/13/2011)
- 10/17/2011 306 \*\*\* FILED IN ERROR. REFER TO DOCUMENT 313 . \*\*\* Brief Memorandum in Support of Samsung's Notice of Lodging of Materials filed by Samsung Electronics America, Inc., Samsung Electronics Co. Ltd., Samsung Telecommunications America, LLC. (Maroulis, Victoria) (Filed on 10/17/2011) Modified on 10/18/2011 (feriab, COURT STAFF). (Entered: 10/17/2011)
- 10/17/2011 307 NOTICE by Samsung Electronics America, Inc., Samsung Electronics Co. Ltd., Samsung Telecommunications America, LLC of Lodging of Materials in Opposition to Apple's Motion for Preliminary Injunction (Maroulis, Victoria) (Filed on 10/17/2011) (Entered: 10/17/2011)
- 10/17/2011 308 Administrative Motion to File Under Seal filed by Apple Inc.. (Attachments: # 1 Declaration, # 2 Proposed Order)(Jacobs, Michael) (Filed on 10/17/2011) (Entered: 10/17/2011)
- 10/17/2011 309 Declaration of Jennifer Lee Taylor n Support of Apple's Objections to Samsung's Untimely Evidence, filed by Apple Inc.. (Attachments: # 1 Exhibit 1, # 2 Exhibit 2, # 3 Exhibit 3, # 4 Exhibit 4, # 5 Exhibit 5, # 6 Exhibit 6, # 7 Exhibit 7, # 8 Exhibit 8)(Jacobs, Michael) (Filed on 10/17/2011) Modified on 10/18/2011. Cannot link entry. Objections have not been efiled (dhm, COURT STAFF). (Entered: 10/17/2011)
- 10/17/2011 310 Declaration of Grant L. Kim in Support of Apple's Objections to Samsung's Untimely New Evidence, filed by Apple Inc.. (Attachments: # 1 Exhibit A, # 2 Notice of Manual Filing Exhibit B, # 3 Exhibit C, # 4 Exhibit D, # 5 Notice of Manual Filing Exhibit E, # 6 Exhibit F, # 7 Notice of Manual Filing Exhibit G, # 8 Exhibit H, # 9 Exhibit I, # 10 Exhibit J) (Jacobs, Michael) (Filed on 10/17/2011) Modified on 10/18/2011. Cannot link entry. Ojections have not been efiled. NOTICES OF MANUAL FILING ARE NOT IN COMPLIANCE WITH GENERAL ORDER NO. 62 (dhm, COURT STAFF). (Entered: 10/17/2011)
- 10/17/2011 311 Manual Filing Notification by Apple Inc. re: Apple's Objections to Samsung's Untimely New Evidence Regarding Preliminary Injunction Motion, (Jacobs, Michael) (Filed on 10/17/2011) Modified on 10/18/2011 \*\*\*DOCUMENT POSTED IS NOT IN COMPLIANCE WITH GENERAL ORDER NO. 62 \*\*\* (dhm, COURT STAFF). (Entered: 10/17/2011)
- 10/18/2011 312 CERTIFICATE OF SERVICE by Apple Inc. (Jacobs, Michael) (Filed on 10/18/2011) (Entered: 10/18/2011)
- 10/18/2011 313 Memorandum in Support of 306 Samsung's Notice of Lodging of Materials CORRECTION OF DOCKET # 306 , filed by Samsung Electronics America, Inc., Samsung Electronics Co. Ltd., Samsung Telecommunications America, LLC. (Related document(s) 306 ) (Maroulis, Victoria) (Filed on 10/18/2011) Modified text on 10/19/2011 (dhm, COURT STAFF). (Entered: 10/18/2011)
- 10/18/2011 314 Letter from William F. Lee Request to Postpone Scheduled October 20 Hearing . (Selwyn, Mark) (Filed on 10/18/2011) (Entered: 10/18/2011)
- 10/18/2011 315 ORDER by Judge Lucy H. Koh granting in part and denying in part 153 Motion to Dismiss (lhkic2, COURT STAFF) (Filed on 10/18/2011) (Entered: 10/18/2011)
- 10/18/2011 316 DOCUMENT E-FILED UNDER SEAL re 268 Order Granting Motion to File Under Seal, Apple's Motion to Compel Samsung to Produce Documents and Provide Responsive Answers to Propounded Discovery by Apple Inc.. (Bartlett, Jason) (Filed on 10/18/2011) (Entered: 10/18/2011)
- 10/18/2011 317 DOCUMENT E-FILED UNDER SEAL re 268 Order Granting Motion to File Under Seal, Declaration of Minn Chung in Support of Apple's Motion to Compel Samsung to Produce Documents and Provide Responsive Answers to Propounded Discovery by Apple Inc.. (Bartlett, Jason) (Filed on 10/18/2011) (Entered: 10/18/2011)
- 10/18/2011 318 DOCUMENT E-FILED UNDER SEAL re 268 Order Granting Motion to File Under Seal, Declaration of Jason R. Bartlett in Support of Apple's Motion to Compel Samsung to Produce Documents and Provide Responsive Answers to Propounded Discovery by Apple Inc.. (Attachments: # 1 Exhibit J)(Bartlett, Jason) (Filed on 10/18/2011) (Entered: 10/18/2011)
- 10/18/2011 319 MOTION to Compel Apple's Motion to Compel SamSung to Produce Documents and Provide Responsive Answers to Propounded Discovery filed by Apple Inc.. Motion Hearing set for 10/25/2011 10:00 AM in Courtroom 5, 4th Floor, San Jose before Magistrate Judge Paul Singh Grewal. Responses due by 10/4/2011. Replies due by 10/11/2011. (Attachments: # 1 Proposed Order)(Bartlett, Jason) (Filed on 10/18/2011) (Entered: 10/18/2011)

- 10/18/2011 320 Declaration of Minn Chung in Support of 319 Apple's Motion to Compel Samsung to Produce Documents and Provide Responsive Answers to Propounded Discovery, filed by Apple Inc. (Bartlett, Jason) (Filed on 10/18/2011) Modified on 10/19/2011 linking entry to document #319 (dhm, COURT STAFF). (Entered: 10/18/2011)
- 10/18/2011 321 Declaration of Jason R. Bartlett in Support of 319 Apple's Motion to Compel Samsung to Produce Documents and Provide Responsive Answers to Propounded Discovery filed by Apple Inc.. (Attachments: # 1 Exhibit A, # 2 Exhibit B, # 3 Exhibit C, # 4 Exhibit D, # 5 Exhibit E, # 6 Exhibit F, # 7 Exhibit G, # 8 Exhibit H, # 9 Exhibit I, # 10 Exhibit J, # 11 Exhibit K, # 12 Exhibit L, # 13 Exhibit M)(Bartlett, Jason) (Filed on 10/18/2011) Modified on 10/19/2011 linking entry to document #319 (dhm, COURT STAFF). (Entered: 10/18/2011)
- 10/18/2011 322 STIPULATION AND [PROPOSED] ORDER EXTENDING DEADLINE FOR DEPOSITIONS OF INVENTORS OF APPLE'S PATENTS by Apple Inc., Samsung Electronics America, Inc., Samsung Electronics Co. Ltd., Samsung Telecommunications America, LLC. (Attachments: # 1 Declaration Melissa N. Chan In Support Of, # 2 Declaration Teresa N. Burlison In Support Of)(Maroulis, Victoria) (Filed on 10/18/2011) (Entered: 10/18/2011)
- 10/20/2011 323 NOTICE of Appearance by Erik J. Olson (Olson, Erik) (Filed on 10/20/2011) (Entered: 10/20/2011)
- 10/21/2011 324 APPLICATION of James C. Burling for Admission Pro Hac Vice ( Filing fee \$ 275, receipt number 54611010600) filed by Apple Inc.. (dhm, COURT STAFF) (Filed on 10/21/2011) (Entered: 10/24/2011)
- 10/21/2011 325 Proposed Order re 324 APPLICATION of James C. Burling for Admission Pro Hac Vice ( Filing fee \$ 275, receipt number 54611010600) by Apple Inc.. (dhm, COURT STAFF) (Filed on 10/21/2011) (Entered: 10/24/2011)
- 10/26/2011 326 ORDER Extending Deadline For Depositions of Inventors of Apple's Patents. Signed by Judge Lucy H. Koh on 10/26/2011. (lhklc2, COURT STAFF) (Filed on 10/26/2011) (Entered: 10/26/2011)
- 10/27/2011 327 Administrative Motion to File Under Seal APPLES UNOPPOSED ADMINISTRATIVE MOTION TO FILE DOCUMENTS UNDER SEAL filed by Apple Inc.. (Attachments: # 1 Declaration, # 2 Proposed Order)(Jacobs, Michael) (Filed on 10/27/2011) (Entered: 10/27/2011)
- 10/27/2011 328 CERTIFICATE OF SERVICE by Apple Inc. BY ELECTRONIC SERVICE re documents submitted under seal (Jacobs, Michael) (Filed on 10/27/2011) Modified text on 10/28/2011 (dhm, COURT STAFF). (Entered: 10/27/2011)
- 10/27/2011 329 NOTICE by Apple Inc. APPLE'S NOTICE OF LODGMET OF EXHIBIT G TO THE DECLARATION OF MICHAEL A. JACOBS IN SUPPORT OF APPLE'S MOTION FOR A PROTECTIVE ORDER AND MOTION TO SHORTEN TIME (Jacobs, Michael) (Filed on 10/27/2011) (Entered: 10/27/2011)
- 10/27/2011 330 CERTIFICATE OF SERVICE by Apple Inc. CERTIFICATE OF PERSONAL DELIVERY (VERHOEVEN) re documents submitted under seal (Jacobs, Michael) (Filed on 10/27/2011) Modified text on 10/28/2011 (dhm, COURT STAFF). (Entered: 10/27/2011)
- 10/27/2011 331 CERTIFICATE OF SERVICE by Apple Inc. CERTIFICATE OF PERSONAL DELIVERY (JOHNSON) re documents submitted under seal (Jacobs, Michael) (Filed on 10/27/2011) Modified text on 10/28/2011 (dhm, COURT STAFF). (Entered: 10/27/2011)
- 10/27/2011 332 ORDER re motion for shortened time re 327 . Signed by Judge Paul S. Grewal on 10/27/2011. (psglc2, COURT STAFF) (Filed on 10/27/2011) (Entered: 10/27/2011)
- 10/28/2011 333 NOTICE of Appearance by Victor F. Souto (Souto, Victor) (Filed on 10/28/2011) (Entered: 10/28/2011)
- 10/28/2011 334 NOTICE by Apple Inc. Apple's Notice of Lodgment of Corrected Exhibit G to the Declaration of Michael A. Jacobs in Support of Apple's Motion for a Protective Order and Motion to Shorten Time (Attachments: # 1 Certificate/Proof of Service)(Jacobs, Michael) (Filed on 10/28/2011) (Entered: 10/28/2011)
- 10/28/2011 335 APPLICATION of David B. Bassett for Admission Pro Hac Vice ( Filing fee \$ 275, receipt number 54611010642.) filed by Apple Inc.. (dhm, COURT STAFF) (Filed on 10/28/2011) (Entered: 10/28/2011)
- 10/28/2011 336 Proposed Order re 335 APPLICATION of David B. Bassett for Admission Pro Hac Vice ( Filing fee \$ 275, receipt number 54611010642.) by Apple Inc. (dhm, COURT STAFF) (Filed on 10/28/2011) (Entered: 10/28/2011)
- 10/28/2011 337 APPLICATION of Emily R. Whelan for Admission Pro Hac Vice ( Filing fee \$ 275, receipt number 54611010642) filed by Apple Inc. (dhm, COURT STAFF) (Filed on 10/28/2011)

- (Entered: 10/28/2011)
- 10/28/2011 338 Proposed Order re 337 APPLICATION of Emily R. Whelan for Admission Pro Hac Vice ( Filing fee \$ 275, receipt number 54611010642.) by Apple Inc.. (dhm, COURT STAFF) (Filed on 10/28/2011) (Entered: 10/28/2011)
- 10/28/2011 339 APPLICATION of Brian Larivee for Admission Pro Hac Vice ( Filing fee \$ 275, receipt number 54611010642) filed by Apple Inc. (dhm, COURT STAFF) (Filed on 10/28/2011) (Entered: 10/28/2011)
- 10/28/2011 340 Administrative Motion to File Under Seal Samsung's Opposition to Apple's Motion for a Protective Order filed by Samsung Electronics America, Inc., Samsung Electronics Co. Ltd., Samsung Telecommunications America, LLC. (Attachments: # 1 Arnold Declaration, # 2 Proposed Order)(Maroulis, Victoria) (Filed on 10/28/2011) (Entered: 10/28/2011)
- 10/28/2011 341 Proposed Order re 339 APPLICATION of Brian Larivee for Admission Pro Hac Vice ( Filing fee \$ 275, receipt number 54611010642.) by Apple Inc.. (dhm, COURT STAFF) (Filed on 10/28/2011) (Entered: 10/28/2011)
- 10/28/2011 342 APPLICATION of Robert D. Cultice for Admission Pro Hac Vice ( Filing fee \$ 275, receipt number 54611010642.) filed by Apple Inc. (dhm, COURT STAFF) (Filed on 10/28/2011) (Entered: 10/28/2011)
- 10/28/2011 343 Proposed Order re 342 APPLICATION of Robert D. Cultice for Admission Pro Hac Vice ( Filing fee \$ 275, receipt number 54611010642.) by Apple Inc. (dhm, COURT STAFF) (Filed on 10/28/2011) (Entered: 10/28/2011)
- 10/28/2011 344 CERTIFICATE OF SERVICE by Samsung Electronics America, Inc., Samsung Electronics Co. Ltd., Samsung Telecommunications America, LLC (Maroulis, Victoria) (Filed on 10/28/2011) (Entered: 10/28/2011)
- 10/28/2011 345 MOTION to Amend/Correct 124 Answer to to CounterClaim,, Counterclaim, Apple's Unopposed Motion for Leave to Amend its Answer, Defenses, and Counterclaims in Reply to Samsung's Counterclaims filed by Apple Inc.. Responses due by 11/14/2011. Replies due by 11/21/2011. (Attachments: # 1 Exhibit 1, # 2 Proposed Order)(Selwyn, Mark) (Filed on 10/28/2011) (Entered: 10/28/2011)
- 10/28/2011 346 Administrative Motion to File Under Seal Samsung's Motion to Compel Apple to Produce Documents and Things filed by Samsung Electronics America, Inc., Samsung Electronics Co. Ltd., Samsung Telecommunications America, LLC. (Attachments: # 1 Declaration, # 2 Proposed Order)(Maroulis, Victoria) (Filed on 10/28/2011) (Entered: 10/28/2011)
- 10/28/2011 347 CERTIFICATE OF SERVICE by Samsung Electronics America, Inc., Samsung Electronics Co. Ltd., Samsung Telecommunications America, LLC re: Samsung's Motion to Compel Apple to Produce Documents and Things (Maroulis, Victoria) (Filed on 10/28/2011) (Entered: 10/28/2011)
- 10/28/2011 367 APPLICATION of Ali Shah for Admission Pro Hac Vice ( Filing fee \$ 275.00, receipt number 54611010658) filed by Apple Inc. (dhm, COURT STAFF) (Filed on 10/28/2011) (Entered: 11/03/2011)
- 10/28/2011 368 Proposed Order re 367 APPLICATION of Ali H. Shah for Admission Pro Hac Vice ( Filing fee \$ 275.00, receipt number 54611010658) by Apple Inc. (dhm, COURT STAFF) (Filed on 10/28/2011) (Entered: 11/03/2011)
- 10/31/2011 348 OPPOSITION (re 346 Administrative Motion to File Under Seal Samsung's Motion to Compel Apple to Produce Documents and Things ) Apple's Opposition to Samsung's Motion to Shorten Time on Motion to Compel Apple to Produce Documents and Things filed by Apple Inc.. (Jacobs, Michael) (Filed on 10/31/2011) Modified text on 11/1/2011 (dhm, COURT STAFF). (Entered: 10/31/2011)
- 10/31/2011 349 ORDER re 346 Administrative Motion to File Under Seal Samsung's Motion to Compel Apple to Produce Documents and Things filed by Samsung Electronics Co. Ltd., Samsung Telecommunications America, LLC, Samsung Electronics America, Inc. Signed by Judge Paul S. Grewal on 10/31/2011. (psglc2, COURT STAFF) (Filed on 10/31/2011) (Entered: 10/31/2011)
- 10/31/2011 350 ORDER re [346-1] Administrative Motion to File Under Seal Samsung's Motion to Compel Apple to Produce Documents and Things filed by Samsung Electronics Co. Ltd., Samsung Telecommunications America, LLC, Samsung Electronics America, Inc. Signed by Judge Paul S. Grewal on 10/31/2011. (psglc2, COURT STAFF) (Filed on 10/31/2011) (Entered: 10/31/2011)
- 10/31/2011 351 Unopposed Administrative Motion to File Under Seal filed by Apple Inc.. (Attachments: # 1 Declaration, # 2 Proposed Order)(Jacobs, Michael) (Filed on 10/31/2011) Modified text

- on 11/1/2011 (dhm, COURT STAFF). (Entered: 10/31/2011)
- 10/31/2011 354 APPLICATION of Jeremy Winer for Admission Pro Hac Vice ( Filing fee \$ 275, receipt number 54611010659) filed by Apple Inc. (dhm, COURT STAFF) (Filed on 10/31/2011) (Entered: 11/01/2011)
- 10/31/2011 355 Proposed Order re 354 APPLICATION of Jeremy Winer for Admission Pro Hac Vice ( Filing fee \$ 275, receipt number 54611010659) by Apple Inc. (dhm, COURT STAFF) (Filed on 10/31/2011) (Entered: 11/01/2011)
- 10/31/2011 356 APPLICATION of Robert J. Gunther, Jr. for Admission Pro Hac Vice ( Filing fee \$ 275, receipt number 54611010659) filed by Apple Inc. (dhm, COURT STAFF) (Filed on 10/31/2011) (Entered: 11/01/2011)
- 10/31/2011 357 Proposed Order re 356 APPLICATION of Robert J. Gunther, Jr. for Admission Pro Hac Vice ( Filing fee \$ 275, receipt number 54611010659) by Apple Inc. (dhm, COURT STAFF) (Filed on 10/31/2011) (Entered: 11/01/2011)
- 11/01/2011 352 CERTIFICATE OF SERVICE by Apple Inc. re 351 Administrative Motion to File Under Seal Apple's Unopposed Administration Motion to File Documents Under Seal CERTIFICATE OF SERVICE BY ELECTRONIC MAIL (Jacobs, Michael) (Filed on 11/1/2011) (Entered: 11/01/2011)
- 11/01/2011 353 CERTIFICATE OF SERVICE by Apple Inc. re 351 Administrative Motion to File Under Seal Apple's Unopposed Administration Motion to File Documents Under Seal CERTIFICATE OF SERVICE BY ELECTRONIC SERVICE OF THE CORRECTED DECLARATION OF MICHAEL A. JACOBS IN OPPOSITION TO SAMSUNG'S MOTION TO COMPEL (Jacobs, Michael) (Filed on 11/1/2011) (Entered: 11/01/2011)
- 11/01/2011 358 Minute Entry: Motion Hearing held on 11/1/2011 before Magistrate Judge Paul S. Grewal (Date Filed: 11/1/2011) re 346 Administrative Motion to File Under Seal Samsung's Motion to Compel Apple to Produce Documents and Things filed by Samsung Electronics Co. Ltd., Samsung Telecommunications America, LLC, Samsung Electronics America, Inc., 327 Administrative Motion to File Under Seal APPLES UNOPPOSED ADMINISTRATIVE MOTION TO FILE DOCUMENTS UNDER SEAL filed by Apple Inc. The Court takes matters under submission; written order after hearing to be issued. (Court Reporter: Gina Galvan Colin.) (ofr, COURT STAFF) (Date Filed: 11/1/2011) (Entered: 11/01/2011)
- 11/03/2011 359 ORDER by Judge Lucy H. Koh granting 354 Motion for Pro Hac Vice (lhkic2, COURT STAFF) (Filed on 11/3/2011) (Entered: 11/03/2011)
- 11/03/2011 360 ORDER by Judge Lucy H. Koh granting 356 Motion for Pro Hac Vice (lhkic2, COURT STAFF) (Filed on 11/3/2011) (Entered: 11/03/2011)
- 11/03/2011 361 ORDER by Judge Lucy H. Koh granting 337 Motion for Pro Hac Vice (lhkic2, COURT STAFF) (Filed on 11/3/2011) (Entered: 11/03/2011)
- 11/03/2011 362 ORDER by Judge Lucy H. Koh granting 335 Motion for Pro Hac Vice (lhkic2, COURT STAFF) (Filed on 11/3/2011) (Entered: 11/03/2011)
- 11/03/2011 363 ORDER by Judge Lucy H. Koh granting 339 Motion for Pro Hac Vice (lhkic2, COURT STAFF) (Filed on 11/3/2011) (Entered: 11/03/2011)
- 11/03/2011 364 ORDER by Judge Lucy H. Koh granting 342 Motion for Pro Hac Vice (lhkic2, COURT STAFF) (Filed on 11/3/2011) (Entered: 11/03/2011)
- 11/03/2011 365 ORDER by Judge Lucy H. Koh granting 324 Motion for Pro Hac Vice (lhkic2, COURT STAFF) (Filed on 11/3/2011) (Entered: 11/03/2011)
- 11/03/2011 366 ORDER by Judge Lucy H. Koh granting 302 Motion for Pro Hac Vice (lhkic2, COURT STAFF) (Filed on 11/3/2011) (Entered: 11/03/2011)
- 11/03/2011 369 NOTICE of Appearance by Mark D. Flanagan (Flanagan, Mark) (Filed on 11/3/2011) (Entered: 11/03/2011)
- 11/04/2011 370 STIPULATION AND [PROPOSED] ORDER SEALING NOVEMBER 1, 2011 HEARING TRANSCRIPT by Apple Inc.. (Hung, Richard) (Filed on 11/4/2011) (Entered: 11/04/2011)
- 11/04/2011 371 Minute Entry: Hearing as to Mid-Deposition Dispute held on 11/4/2011 before Magistrate Judge Paul S. Grewal. Phone conference held. Dispute resolved. (Date Filed: 11/4/2011). (Court Reporter FTR: (12:02 to 12:16.) (ofr, COURT STAFF) (Date Filed: 11/4/2011) (Entered: 11/04/2011)
- 11/04/2011 373 APPLICATION of Michael A. Diener for Admission Pro Hac Vice ( Filing fee \$ 305, receipt number 54611010701) filed by Apple Inc. (dhm, COURT STAFF) (Filed on 11/4/2011) (Entered: 11/07/2011)

- 11/04/2011 374 Proposed Order re 373 APPLICATION of Michael A. Diener for Admission Pro Hac Vice ( Filing fee \$ 305, receipt number 54611010701) by Apple Inc.. (dhm, COURT STAFF) (Filed on 11/4/2011) (Entered: 11/07/2011)
- 11/07/2011 372 Supplemental Statement Concerning Samsung's Motion to Compel re 346 Administrative Motion to File Under Seal by Apple Inc.. (Jacobs, Michael) (Filed on 11/7/2011) Modified text on 11/8/2011 (dhm, COURT STAFF). (Entered: 11/07/2011)
- 11/07/2011 375 STIPULATION AND ORDER re 370 Stipulation filed by Apple Inc. Signed by Judge Paul S. Grewal on 11/7/2011. (psglc2, COURT STAFF) (Filed on 11/7/2011) (Entered: 11/07/2011)
- 11/07/2011 376 NOTICE of Lodging of Corrected Exhibit C to the Declaration of Francis Ho in Support of Apple's Reply in support of its Motion for a preliminary Injunction ( re 282 STIPULATED ADMINISTRATIVE MOTION to File Under Seal Apple's Reply in Support of Its Motion for Preliminary Injunction and Related Documents ) (Jacobs, Michael) by Apple (Filed on 11/7/2011) Modified text on 11/8/2011 (dhm, COURT STAFF). (Entered: 11/07/2011)
- 11/07/2011 377 CERTIFICATE OF SERVICE by Apple Inc. CERTIFICATE OF SERVICE BY ELECTRONIC SERVICE OF THE DECLARATION OF FRANCIS HO (Jacobs, Michael) (Filed on 11/7/2011) (Entered: 11/07/2011)
- 11/07/2011 378 Administrative Motion to File Under Seal Samsung's Response to Apple's Supplemental Statement (Dkt No. 372) filed by Samsung Electronics America, Inc., Samsung Electronics Co. Ltd., Samsung Telecommunications America, LLC. (Attachments: # 1 Declaration, # 2 Proposed Order)(Johnson, Kevin) (Filed on 11/7/2011) (Entered: 11/07/2011)
- 11/08/2011 379 CERTIFICATE OF SERVICE by Samsung Electronics America, Inc., Samsung Electronics Co. Ltd., Samsung Telecommunications America, LLC Samsung's Response to Apple's Supplemental Statement (Maroulis, Victoria) (Filed on 11/8/2011) (Entered: 11/08/2011)
- 11/08/2011 380 NOTICE of filing of Apple's Amended Counterclaims in Reply by Apple Inc. re 315 Order on Motion to Dismiss, 345 MOTION to Amend/Correct 124 Answer to to CounterClaim,, Counterclaim, Apple's Unopposed Motion for Leave to Amend its Answer, Defenses, and Counterclaims in Reply to Samsung's Counterclaims MOTION to Amend/Correct 124 Answer to to CounterClaim,, Counterclaim, Apple's Unopposed Motion for Leave to Amend its Answer, Defenses, and Counterclaims in Reply to Samsung's Counterclaims (Selwyn, Mark) (Filed on 11/8/2011) Modified text on 11/9/2011 (dhm, COURT STAFF). (Entered: 11/08/2011)
- 11/08/2011 381 ANSWER TO COUNTERCLAIM 80 Answer to Amended Complaint,,, Counterclaim,, Amended Answer, Defenses, and , COUNTERCLAIM In Reply to Samsung's Counterclaims against Samsung Electronics America, Inc., Samsung Electronics Co. Ltd., Samsung Telecommunications America, LLC by Apple Inc.. (Selwyn, Mark) (Filed on 11/8/2011) (Entered: 11/08/2011)
- 11/09/2011 382 ORDER by Judge Lucy H. Koh granting 373 Motion for Pro Hac Vice (lhkic2, COURT STAFF) (Filed on 11/9/2011) (Entered: 11/09/2011)
- 11/09/2011 383 ORDER by Judge Lucy H. Koh granting 367 Motion for Pro Hac Vice (lhkic2, COURT STAFF) (Filed on 11/9/2011) (Entered: 11/09/2011)
- 11/09/2011 384 DOCUMENT E-FILED UNDER SEAL re 269 Order, Order Granting Motion to File Under Seal Declaration of Melissa Chan in Support of Samsung's Opposition to Apple's Motion to Compel (Dkt No. 258) by Samsung Electronics America, Inc., Samsung Electronics Co. Ltd., Samsung Telecommunications America, LLC. (Attachments: # 1 Exhibit 10, # 2 Exhibit 15, # 3 Exhibit 16, # 4 Exhibit 17)(Maroulis, Victoria) (Filed on 11/9/2011) (Entered: 11/09/2011)
- 11/09/2011 385 DOCUMENT E-FILED UNDER SEAL re 269 Order, Order Granting Motion to File Under Seal Declaration of Sara Jenkins in Support of Samsung's Opposition to Apple's Motion to Compel (Dkt No. 258) by Samsung Electronics America, Inc., Samsung Electronics Co. Ltd., Samsung Telecommunications America, LLC. (Maroulis, Victoria) (Filed on 11/9/2011) (Entered: 11/09/2011)
- 11/09/2011 386 DOCUMENT E-FILED UNDER SEAL re 269 Order, Order Granting Motion to File Under Seal Declaration of Russell Wilkins in Support of Samsung's Opposition to Apple's Motion to Compel (Dkt No. 258) by Samsung Electronics America, Inc., Samsung Electronics Co. Ltd., Samsung Telecommunications America, LLC. (Maroulis, Victoria) (Filed on 11/9/2011) (Entered: 11/09/2011)
- 11/09/2011 387 Declaration of Melissa Chan in Support of 258 Opposition/Response to Motion, filed

- by Samsung Electronics America, Inc., Samsung Electronics Co. Ltd., Samsung Telecommunications America, LLC. (Attachments: # 1 Exhibit 1, # 2 Exhibit 2, # 3 Exhibit 3, # 4 Exhibit 4, # 5 Exhibit 5, # 6 Exhibit 6, # 7 Exhibit 7, # 8 Exhibit 8, # 9 Exhibit 10, # 10 Exhibit 11, # 11 Exhibit 12, # 12 Exhibit 13, # 13 Exhibit 14, # 14 Exhibit 15, # 15 Exhibit 16, # 16 Exhibit 17, # 17 Exhibit 18, # 18 Exhibit 19, # 19 Exhibit 20, # 20 Exhibit 21, # 21 Exhibit 22)(Related document(s) 258 ) (Maroulis, Victoria) (Filed on 11/9/2011) (Entered: 11/09/2011)
- 11/09/2011 388 Declaration of Sara Jenkins in Support of 258 Opposition/Response to Motion, filed by Samsung Electronics America, Inc., Samsung Electronics Co. Ltd., Samsung Telecommunications America, LLC. (Related document(s) 258 ) (Maroulis, Victoria) (Filed on 11/9/2011) (Entered: 11/09/2011)
- 11/09/2011 389 Declaration of Russell Wilkins in Support of 258 Opposition/Response to Motion, filed by Samsung Electronics America, Inc., Samsung Electronics Co. Ltd., Samsung Telecommunications America, LLC. (Related document(s) 258 ) (Maroulis, Victoria) (Filed on 11/9/2011) (Entered: 11/09/2011)
- 11/09/2011 390 Administrative Motion to File Under Seal filed by Apple Inc.. (Attachments: # 1 Declaration, # 2 Proposed Order)(Olson, Erik) (Filed on 11/9/2011) (Entered: 11/09/2011)
- 11/09/2011 391 CERTIFICATE OF SERVICE by Apple Inc. (Olson, Erik) (Filed on 11/9/2011) (Entered: 11/09/2011)
- 11/09/2011 392 CERTIFICATE OF SERVICE by Samsung Electronics America, Inc., Samsung Electronics Co. Ltd., Samsung Telecommunications America, LLC re 378 Administrative Motion to File Under Seal Samsung's Response to Apple's Supplemental Statement (Dkt No. 372) Administrative Motion to File Under Seal Samsung's Response to Apple's Supplemental Statement (Dkt No. 372) Proof of Service of the Supporting Declaration Filed Under Seal at Dkt No. 378-1 (Maroulis, Victoria) (Filed on 11/9/2011) (Entered: 11/09/2011)
- 11/10/2011 393 NOTICE of Appearance by Liv Leila Herriot (Herriot, Liv) (Filed on 11/10/2011) (Entered: 11/10/2011)
- 11/14/2011 394 CLAIM CONSTRUCTION STATEMENT JOINT CLAIM CONSTRUCTION AND PREHEARING STATEMENT PURSUANT TO PATENT L.R. 4-3 filed by Apple Inc.(a California corporation). (Jacobs, Michael) (Filed on 11/14/2011) (Entered: 11/14/2011)
- 11/15/2011 395 NOTICE of Appearance by Andrew L Liao (Liao, Andrew) (Filed on 11/15/2011) (Entered: 11/15/2011)
- 11/15/2011 396 APPLICATION of Richard Goldenberg for Admission Pro Hac Vice ( Filing fee \$ 305, receipt number 54611010762) filed by Apple Inc. (Attachments: # 1 Receipt)(dhm, COURT STAFF) (Filed on 11/15/2011) (Entered: 11/16/2011)
- 11/15/2011 397 Proposed Order re 396 APPLICATION of Richard Goldenberg for Admission Pro Hac Vice ( Filing fee \$ 305, receipt number 54611010762) by Apple Inc. (dhm, COURT STAFF) (Filed on 11/15/2011) (Entered: 11/16/2011)
- 11/15/2011 400 APPLICATION of Michael Saji for Admission Pro Hac Vice ( Filing fee \$ 305, receipt number 54611010762) filed by Apple Inc. (Attachments: # 1 Receipt)(dhm, COURT STAFF) (Filed on 11/15/2011) (Entered: 11/16/2011)
- 11/15/2011 401 Proposed Order re 400 APPLICATION of Michael Saji for Admission Pro Hac Vice ( Filing fee \$ 305, receipt number 54611010762) by Apple Inc. (dhm, COURT STAFF) (Filed on 11/15/2011) (Entered: 11/16/2011)
- 11/15/2011 402 APPLICATION of Brian Seeve for Admission Pro Hac Vice ( Filing fee \$ 305, receipt number 54611010762) filed by Apple Inc. (Attachments: # 1 Receipt)(dhm, COURT STAFF) (Filed on 11/15/2011) (Entered: 11/16/2011)
- 11/15/2011 403 Proposed Order re 402 APPLICATION of Brian Seeve for Admission Pro Hac Vice ( Filing fee \$ 305, receipt number 54611010762) by Apple Inc. (dhm, COURT STAFF) (Filed on 11/15/2011) (Entered: 11/16/2011)
- 11/16/2011 398 ORDER Granting-in-Part 346 Samsung's Motion to Compel Apple to Produce Documents and Things filed by Samsung Electronics Co. Ltd., Samsung Telecommunications America, LLC, Samsung Electronics America, Inc. Signed by Judge Paul S. Grewal on 11/16/2011. (psglc2, COURT STAFF) (Filed on 11/16/2011) (Entered: 11/16/2011)
- 11/16/2011 399 ORDER re 327 APPLES UNOPPOSED ADMINISTRATIVE MOTION TO FILE DOCUMENTS UNDER SEAL filed by Apple Inc. Order DENYING Apple's Motion for Protective Order. Signed by Judge Paul S. Grewal on 11/16/2011. (psglc2, COURT STAFF) (Filed on 11/16/2011) (Entered: 11/16/2011)

- 11/21/2011 404 Sealed Transcript of Proceedings held on 11/1/2011, before Judge Paul S. Grewal. Court Reporter/Transcriber Gina Galvan Colin, Telephone number (408) 888-6697. Per General Order No. 59 and Judicial Conference policy, any Notice of Intent to Request Redaction, if required, is due no later than 5 business days from date of this filing. Redaction Request due 12/9/2011. Redacted Transcript Deadline set for 12/19/2011. (mz, COURT STAFF) (Filed on 11/21/2011) (Entered: 11/21/2011)
- 11/22/2011 405 MOTION to Dismiss Apple's Amended Counterclaims filed by Samsung Electronics America, Inc.(a New York corporation), Samsung Electronics Co. Ltd.(a Korean corporation), Samsung Telecommunications America, LLC(a Delaware limited liability company). Motion Hearing set for 4/5/2012 01:30 PM in Courtroom 8, 4th Floor, San Jose before Hon. Lucy H. Koh. Responses due by 12/6/2011. Replies due by 12/13/2011. (Attachments: # 1 Proposed Order, # 2 Declaration of Eric Wall, # 3 Exhibit 1 to Wall Declaration, # 4 Declaration of Remy Libchaber)(Maroulis, Victoria) (Filed on 11/22/2011) (Entered: 11/22/2011)
- 11/28/2011 406 ORDER by Judge Lucy H. Koh granting 169 Administrative Motion to File Under Seal (lhkic2, COURT STAFF) (Filed on 11/28/2011) (Entered: 11/28/2011)
- 11/28/2011 407 ORDER by Judge Lucy H. Koh granting 175 Administrative Motion to File Under Seal (lhkic2, COURT STAFF) (Filed on 11/28/2011) (Entered: 11/28/2011)
- 11/28/2011 408 ORDER by Judge Lucy H. Koh granting 234 Administrative Motion to File Under Seal (lhkic2, COURT STAFF) (Filed on 11/28/2011) (Entered: 11/28/2011)
- 11/28/2011 409 ORDER by Judge Lucy H. Koh granting 245 Administrative Motion to File Under Seal (lhkic2, COURT STAFF) (Filed on 11/28/2011) (Entered: 11/28/2011)
- 11/28/2011 410 ORDER by Judge Lucy H. Koh granting 282 Administrative Motion to File Under Seal (lhkic2, COURT STAFF) (Filed on 11/28/2011) (Entered: 11/28/2011)
- 11/28/2011 411 ORDER by Judge Lucy H. Koh granting 308 Administrative Motion to File Under Seal (lhkic2, COURT STAFF) (Filed on 11/28/2011) (Entered: 11/28/2011)
- 11/28/2011 412 ORDER by Judge Lucy H. Koh granting 396 Motion for Pro Hac Vice (lhkic2, COURT STAFF) (Filed on 11/28/2011) (Entered: 11/28/2011)
- 11/28/2011 413 ORDER by Judge 11/28/2011 granting 400 Motion for Pro Hac Vice (lhkic2, COURT STAFF) (Filed on 11/28/2011) (Entered: 11/28/2011)
- 11/28/2011 414 ORDER by Judge Lucy H. Koh granting 402 Motion for Pro Hac Vice (lhkic2, COURT STAFF) (Filed on 11/28/2011) (Entered: 11/28/2011)
- 11/28/2011 415 DOCUMENT E-FILED UNDER SEAL re 410 Order on Administrative Motion to File Under Seal Apple's Reply in Support of Its Motion for a Preliminary Injunction by Apple Inc.. (Bartlett, Jason) (Filed on 11/28/2011) (Entered: 11/28/2011)
- 11/28/2011 416 DOCUMENT E-FILED UNDER SEAL re 410 Order on Administrative Motion to File Under Seal Declaration of Tony Blevins in Support of Apple's Motion for a Preliminary Injunction by Apple Inc.. (Attachments: # 1 Exhibit A, # 2 Exhibit B)(Bartlett, Jason) (Filed on 11/28/2011) (Entered: 11/28/2011)
- 11/28/2011 417 DOCUMENT E-FILED UNDER SEAL re 410 Order on Administrative Motion to File Under Seal Declaration of Francis Ho in Support of Apple's Reply in Support of Its Motion for a Preliminary Injunction by Apple Inc.. (Attachments: # 1 Exhibit A, # 2 Exhibit B, # 3 Exhibit C-1, # 4 Exhibit C-2, # 5 Exhibit C-3, # 6 Exhibit C-4, # 7 Exhibit C-5, # 8 Exhibit C-6, # 9 Exhibit D, # 10 Exhibit E, # 11 Exhibit F-1, # 12 Exhibit F-2, # 13 Exhibit G, # 14 Exhibit H, # 15 Exhibit I, # 16 Exhibit J-1, # 17 Exhibit J-2, # 18 Exhibit K, # 19 Exhibit L-1, # 20 Exhibit L-2, # 21 Exhibit M, # 22 Exhibit N, # 23 Exhibit O, # 24 Exhibit P, # 25 Exhibit Q, # 26 Exhibit R, # 27 Exhibit S, # 28 Exhibit T, # 29 Exhibit U, # 30 Exhibit V, # 31 Exhibit W, # 32 Exhibit X, # 33 Exhibit Y, # 34 Exhibit Z, # 35 Exhibit AA, # 36 Exhibit BB, # 37 Exhibit CC, # 38 Exhibit DD, # 39 Exhibit EE, # 40 Exhibit FF, # 41 Exhibit GG, # 42 Exhibit HH, # 43 Exhibit II, # 44 Exhibit JJ, # 45 Exhibit KK, # 46 Exhibit LL)(Bartlett, Jason) (Filed on 11/28/2011) (Entered: 11/28/2011)
- 11/28/2011 418 DOCUMENT E-FILED UNDER SEAL re 410 Order on Administrative Motion to File Under Seal Reply Declaration of Richard J. Lutton, Jr. in Support of Apple's Motion for Preliminary Injunction by Apple Inc.. (Attachments: # 1 Exhibit A, # 2 Exhibit B-1, # 3 Exhibit B-2, # 4 Exhibit B-3, # 5 Exhibit B-4, # 6 Exhibit C)(Bartlett, Jason) (Filed on 11/28/2011) (Entered: 11/28/2011)
- 11/28/2011 419 DOCUMENT E-FILED UNDER SEAL re 410 Order on Administrative Motion to File Under Seal Reply Declaration of Terry L. Musika, CPA in Support of Apple's Motion for Preliminary Injunction by Apple Inc.. (Attachments: # 1 Exhibit 1, # 2 Exhibit 2, # 3

- Exhibit 3, # 4 Exhibit 4)(Bartlett, Jason) (Filed on 11/28/2011) (Entered: 11/28/2011)
- 11/28/2011 420 DOCUMENT E-FILED UNDER SEAL re 410 Order on Administrative Motion to File Under Seal Reply Declaration of Arthur Rangel in Support of Apple's Motion for a Preliminary Injunction by Apple Inc.. (Attachments: # 1 Exhibit A-1, # 2 Exhibit A-2, # 3 Exhibit B-1, # 4 Exhibit B-2, # 5 Exhibit C)(Bartlett, Jason) (Filed on 11/28/2011) (Entered: 11/28/2011)
- 11/28/2011 421 DOCUMENT E-FILED UNDER SEAL re 410 Order on Administrative Motion to File Under Seal Reply Declaration of Sanjay Sood in Support of Apple's Motion for a Preliminary Injunction by Apple Inc.. (Attachments: # 1 Exhibit A, # 2 Exhibit B, # 3 Exhibit C, # 4 Exhibit D-1, # 5 Exhibit D-2, # 6 Exhibit E, # 7 Exhibit F, # 8 Exhibit G, # 9 Exhibit H, # 10 Exhibit I)(Bartlett, Jason) (Filed on 11/28/2011) (Entered: 11/28/2011)
- 11/28/2011 422 DOCUMENT E-FILED UNDER SEAL re 410 Order on Administrative Motion to File Under Seal Reply Declaration of Christopher Stringer in Support of Apple's Motion for a Preliminary Injunction by Apple Inc.. (Attachments: # 1 Exhibit 1, # 2 Exhibit 2, # 3 Exhibit 3, # 4 Exhibit 4, # 5 Exhibit 5, # 6 Exhibit 6, # 7 Exhibit 7, # 8 Exhibit 8, # 9 Exhibit 9)(Bartlett, Jason) (Filed on 11/28/2011) (Entered: 11/28/2011)
- 11/28/2011 423 DOCUMENT E-FILED UNDER SEAL re 410 Order on Administrative Motion to File Under Seal Reply Declaration of Cooper C. Woodring in Support of Apple's Motion for a Preliminary Injunction by Apple Inc.. (Attachments: # 1 Exhibit 1, # 2 Exhibit 2, # 3 Exhibit 3, # 4 Exhibit 4, # 5 Exhibit 5, # 6 Exhibit 6, # 7 Exhibit 7, # 8 Exhibit 8, # 9 Exhibit 9, # 10 Exhibit 10, # 11 Exhibit 11, # 12 Exhibit 12, # 13 Exhibit 13, # 14 Exhibit 14, # 15 Exhibit 15, # 16 Exhibit 16, # 17 Exhibit 17, # 18 Exhibit 18, # 19 Exhibit 19, # 20 Exhibit 20, # 21 Exhibit 21, # 22 Exhibit 22, # 23 Exhibit 23, # 24 Exhibit 24, # 25 Exhibit 25, # 26 Exhibit 26, # 27 Exhibit 27, # 28 Exhibit 28, # 29 Exhibit 29, # 30 Exhibit 30, # 31 Exhibit 31, # 32 Exhibit 32, # 33 Exhibit 33, # 34 Exhibit 34, # 35 Exhibit 35, # 36 Exhibit 36, # 37 Exhibit 37, # 38 Exhibit 38, # 39 Exhibit 39, # 40 Exhibit 40, # 41 Exhibit 41, # 42 Exhibit 42-1, # 43 Exhibit 42-2, # 44 Exhibit 42-3, # 45 Exhibit 43, # 46 Exhibit 44-1, # 47 Exhibit 44-2, # 48 Exhibit 44-3, # 49 Exhibit 44-4, # 50 Exhibit 45, # 51 Exhibit 46, # 52 Exhibit 47, # 53 Exhibit 48, # 54 Exhibit 49, # 55 Exhibit 50, # 56 Exhibit 51, # 57 Exhibit 52, # 58 Exhibit 53, # 59 Exhibit 54, # 60 Exhibit 55, # 61 Exhibit 56, # 62 Exhibit 57, # 63 Exhibit 58, # 64 Exhibit 59, # 65 Exhibit 60, # 66 Exhibit 61, # 67 Exhibit 62, # 68 Exhibit 63, # 69 Exhibit 64, # 70 Exhibit 65, # 71 Exhibit 66, # 72 Exhibit 67, # 73 Exhibit 68, # 74 Exhibit 69, # 75 Exhibit 70, # 76 Exhibit 71, # 77 Exhibit 72)(Bartlett, Jason) (Filed on 11/28/2011) (Entered: 11/28/2011)
- 11/28/2011 424 REPLY (re 86 MOTION for Preliminary Injunction ) filed by Apple Inc.. (Bartlett, Jason) (Filed on 11/28/2011) (Entered: 11/28/2011)
- 11/28/2011 425 Declaration of Tony Blevins in Support of 424 Reply to Opposition/Response Declaration of Tony Blevins in Support of Apple's Motion for a Preliminary Injunction filed by Apple Inc.. (Attachments: # 1 Exhibit A, # 2 Exhibit B)(Related document(s) 424 ) (Bartlett, Jason) (Filed on 11/28/2011) (Entered: 11/28/2011)
- 11/28/2011 426 Reply Declaration of Sanjay Sood in Support of 86 Apple's Motion for a Preliminary Injunction filed by Apple Inc.. (Attachments: # 1 Exhibit A, # 2 Exhibit B, # 3 Exhibit C, # 4 Exhibit D, # 5 Exhibit E, # 6 Exhibit F, # 7 Exhibit G, # 8 Exhibit H, # 9 Exhibit I) (Related document(s) 424 ) (Bartlett, Jason) (Filed on 11/28/2011) Modified text on 11/29/2011 (dhm, COURT STAFF). (Entered: 11/28/2011)
- 11/28/2011 427 Declaration of Cooper C. Woodring in Support of 86 Apple's Motion for a Preliminary Injunction filed by Apple Inc.. (Attachments: # 1 Exhibit 1, # 2 Exhibit 2, # 3 Exhibit 3, # 4 Exhibit 4, # 5 Exhibit 5, # 6 Exhibit 6, # 7 Exhibit 7, # 8 Exhibit 8, # 9 Exhibit 9, # 10 Exhibit 10, # 11 Exhibit 11, # 12 Exhibit 12, # 13 Exhibit 13, # 14 Exhibit 14, # 15 Exhibit 15, # 16 Exhibit 16, # 17 Exhibit 17, # 18 Exhibit 18, # 19 Exhibit 19, # 20 Exhibit 20, # 21 Exhibit 21, # 22 Exhibit 22, # 23 Exhibit 23, # 24 Exhibit 24, # 25 Exhibit 25, # 26 Exhibit 26, # 27 Exhibit 27, # 28 Exhibit 28, # 29 Exhibit 29, # 30 Exhibit 30, # 31 Exhibit 31, # 32 Exhibit 32, # 33 Exhibit 33, # 34 Exhibit 34, # 35 Exhibit 35, # 36 Exhibit 36, # 37 Exhibit 37, # 38 Exhibit 38, # 39 Exhibit 39, # 40 Exhibit 40, # 41 Exhibit 41, # 42 Exhibit 42-1, # 43 Exhibit 42-2, # 44 Exhibit 42-3, # 45 Exhibit 43, # 46 Exhibit 44-1, # 47 Exhibit 44-2, # 48 Exhibit 44-3, # 49 Exhibit 44-4, # 50 Exhibit 45, # 51 Exhibit 46, # 52 Exhibit 47, # 53 Exhibit 48, # 54 Exhibit 49, # 55 Exhibit 50, # 56 Exhibit 51, # 57 Exhibit 52, # 58 Exhibit 53, # 59 Exhibit 54, # 60 Exhibit 55, # 61 Exhibit 56, # 62 Exhibit 57, # 63 Exhibit 58, # 64 Exhibit 59, # 65 Exhibit 60, # 66 Exhibit 61, # 67 Exhibit 62, # 68 Exhibit 63, # 69 Exhibit 64, # 70 Exhibit 65, # 71 Exhibit 66, # 72 Exhibit 67, # 73 Exhibit 68, # 74 Exhibit 69, # 75 Exhibit 70, # 76 Exhibit 71, # 77 Exhibit 72)(Related document(s) 424 ) (Bartlett, Jason)



- (Filed on 11/28/2011) Modified text on 11/29/2011 (dhm, COURT STAFF). (Entered: 11/28/2011)
- 11/29/2011 428 DOCUMENT E-FILED UNDER SEAL re 407 Order on Administrative Motion to File Under Seal Samsung's Opposition to Apple's Motion for a Preliminary Injunction by Samsung Electronics America, Inc., Samsung Electronics Co. Ltd., Samsung Telecommunications America, LLC. (Maroulis, Victoria) (Filed on 11/29/2011) (Entered: 11/29/2011)
- 11/29/2011 429 OPPOSITION to ( 86 Apple's MOTION for Preliminary Injunction ) filed by Samsung Electronics America, Inc., Samsung Electronics Co. Ltd., Samsung Telecommunications America, LLC. (Maroulis, Victoria) (Filed on 11/29/2011) Modified text on 11/30/2011 (dhm, COURT STAFF). (Entered: 11/29/2011)
- 11/29/2011 430 Declaration of Francis Ho in Support of 424 Apple's Reply in Support of its Motion for a Preliminary Injunction, filed by Apple Inc.. (Attachments: # 1 Exhibit A, # 2 Exhibit B, # 3 Exhibit C, # 4 Exhibit D, # 5 Exhibit E, # 6 Exhibit F-1, # 7 Exhibit F-2, # 8 Exhibit G, # 9 Exhibit H, # 10 Exhibit I, # 11 Exhibit J-1, # 12 Exhibit J-2, # 13 Exhibit K, # 14 Exhibit L-1, # 15 Exhibit L-2, # 16 Exhibit M, # 17 Exhibit N, # 18 Exhibit O, # 19 Exhibit P, # 20 Exhibit Q, # 21 Exhibit R, # 22 Exhibit S, # 23 Exhibit T, # 24 Exhibit U, # 25 Exhibit V, # 26 Exhibit W, # 27 Exhibit X, # 28 Exhibit Y, # 29 Exhibit Z, # 30 Exhibit AA, # 31 Exhibit BB, # 32 Exhibit CC, # 33 Exhibit DD, # 34 Exhibit EE, # 35 Exhibit FF, # 36 Exhibit GG, # 37 Exhibit HH, # 38 Exhibit II, # 39 Exhibit JJ, # 40 Exhibit KK, # 41 Exhibit LL)(Related document(s) 424 ) (Bartlett, Jason) (Filed on 11/29/2011) Modified text on 11/30/2011 (dhm, COURT STAFF). (Entered: 11/29/2011)
- 11/29/2011 431 DOCUMENT E-FILED UNDER SEAL re 407 Order on Administrative Motion to File Under Seal Declaration of Sara Jenkins in Support of Samsung's Opposition to Apple's Motion for a Preliminary Injunction by Samsung Electronics America, Inc., Samsung Electronics Co. Ltd., Samsung Telecommunications America, LLC. (Attachments: # 1 Exhibit M, # 2 Exhibit N-1, # 3 Exhibit N-2, # 4 Exhibit O, # 5 Exhibit P, # 6 Exhibit FF, # 7 Exhibit HH, # 8 Exhibit LL-1, # 9 Exhibit LL-2, # 10 Exhibit LL-3, # 11 Exhibit MM-1, # 12 Exhibit MM-2, # 13 Exhibit MM-3, # 14 Exhibit MM-4, # 15 Exhibit MM-5, # 16 Exhibit NN, # 17 Exhibit OO, # 18 Exhibit QQ)(Maroulis, Victoria) (Filed on 11/29/2011) (Entered: 11/29/2011)
- 11/29/2011 432 DOCUMENT E-FILED UNDER SEAL re 407 Order on Administrative Motion to File Under Seal Declaration of Michael J. Wagner in Support of Samsung's Opposition to Apple's Motion for a Preliminary Injunction by Samsung Electronics America, Inc., Samsung Electronics Co. Ltd., Samsung Telecommunications America, LLC. (Attachments: # 1 Exhibit A, # 2 Exhibit B, # 3 Exhibit C, # 4 Exhibit D, # 5 Exhibit E)(Maroulis, Victoria) (Filed on 11/29/2011) (Entered: 11/29/2011)
- 11/29/2011 433 DOCUMENT E-FILED UNDER SEAL re 407 Order on Administrative Motion to File Under Seal Declaration of Jeffrey Johnson, Ph.D., in Support of Samsung's Opposition to Apple's Motion for a Preliminary Injunction by Samsung Electronics America, Inc., Samsung Electronics Co. Ltd., Samsung Telecommunications America, LLC. (Attachments: # 1 Exhibit 3)(Maroulis, Victoria) (Filed on 11/29/2011) (Entered: 11/29/2011)
- 11/29/2011 434 Declaration of Jeffrey Johnson, Ph.D. in Support of 429 Opposition/Response to Motion, Declaration of Jeffrey Johnson, Ph.D., in Support of Samsung's Opposition to Apple's Motion for a Preliminary Injunction filed by Samsung Electronics America, Inc., Samsung Electronics Co. Ltd., Samsung Telecommunications America, LLC. (Attachments: # 1 Exhibit 1, # 2 Exhibit 2, # 3 Exhibit 3)(Related document(s) 429 ) (Maroulis, Victoria) (Filed on 11/29/2011) (Entered: 11/29/2011)
- 11/29/2011 435 DOCUMENT E-FILED UNDER SEAL re 406 Order on Administrative Motion to File Under Seal Samsung's Motion to Exclude Ordinary Observer Opinions of Apple Expert Cooper Woodring by Samsung Electronics America, Inc., Samsung Electronics Co. Ltd., Samsung Telecommunications America, LLC. (Johnson, Kevin) (Filed on 11/29/2011) (Entered: 11/29/2011)
- 11/29/2011 436 DOCUMENT E-FILED UNDER SEAL re 406 Order on Administrative Motion to File Under Seal Exhibits 1, 3, 5, and 8 to the Declaration of Michael Zeller (Dkt No. 177) in Support of Samsung's Motion to Exclude Ordinary Observer Opinions of Apple Expert Cooper Woodring (Dkt No. 176) -- (Main Document is Exhibit 1-1) by Samsung Electronics America, Inc., Samsung Electronics Co. Ltd., Samsung Telecommunications America, LLC. (Attachments: # 1 Exhibit 1-2, # 2 Exhibit 1-3, # 3 Exhibit 1-4, # 4 Exhibit 3, # 5 Exhibit 5-1, # 6 Exhibit 5-2, # 7 Exhibit 5-3, # 8 Exhibit 8)(Johnson, Kevin) (Filed on 11/29/2011) (Entered: 11/29/2011)
- 11/29/2011 437 MOTION SAMSUNG'S MOTION TO EXCLUDE ORDINARY OBSERVER OPINIONS OF APPLE EXPERT COOPER WOODRING (Public Redacted Version) filed by Samsung Electronics

America, Inc., Samsung Electronics Co. Ltd., Samsung Telecommunications America, LLC. Responses due by 9/6/2011. (Attachments: # 1 Proposed Order)(Johnson, Kevin) (Filed on 11/29/2011) (Entered: 11/29/2011)

- 11/29/2011 438 DOCUMENT E-FILED UNDER SEAL re 409 Order on Administrative Motion to File Under Seal Samsung's Reply in Support of its Motion to Exclude Ordinary Observer Opinions of Apple Expert Cooper Woodring by Samsung Electronics America, Inc., Samsung Electronics Co. Ltd., Samsung Telecommunications America, LLC. (Johnson, Kevin) (Filed on 11/29/2011) (Entered: 11/29/2011)
- 11/29/2011 439 REPLY (re 176 MOTION SAMSUNG'S NOTICE OF MOTION AND MOTION TO EXCLUDE ORDINARY OBSERVER OPINIONS OF APPLE EXPERT COOPER WOODRING; AND MEMORANDUM OF POINTS AND AUTHORITIES IN SUPPORT FILED UNDER SEAL ) Samsung's Reply in Support of its Motion to Exclude Ordinary Observer Opinions of Apple Expert Cooper Woodring (Public Redacted Version) filed by Samsung Electronics America, Inc., Samsung Electronics Co. Ltd., Samsung Telecommunications America, LLC. (Attachments: # 1 Supplemental Declaration of Michael Zeller, # 2 Exhibit 1, # 3 Exhibit 2, # 4 Exhibit 3)(Johnson, Kevin) (Filed on 11/29/2011) (Entered: 11/29/2011)
- 11/29/2011 440 DOCUMENT E-FILED UNDER SEAL re 409 Order on Administrative Motion to File Under Seal Exhibit 3 to the Supplemental Declaration of Michael Zeller (Dkt No. 439-1) in Support of Samsung's Reply in Support of its Motion to Exclude Ordinary Observer Opinions of Apple Expert Cooper Woodring by Samsung Electronics America, Inc., Samsung Electronics Co. Ltd., Samsung Telecommunications America, LLC. (Johnson, Kevin) (Filed on 11/29/2011) (Entered: 11/29/2011)
- 11/30/2011 441 OBJECTIONS to Samsung's Untimely New Evidence Regarding Preliminary Injunction Motion by Apple Inc.. (Attachments: # 1 Grant Kim Declaration (Public Redacted Version), # 2 Exhibit A, # 3 Exhibit B, # 4 Exhibit C, # 5 Exhibit D, # 6 Exhibit E (Redacted), # 7 Exhibit F, # 8 Exhibit G (Redacted), # 9 Exhibit H, # 10 Exhibit I, # 11 Exhibit J)(Jacobs, Michael) (Filed on 11/30/2011) (Entered: 11/30/2011)
- 11/30/2011 442 DOCUMENT E-FILED UNDER SEAL re 411 Order on Administrative Motion to File Under Seal Declaration of Grant L. Kim in Support of Apple's Objections to Samsung's Untimely New Evidence by Apple Inc.. (Attachments: # 1 Exhibit A, # 2 Exhibit B, # 3 Exhibit C, # 4 Exhibit D, # 5 Exhibit E, # 6 Exhibit F, # 7 Exhibit G, # 8 Exhibit H, # 9 Exhibit I, # 10 Exhibit J)(Jacobs, Michael) (Filed on 11/30/2011) (Entered: 11/30/2011)
- 12/01/2011 -- CLERKS NOTICE: The parties are advised to take notice of the new Standing Order Regarding Motions to File Under Seal in Civil Actions before U.S. District Judge Lucy H. Koh. THIS IS A TEXT ONLY DOCKET ENTRY, THERE IS NO DOCUMENT ASSOCIATED WITH THIS NOTICE (mpb, COURT STAFF) (Filed on 12/1/2011) (Entered: 12/01/2011)
- 12/01/2011 443 STIPULATION and [Proposed] Order Extending Briefing Schedule for Samsung's Motion to Dismiss Apple's Amended Counterclaims by Apple Inc.. (Attachments: # 1 Declaration) (Selwyn, Mark) (Filed on 12/1/2011) (Entered: 12/01/2011)
- 12/02/2011 444 Minute Entry: Telephonic hearing as to Discovery Dispute held in chambers on 12/2/2011 before Magistrate Judge Paul S. Grewal. Court to issue order after hearing. (Date Filed: 12/2/2011). (Court Reporter Not Reported.) (ofr, COURT STAFF) (Date Filed: 12/2/2011) (Entered: 12/02/2011)
- 12/02/2011 445 DOCUMENT E-FILED UNDER SEAL re 228 Order on Administrative Motion to File Under Seal (Declaration of K. Bridges in Support of Opposition to Motion to Disqualify) by Apple Inc.. (Taylor, Stephen) (Filed on 12/2/2011) (Entered: 12/02/2011)
- 12/02/2011 446 DOCUMENT E-FILED UNDER SEAL re 228 Order on Administrative Motion to File Under Seal (Declaration of T. Mavrakakis in Support of Opposition to Motion to Disqualify) by Apple Inc.. (Taylor, Stephen) (Filed on 12/2/2011) (Entered: 12/02/2011)
- 12/02/2011 447 ORDER RE: DECEMBER 2, 2011 DISCOVERY DISPUTE, re 444 Discovery Hearing,. Signed by Judge Paul S. Grewal on 12/2/2011. (ofr, COURT STAFF) (Filed on 12/2/2011) (Entered: 12/02/2011)
- 12/02/2011 448 DOCUMENT E-FILED UNDER SEAL re 228 Order on Administrative Motion to File Under Seal (Declaration of M. Pieja in Support of Opposition to Motion to Disqualify) by Apple Inc.. (Taylor, Stephen) (Filed on 12/2/2011) (Entered: 12/02/2011)
- 12/02/2011 449 FILED IN ERROR -- See refiled document ORDER by Judge Lucy H. Koh denying 86 Motion for Preliminary Injunction; denying 176 437 Motion to Exclude(lhklc2, COURT STAFF) (Filed on 12/2/2011) Modified on 12/2/2011 (lhklc2, COURT STAFF). (Entered: 12/02/2011)
- 12/02/2011 450 FILED IN ERROR ORDER Denying 86 MOTION for Preliminary Injunction filed by Apple

- Inc., re 176 MOTION SAMSUNG'S NOTICE OF MOTION AND MOTION TO EXCLUDE ORDINARY OBSERVER OPINIONS OF APPLE EXPERT COOPER WOODRING; 437 MOTION SAMSUNG'S MOTION TO EXCLUDE ORDINARY OBSERVER OPINIONS OF APPLE EXPERT COOPER WOODRING (Public Redacted Version. Signed by Judge Lucy H. Koh on 12/2/2011. (lhkic2, COURT STAFF) (Filed on 12/2/2011) Modified on 12/2/2011 (lhkic2, COURT STAFF). (Entered: 12/02/2011)
- 12/02/2011 451 DOCUMENT E-FILED UNDER SEAL by Court Staff.(Attachments: # 1 Certificate of Mailing -- Samsung, # 2 Certificate of Mailing -- Apple)(lhkic2, COURT STAFF) (Filed on 12/2/2011) (Entered: 12/02/2011)
- 12/02/2011 452 ORDER Denying 86 MOTION for Preliminary Injunction filed by Apple Inc., re 176 MOTION SAMSUNG'S NOTICE OF MOTION AND MOTION TO EXCLUDE ORDINARY OBSERVER OPINIONS OF APPLE EXPERT COOPER WOODRING; 437 MOTION SAMSUNG'S MOTION TO EXCLUDE ORDINARY OBSERVER OPINIONS OF APPLE EXPERT COOPER WOODRING (Public Redacted Version. Signed by Judge Lucy H. Koh on 12/2/2011. (lhkic2, COURT STAFF) Modified on 12/4/2011 (lhkic2, COURT STAFF). The Court filed preliminary injunction orders that were redacted pursuant to Civil L.R. 79-5. ECF Nos. 449, 450. Due to clerical error and a technological glitch, these versions of the order inadvertently did not properly mask the redacted information. The final corrected order, ECF No. 452, which is identical in substance to ECF Nos. 449 & 450, properly masks the redacted information and is the official Order of the Court on Apple's Motion for a Preliminary Injunction. (Entered: 12/03/2011)
- 12/05/2011 453 ORDER re 443 Stipulation filed by Apple Inc. Signed by Judge Lucy H. Koh on 12/5/2011. (lhkic2, COURT STAFF) (Filed on 12/5/2011) (Entered: 12/05/2011)
- 12/06/2011 454 NOTICE of Appearance by Victoria F. Maroulis Notice of Appearance by Rachel Herrick Kassabian (Maroulis, Victoria) (Filed on 12/6/2011) (Entered: 12/06/2011)
- 12/06/2011 459 ORDER GRANTING PLAINTIFF'S MOTION TO REMOVE INCORRECTLY FILED DOCUMENT: DOCKET NO. 247 by Judge Paul S. Grewal, granting 248 Motion to Remove Incorrectly Filed Document. (ofr, COURT STAFF) (Filed on 12/6/2011) (Entered: 12/08/2011)
- 12/07/2011 455 ORDER re 351 Unopposed Administrative Motion to File Under Seal filed by Apple Inc., 378 Administrative Motion to File Under Seal Samsung's Response to Apple's Supplemental Statement (Dkt No. 372) Administrative Motion to File Under Seal Samsung's Response to Apple's Supplemental Statement (Dkt No. 372) filed by Samsung Electronics Co. Ltd., Samsung Telecommunications America, LLC, Samsung Electronics America, Inc., 390 Administrative Motion to File Under Seal filed by Apple Inc., 340 Administrative Motion to File Under Seal Samsung's Opposition to Apple's Motion for a Protective Order filed by Samsung Electronics Co. Ltd., Samsung Telecommunications America, LLC, Samsung Electronics America, Inc. Signed by Judge Paul S. Grewal on 12/7/2011. (psglc2, COURT STAFF) (Filed on 12/7/2011) (Entered: 12/07/2011)
- 12/07/2011 456 Administrative Motion to File Under Seal filed by Samsung Electronics America, Inc.(a New York corporation), Samsung Electronics Co. Ltd., Samsung Telecommunications America, LLC(a Delaware limited liability company). (Attachments: # 1 Declaration Chan Declaration, # 2 Proposed Order, # 3 Exhibit Tung Declaration, # 4 Exhibit Exhibit A Tung Declaration, # 5 Exhibit Exhibit B Tung Declaration, # 6 Exhibit Exhibit C Tung Declaration, # 7 Exhibit Exhibit D Tung Declaration, # 8 Exhibit Exhibit E Tung Declaration, # 9 Exhibit Exhibit F Tung Declaration, # 10 Exhibit Exhibit G Tung Declaration, # 11 Exhibit Exhibit H Tung Declaration, # 12 Exhibit Exhibit I Tung Declaration, # 13 Exhibit Exhibit J Tung Declaration, # 14 Exhibit Exhibit K Tung Declaration, # 15 Exhibit Exhibit L Tung Declaration, # 16 Exhibit Exhibit M Tung Declaration, # 17 Exhibit Exhibit N Tung Declaration, # 18 Exhibit Exhibit O Tung Declaration, # 19 Exhibit Exhibit P Tung Declaration, # 20 Exhibit Exhibit Q Tung Declaration, # 21 Exhibit Exhibit R Tung Declaration, # 22 Exhibit Exhibit S Tung Declaration, # 23 Exhibit Exhibit T Tung Declaration, # 24 Exhibit Exhibit U Tung Declaration, # 25 Exhibit exhibit V Tung Declaration, # 26 Exhibit Exhibit W Tung Declaration, # 27 Exhibit Exhibit X Tung Declaration)(Maroulis, Victoria) (Filed on 12/7/2011) (Entered: 12/07/2011)
- 12/07/2011 457 CERTIFICATE OF SERVICE by Samsung Electronics America, Inc.(a New York corporation), Samsung Electronics Co. Ltd., Samsung Telecommunications America, LLC (a Delaware limited liability company) re 456 Administrative Motion to File Under Seal (Maroulis, Victoria) (Filed on 12/7/2011) (Entered: 12/07/2011)
- 12/07/2011 460 NOTICE OF APPEAL to the Federal Circuit as to 452 Order Denying Motion for Preliminary Injunction, by Apple Inc.(a California corporation). Filing fee \$ 455. Appeal Record due by 1/6/2012. (dhm, COURT STAFF) (Filed on 12/7/2011) (Additional attachment(s) added on 12/9/2011: # 1 Federal Circuit Court of Appeals Transmittal form) (dhm,

COURT STAFF). (Entered: 12/08/2011)

- 12/08/2011 458 Declaration of Rosa Kim in Support of 298 Administrative Motion to File Under Seal Unopposed Administrative Motion to File Apple's Motion to Augment Record and Supporting Documents Under Seal filed by Samsung Electronics America, Inc., Samsung Electronics Co. Ltd., Samsung Telecommunications America, LLC. (Attachments: # 1 Proposed Order)(Related document(s) 298 ) (Maroulis, Victoria) (Filed on 12/8/2011) (Entered: 12/08/2011)
- 12/08/2011 461 CLAIM CONSTRUCTION STATEMENT APPLES OPENING CLAIM CONSTRUCTION BRIEF PURSUANT TO PATENT L.R. 4-5 filed by Apple Inc.(a California corporation). (Jacobs, Michael) (Filed on 12/8/2011) (Entered: 12/08/2011)
- 12/08/2011 462 Declaration of DEOK KEUN Matthew Ahn IN SUPPORT OF 461 APPLES OPENING CLAIM CONSTRUCTION BRIEF PURSUANT TO PATENT L.R. 4-5 filed by Apple Inc.(a California corporation). (Attachments: # 1 Exhibit A, # 2 Exhibit B Part 1, # 3 Exhibit B Part 2, # 4 Exhibit C Part 1, # 5 Exhibit C Part 2, # 6 Exhibit D Part 1, # 7 Exhibit D Part 2, # 8 Exhibit D Part 3, # 9 Exhibit D Part 4, # 10 Exhibit E Part 1, # 11 Exhibit E Part 2, # 12 Exhibit F, # 13 Exhibit G, # 14 Exhibit H, # 15 Exhibit I, # 16 Exhibit J, # 17 Exhibit K, # 18 Exhibit L, # 19 Exhibit M Part 1, # 20 Exhibit M Part 2, # 21 Exhibit N, # 22 Exhibit O, # 23 Exhibit P, # 24 Exhibit Q)(Jacobs, Michael) (Filed on 12/8/2011) Modified on 12/9/2011 linking entry to document #461 (dhm, COURT STAFF). (Entered: 12/08/2011)
- 12/08/2011 463 ADMINISTRATIVE MOTION for Temporary Relief Regarding Lead Counsel Meet and Confer Requirement filed by Apple Inc.. Responses due by 12/12/2011. (Attachments: # 1 Declaration, # 2 Exhibit A, # 3 Exhibit B, # 4 Exhibit C, # 5 Exhibit D, # 6 Exhibit E, # 7 Proposed Order)(Jacobs, Michael) (Filed on 12/8/2011) Modified text on 12/9/2011 (dhm, COURT STAFF). (Entered: 12/08/2011)
- 12/08/2011 464 MOTION to Shorten Timefor Briefing and Hearing on Apple's Motion to Compel Production of Documents and Things, filed by Apple Inc.. (Attachments: # 1 Declaration, # 2 Exhibit A, # 3 Proposed Order)(Jacobs, Michael) (Filed on 12/8/2011) Modified text on 12/9/2011 (dhm, COURT STAFF). (Entered: 12/08/2011)
- 12/08/2011 465 Administrative Motion to File Under Seal SAMSUNG'S OPENING CLAIM CONSTRUCTION BRIEF filed by Samsung Electronics America, Inc.(a New York corporation), Samsung Electronics Co. Ltd., Samsung Telecommunications America, LLC(a Delaware limited liability company). (Maroulis, Victoria) (Filed on 12/8/2011) (Entered: 12/08/2011)
- 12/08/2011 466 Declaration of Brett Arnold in Support of 465 Administrative Motion to File Under Seal SAMSUNG'S OPENING CLAIM CONSTRUCTION BRIEF filed by Samsung Electronics America, Inc.(a New York corporation), Samsung Electronics Co. Ltd., Samsung Telecommunications America, LLC(a Delaware limited liability company). (Attachments: # 1 Exhibit 1, # 2 Exhibit 2a, # 3 Exhibit 2b, # 4 Exhibit 2c)(Related document(s) 465 ) (Maroulis, Victoria) (Filed on 12/8/2011) (Entered: 12/08/2011)
- 12/08/2011 467 Administrative Motion to File Under Seal filed by Apple Inc.. (Attachments: # 1 Exhibit Motion to Compel, # 2 Exhibit Mazza Declaration, # 3 Exhibit Ex. 1 to Mazza Decl, # 4 Exhibit Ex. 2 to Mazza Decl, # 5 Exhibit Ex. 3 to Mazza Decl, # 6 Exhibit Ex. 4 to Mazza Decl, # 7 Exhibit Ex. 5 to Mazza Decl, # 8 Exhibit Ex. 6 to Mazza Decl, # 9 Exhibit Ex. 7 to Mazza Decl, # 10 Exhibit Ex. 8 to Mazza Decl, # 11 Exhibit Ex. 9 to Mazza Decl, # 12 Exhibit Ex. 10 to Mazza Decl, # 13 Exhibit Ex. 11 to Mazza Decl, # 14 Exhibit Ex. 12 to Mazza Decl, # 15 Exhibit Ex. 13 to Mazza Decl, # 16 Exhibit Ex. 14 to Mazza Decl, # 17 Exhibit Ex. 15 to Mazza Decl, # 18 Exhibit Ex. 16 to Mazza Decl, # 19 Exhibit Ex. 17 to Mazza Decl, # 20 Exhibit Ex. 18 to Mazza Decl, # 21 Proposed Order)(Jacobs, Michael) (Filed on 12/8/2011) Modified on 12/15/2011 (feriab, COURT STAFF). (Attachment 10 replaced on 12/21/2011) (sp, COURT STAFF). (Attachment 16 replaced on 12/21/2011) (sp, COURT STAFF). PURSUANT TO ORDER 523 DOCUMENTS 467-10 AND 467-16 REMOVED. Modified on 12/21/2011 (sp, COURT STAFF). (Entered: 12/08/2011)
- 12/08/2011 468 EXHIBITS re 466 Declaration in Support, OF SAMSUNG'S ADMINISTRATIVE MOTION TO FILE UNDER SEAL filed by Samsung Electronics America, Inc.(a New York corporation), Samsung Electronics Co. Ltd., Samsung Telecommunications America, LLC(a Delaware limited liability company). (Attachments: # 1 Exhibit 3a, # 2 Exhibit 3b, # 3 Exhibit 3c, # 4 Exhibit 3d, # 5 Exhibit 3e, # 6 Exhibit 4)(Related document(s) 466 ) (Maroulis, Victoria) (Filed on 12/8/2011) (Entered: 12/08/2011)
- 12/08/2011 469 Proposed Order re 465 Administrative Motion to File Under Seal SAMSUNG'S OPENING CLAIM CONSTRUCTION BRIEF by Samsung Electronics America, Inc.(a New York corporation), Samsung Electronics Co. Ltd., Samsung Telecommunications America, LLC (a Delaware limited liability company). (Maroulis, Victoria) (Filed on 12/8/2011)

(Entered: 12/09/2011)

- 12/09/2011 470 CERTIFICATE OF SERVICE by Samsung Electronics America, Inc.(a New York corporation), Samsung Electronics Co. Ltd., Samsung Telecommunications America, LLC (a Delaware limited liability company) re 465 Administrative Motion to File Under Seal SAMSUNG'S OPENING CLAIM CONSTRUCTION BRIEF (Maroulis, Victoria) (Filed on 12/9/2011) (Entered: 12/09/2011)
- 12/09/2011 471 CERTIFICATE OF SERVICE by Apple Inc. (Jacobs, Michael) (Filed on 12/9/2011) (Entered: 12/09/2011)
- 12/09/2011 472 ORDER by Judge Lucy H. Koh granting 463 Motion for Temporary Relief from Meet and Confer Requirement (lhkic2, COURT STAFF) (Filed on 12/9/2011) (Entered: 12/09/2011)
- 12/09/2011 473 RESPONSE (re 464 MOTION to Shorten Time Apple's Motion to Shorten Time for Briefing and Hearing on Apple's Motion to Compel Production of Documents and Things ) filed by Samsung Electronics America, Inc., Samsung Electronics Co. Ltd., Samsung Telecommunications America, LLC. (Attachments: # 1 Declaration Declaration of Melissa N. Chan, # 2 Exhibit Exhibit 1 to the Chan Declaration, # 3 Exhibit Exhibit 2 to the Chan Declaration, # 4 Exhibit Exhibit 3 to the Chan Declaration, # 5 Proposed Order Proposed Order)(Maroulis, Victoria) (Filed on 12/9/2011) (Entered: 12/09/2011)
- 12/09/2011 474 DOCUMENT E-FILED UNDER SEAL re 455 Order,,,, Order Granting Motion to File Under Seal,,, Apple's Supplemental Statement Concerning Apple's Motion for a Protective Order by Apple Inc.. (Jacobs, Michael) (Filed on 12/9/2011) (Entered: 12/09/2011)
- 12/09/2011 475 DOCUMENT E-FILED UNDER SEAL re 455 Order,,,, Order Granting Motion to File Under Seal,,, Apple's Opposition to Samsung's Motion to Compel Apple to Produce Documents and Things by Apple Inc.. (Attachments: # 1 Hankey Declaration, # 2 Hankey Declaration Ex. A, # 3 Hankey Declaration Ex. B, # 4 Hoellwarth Declaration, # 5 Jacobs Declaration, # 6 Jacobs Declaration Ex. A, # 7 Overson Declaration, # 8 Olson Declaration, # 9 Olson Declaration Ex. 1, # 10 Olson Declaration Ex. 2, # 11 Olson Declaration Ex. 3, # 12 Olson Declaration Ex. 4, # 13 Olson Declaration Ex. 5, # 14 Olson Declaration Ex. 6, # 15 Olson Declaration Ex. 7, # 16 Olson Declaration Ex. 8, # 17 Olson Declaration Ex. 9)(Jacobs, Michael) (Filed on 12/9/2011) (Entered: 12/09/2011)
- 12/09/2011 476 DECLARATION of Erik J. Olson in Opposition to Samsung's Motion to Compel Apple to Produce Documents and Things filed by Apple Inc.. (Attachments: # 1 Exhibit 1, # 2 Exhibit 2, # 3 Exhibit 3, # 4 Exhibit 4, # 5 Exhibit 5, # 6 Exhibit 6, # 7 Exhibit 7, # 8 Exhibit 8, # 9 Exhibit 9)(Jacobs, Michael) (Filed on 12/9/2011) (Entered: 12/09/2011)
- 12/09/2011 477 ORDER by Judge Paul S. Grewal granting 464 Motion to Shorten Time (psglc2, COURT STAFF) (Filed on 12/9/2011) (Entered: 12/09/2011)
- 12/09/2011 478 NOTICE of Appearance by Esther Kim (Kim, Esther) (Filed on 12/9/2011) (Entered: 12/09/2011)
- 12/12/2011 479 MOTION for Leave to File Excess Pages re Samsung's Administrative Motion to Exceed Page Limit in Samsung's Responsive Claim Construction Brief filed by Samsung Electronics America, Inc., Samsung Electronics Co. Ltd., Samsung Telecommunications America, LLC. (Attachments: # 1 Briggs Declaration, # 2 Exhibit 1 to Briggs Declaration, # 3 Exhibit 2 to Briggs Declaration, # 4 Proposed Order)(Briggs, Todd) (Filed on 12/12/2011) (Entered: 12/12/2011)
- 12/12/2011 480 MOTION Temporary Relief Regarding Lead Counsel Meet and Confer Requirement filed by Samsung Electronics America, Inc., Samsung Electronics Co. Ltd., Samsung Telecommunications America, LLC. Responses due by 12/16/2011. (Attachments: # 1 Hutnyan Declaration, \*\*\* # 2 Exhibit 1 to Hutnyan Declaration FILED IN ERROR. DOCUMENT LOCKED. DOCUMENT TO BE REFILED LATER. \*\*\*) (Maroulis, Victoria) (Filed on 12/12/2011) Modified on 12/13/2011 (ewn, COURT STAFF). (Entered: 12/12/2011)
- 12/12/2011 481 MOTION to Shorten Time for Briefing and Hearing filed by Samsung Electronics America, Inc., Samsung Electronics Co. Ltd., Samsung Telecommunications America, LLC. (Attachments: # 1 Declaration of Diane Hutnyan, # 2 Proposed Order)(Maroulis, Victoria) (Filed on 12/12/2011) (Entered: 12/12/2011)
- 12/12/2011 482 MOTION To Permit Samsung's Expert Itay Sherman to Review Design Materials Designated Under the Protective Order filed by Samsung Electronics America, Inc., Samsung Electronics Co. Ltd., Samsung Telecommunications America, LLC. Responses due by 12/27/2011. Replies due by 1/3/2012. (Attachments: # 1 Declaration of Itay Sherman, # 2 Declaration of Rachel Herrick Kassabian, # 3 Proposed Order)(Maroulis, Victoria) (Filed on 12/12/2011) (Entered: 12/12/2011)

- 12/12/2011 483 Administrative Motion to File Under Seal Samsung's Motion to Compel filed by Samsung Electronics America, Inc., Samsung Electronics Co. Ltd., Samsung Telecommunications America, LLC. (Attachments: # 1 Hall Declaration, # 2 Proposed Order)(Maroulis, Victoria) (Filed on 12/12/2011) (Entered: 12/12/2011)
- 12/13/2011 484 OPPOSITION to (re 480 ADMINISTRATIVE MOTION for Relief Regarding Lead Counsel Meet and Confer Requirement ) filed by Apple Inc.. (Jacobs, Michael) (Filed on 12/13/2011) Modified text on 12/14/2011 (dhm, COURT STAFF). (Entered: 12/13/2011)
- 12/13/2011 485 Proposed Order re 480 MOTION Temporary Relief Regarding Lead Counsel Meet and Confer Requirement by Samsung Electronics America, Inc., Samsung Electronics Co. Ltd., Samsung Telecommunications America, LLC. (Maroulis, Victoria) (Filed on 12/13/2011) (Entered: 12/13/2011)
- 12/13/2011 486 Declaration of Mia Mazza In Support of 484 Apples Opposition to Samsungs Administrative Motion for Relief Regarding Lead Counsel Meet and Confer Requirement filed by Apple Inc.. (Attachments: # 1 Exhibit A, # 2 Exhibit B, # 3 Exhibit C)(Jacobs, Michael) (Filed on 12/13/2011) Modified on 12/14/2011 linking entry to document #484 (dhm, COURT STAFF). (Entered: 12/13/2011)
- 12/13/2011 487 EXHIBITS re 483 Administrative Motion to File Under Seal Samsung's Motion to Compel Proposed Public Redacted Version of Samsung's Motion to Compel and Supporting Documents filed by Samsung Electronics America, Inc., Samsung Electronics Co. Ltd., Samsung Telecommunications America, LLC. (Attachments: # 1 Hutnyan Declaration in support of Samsung's Motion to Compel, # 2 Exhibit 1, # 3 Exhibit 2, # 4 Exhibit 3, # 5 Exhibit 4, # 6 Exhibit 5, # 7 Exhibit 6, # 8 Exhibit 7, # 9 Exhibit 8, # 10 Exhibit 9, # 11 Exhibit 10, # 12 Exhibit 11, # 13 Exhibit 12, # 14 Exhibit 13, # 15 Exhibit 14, # 16 Exhibit 15, # 17 Exhibit 16, # 18 Exhibit 17, # 19 Exhibit 18, # 20 Exhibit 19, # 21 Exhibit 20, # 22 Exhibit 21, # 23 Exhibit 22, # 24 Exhibit 23, # 25 Proposed Order) (Related document(s) 483 ) (Maroulis, Victoria) (Filed on 12/13/2011) (Entered: 12/13/2011)
- 12/13/2011 488 CERTIFICATE OF SERVICE by Samsung Electronics America, Inc., Samsung Electronics Co. Ltd., Samsung Telecommunications America, LLC re 483 Administrative Motion to File Under Seal Samsung's Motion to Compel (Maroulis, Victoria) (Filed on 12/13/2011) (Entered: 12/13/2011)
- 12/13/2011 489 Proposed Order re 484 Opposition/Response to Motion, by Apple Inc.(a California corporation). (Kim, Esther) (Filed on 12/13/2011) (Entered: 12/13/2011)
- 12/13/2011 490 \*\*\* FILED IN ERROR. REFER TO DOCUMENT 493 . \*\*\* RESPONSE (re 481 MOTION to Shorten Time for Briefing and Hearing ) Apples Opposition to Samsungs Motion to Shorten Time filed by Apple Inc.. (Hung, Richard) (Filed on 12/13/2011) Modified on 12/13/2011 (feriab, COURT STAFF). (Entered: 12/13/2011)
- 12/13/2011 491 Declaration of Mia Mazza in Support of 493 Apples Opposition to Samsungs Motion to Shorten Time, filed by Apple Inc.. (Attachments: # 1 Exhibit A, # 2 Exhibit B, # 3 Exhibit C)(Hung, Richard) (Filed on 12/13/2011) Modified on 12/14/2011 linking entry to document #493 (dhm, COURT STAFF). (Entered: 12/13/2011)
- 12/13/2011 492 Proposed Order Denying in Part 481 Samsungs Motion to Shorten Time by Apple Inc.. (Hung, Richard) (Filed on 12/13/2011) Modified on 12/14/2011 linking entry to document #481 (dhm, COURT STAFF). (Entered: 12/13/2011)
- 12/13/2011 493 CORRECTED OPPOSITION to ( 481 MOTION to Shorten Time for Briefing and Hearing ) filed by Apple Inc.. (Hung, Richard) (Filed on 12/13/2011) Modified text on 12/14/2011 (dhm, COURT STAFF). (Entered: 12/13/2011)
- 12/13/2011 494 Amended Declaration of Diane Hutnyan in Support of 480 MOTION Temporary Relief Regarding Lead Counsel Meet and Confer Requirement filed by Samsung Electronics America, Inc., Samsung Electronics Co. Ltd., Samsung Telecommunications America, LLC. (Related document(s) 480 ) (Maroulis, Victoria) (Filed on 12/13/2011) Modified text on 12/14/2011 (dhm, COURT STAFF). (Entered: 12/13/2011)
- 12/13/2011 495 REPLY (re 481 MOTION to Shorten Time for Briefing and Hearing ) Reply in Support of Samsung's Motion to Shorten Time filed by Samsung Electronics America, Inc., Samsung Electronics Co. Ltd., Samsung Telecommunications America, LLC. (Maroulis, Victoria) (Filed on 12/13/2011) (Entered: 12/13/2011)
- 12/13/2011 496 OPPOSITION to ( 479 ADMINISTRATIVE MOTION for Leave to Exceed Page Limit in Samsung's Responsive Claim Construction Brief ) filed by Apple Inc.. (Jacobs, Michael) (Filed on 12/13/2011) Modified text on 12/14/2011 (dhm, COURT STAFF). (Entered: 12/13/2011)

- 12/13/2011 497 Declaration of Deok Keun Matthew Ahn In Support of 496 Apple's Opposition to Samsung's Administrative Motion to Exceed Page Limit in Samsung's Responsive Claim Construction Brief, filed by Apple Inc.. (Attachments: # 1 Exhibit A)(Jacobs, Michael) (Filed on 12/13/2011) Modified on 12/14/2011 linking entry to document (dhm, COURT STAFF). (Entered: 12/13/2011)
- 12/13/2011 498 ORDER by Judge Lucy H. Koh granting 480 Motion Regarding Temporary Relief from Meet and Confer Requirement (lhkic2, COURT STAFF) (Filed on 12/13/2011) Modified text on 12/14/2011 (dhm, COURT STAFF). (Entered: 12/13/2011)
- 12/13/2011 499 ORDER by Judge Paul S. Grewal granting 481 Motion to Shorten Time (psglc2, COURT STAFF) (Filed on 12/13/2011) (Entered: 12/13/2011)
- 12/14/2011 500 CLERKS NOTICE RESETTING DISCOVERY MOTIONS, RE: Docket Nos. [( 467 ), ( 482 ) and ( 483 )]. Motions set for 12/16/2011 at 10:00 AM in Courtroom 5, 4th Floor, San Jose before Magistrate Judge Paul Singh Grewal. \*\*\*THIS IS A TEXT ONLY DOCKET ENTRY, THERE IS NO DOCUMENT ASSOCIATED WITH THIS NOTICE\*\*\* (ofr, COURT STAFF) (Filed on 12/14/2011) (Entered: 12/14/2011)
- 12/15/2011 501 Administrative Motion to File Under Seal filed by Samsung Electronics America, Inc., Samsung Electronics Co. Ltd., Samsung Telecommunications America, LLC. (Attachments: # 1 Proposed Order to file under seal, # 2 Declaration of Melissa Chan In Support of Admin Motion, # 3 Declaration In Support of Samsung's Opposition, # 4 Exhibit 1 to Chan Declaration, # 5 Exhibit 2 to Chan Declaration, # 6 Exhibit 3 to Chan Declaration, # 7 Exhibit 4 to Chan Declaration, # 8 Exhibit 5 to Chan Declaration, # 9 Exhibit 6 to Chan Declaration, # 10 Exhibit 7 to Chan Declaration, # 11 Exhibit 8 to Chan Declaration, # 12 Exhibit 9 to Chan Declaration, # 13 Declaration 10 to Chan Declaration, # 14 Exhibit 11 to Chan Declaration, # 15 Exhibit 3 to Jenkins Declaration, # 16 Samsung's Opposition to Apple's Motion to Compel, # 17 Proposed Order Denying Apple's Motion to Compel, # 18 Certificate/Proof of Service)(Maroulis, Victoria) (Filed on 12/15/2011) (Entered: 12/15/2011)
- 12/15/2011 502 Administrative Motion to File Under Seal filed by Apple Inc.. (Attachments: # 1 Declaration, # 2 Proposed Order, # 3 Exhibit Apple's Opposition to Samsung's Motion to Compel, # 4 Mazza Decl ISO Apple's Opposition to Samsung's Motion to Compel, # 5 Ex. 1 to Mazza Decl ISO Apple's Opposition to Samsung's Motion to Compel, # 6 Ex. 2 to Mazza Decl ISO Apple's Opposition to Samsung's Motion to Compel, # 7 Proposed Order Denying Samsung's Motion to Compel, # 8 Apple's Opposition to Samsung's Motion to Permit Samsung's Expert Itay Sherman to Review Design Materials Designated Under the Protective Order, # 9 Kim Declaration ISO Apple's Opposition to Samsung's Motion to Permit Samsung's Expert Itay Sherman to Review Design Materials Designated Under the Protective Order, # 10 Ex. 1 to the Kim Declaration, # 11 Ex. 2 to the Kim Declaration, # 12 Ex. 3 to the Kim Declaration, # 13 Ex. 4 to the Kim Declaration, # 14 Ex. 5 to the Kim Declaration, # 15 Ex. 6 to the Kim Declaration, # 16 Ex. 7 to the Kim Declaration, # 17 Ex. 8 to the Kim Declaration, # 18 Ex. 9 to the Kim Declaration, # 19 Proposed Order Denying Samsung's Motion to Permit Samsung's Expert Itay Sherman to Review Design Materials Designated Under the Protective Order)(Hung, Richard) (Filed on 12/15/2011) (Entered: 12/15/2011)
- 12/15/2011 503 CERTIFICATE OF SERVICE by Apple Inc. (Hung, Richard) (Filed on 12/15/2011) (Entered: 12/15/2011)
- 12/15/2011 504 Administrative Motion to File Under Seal filed by Apple Inc.. (Attachments: # 1 Proposed Order)(Bartlett, Jason) (Filed on 12/15/2011) (Entered: 12/15/2011)
- 12/15/2011 505 CERTIFICATE OF SERVICE by Apple Inc. (Bartlett, Jason) (Filed on 12/15/2011) (Entered: 12/15/2011)
- 12/15/2011 506 Declaration of Melissa N. Chan in Support of 467 Administrative Motion to File Under Seal filed by Samsung Electronics America, Inc., Samsung Electronics Co. Ltd., Samsung Telecommunications America, LLC. (Attachments: # 1 Proposed Order)(Related document(s) 467 ) (Maroulis, Victoria) (Filed on 12/15/2011) (Entered: 12/15/2011)
- 12/15/2011 507 Transcript of Proceedings held on 10-13-11, before Judge Lucy H. Koh. Court Reporter/Transcriber Lee-Anne Shortridge, Telephone number 408-287-4580. Per General Order No. 59 and Judicial Conference policy, this transcript may be viewed only at the Clerks Office public terminal or may be purchased through the Court Reporter/Transcriber until the deadline for the Release of Transcript Restriction. After that date it may be obtained through PACER. Any Notice of Intent to Request Redaction, if required, is due no later than 5 business days from date of this filing. Release of Transcript Restriction set for 3/14/2012. (las, ) (Filed on 12/15/2011) (Entered: 12/15/2011)

- 12/15/2011 508 MOTION to Remove Incorrectly Filed Document Motion to Remove Incorrectly Filed Documents: Docket Nos. 467-10 and 467-16 filed by Apple Inc.. (Attachments: # 1 Proposed Order Proposed Order)(Bartlett, Jason) (Filed on 12/15/2011) (Entered: 12/15/2011)
- 12/16/2011 509 ORDER by Judge Lucy H. Koh denying 479 Motion for Leave to File Excess Pages (lhkic2, COURT STAFF) (Filed on 12/16/2011) (Entered: 12/16/2011)
- 12/16/2011 510 ORDER by Judge Lucy H. Koh granting in part and denying in part 298 Administrative Motion to File Under Seal (lhkic2, COURT STAFF) (Filed on 12/16/2011) (Entered: 12/16/2011)
- 12/16/2011 523 ORDER by Judge Paul S. Grewal granting 508 Motion to Remove Incorrectly Filed Document (psglc2, COURT STAFF) (Filed on 12/21/2011) Modified on 12/21/2011 (ofr, COURT STAFF). (Entered: 12/21/2011)
- 12/16/2011 539 Minute Entry: Motion Hearing held on 12/16/2011 before Magistrate Judge Paul S. Grewal (Date Filed: 12/16/2011) re 467 Administrative Motion to File Under Seal filed by Apple Inc., 483 Administrative Motion to File Under Seal Samsung's Motion to Compel filed by Samsung Electronics Co. Ltd., Samsung Telecommunications America, LLC, Samsung Electronics America, Inc., 482 MOTION To Permit Samsung's Expert Itay Sherman to Review Design Materials Designated Under the Protective Order filed by Samsung Electronics Co. Ltd., Samsung Telecommunications America, LLC, Samsung Electronics America, Inc. The Court takes matters under submission; written order after hearing to be issued. (Court Reporter Summer Fisher.) (ofr, COURT STAFF) (Date Filed: 12/16/2011) (Entered: 12/22/2011)
- 12/19/2011 511 DOCUMENT E-FILED UNDER SEAL re 410 Order on Administrative Motion to File Under Seal Corrected SEALED Exhibit C to the Declaration of Francis Ho in Support of Apple's Reply in Support of Its Motion for a Preliminary Injunction [correcting 417 Ex. C] by Apple Inc.. (Attachments: # 1 Part 2 to Exhibit C, # 2 Part 3 to Exhibit C)(Hung, Richard) (Filed on 12/19/2011) (Entered: 12/19/2011)
- 12/20/2011 512 DOCUMENT E-FILED UNDER SEAL re 455 Order,,,, Order Granting Motion to File Under Seal,,, Samsung's Opposition to Apple's Motion for a Protective Order by Samsung Electronics America, Inc., Samsung Electronics Co. Ltd., Samsung Telecommunications America, LLC. (Attachments: # 1 Arnold Declaration, # 2 Exhibit A, # 3 Exhibit B, # 4 Exhibit C, # 5 Exhibit D, # 6 Exhibit E, # 7 Exhibit F, # 8 Exhibit G, # 9 Exhibit H, # 10 Exhibit I, # 11 Exhibit J, # 12 Exhibit K, # 13 Exhibit L, # 14 Exhibit M, # 15 Exhibit N, # 16 Proposed Order)(Maroulis, Victoria) (Filed on 12/20/2011) (Entered: 12/20/2011)
- 12/20/2011 513 DOCUMENT E-FILED UNDER SEAL re 349 Order Granting Motion to File Under Seal, Samsung's Motion to Compel (e-filed under seal per Court Order at Dkt No 349) by Samsung Electronics America, Inc., Samsung Electronics Co. Ltd., Samsung Telecommunications America, LLC. (Attachments: # 1 Neill Declaration in Support of Samsung's Motion to Compel and its Motion to Shorten Time, # 2 Exhibit A, # 3 Exhibit B, # 4 Exhibit C, # 5 Exhibit D, # 6 Exhibit E, # 7 Exhibit F, # 8 Exhibit G, # 9 Exhibit H, # 10 Exhibit I, # 11 Exhibit J, # 12 Exhibit K, # 13 Exhibit L, # 14 Exhibit M, # 15 Proposed Order Granting Motion to Compel, # 16 Samsung's Motion to Shorten Time for Briefing and Hearing)(Maroulis, Victoria) (Filed on 12/20/2011) Modified text on 12/20/2011 (dhmS, COURT STAFF). (Entered: 12/20/2011)
- 12/20/2011 514 ORDER by Judge Lucy H. Koh denying 465 Administrative Motion to File Under Seal (lhkic2, COURT STAFF) (Filed on 12/20/2011) (Entered: 12/20/2011)
- 12/20/2011 515 ORDER by Judge Lucy H. Koh granting in part and denying in part 456 Administrative Motion to File Under Seal (lhkic2, COURT STAFF) (Filed on 12/20/2011) (Entered: 12/20/2011)
- 12/20/2011 516 Proposed Order re 513 Document E-Filed Under Seal,,, Proposed Order Granting Samsung's Motion to Shorten Time for Briefing and Hearing (Dkt No. 513-16) by Samsung Electronics America, Inc., Samsung Electronics Co. Ltd., Samsung Telecommunications America, LLC. (Maroulis, Victoria) (Filed on 12/20/2011) (Entered: 12/20/2011)
- 12/20/2011 517 DOCUMENT E-FILED UNDER SEAL re 455 Order,,,, Order Granting Motion to File Under Seal,,, Samsung's Response to Apple's Supplemental Statement (Dkt No. 372) by Samsung Electronics America, Inc., Samsung Electronics Co. Ltd., Samsung Telecommunications America, LLC. (Attachments: # 1 Arnold Declaration, # 2 Exhibit A, # 3 Exhibit B)(Johnson, Kevin) (Filed on 12/20/2011) (Entered: 12/20/2011)
- 12/20/2011 518 RESPONSE to re 372 to Apple's Supplemental Statement (Public Redacted Version) by Samsung Electronics America, Inc., Samsung Electronics Co. Ltd., Samsung



- Telecommunications America, LLC. (Attachments: # 1 Arnold Declaration, # 2 Exhibit A, # 3 Exhibit B)(Johnson, Kevin) (Filed on 12/20/2011) Modified text on 12/21/2011 (dhm, COURT STAFF). (Entered: 12/20/2011)
- 12/20/2011 519 Administrative Motion to File Under Seal Apples Motion to Augment Record on its Motion for Preliminary Injunction filed by Apple Inc.. (Attachments: # 1 Proposed Order Proposed Order Sealing 10-11 Motion to Augment)(Hung, Richard) (Filed on 12/20/2011) (Entered: 12/20/2011)
- 12/20/2011 520 MEMORANDUM OF POINTS AND AUTHORITIES IN OPPOSITION to ( 405 MOTION to Dismiss Apple's Amended Counterclaims ) filed by Apple Inc.(a California corporation). (Attachments: # 1 Proposed Order Proposed Order)(Selwyn, Mark) (Filed on 12/20/2011) Modified on 12/21/2011 (dhm, COURT STAFF). (Entered: 12/20/2011)
- 12/20/2011 521 Declaration of Mark D. Selwyn in Support of 520 Opposition/Response to Motion filed by Apple Inc.(a California corporation). (Attachments: # 1 Exhibit A, # 2 Exhibit B, # 3 Exhibit C, # 4 Exhibit D, # 5 Exhibit E, # 6 Exhibit F, # 7 Exhibit G, # 8 Exhibit H, # 9 Exhibit I, # 10 Exhibit J)(Related document(s) 520 ) (Selwyn, Mark) (Filed on 12/20/2011) (Entered: 12/20/2011)
- 12/20/2011 522 Declaration of Professor Nicolas Molfessis in Support of 520 Opposition/Response to Motion to Dismiss Apple's Counterclaims filed by Apple Inc.(a California corporation). (Attachments: # 1 Exhibit A, # 2 Exhibit B, # 3 Exhibit C)(Related document(s) 520 ) (Selwyn, Mark) (Filed on 12/20/2011) (Entered: 12/20/2011)
- 12/21/2011 524 ORDER by Judge Paul S. Grewal granting 504 Administrative Motion to File Under Seal (psglc2, COURT STAFF) (Filed on 12/21/2011) (Entered: 12/21/2011)
- 12/21/2011 525 ORDER by Judge Paul S. Grewal granting 502 Administrative Motion to File Under Seal (psglc2, COURT STAFF) (Filed on 12/21/2011) (Entered: 12/21/2011)
- 12/21/2011 526 ORDER by Judge Paul S. Grewal granting 501 Administrative Motion to File Under Seal (psglc2, COURT STAFF) (Filed on 12/21/2011) (Entered: 12/21/2011)
- 12/21/2011 527 ORDER Granting 483 Motion to File Under Seal. Signed by Judge Paul S. Grewal on 12/16/2011. (psglc2, COURT STAFF) (Filed on 12/21/2011) (Entered: 12/21/2011)
- 12/21/2011 528 ORDER Granting 467 Motion to File Under Seal. Signed by Judge Paul S. Grewal on 12/16/2011. (psglc2, COURT STAFF) (Filed on 12/21/2011) (Entered: 12/21/2011)
- 12/21/2011 529 DOCUMENT E-FILED UNDER SEAL re 510 Order on Administrative Motion to File Under Seal Exhibits A, B, C, and D to the Declaration of Minn Chung in Support of Apples Motion to Augment by Apple Inc.. (Attachments: # 1 Exhibit A - Part 2, # 2 Exhibit A - Part 3, # 3 Exhibit A - Part 4, # 4 Exhibit B - Part 1, # 5 Exhibit B - Part 2, # 6 Exhibit B - Part 3, # 7 Exhibit B - Part 4, # 8 Exhibit B - Part 5, # 9 Exhibit C - Part 1, # 10 Exhibit C - Part 2, # 11 Exhibit C - Part 3, # 12 Exhibit C - Part 4, # 13 Exhibit C - Part 5, # 14 Exhibit C - Part 6, # 15 Exhibit C - Part 7, # 16 Exhibit D)(Hung, Richard) (Filed on 12/21/2011) (Entered: 12/21/2011)
- 12/21/2011 530 MOTION for Reconsideration re 510 Order on Administrative Motion to File Under Seal Motion for Leave to File Motion for Reconsideration filed by Samsung Electronics America, Inc., Samsung Electronics Co. Ltd., Samsung Telecommunications America, LLC. (Attachments: # 1 Declaration Declaration of Hankil Kang, # 2 Proposed Order) (Maroulis, Victoria) (Filed on 12/21/2011) (Entered: 12/21/2011)
- 12/22/2011 531 MOTION to Shorten Time for Briefing and Hearing on Apple's Motion to Strike filed by Apple Inc.(a California corporation). (Attachments: # 1 Declaration of Mark D. Selwyn in Support of Motion to Shorten Time, # 2 Proposed Order)(Selwyn, Mark) (Filed on 12/22/2011) (Entered: 12/22/2011)
- 12/22/2011 532 Administrative Motion to File Under Seal Apple's Motion to Strike Evidence Not Disclosed as Required by Patent Local Rule 4-3(b) filed by Apple Inc.(a California corporation). (Attachments: # 1 Apple Inc.s Motion to Strike Evidence Not Disclosed as Required by Patent Local Rule 4-3(b), # 2 Declaration of Mark D. Selwyn in Support of Apples Motion to Strike, # 3 Exhibit A to Apple's Motion to Strike, # 4 Exhibit B to Apple's Motion to Strike, # 5 Proposed Order on Apple's Motion to Strike)(Selwyn, Mark) (Filed on 12/22/2011) (Entered: 12/22/2011)
- 12/22/2011 533 CERTIFICATE OF SERVICE by Apple Inc.(a California corporation) re 532 Administrative Motion to File Under Seal Apple's Motion to Strike Evidence Not Disclosed as Required by Patent Local Rule 4-3(b) Administrative Motion to File Under Seal Apple's Motion to Strike Evidence Not Disclosed as Required by Patent Local Rule 4-3(b) Administrative Motion to File Under Seal Apple's Motion to Strike Evidence Not Disclosed as Required by Patent Local Rule 4-3(b) (Selwyn, Mark) (Filed on 12/22/2011) (Entered: 12/22/2011)

- 12/22/2011 534 ORDER by Judge Lucy H. Koh granting 345 Motion to Amend/Correct (lhkic2, COURT STAFF) (Filed on 12/22/2011) (Entered: 12/22/2011)
- 12/22/2011 535 ORDER by Judge Paul S. Grewal granting in part and denying in part 482 Motion to Permit Expert Review of Designated Documents (psglc2, COURT STAFF) (Filed on 12/22/2011) (Entered: 12/22/2011)
- 12/22/2011 536 ORDER by Judge Paul S. Grewal granting in part and denying in part 483 Motion to Compel (psglc2, COURT STAFF) (Filed on 12/22/2011) (Entered: 12/22/2011)
- 12/22/2011 537 ORDER by Judge Paul S. Grewal granting in part and denying in part 467 Motion to Compel (psglc2, COURT STAFF) (Filed on 12/22/2011) (Entered: 12/22/2011)
- 12/22/2011 538 ORDER by Judge Lucy H. Koh granting 531 Motion to Shorten Time (lhkic2, COURT STAFF) (Filed on 12/22/2011) (Entered: 12/22/2011)
- 12/22/2011 540 Administrative Motion to File Under Seal Apple Inc.s Responsive Claim Construction Brief filed by Apple Inc.(a California corporation). (Attachments: # 1 Apple Inc.s Responsive Claim Construction Brief, # 2 Declaration of Mark D. Selwyn in Support of Apple Inc.s Responsive Claim Construction Brief, # 3 Exhibit A to Declaration of Mark D. Selwyn in Support of Apple Inc.s Responsive Claim Construction Brief, # 4 Exhibit B to Declaration of Mark D. Selwyn in Support of Apple Inc.s Responsive Claim Construction Brief, # 5 Exhibit C to Declaration of Mark D. Selwyn in Support of Apple Inc.s Responsive Claim Construction Brief, # 6 Exhibit D to Declaration of Mark D. Selwyn in Support of Apple Inc.s Responsive Claim Construction Brief, # 7 Exhibit E to Declaration of Mark D. Selwyn in Support of Apple Inc.s Responsive Claim Construction Brief, # 8 Exhibit F to Declaration of Mark D. Selwyn in Support of Apple Inc.s Responsive Claim Construction Brief, # 9 Exhibit G to Declaration of Mark D. Selwyn in Support of Apple Inc.s Responsive Claim Construction Brief, # 10 Exhibit H to Declaration of Mark D. Selwyn in Support of Apple Inc.s Responsive Claim Construction Brief, # 11 Exhibit I to Declaration of Mark D. Selwyn in Support of Apple Inc.s Responsive Claim Construction Brief, # 12 Exhibit J to Declaration of Mark D. Selwyn in Support of Apple Inc.s Responsive Claim Construction Brief, # 13 Exhibit K to Declaration of Mark D. Selwyn in Support of Apple Inc.s Responsive Claim Construction Brief, # 14 Exhibit L to Declaration of Mark D. Selwyn in Support of Apple Inc.s Responsive Claim Construction Brief, # 15 Exhibit M to Declaration of Mark D. Selwyn in Support of Apple Inc.s Responsive Claim Construction Brief, # 16 Exhibit N to Declaration of Mark D. Selwyn in Support of Apple Inc.s Responsive Claim Construction Brief, # 17 Exhibit O to Declaration of Mark D. Selwyn in Support of Apple Inc.s Responsive Claim Construction Brief, # 18 Exhibit P to Declaration of Mark D. Selwyn in Support of Apple Inc.s Responsive Claim Construction Brief, # 19 Exhibit Q to Declaration of Mark D. Selwyn in Support of Apple Inc.s Responsive Claim Construction Brief, # 20 Exhibit R to Declaration of Mark D. Selwyn in Support of Apple Inc.s Responsive Claim Construction Brief, # 21 Exhibit S to Declaration of Mark D. Selwyn in Support of Apple Inc.s Responsive Claim Construction Brief)(Selwyn, Mark) (Filed on 12/22/2011) (Entered: 12/22/2011)
- 12/22/2011 541 CERTIFICATE OF SERVICE by Apple Inc.(a California corporation) re 540 Administrative Motion to File Under Seal Apple Inc.s Responsive Claim Construction Brief (Selwyn, Mark) (Filed on 12/22/2011) (Entered: 12/22/2011)
- 12/22/2011 542 Administrative Motion to File Under Seal re Samsung's Response to Apple's Opening Claim Construction Brief filed by Samsung Electronics Co. Ltd.. (Attachments: # 1 Declaration Declaration of Brian Mack in Support of Motion to Seal, # 2 Exhibit Samsung's Response to Apple's Opening Claim Construction Brief, # 3 Exhibit Declaration of Todd M. Briggs in Support of Samsung's Response to Apple's Opening Claim Construction Brief, # 4 Exhibit Exhibit A to Briggs Decl, # 5 Exhibit Exhibit B to Briggs Decl, # 6 Exhibit Exhibit C to Briggs Decl, # 7 Exhibit Exhibit D to Briggs Decl, # 8 Exhibit Exhibit E to Briggs Decl, # 9 Exhibit Exhibit F to Briggs Decl, # 10 Exhibit Exhibit G to Briggs Decl, # 11 Exhibit Exhibit H to Briggs Decl, # 12 Exhibit Exhibit I to Briggs Decl, # 13 Exhibit Exhibit J to Briggs Decl, # 14 Exhibit Exhibit K to Briggs Decl, # 15 Exhibit Exhibit L to Briggs Decl, # 16 Exhibit Exhibit M to Briggs Decl, # 17 Exhibit Exhibit N to Briggs Decl, # 18 Exhibit Exhibit O to Briggs Decl, # 19 Exhibit Exhibit P to Briggs Decl, # 20 Exhibit Exhibit Q to Briggs Decl, # 21 Exhibit Exhibit R to Briggs Decl, # 22 Exhibit Exhibit S to Briggs Decl, # 23 Exhibit Exhibit T to Briggs Decl, # 24 Exhibit Exhibit U to Briggs Decl, # 25 Exhibit Exhibit V to Briggs Decl, # 26 Exhibit Exhibit W to Briggs Decl, # 27 Exhibit Exhibit X to Briggs Decl, # 28 Proposed Order Proposed Order Granting Motion to Seal)(Maroulis, Victoria) (Filed on 12/22/2011) (Entered: 12/22/2011)
- 12/23/2011 543 CERTIFICATE OF SERVICE by Samsung Electronics Co. Ltd. re 542 Administrative Motion to File Under Seal re Samsung's Response to Apple's Opening Claim Construction Brief

- (Maroulis, Victoria) (Filed on 12/23/2011) (Entered: 12/23/2011)
- 12/23/2011 544 EXHIBITS re 515 Order on Administrative Motion to File Under Seal Exhibit E to the Tung Declaration in Support of Samsung's Notice of Lodging filed per L.R. 79-5(e) filed by Samsung Electronics America, Inc., Samsung Electronics Co. Ltd., Samsung Telecommunications America, LLC. (Related document(s) 515 ) (Maroulis, Victoria) (Filed on 12/23/2011) (Entered: 12/23/2011)
- 12/23/2011 545 EXHIBITS re 515 Order on Administrative Motion to File Under Seal Exhibit G to the Tung Declaration in Support of Samsung's Notice of Lodging filed per L.R. 79-5(e) filed by Samsung Electronics America, Inc., Samsung Electronics Co. Ltd., Samsung Telecommunications America, LLC. (Related document(s) 515 ) (Maroulis, Victoria) (Filed on 12/23/2011) (Entered: 12/23/2011)
- 12/23/2011 546 EXHIBITS re 515 Order on Administrative Motion to File Under Seal Exhibit N to the Tung Declaration in Support of Samsung's Notice of Lodging filed per L.R. 79-5(e) filed by Samsung Electronics America, Inc., Samsung Electronics Co. Ltd., Samsung Telecommunications America, LLC. (Related document(s) 515 ) (Maroulis, Victoria) (Filed on 12/23/2011) (Entered: 12/23/2011)
- 12/23/2011 547 MOTION for Reconsideration re 515 Order on Administrative Motion to File Under Seal Motion for Leave to File Motion for Reconsideration filed by Samsung Electronics America, Inc., Samsung Electronics Co. Ltd., Samsung Telecommunications America, LLC. (Attachments: # 1 Declaration Declaration of Derrick Robinson, # 2 Exhibit Exhibit V (redacted version), # 3 Proposed Order Proposed Order)(Maroulis, Victoria) (Filed on 12/23/2011) (Entered: 12/23/2011)
- 12/27/2011 548 Administrative Motion to File Under Seal filed by Samsung Electronics America, Inc., Samsung Electronics Co. Ltd., Samsung Telecommunications America, LLC. (Attachments: # 1 Proposed Order, # 2 Declaration of Melissa N. Chan In Support of Samsung's Administrative Motion to File Documents Under Seal, # 3 Exhibit REDACTED Ex. X-1, # 4 Exhibit Ex. X-2, # 5 Exhibit REDACTED Ex. X-3, # 6 Exhibit REDACTED Ex. X-4, # 7 Exhibit Ex. X-5, # 8 Exhibit Ex. X-6, # 9 Exhibit REDACTED Ex. X-7, # 10 Exhibit REDACTED Ex. X-8, # 11 Exhibit Ex. X-9, # 12 Certificate/Proof of Service) (Maroulis, Victoria) (Filed on 12/27/2011) (Entered: 12/27/2011)
- 12/27/2011 549 DOCUMENT E-FILED UNDER SEAL re 510 Order on Administrative Motion to File Under Seal Corrected SEALED Exhibits B, C, and D to the Declaration of Minn Chung in Support of Apples Motion to Augment [Correcting 529] by Apple Inc.. (Attachments: # 1 SEALED Exhibit C, # 2 SEALED Exhibit D)(Hung, Richard) (Filed on 12/27/2011) (Entered: 12/27/2011)
- 12/28/2011 564 APPLICATION of Huan-Yi Lin for Admission Pro Hac Vice ( Filing fee \$ 305, receipt number 54611011072) filed by Samsung Electronics America, Inc.(a New York corporation), Samsung Electronics Co. Ltd., Samsung Telecommunications America, LLC (a Delaware limited liability company). (Attachments: # 1 Receipt)(dhm, COURT STAFF) (Filed on 12/28/2011) (Entered: 12/30/2011)
- 12/28/2011 572 Proposed Order re 564 APPLICATION of Huan-Yi Lin for Admission Pro Hac Vice ( Filing fee \$ 305, receipt number 54611011072.) by Samsung Electronics America, Inc.(a New York corporation), Samsung Electronics Co. Ltd., Samsung Telecommunications America, LLC(a Delaware limited liability company). (dhm, COURT STAFF) (Filed on 12/28/2011) (Entered: 01/04/2012)
- 12/28/2011 573 APPLICATION of John Caracappa for Admission Pro Hac Vice ( Filing fee \$ 305, receipt number 54611011072.) filed by Samsung Electronics America, Inc.(a New York corporation), Samsung Electronics Co. Ltd., Samsung Telecommunications America, LLC (a Delaware limited liability company). (dhm, COURT STAFF) (Filed on 12/28/2011) (Entered: 01/04/2012)
- 12/28/2011 574 Proposed Order re 573 APPLICATION of John Caracappa for Admission Pro Hac Vice ( Filing fee \$ 305, receipt number 54611011072.) by Samsung Electronics America, Inc. (a New York corporation), Samsung Electronics Co. Ltd., Samsung Telecommunications America, LLC(a Delaware limited liability company). (dhm, COURT STAFF) (Filed on 12/28/2011) (Entered: 01/04/2012)
- 12/28/2011 575 APPLICATION OF Thomas G. Pasternak for Admission Pro Hac Vice ( Filing fee \$ 305, receipt number 54611011072.) filed by Samsung Electronics America, Inc.(a New York corporation), Samsung Electronics Co. Ltd., Samsung Telecommunications America, LLC (a Delaware limited liability company). (dhm, COURT STAFF) (Filed on 12/28/2011) (Entered: 01/04/2012)
- 12/28/2011 576 Proposed Order re 575 APPLICATION OF Thomas G. Pasternak for Admission Pro Hac Vice

- ( Filing fee \$ 305, receipt number 54611011072.) by Samsung Electronics America, Inc. (a New York corporation), Samsung Electronics Co. Ltd., Samsung Telecommunications America, LLC(a Delaware limited liability company). (dhm, COURT STAFF) (Filed on 12/28/2011) (Entered: 01/04/2012)
- 12/29/2011 550 NOTICE of Appearance by Timothy S. Teter on behalf of Apple (Teter, Timothy) (Filed on 12/29/2011) (Entered: 12/29/2011)
- 12/29/2011 551 NOTICE of Appearance by Jesse L Dyer on behalf of Apple Inc. (Dyer, Jesse) (Filed on 12/29/2011) (Entered: 12/29/2011)
- 12/29/2011 552 NOTICE of Appearance by Benjamin George Damstedt on behalf of Apple Inc. (Damstedt, Benjamin) (Filed on 12/29/2011) (Entered: 12/29/2011)
- 12/29/2011 553 Declaration of Cyndi Wheeler in Support of 548 Administrative Motion to File Under Seal , 542 Administrative Motion to File Under Seal re Samsung's Response to Apple's Opening Claim Construction Brief - in Support of Samsungs Administrative Motions To File Documents Under Seal filed by Apple Inc.. (Attachments: # 1 Proposed Order Proposed Order)(Related document(s) 548 , 542 ) (Bartlett, Jason) (Filed on 12/29/2011) (Entered: 12/29/2011)
- 12/29/2011 554 MOTION for Extension of Time to Complete Discovery Samsung's Motion To Extend Time For Compliance With Certain Deadlines Set By The Court's Order (Dkt No. 537) filed by Samsung Electronics America, Inc., Samsung Electronics Co. Ltd., Samsung Telecommunications America, LLC. (Attachments: # 1 Declaration of Hankil Kang, # 2 Proposed Order)(Maroulis, Victoria) (Filed on 12/29/2011) (Entered: 12/29/2011)
- 12/29/2011 555 MOTION to Shorten Time for Briefing and Hearing 554 Samsung's Motion to Extend Time filed by Samsung Electronics America, Inc., Samsung Electronics Co. Ltd., Samsung Telecommunications America, LLC. (Attachments: # 1 Kassabian Declaration, # 2 Proposed Order)(Maroulis, Victoria) (Filed on 12/29/2011) Modified on 12/30/2011 linking entry to document #554 (dhm, COURT STAFF). (Entered: 12/29/2011)
- 12/29/2011 556 Administrative Motion to File Under Seal re Samsung's Reply Claim Construction Brief filed by Samsung Electronics Co. Ltd.. (Attachments: # 1 Declaration Arnold Declaration in Support of Samsung's Motion to Seal re Samsung's Reply Claim Construction Brief, # 2 Exhibit [Proposed] Public Redacted Version of Samsung's Reply Claim Construction Brief, # 3 Exhibit [Proposed] Public Redacted Version of Briggs Declaration in Support of Samsung's Reply Claim Construction Brief, # 4 Proposed Order [Proposed] Order) (Maroulis, Victoria) (Filed on 12/29/2011) (Entered: 12/29/2011)
- 12/29/2011 557 CERTIFICATE OF SERVICE by Samsung Electronics Co. Ltd. re 556 Administrative Motion to File Under Seal re Samsung's Reply Claim Construction Brief (Maroulis, Victoria) (Filed on 12/29/2011) (Entered: 12/29/2011)
- 12/29/2011 558 REPLY CLAIM CONSTRUCTION BRIEF to re 461 Claim Construction Statement Pursuant to Patent L.R. 4-5 by Apple Inc.. (Attachments: # 1 Declaration, # 2 Exhibit R, # 3 Exhibit S, # 4 Exhibit T, # 5 Exhibit U, # 6 Exhibit V)(Jacobs, Michael) (Filed on 12/29/2011) Modified text on 12/30/2011 (dhm, COURT STAFF). (Entered: 12/29/2011)
- 12/29/2011 559 Declaration of Deok Keun Matthew Ahn in Support of 558 Response ( Non Motion ), filed by Apple Inc.. (Attachments: # 1 Exhibit 1.01, # 2 Exhibit 1.02, # 3 Exhibit 1.03, # 4 Exhibit 1.04, # 5 Exhibit 1.05, # 6 Exhibit 1.06, # 7 Exhibit 1.07, # 8 Exhibit 1.08, # 9 Exhibit 1.09, # 10 Exhibit 1.10, # 11 Exhibit 1.11, # 12 Exhibit 1.12, # 13 Exhibit 1.13) (Related document(s) 558 ) (Jacobs, Michael) (Filed on 12/29/2011) (Entered: 12/29/2011)
- 12/29/2011 560 EXHIBITS re 559 Declaration in Support, filed by Apple Inc.. (Attachments: # 1 Exhibit 2.01, # 2 Exhibit 2.03, # 3 Exhibit 2.04, # 4 Exhibit 2.05, # 5 Exhibit 2.06, # 6 Exhibit 2.07, # 7 Exhibit 2.08, # 8 Exhibit 2.09, # 9 Exhibit 2.10, # 10 Exhibit 2.11)(Related document(s) 559 ) (Jacobs, Michael) (Filed on 12/29/2011) (Entered: 12/29/2011)
- 12/29/2011 561 Declaration in Support of 559 Declaration in Support, filed by Apple Inc.. (Attachments: # 1 Exhibit 3.02, # 2 Exhibit 3.03, # 3 Exhibit 3.04, # 4 Exhibit 3.05, # 5 Exhibit 3.06, # 6 Exhibit 3.07, # 7 Exhibit 3.08, # 8 Exhibit 3.09, # 9 Exhibit 3.10, # 10 Exhibit 3.11, # 11 Exhibit 3.12, # 12 Exhibit 3.13, # 13 Exhibit 3.14, # 14 Exhibit 3.15, # 15 Exhibit 3.16, # 16 Exhibit 3.17, # 17 Exhibit 3.18, # 18 Exhibit 3.19, # 19 Exhibit 3.20, # 20 Exhibit 3.21, # 21 Exhibit 3.22, # 22 Exhibit 3.23, # 23 Exhibit 3.24)(Related document (s) 559 ) (Jacobs, Michael) (Filed on 12/29/2011) (Entered: 12/29/2011)
- 12/29/2011 562 EXHIBITS re 559 Declaration in Support, filed by Apple Inc.. (Attachments: # 1 Exhibit 4.02, # 2 Exhibit 4.03, # 3 Exhibit 4.04, # 4 Exhibit 4.05, # 5 Exhibit 4.06, # 6 Exhibit 4.07, # 7 Exhibit 4.08, # 8 Exhibit 4.09, # 9 Exhibit 4.10, # 10 Exhibit 4.11, # 11 Exhibit 4.12, # 12 Exhibit 4.13, # 13 Exhibit 4.14, # 14 Exhibit 4.15, # 15 Exhibit 4.16,

- # 16 Exhibit 4.17, # 17 Exhibit 4.18, # 18 Exhibit 4.19, # 19 Exhibit 4.20, # 20 Exhibit 4.21, # 21 Exhibit 4.22, # 22 Exhibit 4.23, # 23 Exhibit 4.24)(Related document(s) 559 ) (Jacobs, Michael) (Filed on 12/29/2011) (Entered: 12/29/2011)
- 12/29/2011 563 EXHIBITS re 559 Declaration in Support, filed by Apple Inc.. (Attachments: # 1 Exhibit 5.02, # 2 Exhibit 5.03, # 3 Exhibit 5.04, # 4 Exhibit 5.05, # 5 Exhibit 5.06, # 6 Exhibit 5.07, # 7 Exhibit 5.08, # 8 Exhibit 5.09, # 9 Exhibit 5.10, # 10 Exhibit 5.11, # 11 Exhibit 6.1, # 12 Exhibit 6.2, # 13 Exhibit 6.3, # 14 Exhibit 6.4, # 15 Exhibit 6.5) (Related document(s) 559 ) (Jacobs, Michael) (Filed on 12/29/2011) (Entered: 12/29/2011)
- 12/29/2011 577 AMENDED APPLICATION of Thomas G. Pasternak for Admission Pro Hac Vice ( Filing fee \$ 305, receipt number 54611011072.) filed by Samsung Electronics America, Inc.(a New York corporation), Samsung Electronics Co. Ltd., Samsung Telecommunications America, LLC(a Delaware limited liability company). (dhm, COURT STAFF) (Filed on 12/29/2011) (Entered: 01/04/2012)
- 12/29/2011 578 Proposed Order re 577 AMENDED APPLICATION of Thomas G. Pasternak for Admission Pro Hac Vice ( Filing fee \$ 305, receipt number 54611011072.) by Samsung Electronics America, Inc.(a New York corporation), Samsung Electronics Co. Ltd., Samsung Telecommunications America, LLC(a Delaware limited liability company). (dhm, COURT STAFF) (Filed on 12/29/2011) (Entered: 01/04/2012)
- 12/29/2011 579 AMENDED APPLICATION of John Caracappa for Admission Pro Hac Vice ( Filing fee \$ 305, receipt number 54611011072.) filed by Samsung Electronics America, Inc.(a New York corporation), Samsung Electronics Co. Ltd., Samsung Telecommunications America, LLC (a Delaware limited liability company). (dhm, COURT STAFF) (Filed on 12/29/2011) (Entered: 01/04/2012)
- 12/29/2011 580 Proposed Order re 579 AMENDED APPLICATION of John Caracappa for Admission Pro Hac Vice( Filing fee \$ 305, receipt number 54611011072.) by Samsung Electronics America, Inc.(a New York corporation), Samsung Electronics Co. Ltd., Samsung Telecommunications America, LLC(a Delaware limited liability company). (dhm, COURT STAFF) (Filed on 12/29/2011) (Entered: 01/04/2012)
- 12/29/2011 581 AMENDED APPLICATION of Huan-Yi Lin for Admission Pro Hac Vice ( Filing fee \$ 305, receipt number 54611011072.) filed by Samsung Electronics America, Inc.(a New York corporation), Samsung Electronics Co. Ltd., Samsung Telecommunications America, LLC (a Delaware limited liability company). (dhm, COURT STAFF) (Filed on 12/29/2011) (Entered: 01/04/2012)
- 12/29/2011 582 Proposed Order re 581 AMENDED APPLICATION of Huan-Yi Lin for Admission Pro Hac Vice ( Filing fee \$ 305, receipt number 54611011072.) by Samsung Electronics America, Inc.(a New York corporation), Samsung Electronics Co. Ltd., Samsung Telecommunications America, LLC(a Delaware limited liability company). (dhm, COURT STAFF) (Filed on 12/29/2011) (Entered: 01/04/2012)
- 12/30/2011 565 OPPOSITION to ( 554 MOTION for Extension of Time For Compliance With Certain Deadlines Set By The Court's Order (Dkt No. 537) ) filed by Apple Inc.. (Attachments: # 1 Declaration, # 2 Exhibit A, # 3 Exhibit B, # 4 Exhibit C, # 5 Exhibit D, # 6 Exhibit E, # 7 Exhibit F, # 8 Exhibit G, # 9 Proposed Order)(Jacobs, Michael) (Filed on 12/30/2011) Modified text on 1/4/2012 (dhm, COURT STAFF). (Entered: 12/30/2011)
- 12/30/2011 566 ORDER by Judge Paul S. Grewal granting 555 Motion to Shorten Time (psglc2, COURT STAFF) (Filed on 12/30/2011) (Entered: 12/30/2011)
- 12/30/2011 567 ORDER DENYING 554 Motion for Extension of Time to Complete Discovery entered by Magistrate Judge Paul Singh Grewal. (This is a text-only entry generated by the court. There is no document associated with this entry.) (Entered: 12/30/2011)
- 01/03/2012 568 MOTION to Remove Incorrectly Filed Document 480-2 filed by Samsung Electronics America, Inc., Samsung Electronics Co. Ltd., Samsung Telecommunications America, LLC. (Attachments: # 1 Proposed Order)(Maroulis, Victoria) (Filed on 1/3/2012) (Entered: 01/03/2012)
- 01/03/2012 569 Transcript of Proceedings held on 12/16/2011, before Judge Paul S. Grewal. Court Reporter/Transcriber Summer Fisher, Telephone number 408-288-6150. Per General Order No. 59 and Judicial Conference policy, this transcript may be viewed only at the Clerks Office public terminal or may be purchased through the Court Reporter/Transcriber until the deadline for the Release of Transcript Restriction. After that date it may be obtained through PACER. Any Notice of Intent to Request Redaction, if required, is due no later than 5 business days from date of this filing. Release of Transcript Restriction set for 4/2/2012. (Fisher, Summer) (Filed on 1/3/2012) (Entered: 01/03/2012)

- 01/03/2012)
- 01/04/2012 570 STIPULATION and Proposed Order Extending Deadline for Samsung to File Objections by Samsung Electronics America, Inc., Samsung Electronics Co. Ltd., Samsung Telecommunications America, LLC. (Attachments: # 1 Arnold Declaration)(Maroulis, Victoria) (Filed on 1/4/2012) (Entered: 01/04/2012)
- 01/04/2012 571 STIPULATION AND ORDER EXTENDING DEADLINE FOR SAMSUNG TO FILE OBJECTIONS TO THE COURT'S ORDER AT DOCKET NO. 535 re 570 Stipulation, filed by Samsung Electronics Co. Ltd., Samsung Telecommunications America, LLC, Samsung Electronics America, Inc. Signed by Judge Paul S. Grewal on January 4, 2012. (psglc1, COURT STAFF) (Filed on 1/4/2012) (Entered: 01/04/2012)
- 01/06/2012 583 ORDER by Judge Lucy H. Koh granting 581 Motion for Pro Hac Vice (lhkic2, COURT STAFF) (Filed on 1/6/2012) (Entered: 01/06/2012)
- 01/06/2012 584 ORDER by Judge Lucy H. Koh granting 579 Motion for Pro Hac Vice (lhkic2, COURT STAFF) (Filed on 1/6/2012) (Entered: 01/06/2012)
- 01/06/2012 585 ORDER by Judge Lucy H. Koh granting 577 Motion for Pro Hac Vice (lhkic2, COURT STAFF) (Filed on 1/6/2012) (Entered: 01/06/2012)
- 01/06/2012 586 ORDER by Judge Lucy H. Koh denying 568 Motion to Remove Incorrectly Filed Document (lhkic2, COURT STAFF) (Filed on 1/6/2012) (Entered: 01/06/2012)
- 01/06/2012 587 ORDER Regarding Apple's Sealing Motions. Signed by Judge Lucy H. Koh on 1/6/2012. (lhkic2, COURT STAFF) (Filed on 1/6/2012) (Entered: 01/06/2012)
- 01/06/2012 588 ORDER Directing Samsung to File Documents re 514 Order on Administrative Motion to File Under Seal, 465 Administrative Motion to File Under Seal SAMSUNG'S OPENING CLAIM CONSTRUCTION BRIEF filed by Samsung Electronics Co. Ltd., Samsung Telecommunications America, LLC, Samsung Electronics America, Inc. Signed by Judge Lucy H. Koh on 1/6/2011. (lhkic2, COURT STAFF) (Filed on 1/6/2012) (Entered: 01/06/2012)
- 01/06/2012 589 CLAIM CONSTRUCTION STATEMENT Samsung's Opening Claim Construction Brief (Unredacted Version) filed by Samsung Electronics Co. Ltd.. (Attachments: # 1 Exhibit Briggs Declaration and Ex. A-F in support of Samsung's Opening Claim Construction Brief, # 2 Exhibit Briggs Declaration Ex. G-I, # 3 Declaration Wesel Declaration in Support of Samsung's Proposed Claim Construction for US Patent No. 7,200,792, # 4 Declaration Cole Declaration in Support of Samsung's Proposed Claim Construction for US Patent No. 7,698,711, # 5 Exhibit Cole Decl. Ex. 1, # 6 Exhibit Cole Decl. Ex. 2, # 7 Exhibit Cole Decl. Ex. 3, # 8 Exhibit Cole Decl. Ex. 4, # 9 Exhibit Cole Decl. Ex. 5, # 10 Exhibit Cole Decl. Ex. 6, # 11 Exhibit Cole Decl. Ex. 7A-7G, # 12 Exhibit Cole Decl. Ex. 8, # 13 Exhibit Cole Decl. Ex. 9A-9C, # 14 Exhibit Cole Decl. Ex. 10, # 15 Exhibit Cole Decl. Ex. 11, # 16 Exhibit Cole Decl. Ex. 12)(Maroulis, Victoria) (Filed on 1/6/2012) (Entered: 01/06/2012)
- 01/06/2012 590 ORDER Regarding Samsung's Motions for Reconsideration. Signed by Judge Lucy H. Koh on 1/6/2012. (lhkic2, COURT STAFF) (Filed on 1/6/2012) (Entered: 01/06/2012)
- 01/08/2012 591 MOTION to Withdraw 556 Administrative Motion to File Under Seal re Samsung's Reply Claim Construction Brief (UNOPPOSED MOTION) filed by Samsung Electronics Co. Ltd.. Responses due by 1/23/2012. Replies due by 1/30/2012. (Attachments: # 1 Proposed Order)(Maroulis, Victoria) (Filed on 1/8/2012) (Entered: 01/08/2012)
- 01/09/2012 592 ORDER by Judge Lucy H. Koh granting 591 Motion to Withdraw 556 Administrative Motion to File Under Seal re Samsung's Reply Claim Construction Brief (lhkic2, COURT STAFF) (Filed on 1/9/2012) (Entered: 01/09/2012)
- 01/09/2012 593 ORDER by Judge Lucy H. Koh denying 542 Administrative Motion to File Under Seal (lhkic2, COURT STAFF) (Filed on 1/9/2012) (Entered: 01/09/2012)
- 01/09/2012 594 REPLY (re 405 MOTION to Dismiss Apple's Amended Counterclaims ) filed by Samsung Electronics America, Inc.(a New York corporation), Samsung Electronics Co. Ltd.(a Korean corporation), Samsung Telecommunications America, LLC(a Delaware limited liability company). (Attachments: # 1 Declaration of Remy Libchaber, # 2 Declaration of Alex Baxter, # 3 Exhibit 1 of Baxter Declaration, # 4 Exhibit 2 of Baxter Declaration, # 5 Exhibit 3 of Baxter Declaration, # 6 Exhibit 4 of Baxter Declaration)(Maroulis, Victoria) (Filed on 1/9/2012) (Entered: 01/09/2012)
- 01/09/2012 595 CLAIM CONSTRUCTION STATEMENT Samsung's Reply Claim Construction Brief filed by Samsung Electronics America, Inc.. (Attachments: # 1 Declaration Briggs Declaration in Support of Samsung's Reply Claim Construction Brief, # 2 Exhibit A, # 3 Exhibit B, # 4 Exhibit C, # 5 Exhibit D, # 6 Exhibit E, # 7 Exhibit F, # 8 Exhibit G, # 9 Exhibit H, # 10

- Exhibit I, # 11 Exhibit J)(Maroulis, Victoria) (Filed on 1/9/2012) (Entered: 01/09/2012)
- 01/09/2012 596 STIPULATION and [Proposed] Order Shortening Time On Schedule For Briefing and Hearing Discovery Motions by Apple Inc.. (Attachments: # 1 Declaration Declaration of Mia Mazza In Support of Stipulation Shortening Time On Schedule For Briefing and Hearing Discovery Motions)(Bartlett, Jason) (Filed on 1/9/2012) (Entered: 01/09/2012)
- 01/10/2012 597 Statement re 590 Order Statement of Non-Opposition Regarding Samsung's Motions to Reconsider Sealing Orders by Apple Inc.. (Hung, Richard) (Filed on 1/10/2012) (Entered: 01/10/2012)
- 01/10/2012 598 MOTION for Protective Order Regarding Samsung's First Rule 30(b)(6) Deposition Notice filed by Apple Inc.. Motion Hearing set for 1/18/2012 02:00 PM in Courtroom 5, 4th Floor, San Jose before Magistrate Judge Paul Singh Grewal. Responses due by 1/13/2012. (Attachments: # 1 McElhinny Declaration, # 2 Exhibit A, # 3 Exhibit B, # 4 Mazza Declaration, # 5 Exhibit A, # 6 Exhibit B, # 7 Exhibit C, # 8 Exhibit D, # 9 Proposed Order)(Jacobs, Michael) (Filed on 1/10/2012) (Entered: 01/10/2012)
- 01/10/2012 599 MOTION for Protective Order Apple's Motion for Entry of Protective Order Regarding Disclosure and Use of Discovery Materials filed by Apple Inc.. Motion Hearing set for 1/18/2012 02:00 PM before Magistrate Judge Paul Singh Grewal. Responses due by 1/13/2012. (Attachments: # 1 McElhinny Declaration, # 2 Exhibit A, # 3 Exhibit B, # 4 Mazza Declaration, # 5 Exhibit A, # 6 Maselli Declaration, # 7 Exhibit A, # 8 Exhibit B, # 9 Exhibit C, # 10 Exhibit D)(Jacobs, Michael) (Filed on 1/10/2012) (Entered: 01/10/2012)
- 01/10/2012 600 Administrative Motion to File Under Seal Apples Motion to Compel Discovery Relating to Its Affirmative Defenses and Counterclaims filed by Apple Inc.(a California corporation). (Attachments: \*\*\* # 1 Motion to Compel, # 2 Maselli Declaration PURSUANT TO ORDER 804 DOCUMENT REMOVED.\*\*\*, # 3 Ex A, # 4 Ex B, # 5 Ex C, # 6 Ex D, # 7 Ex E, # 8 Ex F, # 9 Ex G, # 10 Ex H, # 11 Ex I, # 12 Ex J, # 13 Ex K, # 14 Ex L, # 15 Ex M, # 16 Ex N, # 17 Ex O, # 18 Ex P, # 19 Ex Q, # 20 Ex R, # 21 Ex S, # 22 Ex T, # 23 Ex U, # 24 Ex V, # 25 Ex W, # 26 Ex X, # 27 Ex Y, # 28 Ex Z, # 29 Ex AA, # 30 Ex BB, # 31 Ex CC, # 32 Ex DD, # 33 Ex EE \*\*\* PURSUANT TO ORDER 804 DOCUMENT REMOVED. \*\*\* # 34, Ex FF #(35) Ex GG, # 36 Proposed Order)(Selwyn, Mark) (Filed on 1/10/2012) Modified on 1/11/2012 (ewn, COURT STAFF). Modified on 1/11/2012 (feriab, COURT STAFF). Modified on 1/11/2012 (ewn, COURT STAFF). (Attachment 1 replaced on 3/13/2012) (sp, COURT STAFF). (Attachment 2 replaced on 3/13/2012) (sp, COURT STAFF). (Attachment 33 replaced on 3/13/2012) (sp, COURT STAFF). Modified on 3/13/2012 (sp, COURT STAFF). Modified on 3/13/2012 (sp, COURT STAFF). Modified on 6/8/2012 (ofr, COURT STAFF). (Entered: 01/11/2012)
- 01/11/2012 601 CERTIFICATE OF SERVICE by Apple Inc.(a California corporation) re 600 Administrative Motion to File Under Seal Apples Motion to Compel Discovery Relating to Its Affirmative Defenses and Counterclaims (Selwyn, Mark) (Filed on 1/11/2012) (Entered: 01/11/2012)
- 01/11/2012 602 Administrative Motion to File Under Seal re Samsung's January 10, 2012 Filings filed by Samsung Electronics Co. Ltd.. (Attachments: # 1 Trac Declaration, # 2 Proposed Order) (Maroulis, Victoria) (Filed on 1/11/2012) (Entered: 01/11/2012)
- 01/11/2012 603 EXHIBITS re 602 Administrative Motion to File Under Seal re Samsung's January 10, 2012 Filings Exhibit 1 - [Proposed] Public Redacted Version of Samsung's Motion to Compel filed by Samsung Electronics Co. Ltd.(a Korean corporation). (Attachments: # 1 Exhibit Hutnyan Declaration, # 2 Exhibit A, # 3 Exhibit B, # 4 Exhibit C, # 5 Exhibit D, # 6 Exhibit E, # 7 Exhibit F, # 8 Exhibit G, # 9 Exhibit H, # 10 Exhibit I, # 11 Exhibit J, # 12 Exhibit K, # 13 Exhibit L, # 14 Exhibit M, # 15 Exhibit N, # 16 Exhibit O, # 17 Exhibit P, # 18 Exhibit Q, # 19 Exhibit R, # 20 Exhibit S, # 21 Exhibit T, # 22 Exhibit U, # 23 Exhibit V, # 24 Exhibit W, # 25 Exhibit X, # 26 Exhibit Y, # 27 Exhibit Z, # 28 Exhibit AA, # 29 Exhibit BB, # 30 Exhibit CC, # 31 Proposed Order)(Related document(s) 602 ) (Maroulis, Victoria) (Filed on 1/11/2012) (Entered: 01/11/2012)
- 01/11/2012 604 EXHIBITS re 602 Administrative Motion to File Under Seal re Samsung's January 10, 2012 Filings Exhibit 2 - [Proposed] Public Redacted Version of Samsung's Renewed Motion to Compel filed by Samsung Electronics Co. Ltd.. (Attachments: # 1 Declaration Trac Declaration, # 2 Declaration Hutnyan Declaration, # 3 Exhibit A, # 4 Exhibit B, # 5 Exhibit C, # 6 Exhibit D, # 7 Exhibit E, # 8 Exhibit F, # 9 Exhibit G, # 10 Proposed Order)(Related document(s) 602 ) (Maroulis, Victoria) (Filed on 1/11/2012) (Entered: 01/11/2012)
- 01/11/2012 605 EXHIBITS re 602 Administrative Motion to File Under Seal re Samsung's January 10, 2012 Filings Exhibit 3 - [Proposed] Public Redacted Version of Samsung's Motion to Enforce Orders filed by Samsung Electronics Co. Ltd.. (Attachments: # 1 Hutnyan

- Declaration, # 2 Exhibit A, # 3 Exhibit B, # 4 Exhibit C, # 5 Exhibit D, # 6 Exhibit E, # 7 Exhibit F, # 8 Exhibit G, # 9 Exhibit H, # 10 Exhibit I, # 11 Proposed Order)(Related document(s) 602 ) (Maroulis, Victoria) (Filed on 1/11/2012) (Entered: 01/11/2012)
- 01/11/2012 606 EXHIBITS re 602 Administrative Motion to File Under Seal re Samsung's January 10, 2012 Filings Exhibit 3 - [Proposed] Public Redacted Version of Samsung's Motion for Clarification filed by Samsung Electronics Co. Ltd.. (Attachments: # 1 Declaration, # 2 Exhibit A-J, # 3 Exhibit K, # 4 Exhibit L, # 5 Proposed Order)(Related document(s) 602 ) (Maroulis, Victoria) (Filed on 1/11/2012) (Entered: 01/11/2012)
- 01/11/2012 607 EXHIBITS re 602 Administrative Motion to File Under Seal re Samsung's January 10, 2012 Filings Exhibit 5 - [Proposed] Public Redacted Version of Samsung's Motion for Protective Order filed by Samsung Electronics Co. Ltd.. (Attachments: # 1 Hutnyan Declaration, # 2 Exhibit A, # 3 Exhibit B, # 4 Exhibit C, # 5 Exhibit D, # 6 Exhibit E, # 7 Exhibit F, # 8 Exhibit G, # 9 Exhibit H, # 10 Exhibit I, # 11 Exhibit J, # 12 Exhibit K, # 13 Exhibit L, # 14 Proposed Order)(Related document(s) 602 ) (Maroulis, Victoria) (Filed on 1/11/2012) (Entered: 01/11/2012)
- 01/11/2012 608 ERRATA re 603 Exhibits,,, Notice of Correction re Samsung's Motion to Compel by Samsung Electronics Co. Ltd.. (Maroulis, Victoria) (Filed on 1/11/2012) (Entered: 01/11/2012)
- 01/11/2012 609 CERTIFICATE OF SERVICE by Samsung Electronics Co. Ltd. re 602 Administrative Motion to File Under Seal re Samsung's January 10, 2012 Filings (Maroulis, Victoria) (Filed on 1/11/2012) (Entered: 01/11/2012)
- 01/11/2012 610 STIPULATION AND ORDER re 596 Stipulation, filed by Apple Inc. Signed by Judge Paul S. Grewal on 1/11/2012. (psglc2, COURT STAFF) (Filed on 1/11/2012) (Entered: 01/11/2012)
- 01/11/2012 611 MOTION to Compel Discovery Relating to Its Affirmative Defenses and Counterclaims Correction of Docket # 600 filed by Apple Inc.(a California corporation). Motion Hearing set for 1/18/2012 02:00 PM before Hon. Lucy H. Koh. Responses due by 1/17/2012. (Attachments: # 1 Declaration of Samuel J. Maselli Correction of Docket #[600-2], # 2 Exhibit EE Correction of Docket #[600-33])(Selwyn, Mark) (Filed on 1/11/2012) (Entered: 01/11/2012)
- 01/11/2012 612 MOTION to Remove Incorrectly Filed Document Docket No. 600 filed by Apple Inc.(a California corporation). (Attachments: # 1 Proposed Order)(Selwyn, Mark) (Filed on 1/11/2012) (Entered: 01/11/2012)
- 01/11/2012 613 Administrative Motion to File Under Seal filed by Apple Inc.. (Attachments: # 1 Apple's Motion to Compel Production of Documents and Things, # 2 Mazza Declaration ISO Apple's Motion to Compel, # 3 Ex A to Mazza Decl, # 4 Ex B to Mazza Decl, # 5 Ex C to Mazza Decl, # 6 Ex D to Mazza Decl, # 7 Ex E to Mazza Decl, # 8 Ex F to Mazza Decl, # 9 Ex G to Mazza Decl, # 10 Ex H to Mazza Decl, # 11 Ex I to Mazza Decl, # 12 Ex J to Mazza Decl, # 13 Ex K to Mazza Decl, # 14 Ex L to Mazza Decl, # 15 Ex M to Mazza Decl, # 16 Ex N to Mazza Decl, # 17 Proposed Order)(Jacobs, Michael) (Filed on 1/11/2012) Modified on 6/8/2012 (ofr, COURT STAFF). (Entered: 01/11/2012)
- 01/11/2012 614 Declaration of Harold J. McElhinny in Support of Apple's Motion to Compel Production of Documents and Things filed by Apple Inc.. (Attachments: # 1 Exhibit A, # 2 Exhibit B, # 3 Exhibit C, # 4 Exhibit D, # 5 Exhibit E, # 6 Exhibit F, # 7 Exhibit G, # 8 Exhibit H) (Jacobs, Michael) (Filed on 1/11/2012) (Entered: 01/11/2012)
- 01/11/2012 615 Declaration of Erik J. Olson in Support of Apple's Motion to Compel Production of Documents and Things filed by Apple Inc.. (Jacobs, Michael) (Filed on 1/11/2012) (Entered: 01/11/2012)
- 01/11/2012 616 Proposed Order Granting Apple's Motion to Compel Production of Documents and Things by Apple Inc.. (Jacobs, Michael) (Filed on 1/11/2012) (Entered: 01/11/2012)
- 01/12/2012 617 CERTIFICATE OF SERVICE by Apple Inc. (Jacobs, Michael) (Filed on 1/12/2012) (Entered: 01/12/2012)
- 01/12/2012 618 CLERKS NOTICE RESETTING HEARING ON DISCOVERY MOTIONS: 1/18/2012 Discovery Motions (In Re: Docket Nos 598 , 599 , 602 , 611 ) reset to 1/19/2012 at 10:00 AM in Courtroom 5, 4th Floor, San Jose before Magistrate Judge Paul Singh Grewal. \*\*\*This is a text only docket entry, there is no document associated with this notice\*\*\* . (ofr, COURT STAFF) (Filed on 1/12/2012) (Entered: 01/12/2012)
- 01/12/2012 619 Administrative Motion to File Under Seal (Renewed) filed by Apple Inc.. (Attachments: # 1 Declaration of Cyndi Wheeler In Support of Apple's Renewed Administrative Motion to File Documents Under Seal, # 2 Exhibit B to T. Briggs In Support of Samsung's



Response to Apple's Opening Claim Construction, # 3 Exhibit I to T. Briggs In Support of Samsung's Response to Apple's Opening Claim Construction, # 4 Exhibit J to T. Briggs In Support of Samsung's Response to Apple's Opening Claim Construction, # 5 Samsung's Response to Apple's Opening Claim Construction, # 6 Proposed Order [Proposed] Order Granting Apple's Renewed Administrative Motion to File Documents Under Seal)(Hung, Richard) (Filed on 1/12/2012) (Entered: 01/12/2012)

- 01/12/2012 620 CERTIFICATE OF SERVICE by Apple Inc. (Hung, Richard) (Filed on 1/12/2012) (Entered: 01/12/2012)
- 01/12/2012 621 OPPOSITION to ( 532 Apple's Motion to Strike Evidence Not Disclosed as Required by Patent Local Rule 4-3(b) ) filed by Samsung Electronics Co. Ltd.. (Attachments: # 1 Declaration of Todd M. Briggs, # 2 Exhibit A, # 3 Exhibit B, # 4 Exhibit C, # 5 Exhibit D, # 6 Exhibit E, # 7 Exhibit F, # 8 Exhibit G)(Briggs, Todd) (Filed on 1/12/2012) Modified text on 1/13/2012 (dhm, COURT STAFF). (Entered: 01/12/2012)
- 01/12/2012 622 Proposed Order re 621 Opposition/Response to Motion,, 532 Administrative Motion to File Under Seal Apple's Motion to Strike Evidence Not Disclosed as Required by Patent Local Rule 4-3(b) by Samsung Electronics Co. Ltd.. (Briggs, Todd) (Filed on 1/12/2012) (Entered: 01/12/2012)
- 01/13/2012 623 ORDER by Judge Lucy H. Koh denying 532 Administrative Motion to File Under Seal; denying 540 Administrative Motion to File Under Seal (lhkcl2, COURT STAFF) (Filed on 1/13/2012) (Entered: 01/13/2012)
- 01/13/2012 624 NOTICE of Appearance by Patrick J Zhang Notice of Appearance of Patrick Zhang (Zhang, Patrick) (Filed on 1/13/2012) (Entered: 01/13/2012)
- 01/13/2012 625 Proposed Order Permitting Use of Equipment in the Courtroom by Samsung Electronics America, Inc., Samsung Electronics Co. Ltd., Samsung Telecommunications America, LLC. (Maroulis, Victoria) (Filed on 1/13/2012) (Entered: 01/13/2012)
- 01/13/2012 626 ORDER PERMITTING USE OF EQUIPMENT IN THE COURTROOM. Signed by Judge Lucy H. Koh on 1/13/12. (mpb, COURT STAFF) (Filed on 1/13/2012) (Entered: 01/13/2012)
- 01/13/2012 627 MOTION to Strike 623 Order on Administrative Motion to File Under Seal, Evidence Not Disclosed as Required by Patent Local Rule 4-3(B), Refiled by Court Order (D.N. 623) filed by Apple Inc.(a California corporation). Responses due by 1/13/2012. (Attachments: # 1 Declaration of Mark D. Selwyn in Support of Apple's Motion to Strike, # 2 Exhibit A, # 3 Exhibit B, # 4 Proposed Order)(Selwyn, Mark) (Filed on 1/13/2012) (Entered: 01/13/2012)
- 01/13/2012 628 RESPONSE to re 623 Order on Administrative Motion to File Under Seal, Apple Inc.s Responsive Claim Construction Brief, Refiled by Court Order (D.N. 623) by Apple Inc.(a California corporation). (Attachments: # 1 Declaration of Mark D. Selwyn in Support of Apple's Responsive Claim Construction Brief, # 2 Exhibit A, # 3 Exhibit B, # 4 Exhibit C, # 5 Exhibit D, # 6 Exhibit E, # 7 Exhibit F, # 8 Exhibit G, # 9 Exhibit H, # 10 Exhibit I, # 11 Exhibit J, # 12 Exhibit K, # 13 Exhibit L, # 14 Exhibit M, # 15 Exhibit N, # 16 Exhibit O, # 17 Exhibit P, # 18 Exhibit Q, # 19 Exhibit R, # 20 Exhibit S)(Selwyn, Mark) (Filed on 1/13/2012) (Entered: 01/13/2012)
- 01/13/2012 629 (AMENDED) CLERKS NOTICE RESETTING HEARING ON DISCOVERY MOTIONS: 1/18/2012 Discovery Motions (In Re: Docket Nos 598 , 599 , 600 602 , 611 and 613 ) reset to 1/19/2012 at 10:00 AM in Courtroom 5, 4th Floor, San Jose before Magistrate Judge Paul Singh Grewal. \*\*\*This is a text only docket entry, there is no document associated with this notice\*\*\* (ofr, COURT STAFF) (Filed on 1/13/2012) (Entered: 01/13/2012)
- 01/16/2012 630 STIPULATION WITH PROPOSED ORDER re 610 Stipulation and Order to Enlarge Time for Briefing the Parties' Pending Discovery Motions filed by Samsung Electronics America, Inc., Samsung Electronics Co. Ltd., Samsung Telecommunications America, LLC. (Attachments: # 1 Declaration Declaration of Rachel Herrick Kassabian)(Maroulis, Victoria) (Filed on 1/16/2012) (Entered: 01/16/2012)
- 01/17/2012 631 OPPOSITION to ( 602 Administrative Motion to File Under Seal ( re Samsung's January 10, 2012 Filings ) Apple's Opposition to Samsung's Renewed Motion to Compel Discovery Relating to Mac OS 10.0, filed by Apple Inc.. (Attachments: # 1 Mazza Declaration, # 2 Bartlett Declaration, # 3 Exhibit A to Bartlett Declaration, # 4 Exhibit B to Bartlett Declaration, # 5 Proposed Order)(Jacobs, Michael) (Filed on 1/17/2012) Modified text on 1/18/2012 (dhm, COURT STAFF). (Entered: 01/17/2012)
- 01/17/2012 632 OPPOSITION to ( 602 Samsung's MOTION for a Protective Order Administrative Motion to File Under Seal ( re Samsung's January 10, 2012 Filings ) filed by Apple Inc.. (Attachments: # 1 Mazza Declaration, # 2 Bartlett Declaration, # 3 Ex. A to Bartlett

- Declaration, # 4 Proposed Order)(Jacobs, Michael) (Filed on 1/17/2012) Modified text on 1/18/2012 (dhm, COURT STAFF). (Entered: 01/17/2012)
- 01/17/2012 633 OPPOSITION to ( 602 Samsung's MOTION for Clarification Regarding the Court's December 22, 2011 Order re Samsung's January 10, 2012 Filings filed by Apple Inc.. (Attachments: # 1 Proposed Order)(Jacobs, Michael) (Filed on 1/17/2012) Modified text on 1/18/2012 (dhm, COURT STAFF). (Entered: 01/17/2012)
- 01/17/2012 634 Proposed Order Denying Samsung's Motion to Enforce Various Court Orders by Apple Inc.. (Jacobs, Michael) (Filed on 1/17/2012) (Entered: 01/17/2012)
- 01/17/2012 635 STIPULATION AND ORDER re 630 STIPULATION WITH PROPOSED ORDER to Enlarge Time for Briefing the Parties' Pending Discovery Motions filed by Samsung Electronics Co. Ltd., Samsung Telecommunications America, LLC, Samsung Electronics America, Inc. Signed by Judge Paul S. Grewal on 1/17/2011. (psglc2, COURT STAFF) (Filed on 1/17/2012) (Entered: 01/17/2012)
- 01/17/2012 636 DECLARATION in Opposition to 602 Administrative Motion to File Under Seal re Samsung's January 10, 2012 Filings Bartlett and Mazza Declarations in Support of Apple's Opposition to Samsung's Motion to Compel filed by Apple Inc.. (Attachments: # 1 Exhibit 1 to Bartlett Declaration, # 2 Exhibit 2 to Bartlett Declaration, # 3 Exhibit 3 to Bartlett Declaration, # 4 Exhibit 4 to Bartlett Declaration, # 5 Exhibit 5 to Bartlett Declaration, # 6 Exhibit 6 to Bartlett Declaration, # 7 Exhibit 7 to Bartlett Declaration, # 8 Exhibit 8 to Bartlett Declaration, # 9 Mazza Declaration, # 10 Exhibit A to Mazza Declaration, # 11 Proposed Order)(Related document(s) 602 ) (Hung, Richard) (Filed on 1/17/2012) (Entered: 01/17/2012)
- 01/17/2012 637 Administrative Motion to File Under Seal filed by Apple Inc.. (Attachments: # 1 Wheeler Declaration ISO Motion to Seal, # 2 Proposed Order ISO Motion to Seal, # 3 Bartlett Declaration ISO Opposition to Motion to Enforce, # 4 Ex A to Bartlett Decl, # 5 Ex B to Bartlett Decl, # 6 Ex C to Bartlett Decl, # 7 Ex D to Bartlett Decl, # 8 Ex E to Bartlett Decl, # 9 Ex F to Bartlett Decl, # 10 Ex G to Bartlett Decl, # 11 Ex H to Bartlett Decl, # 12 Ex I to Bartlett Decl, # 13 Ex J to Bartlett Decl, # 14 Ex K to Bartlett Decl, # 15 Opposition to Motion to Enforce, # 16 Maselli Decl ISO Opposition to Motion to Compel, # 17 Ex A Maselli Decl, # 18 Ex B Maselli Decl, # 19 Ex C Maselli Decl, # 20 Ex D Maselli Decl, # 21 Ex E Maselli Decl, # 22 Opposition to Motion to Compel, # 23 Mazza Declaration ISO Opposition to Motion for Clarification, # 24 Ex A Mazza Decl, # 25 Ex B Mazza Decl, # 26 Ex C Mazza Decl)(Jacobs, Michael) (Filed on 1/17/2012) (Entered: 01/17/2012)
- 01/17/2012 638 STIPULATION WITH PROPOSED ORDER re 535 Order on Motion for Miscellaneous Relief Stipulation to Enlarge Time filed by Samsung Electronics America, Inc., Samsung Electronics Co. Ltd., Samsung Telecommunications America, LLC. (Attachments: # 1 Arnold Declaration)(Maroulis, Victoria) (Filed on 1/17/2012) (Entered: 01/17/2012)
- 01/17/2012 639 OPPOSITION to ( 598 MOTION for Protective Order Regarding Samsung's First Rule 30(b) (6) Deposition Notice ) filed by Samsung Electronics America, Inc.(a New York corporation), Samsung Electronics Co. Ltd., Samsung Telecommunications America, LLC (a Delaware limited liability company). (Attachments: # 1 Affidavit Chan, # 2 Exhibit A, # 3 Exhibit B, # 4 Exhibit C, # 5 Exhibit D, # 6 Proposed Order)(Maroulis, Victoria) (Filed on 1/17/2012) Modified text on 1/18/2012 (dhm, COURT STAFF). (Entered: 01/17/2012)
- 01/17/2012 640 CERTIFICATE OF SERVICE by Apple Inc. re sealed documents (Jacobs, Michael) (Filed on 1/17/2012) Modified text on 1/18/2012 (dhm, COURT STAFF). (Entered: 01/17/2012)
- 01/17/2012 641 OPPOSITION to ( 599 Apple's MOTION for Entry of Protective Order Regarding Disclosure and Use of Discovery Materials ) filed by Samsung Electronics America, Inc.(a New York corporation), Samsung Electronics Co. Ltd., Samsung Telecommunications America, LLC (a Delaware limited liability company). (Attachments: # 1 Proposed Order)(Maroulis, Victoria) (Filed on 1/17/2012) Modified text on 1/18/2012 (dhm, COURT STAFF). (Entered: 01/17/2012)
- 01/17/2012 642 Administrative Motion to File Under Seal Samsung's Opposition to Apple's Motion to Compel Production of Documents and Things (Dkt No. 613) filed by Samsung Electronics America, Inc., Samsung Electronics Co. Ltd., Samsung Telecommunications America, LLC. (Attachments: # 1 Declaration in support of Motion to Seal, # 2 Proposed Order Granting Motion to Seal, # 3 Proposed Public Redacted Version of Samsung's Opposition to Apple's Motion to Compel Production of Documents and Things (Dkt No. 613), # 4 Redacted Chan Declaration, # 5 Exhibit 1 to Chan Declaration, # 6 Exhibit 2 to Chan Declaration, # 7 Exhibit 3 to Chan Declaration, # 8 Exhibit 4 to Chan Declaration) (Maroulis, Victoria) (Filed on 1/17/2012) (Entered: 01/17/2012)
- 01/17/2012 643 Administrative Motion to File Under Seal Samsung's Opposition to Apple's Motion to

- Compel Discovery Relating to Its Affirmative Defenses and Counterclaims (Dkt No. 600) filed by Samsung Electronics America, Inc., Samsung Electronics Co. Ltd., Samsung Telecommunications America, LLC. (Attachments: # 1 Declaration in Support of Motion to Seal, # 2 Proposed Order Granting Motion to Seal, # 3 Proposed Public Redacted Version of Samsung's Opposition to Apple's Motion to Compel, # 4 Redacted Kim Declaration, # 5 Redacted Chan Declaration, # 6 Exhibit 1, # 7 Exhibit 2, # 8 Exhibit 3, # 9 Exhibit 4, # 10 Exhibit 5-1, # 11 Exhibit 5-2, # 12 Exhibit 5-3, # 13 Exhibit 6, # 14 Exhibit 7, # 15 Exhibit 8, # 16 Exhibit 9, # 17 Exhibit 10, # 18 Exhibit 11, # 19 Exhibit 12)(Maroulis, Victoria) (Filed on 1/17/2012) (Entered: 01/17/2012)
- 01/17/2012 644 Proposed Order re 642 Administrative Motion to File Under Seal Samsung's Opposition to Apple's Motion to Compel Production of Documents and Things (Dkt No. 613) -- Proposed Order Denying Apple's Motion to Compel Production of Documents and Things (relates to Dkt No. 642-3) by Samsung Electronics America, Inc., Samsung Electronics Co. Ltd., Samsung Telecommunications America, LLC. (Maroulis, Victoria) (Filed on 1/17/2012) (Entered: 01/17/2012)
- 01/17/2012 645 Proposed Order Denying Apple's Motion to Compel Discovery Related to Its Affirmative Defenses and Counterclaims (relates to Dkt No. 643-3) by Samsung Electronics America, Inc., Samsung Electronics Co. Ltd., Samsung Telecommunications America, LLC. (Maroulis, Victoria) (Filed on 1/17/2012) (Entered: 01/17/2012)
- 01/17/2012 646 CERTIFICATE OF SERVICE by Samsung Electronics America, Inc., Samsung Electronics Co. Ltd., Samsung Telecommunications America, LLC (relates to Dkt Nos. 642 & 643 ) (Maroulis, Victoria) (Filed on 1/17/2012) Modified on 1/18/2012 linking entry to document #642, 643 (dhm, COURT STAFF). (Entered: 01/17/2012)
- 01/17/2012 647 Declaration of Melissa N. Chan in Support of 600 Administrative Motion to File Under Seal Apples Motion to Compel Discovery Relating to Its Affirmative Defenses and Counterclaims filed by Samsung Electronics America, Inc., Samsung Electronics Co. Ltd., Samsung Telecommunications America, LLC. (Attachments: # 1 Proposed Order)(Related document(s) 600 ) (Maroulis, Victoria) (Filed on 1/17/2012) (Entered: 01/17/2012)
- 01/17/2012 652 Minute Entry: Tutorial Hearing held on 1/17/2012 before Judge Lucy H. Koh (Date Filed: 1/17/2012). (Court Reporter Irene Rodriguez.) (mpb, COURT STAFF) (Date Filed: 1/17/2012) (Entered: 01/20/2012)
- 01/18/2012 648 Declaration of Cyndi Wheeler in Support of 602 Administrative Motion to File Under Seal re Samsung's January 10, 2012 Filings filed by Apple Inc.. (Attachments: # 1 Exhibit 1, # 2 Exhibit 2, # 3 Exhibit 3, # 4 Exhibit 4, # 5 Exhibit 5, # 6 Exhibit 6, # 7 Exhibit 7, # 8 Exhibit 8, # 9 Exhibit 9, # 10 Exhibit 10, # 11 Exhibit 11, # 12 Exhibit 12, # 13 Exhibit 13, # 14 Exhibit 14, # 15 Exhibit 15, # 16 Exhibit 16, # 17 Exhibit 17, # 18 Proposed Order)(Related document(s) 602 ) (Hung, Richard) (Filed on 1/18/2012) (Entered: 01/18/2012)
- 01/19/2012 649 ORDER by Judge Lucy H. Koh granting 619 Administrative Motion to File Under Seal (lhkic2, COURT STAFF) (Filed on 1/19/2012) (Entered: 01/19/2012)
- 01/19/2012 650 Joint Statement on Person of Ordinary Skill in the Art of Report Regarding Meet and Confer on Disputed Claim Termns re 461 Claim Construction Statement by Apple Inc.. (Jacobs, Michael) (Filed on 1/19/2012) Modified text on 1/23/2012 (dhm, COURT STAFF). (Entered: 01/19/2012)
- 01/19/2012 651 Declaration of Melissa N. Chan in Support of 613 Administrative Motion to File Under Seal filed by Samsung Electronics America, Inc., Samsung Electronics Co. Ltd., Samsung Telecommunications America, LLC. (Attachments: # 1 Proposed Order)(Related document(s) 613 ) (Maroulis, Victoria) (Filed on 1/19/2012) (Entered: 01/19/2012)
- 01/19/2012 653 APPLICATION of Samuel Calvin Walden for Admission Pro Hac Vice ( Filing fee \$ 305, receipt number 54611011166.) Filing fee paid on 1/19/2012 filed by Apple Inc.(a California corporation). (dhm, COURT STAFF) (Filed on 1/19/2012) (Entered: 01/23/2012)
- 01/19/2012 654 Proposed Order re 653 APPLICATION of Samuel Calvin Walden for Admission Pro Hac Vice ( Filing fee \$ 305, receipt number 54611011166.) Filing fee paid on 1/19/2012 by Apple Inc.(a California corporation). (dhm, COURT STAFF) (Filed on 1/19/2012) (Entered: 01/23/2012)
- 01/19/2012 655 Minute Entry: Discovery Motions Hearing (In Re: Docket Nos. 598 , 599 , 600 , 611 , 613 , 603 , 604 , 605 , 606 , and 607 held on 1/19/2012 before Magistrate Judge Paul S. Grewal. The Court takes matters under submission; written order after hearing to be issued. (Date Filed: 1/19/2012). (Court Reporter: Summer Fisher.) (ofr, COURT STAFF) (Date Filed: 1/19/2012) (Entered: 01/23/2012)

- 01/20/2012 689 Minute Entry: Claims Construction / Markman Hearing held on 1/20/2012 before Judge Lucy H. Koh (Date Filed: 1/20/2012). Further Case Management Conference set for 4/5/2012 01:30 PM in Courtroom 8, 4th Floor, San Jose. (Court Reporter Irene Rodriguez.) (mpb, COURT STAFF) (Date Filed: 1/20/2012) (Entered: 01/30/2012)
- 01/24/2012 656 Declaration of Cyndi Wheeler in Support of 643 Administrative Motion to File Under Seal Samsung's Opposition to Apple's Motion to Compel Discovery Relating to Its Affirmative Defenses and Counterclaims (Dkt No. 600) filed by Apple Inc.. (Related document(s) 643 ) (Hung, Richard) (Filed on 1/24/2012) (Entered: 01/24/2012)
- 01/24/2012 657 Transcript of Proceedings held on 01/19/2012, before Judge Paul S. Grewal. Court Reporter/Transcriber Summer Fisher, Telephone number 408-288-6150. Per General Order No. 59 and Judicial Conference policy, this transcript may be viewed only at the Clerks Office public terminal or may be purchased through the Court Reporter/Transcriber until the deadline for the Release of Transcript Restriction. After that date it may be obtained through PACER. Any Notice of Intent to Request Redaction, if required, is due no later than 5 business days from date of this filing. Release of Transcript Restriction set for 4/23/2012. (Fisher, Summer) (Filed on 1/24/2012) (Entered: 01/24/2012)
- 01/25/2012 658 First MOTION for Leave to Supplement Its Infringement Contentions filed by Samsung Electronics Co. Ltd.. (Attachments: # 1 Declaration in support, # 2 Exhibit A, # 3 Exhibit B, # 4 Exhibit C, # 5 Exhibit D, # 6 Exhibit E, # 7 Exhibit F, # 8 Exhibit G, # 9 Exhibit H, # 10 Exhibit I, # 11 Exhibit J, # 12 Exhibit K, # 13 Exhibit L, # 14 Proposed Order Granting Motion for Leave to Amend)(Maroulis, Victoria) (Filed on 1/25/2012) Modified text on 1/26/2012 (dhm, COURT STAFF). (Entered: 01/25/2012)
- 01/25/2012 659 First MOTION to Shorten Time on 658 Motion for Leave to Supplement Infringement Contentions filed by Samsung Electronics Co. Ltd.. (Attachments: # 1 Proposed Order Granting Motion to Shorten, # 2 Declaration in Support of Motion to Shorten, # 3 Exhibit A)(Maroulis, Victoria) (Filed on 1/25/2012) Modified text on 1/26/2012 (dhm, COURT STAFF). (Entered: 01/25/2012)
- 01/25/2012 660 Administrative Motion to File Under Seal Apple Inc.'s Notice of Motion and Motion for Partial Summary Judgment filed by Apple Inc.(a California corporation). (Attachments: # 1 Declaration Tierney Decl ISO Motion to Seal, # 2 Proposed Order Proposed Order Granting Apple's Motion to Seal, # 3 Motion for Partial Summary Judgment, # 4 Declaration Hieta Declaration ISO Motion for Partial Summary Judgment, # 5 Exhibit Hieta Decl Exhibit 1, # 6 Exhibit Hieta Decl Exhibit 2, # 7 Exhibit Hieta Decl Exhibit 3, # 8 Exhibit Hieta Decl Exhibit 4, # 9 Declaration Mueller Declaration ISO Motion for Partial Summary Judgment, # 10 Proposed Order Proposed Order Granting Partial Summary Judgment)(Selwyn, Mark) (Filed on 1/25/2012) (Entered: 01/25/2012)
- 01/25/2012 661 EXHIBITS re 660 Administrative Motion to File Under Seal Apple Inc.'s Notice of Motion and Motion for Partial Summary Judgment Exhibits to Mueller Declaration ISO Apple's Motion for Partial Summary Judgment [660-9] filed by Apple Inc.(a California corporation). (Attachments: # 1 Exhibit Mueller Decl Exhibit 2, # 2 Exhibit Mueller Decl Exhibit 3, # 3 Exhibit Mueller Decl Exhibit 4, # 4 Exhibit Mueller Decl Exhibit 5, # 5 Exhibit Mueller Decl Exhibit 6, # 6 Exhibit Mueller Decl Exhibit 7, # 7 Exhibit Mueller Decl Exhibit 8, # 8 Exhibit Mueller Decl Exhibit 9, # 9 Exhibit Mueller Decl Exhibit 10, # 10 Exhibit Mueller Decl Exhibit 11, # 11 Exhibit Mueller Decl Exhibit 12, # 12 Exhibit Mueller Decl Exhibit 13, # 13 Exhibit Mueller Decl Exhibit 14, # 14 Exhibit Mueller Decl Exhibit 15, # 15 Exhibit Mueller Decl Exhibit 16, # 16 Exhibit Mueller Decl Exhibit 17, # 17 Exhibit Mueller Decl Exhibit 18, # 18 Exhibit Mueller Decl Exhibit 19, # 19 Exhibit Mueller Decl Exhibit 20, # 20 Exhibit Mueller Decl Exhibit 21, # 21 Exhibit Mueller Decl Exhibit 22, # 22 Exhibit Mueller Decl Exhibit 23, # 23 Exhibit Mueller Decl Exhibit 24)(Related document(s) 660 ) (Selwyn, Mark) (Filed on 1/25/2012) (Entered: 01/25/2012)
- 01/25/2012 662 EXHIBITS re 660 Administrative Motion to File Under Seal Apple Inc.'s Notice of Motion and Motion for Partial Summary Judgment Exhibits to Mueller Declaration ISO Apple's Motion for Partial Summary Judgment [660-9] filed by Apple Inc.(a California corporation). (Attachments: # 1 Exhibit Mueller Decl Exhibit 26, # 2 Exhibit Mueller Decl Exhibit 27, # 3 Exhibit Mueller Decl Exhibit 28, # 4 Exhibit Mueller Decl Exhibit 29, # 5 Exhibit Mueller Decl Exhibit 30, # 6 Exhibit Mueller Decl Exhibit 31, # 7 Exhibit Mueller Decl Exhibit 32, # 8 Exhibit Mueller Decl Exhibit 33, # 9 Exhibit Mueller Decl Exhibit 34, # 10 Exhibit Mueller Decl Exhibit 35, # 11 Exhibit Mueller Decl Exhibit 36, # 12 Exhibit Mueller Decl Exhibit 37, # 13 Exhibit Mueller Decl Exhibit 38, # 14 Exhibit Mueller Decl Exhibit 39, # 15 Exhibit Mueller Decl Exhibit 40, # 16 Exhibit Mueller Decl Exhibit 41) (Related document(s) 660 ) (Selwyn, Mark) (Filed on 1/25/2012) (Entered: 01/25/2012)
- 01/25/2012 663 EXHIBITS re 660 Administrative Motion to File Under Seal Apple Inc.'s Notice of Motion

and Motion for Partial Summary Judgment Exhibits to Mueller Declaration ISO Apple's Motion for Partial Summary Judgment [660-9] filed by Apple Inc.(a California corporation). (Attachments: # 1 Exhibit Mueller Decl Exhibit 43, # 2 Exhibit Mueller Decl Exhibit 44, # 3 Exhibit Mueller Decl Exhibit 45, # 4 Exhibit Mueller Decl Exhibit 46, # 5 Exhibit Mueller Decl Exhibit 47, # 6 Exhibit Mueller Decl Exhibit 48, # 7 Exhibit Mueller Decl Exhibit 49, # 8 Exhibit Mueller Decl Exhibit 50, # 9 Exhibit Mueller Decl Exhibit 51, # 10 Exhibit Mueller Decl Exhibit 52, # 11 Exhibit Mueller Decl Exhibit 53, # 12 Exhibit Mueller Decl Exhibit 54, # 13 Exhibit Mueller Decl Exhibit 55, # 14 Exhibit Mueller Decl Exhibit 56, # 15 Exhibit Mueller Decl Exhibit 57, # 16 Exhibit Mueller Decl Exhibit 58, # 17 Exhibit Mueller Decl Exhibit 59, # 18 Exhibit Mueller Decl Exhibit 60, # 19 Exhibit Mueller Decl Exhibit 61, # 20 Exhibit Mueller Decl Exhibit 62, # 21 Exhibit Mueller Decl Exhibit 63, # 22 Exhibit Mueller Decl Exhibit 64, # 23 Exhibit Mueller Decl Exhibit 65) (Related document(s) 660 ) (Selwyn, Mark) (Filed on 1/25/2012) (Entered: 01/25/2012)

- 01/25/2012 664 CERTIFICATE OF SERVICE by Apple Inc.(a California corporation) re 660 Administrative Motion to File Under Seal Apple Inc.'s Notice of Motion and Motion for Partial Summary Judgment (Selwyn, Mark) (Filed on 1/25/2012) (Entered: 01/25/2012)
- 01/26/2012 665 ORDER by Judge Lucy H. Koh granting 659 Motion to Shorten Time (lhklc2, COURT STAFF) (Filed on 1/26/2012) (Entered: 01/26/2012)
- 01/26/2012 666 ORDER by Judge Lucy H. Koh granting 653 Motion for Pro Hac Vice (lhklc2, COURT STAFF) (Filed on 1/26/2012) (Entered: 01/26/2012)
- 01/26/2012 667 Administrative Motion to File Under Seal re Samsung's Motion to Supplement Invalidity Contentions filed by Samsung Electronics Co. Ltd.. (Attachments: # 1 Trac Declaration, # 2 Proposed Order)(Maroulis, Victoria) (Filed on 1/26/2012) (Entered: 01/26/2012)
- 01/26/2012 668 MOTION to Shorten Time re 667 Samsung's Motion to Supplement Invalidity Contentions filed by Samsung Electronics Co. Ltd.. (Attachments: # 1 Briggs Declaration, # 2 Proposed Order)(Maroulis, Victoria) (Filed on 1/26/2012) (Entered: 01/26/2012)
- 01/27/2012 669 CERTIFICATE OF SERVICE by Samsung Electronics Co. Ltd. re 667 Administrative Motion to File Under Seal re Samsung's Motion to Supplement Invalidity Contentions (Maroulis, Victoria) (Filed on 1/27/2012) (Entered: 01/27/2012)
- 01/27/2012 670 EXHIBITS re 667 Administrative Motion to File Under Seal re Samsung's Motion to Supplement Invalidity Contentions filed by Samsung Electronics Co. Ltd.. (Attachments: # 1 Proposed Order)(Related document(s) 667 ) (Maroulis, Victoria) (Filed on 1/27/2012) (Entered: 01/27/2012)
- 01/27/2012 671 EXHIBITS re 667 Administrative Motion to File Under Seal re Samsung's Motion to Supplement Invalidity Contentions (Baxter Declaration in Support of Samsung's Motion to Supplement Invalidity Contentions) filed by Samsung Electronics Co. Ltd.. (Attachments: # 1 Exhibit A, # 2 Exhibit B, # 3 Exhibit C, # 4 Exhibit D, # 5 Exhibit E, # 6 Exhibit F, # 7 Exhibit G, # 8 Exhibit H, # 9 Exhibit I, # 10 Exhibit J, # 11 Exhibit K, # 12 Exhibit L, # 13 Exhibit M, # 14 Exhibit N, # 15 Exhibit O, # 16 Exhibit P, # 17 Exhibit Q, # 18 Exhibit R, # 19 Exhibit S, # 20 Exhibit T, # 21 Exhibit U, # 22 Exhibit V, # 23 Exhibit W, # 24 Exhibit X)(Related document(s) 667 ) (Maroulis, Victoria) (Filed on 1/27/2012) (Entered: 01/27/2012)
- 01/27/2012 672 \*\*\* EXHIBIT 4 FILED IN ERROR WITH CONFIDENTIAL INFORMATION . DOCUMENT LOCKED. DOCUMENT TO BE REFILED LATER.. \*\*\* EXHIBITS re 667 Administrative Motion to File Under Seal re Samsung's Motion to Supplement Invalidity Contentions (Briggs Declaration in Support of Samsung's Motion to Supplement Invalidity Contentions) filed by Samsung Electronics Co. Ltd.. (Attachments: # 1 Exhibit 1, # 2 Exhibit 2, # 3 Exhibit 3, # 4 Exhibit 4, # 5 Exhibit 5, # 6 Exhibit 6, # 7 Exhibit 7, # 8 Exhibit 8, # 9 Exhibit 9, # 10 Exhibit 10, # 11 Exhibit 11)(Related document(s) 667 ) (Maroulis, Victoria) (Filed on 1/27/2012) Modified on 1/27/2012 (feriab, COURT STAFF). (Entered: 01/27/2012)
- 01/27/2012 673 ORDER by Judge Paul S. Grewal RE DISCOVERY MOTIONS: 598 Apple's Motion for Protective Order; 599 Apple's Motion for Protective Order; 607 Samsung's Motion for Protective Order; 611 Apple's Motion to Compel; 613 Apple's Motion to Compel; 603 Samsung's Motion to Compel; 604 Samsung's Renewed Motion to Compel; 605 Samsung's Motion to Enforce; 606 Samsung's Motion for Clarification (psglc2, COURT STAFF) (Filed on 1/27/2012) (Entered: 01/27/2012)
- 01/27/2012 674 MOTION to Remove Incorrectly Filed Document re Dkt No. 672-4 (Briggs Declaration Exhibit 4) filed by Samsung Electronics Co. Ltd.. (Attachments: # 1 Proposed Order) (Maroulis, Victoria) (Filed on 1/27/2012) (Entered: 01/27/2012)
- 01/27/2012 675 Administrative Motion to File Under Seal re Exhibit 4 to Briggs Declaration in Support of

- Samsung's Motion to Supplement Invalidity Contentions filed by Samsung Electronics Co. Ltd.. (Attachments: # 1 Baxter Declaration, # 2 [Proposed] Public Redacted Version, # 3 Proposed Order)(Maroulis, Victoria) (Filed on 1/27/2012) (Entered: 01/27/2012)
- 01/27/2012 676 CERTIFICATE OF SERVICE by Samsung Electronics Co. Ltd. re 675 Administrative Motion to File Under Seal re Exhibit 4 to Briggs Declaration in Support of Samsung's Motion to Supplement Invalidity Contentions (Maroulis, Victoria) (Filed on 1/27/2012) (Entered: 01/27/2012)
- 01/27/2012 677 MOTION for Leave to File Statement of Recent Decisions in Support of Its Claim Construction Positions filed by Apple Inc.(a California corporation). (Attachments: # 1 Exhibit A - [Proposed] Statement of Recent Decisions, # 2 Declaration of Mia Mazza ISO Request for Leave, # 3 Proposed Order Granting Request for Leave)(Jacobs, Michael) (Filed on 1/27/2012) (Entered: 01/27/2012)
- 01/27/2012 678 RESPONSE (re 668 MOTION to Shorten Time re 667 Samsung's Motion to Supplement Invalidity Contentions ) Opposition to Samsung's Motion to Shorten Time for Briefing and Hearing filed byApple Inc.. (Attachments: # 1 Proposed Order)(Hung, Richard) (Filed on 1/27/2012) (Entered: 01/27/2012)
- 01/27/2012 679 MOTION to Shorten Time Apple's Motion to Shorten Time for Briefing and Hearing on Apple's Motion to Compel Timely Production of Foreign-Language and Other Documents in Advance of Related Depositions filed by Apple Inc.. (Jacobs, Michael) (Filed on 1/27/2012) (Entered: 01/27/2012)
- 01/27/2012 680 Declaration of Mia Mazza in Support of 679 MOTION to Shorten Time Apple's Motion to Shorten Time for Briefing and Hearing on Apple's Motion to Compel Timely Production of Foreign-Language and Other Documents in Advance of Related Depositions filed byApple Inc.. (Related document(s) 679 ) (Jacobs, Michael) (Filed on 1/27/2012) (Entered: 01/27/2012)
- 01/27/2012 681 Proposed Order re 679 MOTION to Shorten Time Apple's Motion to Shorten Time for Briefing and Hearing on Apple's Motion to Compel Timely Production of Foreign-Language and Other Documents in Advance of Related Depositions by Apple Inc.. (Jacobs, Michael) (Filed on 1/27/2012) (Entered: 01/27/2012)
- 01/27/2012 682 MOTION to Compel Apple's Motion to Compel Timely Production of Foreign-Language and Other Documents in Advance of Related Depositions filed by Apple Inc.. Motion Hearing set for 2/1/2012 10:00 AM in Courtroom 5, 4th Floor, San Jose before Magistrate Judge Paul Singh Grewal. Responses due by 1/31/2012. (Jacobs, Michael) (Filed on 1/27/2012) (Entered: 01/27/2012)
- 01/27/2012 683 Declaration of Mia Mazza in Support of 682 MOTION to Compel Apple's Motion to Compel Timely Production of Foreign-Language and Other Documents in Advance of Related Depositions filed byApple Inc.. (Attachments: # 1 Exhibit A)(Related document(s) 682 ) (Jacobs, Michael) (Filed on 1/27/2012) (Entered: 01/27/2012)
- 01/27/2012 684 Proposed Order re 682 MOTION to Compel Apple's Motion to Compel Timely Production of Foreign-Language and Other Documents in Advance of Related Depositions by Apple Inc.. (Jacobs, Michael) (Filed on 1/27/2012) (Entered: 01/27/2012)
- 01/29/2012 685 RESPONSE (re 679 MOTION to Shorten Time Apple's Motion to Shorten Time for Briefing and Hearing on Apple's Motion to Compel Timely Production of Foreign-Language and Other Documents in Advance of Related Depositions ) filed bySamsung Electronics America, Inc.(a New York corporation), Samsung Electronics Co. Ltd., Samsung Telecommunications America, LLC(a Delaware limited liability company). (Attachments: # 1 Declaration Declaration of Joby Martin, # 2 Exhibit Exhibit 1 to the Declaration of Joby Martin, # 3 Exhibit Exhibit 2 to the Declaration of Joby Martin, # 4 Proposed Order Proposed Order Denying Apple's Motion to Shorten)(Maroulis, Victoria) (Filed on 1/29/2012) (Entered: 01/29/2012)
- 01/30/2012 686 ORDER by Judge Lucy H. Koh granting 677 Motion for Leave to File (lhkic2, COURT STAFF) (Filed on 1/30/2012) (Entered: 01/30/2012)
- 01/30/2012 687 PROTECTIVE ORDER REGARDING DISCLOSURE AND USE OF DISCOVERY MATERIALS. Signed by Judge Paul S. Grewal on 1/30/2012. (psglc2, COURT STAFF) (Filed on 1/30/2012) (Entered: 01/30/2012)
- 01/30/2012 688 ORDER GRANTING-IN-PART APPLE'S MOTION TO SHORTEN TIME FOR BRIEFING AND HEARING ON APPLE'S MOTION TO COMPEL TIMELY PRODUCTION by Judge Paul S. Grewal, granting in part 679 Motion to Shorten Time (ofr, COURT STAFF) (Filed on 1/30/2012) (Entered: 01/30/2012)
- 01/30/2012 690 STIPULATION WITH PROPOSED ORDER EXTENDING DEADLINE FOR APPLES OPPOSITION

- TO SAMSUNG'S MOTION FOR LEAVE TO AMEND ITS INFRINGEMENT CONTENTIONS filed by Apple Inc.. (Jacobs, Michael) (Filed on 1/30/2012) (Entered: 01/30/2012)
- 01/30/2012 691 MOTION to Permit Samsung's Expert Samuel Lucente to Review Materials Designated Under the Protective Order filed by Samsung Electronics America, Inc., Samsung Electronics Co. Ltd., Samsung Telecommunications America, LLC. Motion Hearing set for 2/7/2012 10:00 AM in Courtroom 5, 4th Floor, San Jose before Magistrate Judge Paul Singh Grewal. Responses due by 2/3/2012. Replies due by 2/6/2012. (Attachments: # 1 Declaration of Albert P. Bedecarre, # 2 Exhibit A, # 3 Exhibit B, # 4 Exhibit C, # 5 Exhibit D, # 6 Exhibit E, # 7 Exhibit F, # 8 Exhibit G, # 9 Exhibit H, # 10 Exhibit I, # 11 Exhibit J, # 12 Exhibit K, # 13 Exhibit L, # 14 Exhibit M, # 15 Proposed Order)(Maroulis, Victoria) (Filed on 1/30/2012) (Entered: 01/30/2012)
- 01/31/2012 692 MOTION to Shorten Time for Briefing and Hearing on Samsung's Motion to Permit Samsung's Expert Samuel Lucente to Review Materials Designated Under the Protective Order (Dkt No. 691) filed by Samsung Electronics America, Inc., Samsung Electronics Co. Ltd., Samsung Telecommunications America, LLC. (Attachments: # 1 Declaration of Brett Arnold, # 2 Exhibit A, # 3 Exhibit B, # 4 Proposed Order)(Maroulis, Victoria) (Filed on 1/31/2012) (Entered: 01/31/2012)
- 01/31/2012 693 ORDER by Judge Lucy H. Koh granting 690 Stipulation (lhkic2, COURT STAFF) (Filed on 1/31/2012) (Entered: 01/31/2012)
- 01/31/2012 694 ORDER by Judge Lucy H. Koh denying 668 Motion to Shorten Time (lhkic2, COURT STAFF) (Filed on 1/31/2012) (Entered: 01/31/2012)
- 01/31/2012 695 Request for Judicial Notice Regarding Apple's Claim Construction Positions on U.S. Patent No. 7,469,381, filed by Samsung Electronics Co. Ltd.. (Attachments: # 1 Exhibit 1, # 2 Exhibit 2, # 3 Exhibit 3)(Maroulis, Victoria) (Filed on 1/31/2012) Modified text on 2/1/2012 (dhm, COURT STAFF). (Entered: 01/31/2012)
- 01/31/2012 696 CERTIFICATE OF SERVICE by Samsung Electronics Co. Ltd. re 695 Request for Judicial Notice, Exhibit 3 (Maroulis, Victoria) (Filed on 1/31/2012) (Entered: 01/31/2012)
- 01/31/2012 697 Minute Entry: Discovery Hearing held on 1/31/2012 before Magistrate Judge Paul S. Grewal. Court to issue written order after hearing. (Date Filed: 1/31/2012). (Court Reporter FTR: (2:35 to 2:59.) (ofr, COURT STAFF) (Date Filed: 1/31/2012) (Entered: 01/31/2012)
- 01/31/2012 698 STIPULATION WITH PROPOSED ORDER Stipulation and Proposed Order Extending Deadline for Apple's Opposition to Samsung's Motion for Leave to Amend Its Infringement Contentions filed by Apple Inc.. (Jacobs, Michael) (Filed on 1/31/2012) (Entered: 01/31/2012)
- 01/31/2012 699 ORDER by Judge Paul S. Grewal Denying 692 Motion to Shorten Time and Vacating Hearing on Shortened Time as set by 688 (psglc2, COURT STAFF) (Filed on 1/31/2012) (Entered: 01/31/2012)
- 01/31/2012 700 MOTION to Compel Apple to Respond to Samsung's Requests for Admission filed by Samsung Electronics America, Inc., Samsung Electronics Co. Ltd., Samsung Telecommunications America, LLC. Motion Hearing set for 3/6/2012 10:00 AM in Courtroom 5, 4th Floor, San Jose before Magistrate Judge Paul Singh Grewal. Responses due by 2/14/2012. Replies due by 2/21/2012. (Attachments: # 1 Declaration of Scott Hall, # 2 Exhibit A, # 3 Exhibit B, # 4 Proposed Order)(Maroulis, Victoria) (Filed on 1/31/2012) (Entered: 01/31/2012)
- 02/01/2012 701 AMENDED NOTICE OF MOTION to Permit Samsung's Expert Samuel Lucente to Review Materials Designated Under the Protective Order filed by Samsung Electronics Co. Ltd.. Motion Hearing set for 3/6/2012 10:00 AM in Courtroom 5, 4th Floor, San Jose before Magistrate Judge Paul Singh Grewal. Responses due by 2/13/2012. Replies due by 2/21/2012. (Maroulis, Victoria) (Filed on 2/1/2012) Modified text on 2/2/2012 (dhm, COURT STAFF). (Entered: 02/01/2012)
- 02/01/2012 702 MOTION to Compel Apple's Re-Noticed Motion to Compel Timely Production of Foreign-Language and Other Documents in Advance of Related Depositions filed by Apple Inc.. Responses due by 2/15/2012. Replies due by 2/22/2012. (Jacobs, Michael) (Filed on 2/1/2012) (Entered: 02/01/2012)
- 02/01/2012 703 OBJECTIONS to re 695 Request for Judicial Notice, by Apple Inc.. (Jacobs, Michael) (Filed on 2/1/2012) (Entered: 02/01/2012)
- 02/01/2012 704 Transcript of Proceedings held on 01/17/2012, before Judge Koh. Court Reporter/Transcriber Irene L. Rodriguez, Telephone number (408)947-8160. Per General Order No. 59 and Judicial Conference policy, this transcript may be viewed only at the

Clerks Office public terminal or may be purchased through the Court Reporter/Transcriber until the deadline for the Release of Transcript Restriction. After that date it may be obtained through PACER. Any Notice of Intent to Request Redaction, if required, is due no later than 5 business days from date of this filing. Redaction Request due 2/22/2012. Redacted Transcript Deadline set for 3/5/2012. Release of Transcript Restriction set for 5/1/2012. (Rodriguez, Irene) (Filed on 2/1/2012) (Entered: 02/01/2012)

- 02/01/2012 705 Transcript of Proceedings held on 01/20/2012, before Judge Koh. Court Reporter/Transcriber Irene L. Rodriguez, Telephone number (408)947-8160. Per General Order No. 59 and Judicial Conference policy, this transcript may be viewed only at the Clerks Office public terminal or may be purchased through the Court Reporter/Transcriber until the deadline for the Release of Transcript Restriction. After that date it may be obtained through PACER. Any Notice of Intent to Request Redaction, if required, is due no later than 5 business days from date of this filing. Redaction Request due 2/22/2012. Redacted Transcript Deadline set for 3/5/2012. Release of Transcript Restriction set for 5/1/2012. (Rodriguez, Irene) (Filed on 2/1/2012) (Entered: 02/01/2012)
- 02/01/2012 706 ORDER by Judge Lucy H. Koh granting 698 Stipulation (lhkic2, COURT STAFF) (Filed on 2/1/2012) (Entered: 02/01/2012)
- 02/02/2012 707 Administrative Motion to File Under Seal Samsung's Unopposed Motion for Issuance of a Request for Judicial Assistance and related exhibits filed by Samsung Electronics America, Inc., Samsung Electronics Co. Ltd., Samsung Telecommunications America, LLC. (Attachments: # 1 Declaration, # 2 Proposed Order, # 3 Public Redacted Motion, # 4 Declaration, # 5 Letter of Request, # 6 Proposed Order)(Maroulis, Victoria) (Filed on 2/2/2012) (Entered: 02/02/2012)
- 02/02/2012 708 CERTIFICATE OF SERVICE by Samsung Electronics America, Inc., Samsung Electronics Co. Ltd., Samsung Telecommunications America, LLC re 707 Administrative Motion to File Under Seal Samsung's Unopposed Motion for Issuance of a Request for Judicial Assistance and related exhibits (Maroulis, Victoria) (Filed on 2/2/2012) (Entered: 02/02/2012)
- 02/02/2012 709 Declaration of Cyndi Wheeler in Support of 667 Administrative Motion to File Under Seal re Samsung's Motion to Supplement Invalidity Contentions , 675 Administrative Motion to File Under Seal re Exhibit 4 to Briggs Declaration in Support of Samsung's Motion to Supplement Invalidity Contentions filed by Apple Inc.. (Attachments: # 1 Exhibit 1, # 2 Exhibit 2, # 3 Exhibit 3, # 4 Exhibit 4)(Related document(s) 667 , 675 ) (Hung, Richard) (Filed on 2/2/2012) (Entered: 02/02/2012)
- 02/03/2012 710 STIPULATION WITH PROPOSED ORDER Extending Deadline for Apple's Opposition to Samsung's Motion for Leave to Amend its Infringement Contentions filed by Apple Inc.. (Jacobs, Michael) (Filed on 2/3/2012) (Entered: 02/03/2012)
- 02/03/2012 711 ORDER by Judge Lucy H. Koh granting 710 Stipulation (lhkic2, COURT STAFF) (Filed on 2/3/2012) (Entered: 02/03/2012)
- 02/03/2012 712 STIPULATION WITH PROPOSED ORDER filed by Samsung Electronics America, Inc.(a New York corporation), Samsung Electronics Co. Ltd., Samsung Telecommunications America, LLC(a Delaware limited liability company). (Attachments: # 1 Declaration of Joby Martin In Support of Apple's Administrative Motion to File Documents Under Seal, # 2 Proposed Order Granting Apple's Motion to File Documents Under Seal)(Maroulis, Victoria) (Filed on 2/3/2012) (Entered: 02/03/2012)
- 02/03/2012 713 OPPOSITION to ( 658 First MOTION for Leave to Supplement Its Infringement Contentions ) filed by Apple Inc.. (Attachments: # 1 Hung Declaration, # 2 Exhibit A, # 3 Exhibit B, # 4 Exhibit C, # 5 Exhibit D, # 6 Exhibit E, # 7 Exhibit F, # 8 Exhibit G, # 9 Exhibit H, # 10 Exhibit I, # 11 Exhibit J, # 12 Exhibit K, # 13 Exhibit L, # 14 Exhibit M, # 15 Proposed Order)(Hung, Richard) (Filed on 2/3/2012) Modified text on 2/6/2012 (dhm, COURT STAFF). (Entered: 02/03/2012)
- 02/07/2012 714 REPLY BRIEF in Support of ( 658 First MOTION for Leave to Supplement Its Infringement Contentions ) filed by Samsung Electronics Co. Ltd.. (Attachments: # 1 Caracappa Declaration, # 2 Briggs Declaration, # 3 Exhibit A, # 4 Exhibit B)(Maroulis, Victoria) (Filed on 2/7/2012) Modified text on 2/8/2012 (dhm, COURT STAFF). (Entered: 02/07/2012)
- 02/08/2012 715 Administrative Motion to File Under Seal Apple's Administration to File Documents Under Seal filed by Apple Inc.. (Attachments: # 1 Apple Inc.'s Motion for Rule 37(B)(2) Sanctions for Samsung's Violation of Two Discovery Orders, # 2 Declaration of Minn Cheung in Support of Apple's Motion for Sanctions, # 3 Exhibit T to Chung Declaration, #



- 4 Exhibit V to Chung Declaration, # 5 Exhibit Y to Chung Declaration, # 6 Exhibit Z to Chung Declaration, # 7 Exhibit AA to Chung Declaration, # 8 Proposed Order Granting Apple's Motion for Sanctions, # 9 Proposed Order Granting Admin Motion)(Jacobs, Michael) (Filed on 2/8/2012) (Entered: 02/08/2012)
- 02/08/2012 716 CERTIFICATE OF SERVICE by Apple Inc. re 715 Administrative Motion to File Under Seal Apple's Administration to File Documents Under Seal (Jacobs, Michael) (Filed on 2/8/2012) (Entered: 02/08/2012)
- 02/08/2012 717 STIPULATION WITH PROPOSED ORDER re 660 Administrative Motion to File Under Seal Apple Inc.'s Notice of Motion and Motion for Partial Summary Judgment re Stipulation Resetting Deadlines for Briefing and Hearing filed by Samsung Electronics Co. Ltd.. (Maroulis, Victoria) (Filed on 2/8/2012) (Entered: 02/08/2012)
- 02/08/2012 719 ORDER GRANTING SAMSUNG'S UNOPPOSED MOTION FOR ISSUANCE OF A REQUEST FOR JUDICIAL ASSISTANCE, re 707 Administrative Motion to File Under Seal Samsung's Unopposed Motion for Issuance of a Request for Judicial Assistance and related exhibits filed by Samsung Electronics Co. Ltd., Samsung Telecommunications America, LLC, Samsung Electronics America, Inc. Signed by Judge Paul S. Grewal on 2/8/2012. (ofr, COURT STAFF) (Filed on 2/8/2012) (Entered: 02/09/2012)
- 02/09/2012 718 Declaration of Cyndi Wheeler in Support of 707 Administrative Motion to File Under Seal Samsung's Unopposed Motion for Issuance of a Request for Judicial Assistance and related exhibits filed by Apple Inc.. (Attachments: # 1 Exhibit A, # 2 Exhibit B, # 3 Exhibit C, # 4 Exhibit D)(Related document(s) 707 ) (Hung, Richard) (Filed on 2/9/2012) (Entered: 02/09/2012)
- 02/09/2012 720 RESPONSE (re 667 Administrative Motion to File Under Seal re Samsung's Motion to Supplement Invalidity Contentions ) APPLES OPPOSITION TO SAMSUNG'S MOTION TO SUPPLEMENT INVALIDITY CONTENTIONS filed by Apple Inc.. (Hung, Richard) (Filed on 2/9/2012) (Entered: 02/09/2012)
- 02/09/2012 721 AFFIDAVIT in Opposition re 667 Administrative Motion to File Under Seal re Samsung's Motion to Supplement Invalidity Contentions DECLARATION OF RICHARD S.J. HUNG IN SUPPORT OF APPLES OPPOSITION TO SAMSUNG'S MOTION TO SUPPLEMENT INVALIDITY CONTENTIONS filed by Apple Inc.. (Attachments: # 1 Exhibit A, # 2 Exhibit B, # 3 Exhibit C, # 4 Exhibit D, # 5 Exhibit E, # 6 Exhibit F, # 7 Exhibit G, # 8 Exhibit H, # 9 Exhibit I, # 10 Exhibit J)(Related document(s) 667 ) (Hung, Richard) (Filed on 2/9/2012) (Entered: 02/09/2012)
- 02/09/2012 722 Proposed Order re 720 Opposition/Response to Motion, [PROPOSED] ORDER DENYING SAMSUNG'S MOTION TO SUPPLEMENT ITS INVALIDITY CONTENTIONS by Apple Inc.. (Hung, Richard) (Filed on 2/9/2012) (Entered: 02/09/2012)
- 02/11/2012 723 MOTION to Compel Apples Re-Noticed Motion to Compel Timely Production of Foreign-Language Documents in Advance of Related Depositions filed by Apple Inc.. Motion Hearing set for 3/6/2012 10:00 AM in Courtroom 5, 4th Floor, San Jose before Magistrate Judge Paul Singh Grewal. Responses due by 2/27/2012. Replies due by 3/5/2012. (Jacobs, Michael) (Filed on 2/11/2012) (Entered: 02/11/2012)
- 02/12/2012 724 NOTICE of Appearance by Benjamin Laban Singer (Singer, Benjamin) (Filed on 2/12/2012) (Entered: 02/12/2012)
- 02/13/2012 725 MOTION for leave to appear in Pro Hac Vice of Paul A. Gennari ( Filing fee \$ 305, receipt number 255010HA.) Filing fee previously paid on 2/13/2012 filed by Samsung Electronics America, Inc.(a New York corporation), Samsung Electronics Co. Ltd., Samsung Telecommunications America, LLC(a Delaware limited liability company). (Attachments: # 1 Proposed Order)(Heimbold, Michael) (Filed on 2/13/2012) (Entered: 02/13/2012)
- 02/13/2012 726 ORDER by Judge Lucy H. Koh granting in part and denying in part 717 Stipulation (lhkic2, COURT STAFF) (Filed on 2/13/2012) (Entered: 02/13/2012)
- 02/13/2012 727 \*\*\* FILED IN ERROR. REFER TO DOCUMENT 729 . \*\*\* REPLY (re 701 AMENDED NOTICE OF MOTION to Amend/Correct 691 MOTION to Permit Samsung's Expert Samuel Lucente to Review Materials Designated Under the Protective Order ) filed by Apple Inc.. (Attachments: # 1 Proposed Order)(Hung, Richard) (Filed on 2/13/2012) Modified on 2/14/2012 (feriab, COURT STAFF). (Entered: 02/13/2012)
- 02/13/2012 728 \*\*\* FILED IN ERROR. REFER TO DOCUMENT 730 . \*\*\* Declaration of Marc J. Pernick in Support of 727 Reply to Opposition/Response, filed by Apple Inc.. (Attachments: # 1 Exhibit 1, # 2 Exhibit 2, # 3 Exhibit 3, # 4 Exhibit 4, # 5 Exhibit 5, # 6 Exhibit 6, # 7 Exhibit 7, # 8 Exhibit 8, # 9 Exhibit 9, # 10 Exhibit 10, # 11 Exhibit 11, # 12 Exhibit 12, # 13 Exhibit 13)(Related document(s) 727 ) (Hung, Richard) (Filed on 2/13/2012)

Modified on 2/14/2012 (feriab, COURT STAFF). (Entered: 02/13/2012)

- 02/13/2012 729 RESPONSE (re 701 AMENDED NOTICE OF MOTION to Amend/Correct 691 MOTION to Permit Samsung's Expert Samuel Lucente to Review Materials Designated Under the Protective Order ) CORRECTION OF DOCKET # 727 (correcting event from Reply to Response) filed by Apple Inc.. (Attachments: # 1 Proposed Order)(Hung, Richard) (Filed on 2/13/2012) (Entered: 02/13/2012)
- 02/13/2012 730 Declaration of Marc J. Pernick in Support of 729 Opposition/Response to Motion, CORRECTION OF DOCKET # 728 filed by Apple Inc.. (Attachments: # 1 Exhibit 1, # 2 Exhibit 2, # 3 Exhibit 3, # 4 Exhibit 4, # 5 Exhibit 5, # 6 Exhibit 6, # 7 Exhibit 7, # 8 Exhibit 8, # 9 Exhibit 9, # 10 Exhibit 10, # 11 Exhibit 11, # 12 Exhibit 12, # 13 Exhibit 13)(Related document(s) 729 ) (Hung, Richard) (Filed on 2/13/2012) (Entered: 02/13/2012)
- 02/14/2012 731 RESPONSE (re 700 MOTION to Compel Apple to Respond to Samsung's Requests for Admission ) APPLE'S OPPOSITION TO SAMSUNG'S MOTION TO COMPEL APPLE TO RESPOND TO SAMSUNG'S REQUESTS FOR ADMISSION 101-190 filed by Apple Inc.. (Bartlett, Jason) (Filed on 2/14/2012) (Entered: 02/14/2012)
- 02/14/2012 732 DECLARATION of JASON R. BARTLETT in Opposition to 700 MOTION to Compel Apple to Respond to Samsung's Requests for Admission 101-190 filed by Apple Inc.. (Attachments: # 1 Exhibit A, # 2 Exhibit B, # 3 Exhibit C)(Related document(s) 700 ) (Bartlett, Jason) (Filed on 2/14/2012) (Entered: 02/14/2012)
- 02/14/2012 733 Proposed Order re 700 MOTION to Compel Apple to Respond to Samsung's Requests for Admission [PROPOSED] ORDER DENYING SAMSUNG'S MOTION TO COMPEL APPLE TO RESPOND TO SAMSUNG'S REQUESTS FOR ADMISSION 101-190 by Apple Inc.. (Bartlett, Jason) (Filed on 2/14/2012) (Entered: 02/14/2012)
- 02/15/2012 734 NOTICE of Appearance by Christine E. Duh (Duh, Christine) (Filed on 2/15/2012) (Entered: 02/15/2012)
- 02/16/2012 735 RESPONSE (re 702 MOTION to Compel Apple's Re-Noticed Motion to Compel Timely Production of Foreign-Language and Other Documents in Advance of Related Depositions ) filed by Samsung Electronics America, Inc.(a New York corporation), Samsung Electronics Co. Ltd., Samsung Telecommunications America, LLC(a Delaware limited liability company). (Attachments: # 1 Declaration of Rachel Herrick Kassabian In Support of Samsung's Opposition to Apple's Motion to Compel, # 2 Declaration of Joby Martin In Support of Samsung's Opposition to Apple's Motion to Compel, # 3 Declaration of Alexander B. Binder In Support of Samsung's Opposition to Apple's Motion to Compel) (Maroulis, Victoria) (Filed on 2/16/2012) (Entered: 02/16/2012)
- 02/16/2012 736 Administrative Motion to File Under Seal filed by Apple Inc.. (Attachments: # 1 Proposed Order granting administrative to file under seal, # 2 [Public] APPLE INC.S MOTION TO COMPEL DEPOSITIONS OF 14 OF SAMSUNG'S PURPORTED APEX WITNESSES, # 3 Declaration [Public] Mazza Declaration in Support of APPLE INC.S MOTION TO COMPEL DEPOSITIONS OF 14 OF SAMSUNG'S PURPORTED APEX WITNESSES, # 4 Exhibit 15, # 5 Exhibit 16, # 6 Proposed Order granting motion to compel)(Jacobs, Michael) (Filed on 2/16/2012) (Entered: 02/16/2012)
- 02/16/2012 737 Administrative Motion to File Under Seal filed by Apple Inc.. (Attachments: # 1 Declaration Cyndi Wheeler Declaration, # 2 Declaration S. Calvin Walden Declaration, # 3 Exhibit 1, # 4 Exhibit 11, # 5 Exhibit 12, # 6 Exhibit 13, # 7 Exhibit 14, # 8 Exhibit 15, # 9 Exhibit 16, # 10 Exhibit 17, # 11 Exhibit 18, # 12 Exhibit 19, # 13 Exhibit 20, # 14 Proposed Order)(Jacobs, Michael) (Filed on 2/16/2012) (Entered: 02/16/2012)
- 02/16/2012 738 MOTION to Shorten Time filed by Apple Inc.. (Attachments: # 1 Mazza Declaration in Support of Motion to Shorten Time, # 2 Proposed Order)(Jacobs, Michael) (Filed on 2/16/2012) (Entered: 02/16/2012)
- 02/16/2012 739 Declaration of Melissa N. Chan in Support of 715 Administrative Motion to File Under Seal Apple's Administration to File Documents Under Seal filed by Samsung Electronics America, Inc., Samsung Electronics Co. Ltd., Samsung Telecommunications America, LLC. (Related document(s) 715 ) (Maroulis, Victoria) (Filed on 2/16/2012) (Entered: 02/16/2012)
- 02/16/2012 740 OPPOSITION to ( 738 MOTION to Shorten Time ) filed by Samsung Electronics America, Inc., Samsung Electronics Co. Ltd., Samsung Telecommunications America, LLC. (Attachments: # 1 Declaration, # 2 Proposed Order)(Maroulis, Victoria) (Filed on 2/16/2012) Modified text on 2/17/2012 (dhm, COURT STAFF). (Entered: 02/16/2012)
- 02/16/2012 741 MOTION for Attorney Fees AND COSTS IN CONNECTION WITH MOTION TO COMPEL DEPOSITIONS OF 14 OF SAMSUNG'S PURPORTED "APEX" WITNESSES filed by Apple Inc..

- Motion Hearing set for 3/27/2012 10:00 AM in Courtroom 5, 4th Floor, San Jose before Magistrate Judge Paul Singh Grewal. Responses due by 3/1/2012. Replies due by 3/8/2012. (Attachments: # 1 Proposed Order)(Jacobs, Michael) (Filed on 2/16/2012) (Entered: 02/16/2012)
- 02/17/2012 742 REPLY (re 738 MOTION to Shorten Time ) filed by Apple Inc.. (Attachments: # 1 Declaration of Mia Mazza in Support of Apple's Reply in Support of Motion to Shorten Time re "Apex" Witnesses, # 2 Exhibit A)(Jacobs, Michael) (Filed on 2/17/2012) (Entered: 02/17/2012)
- 02/17/2012 743 Minute Entry: Telephone Conference as to Plaintiff's Motion to Shorten Time for Briefing & Hearing on Plaintiff's Motion to Compel (In Re: Docket No. 738 ) held. Court to issue order as to motion to shorten time. (Date Filed: 2/17/2012). (Court Reporter: Irene Rodriguez.) (ofr, COURT STAFF) (Date Filed: 2/17/2012) (Entered: 02/17/2012)
- 02/21/2012 744 CERTIFICATE OF SERVICE by Apple Inc. re 736 Administrative Motion to File Under Seal APPLE INC.'S MOTION TO COMPEL DEPOSITIONS OF 14 OF SAMSUNG'S PURPORTED "APEX" WITNESSES (Jacobs, Michael) (Filed on 2/21/2012) (Entered: 02/21/2012)
- 02/21/2012 745 ORDER by Judge Paul S. Grewal denying 738 Motion to Shorten Time (psglc2, COURT STAFF) (Filed on 2/21/2012) (Entered: 02/21/2012)
- 02/21/2012 746 Renotice motion hearing re 736 Administrative Motion to File Under Seal Apple Inc.'s Re-Noticed Motion to Compel Depositions of 14 of Samsung's Purported "Apex" Witnesses filed by Apple Inc.. Motion Hearing set for 3/27/2012 10:00 AM in Courtroom 5, 4th Floor, San Jose before Magistrate Judge Paul Singh Grewal. (Related document(s) 736 ) (Jacobs, Michael) (Filed on 2/21/2012) (Entered: 02/21/2012)
- 02/21/2012 747 MOTION for leave to appear in Pro Hac Vice for attorney Edward H. Rice ( Filing fee \$ 305, receipt number 0971-6603129.) filed by Samsung Electronics America, Inc., Samsung Electronics Co. Ltd., Samsung Telecommunications America, LLC. (Singer, Benjamin) (Filed on 2/21/2012) Modified text to add attorney's name on 2/22/2012 (srm, COURT STAFF). (Entered: 02/21/2012)
- 02/21/2012 748 MOTION for leave to appear in Pro Hac Vice for attorney Marina N. Saito ( Filing fee \$ 305, receipt number 0971-6603180.) filed by Samsung Electronics America, Inc., Samsung Electronics Co. Ltd., Samsung Telecommunications America, LLC. (Singer, Benjamin) (Filed on 2/21/2012) Modified text to add attorney's name on 2/22/2012 (srm, COURT STAFF). (Entered: 02/21/2012)
- 02/21/2012 749 REPLY (re 700 MOTION to Compel Apple to Respond to Samsung's Requests for Admission ) filed by Samsung Electronics America, Inc., Samsung Electronics Co. Ltd., Samsung Telecommunications America, LLC. (Attachments: # 1 Declaration, # 2 Exhibit A, # 3 Exhibit B, # 4 Exhibit C)(Maroulis, Victoria) (Filed on 2/21/2012) (Entered: 02/21/2012)
- 02/22/2012 750 ORDER by Judge Lucy H. Koh granting 725 Motion for Pro Hac Vice (lhkic2, COURT STAFF) (Filed on 2/22/2012) (Entered: 02/22/2012)
- 02/22/2012 751 STIPULATION WITH PROPOSED ORDER re 715 Administrative Motion to File Under Seal Apple's Administration to File Documents Under Seal STIPULATION AND PROPOSED ORDER EXTENDING BRIEFING SCHEDULE FOR APPLE'S MOTION FOR RULE 37(B) SANCTIONS filed by Samsung Electronics America, Inc., Samsung Electronics Co. Ltd., Samsung Telecommunications America, LLC. (Maroulis, Victoria) (Filed on 2/22/2012) (Entered: 02/22/2012)
- 02/23/2012 752 \*\*\* FILED IN ERROR WITH CONFIDENTIAL INFORMATION. DOCUMENT LOCKED. DOCUMENT TO BE REFILED LATER. \*\*\* Administrative Motion to File Under Seal filed by Samsung Electronics America, Inc., Samsung Electronics Co. Ltd., Samsung Telecommunications America, LLC. (Attachments: # 1 Proposed Order to File Documents Under Seal, # 2 Declaration of Hankil Kang In Support of Motion to Seal, # 3 Exhibit 1 to Kang Declaration, # 4 Exhibit 2 to Kang Declaration, # 5 Exhibit 3 to Kang Declaration, # 6 Exhibit 4 to Kang Declaration, # 7 Exhibit 5 to Kang Declaration, # 8 Exhibit 6 to Kang Declaration, # 9 Exhibit 7 to Kang Declaration, # 10 Exhibit 8 to Kang Declaration, # 11 Exhibit 9 to Kang Declaration, # 12 Exhibit 10 to Kang Declaration, # 13 Exhibit 11 to Kang Declaration, # 14 Exhibit 12 to Kang Declaration, # 15 Declaration of Rachel Herrick Kassabian In Support of Samsung's Motion for Protective Order, # 16 Exhibit A to Kassabian Declaration, # 17 Exhibit B to Kassabian Declaration, # 18 Exhibit C to Kassabian Declaration, # 19 Exhibit D to Kassabian Declaration, # 20 Exhibit E to Kassabian Declaration, # 21 Exhibit F to Kassabian Declaration, # 22 Exhibit G to Kassabian Declaration, # 23 Exhibit H to Kassabian Declaration, # 24 Exhibit I to Kassabian Declaration, # 25 Exhibit J to Kassabian Declaration, # 26 Exhibit K to Kassabian Declaration, # 27 Exhibit L to Kassabian Declaration, # 28 Exhibit M to

- Kassabian Declaration, # 29 Exhibit N to Kassabian Declaration, # 30 Proposed Order Granting Samsung's Motion for Protective Order)(Maroulis, Victoria) (Filed on 2/23/2012) Modified on 2/23/2012 (feriab, COURT STAFF). (Entered: 02/23/2012)
- 02/23/2012 753 STIPULATION AND ORDER EXTENDING BRIEFING SCHEDULE FOR APPLES MOTION FOR RULE 37(b) SANCTIONS by Judge Paul S. Grewal, granting 751 Stipulation (ofr, COURT STAFF) (Filed on 2/23/2012) (Entered: 02/23/2012)
- 02/23/2012 754 Administrative Motion to File Under Seal filed by Samsung Electronics America, Inc., Samsung Electronics Co. Ltd., Samsung Telecommunications America, LLC. (Attachments: # 1 Declaration of Hankil Kang In Support of Samsung's Administrative Motion to File Documents Under Seal, # 2 Exhibit 1 to Kang Decl.: [REDACTED] Samsung's Motion for a Protective Order, # 3 Exhibit 2 to Kang Decl.: [REDACTED] Samuel Lee Declaration ISO Samsung's Motion for Protective Order, # 4 Exhibit 3 to Kang Decl.: [REDACTED] Gee Sung Choi Declaration ISO Samsung's Motion for Protective Order, # 5 Exhibit 4 to Kang Decl.: [REDACTED] Jong Kyun Shin Declaration ISO Samsung's Motion for Protective Order, # 6 Exhibit 5 to Kang Decl.: [REDACTED] WonPyo Hong Declaration ISO Samsung's Motion for Protective Order, # 7 Exhibit 6 to Kang Decl.: [REDACTED] Heonbae Kim Declaration ISO Samsung's Motion for Protective Order, # 8 Exhibit 7 to Kang Decl.: [REDACTED] Seunghwan Cho Declaration ISO Samsung's Motion for Protective Order, # 9 Exhibit 8 to Kang Decl.: [REDACTED] Dong Jin Koh Declaration ISO Samsung's Motion for Protective Order, # 10 Exhibit 9 to Kang Decl.: [REDACTED] Dale Sohn Declaration ISO Samsung's Motion for Protective Order, # 11 Exhibit 10 to Kang Decl.: [REDACTED] Joseph Cheong Declaration ISO Samsung's Motion for Protective Order, # 12 Declaration of Rachel Herrick Kassabian ISO Samsung's Motion for Protective Order, # 13 Exhibit A to Kassabian Declaration, # 14 Exhibit B to Kassabian Declaration, # 15 Exhibit C to Kassabian Declaration, # 16 Exhibit D to Kassabian Declaration, # 17 Exhibit E to Kassabian Declaration, # 18 Exhibit F to Kassabian Declaration, # 19 Exhibit G to Kassabian Declaration, # 20 Exhibit H to Kassabian Declaration, # 21 Exhibit I to Kassabian Declaration, # 22 Exhibit J to Kassabian Declaration, # 23 Exhibit K to Kassabian Declaration, # 24 Exhibit L to Kassabian Declaration, # 25 Exhibit M to Kassabian Declaration, # 26 Exhibit N to Kassabian Declaration, # 27 Proposed Order Granting Samsung's Motion to File Documents Under Seal, # 28 Proposed Order Granting Samsung's Motion for a Protective Order)(Maroulis, Victoria) (Filed on 2/23/2012) (Entered: 02/23/2012)
- 02/24/2012 755 \*\*\* FILED IN ERROR. REFER TO DOCUMENT 756 . \*\*\* REPLY (re 723 MOTION to Compel Apples Re-Noticed Motion to Compel Timely Production of Foreign-Language Documents in Advance of Related Depositions , 682 MOTION to Compel Apple's Motion to Compel Timely Production of Foreign-Language and Other Documents in Advance of Related Depositions ) filed byApple Inc.. (Attachments: # 1 Declaration Mazza Declaration in Support of Motion to Compel Timely Foreign Production, # 2 Exhibit A, # 3 Proposed Order)(Jacobs, Michael) (Filed on 2/24/2012) Modified on 2/24/2012 (feriab, COURT STAFF). (Entered: 02/24/2012)
- 02/24/2012 756 REPLY (re 723 MOTION to Compel Apples Re-Noticed Motion to Compel Timely Production of Foreign-Language Documents in Advance of Related Depositions , 682 MOTION to Compel Apple's Motion to Compel Timely Production of Foreign-Language and Other Documents in Advance of Related Depositions ) filed byApple Inc.. (Attachments: # 1 Declaration Mazza Reply Declaration in Support of Apple's Motion to Compel Timely Production of Foreign-Language and Other Documents in Advance of Related Depositions, # 2 Exhibit A, # 3 Proposed Order)(Jacobs, Michael) (Filed on 2/24/2012) (Entered: 02/24/2012)
- 02/24/2012 757 NOTICE of Appearance by James E. Hopenfeld (Hopenfeld, James) (Filed on 2/24/2012) (Entered: 02/24/2012)
- 02/25/2012 758 Administrative Motion to File Under Seal filed by Samsung Electronics America, Inc., Samsung Electronics Co. Ltd., Samsung Telecommunications America, LLC. (Attachments: # 1 Declaration of Melissa Chan In Support of Samsung's Administrative Motion to File Under Seal, # 2 Proposed Order Granting Samsung's Motion to Seal, # 3 REDACTED Samsung's Opposition to Apple's Motion for Sanctions, # 4 Declaration of Sara Jenkins In Support of Samsung's Opposition to Apple's Motion for Sanctions - REDACTED, # 5 Exhibit A to Jenkins Declaration, # 6 Exhibit B to Jenkins Declaration, # 7 Exhibit C to Jenkins Declaration, # 8 Exhibit D to Jenkins Declaration, # 9 Exhibit E to Jenkins Declaration, # 10 Exhibit F to Jenkins Declaration, # 11 Exhibit G to Jenkins Declaration, # 12 Exhibit H to Jenkins Declaration, # 13 Exhibit I to Jenkins Declaration, # 14 Exhibit J to Jenkins Declaration, # 15 Exhibit K to Jenkins Declaration, # 16 Exhibit L to Jenkins Declaration, # 17 Exhibit M to Jenkins Declaration, # 18 Exhibit N to Jenkins Declaration, # 19 Exhibit O to Jenkins Declaration, # 20 Certificate/Proof of Service)

- (Maroulis, Victoria) (Filed on 2/25/2012) (Entered: 02/25/2012)
- 02/28/2012 759 Administrative Motion to File Under Seal filed by Apple Inc.. (Attachments: # 1 Proposed Order, # 2 Redacted Public Version of Apple's Rule 37(b)(2) Motion Re Samsung's Violation of January 27, 2012 Damages Discovery Order, # 3 Proposed Order, # 4 Public Redacted Version of Declaration of Erik J. Olson, # 5 Public Redacted Version of the Declaration of Eric R. Roberts)(Jacobs, Michael) (Filed on 2/28/2012) (Entered: 02/28/2012)
- 02/29/2012 760 STIPULATION WITH PROPOSED ORDER re Briefing Schedule for Apple's Apex Motion and Motion for Fees filed by Samsung Electronics America, Inc.(a New York corporation), Samsung Electronics Co. Ltd., Samsung Telecommunications America, LLC(a Delaware limited liability company). (Attachments: # 1 Declaration of Michael L. Fazio)(Maroulis, Victoria) (Filed on 2/29/2012) (Entered: 02/29/2012)
- 02/29/2012 761 MOTION to Withdraw 701 AMENDED NOTICE OF MOTION to Amend/Correct 691 MOTION to Permit Samsung's Expert Samuel Lucente to Review Materials Designated Under the Protective Order filed by Samsung Electronics Co. Ltd.. Responses due by 3/14/2012. Replies due by 3/21/2012. (Attachments: # 1 Proposed Order)(Maroulis, Victoria) (Filed on 2/29/2012) (Entered: 02/29/2012)
- 03/01/2012 762 STIPULATION AND ORDER RE: BRIEFING SCHEDULE FOR APPLE'S APEX MOTION AND APPLE'S MOTION FOR ASSOCIATED FEES by Judge Paul S. Grewal, granting 760 Stipulation (ofr, COURT STAFF) (Filed on 3/1/2012) (Entered: 03/01/2012)
- 03/01/2012 763 ORDER by Judge Lucy H. Koh granting 519 Administrative Motion to File Under Seal; granting 530 Motion for Reconsideration ; granting 547 Motion for Reconsideration (lhkic2, COURT STAFF) (Filed on 3/1/2012) (Entered: 03/01/2012)
- 03/01/2012 764 ORDER by Judge Lucy H. Koh granting in part and denying in part 660 Administrative Motion to File Under Seal; granting 712 Stipulation (lhkic2, COURT STAFF) (Filed on 3/1/2012) (Entered: 03/01/2012)
- 03/01/2012 765 ORDER by Judge Lucy H. Koh granting in part and denying in part 548 Administrative Motion to File Under Seal (lhkic2, COURT STAFF) (Filed on 3/1/2012) (Entered: 03/01/2012)
- 03/04/2012 766 MOTION for Leave to File Administrative Request for Leave to File Supplemental Mazza Declaration in Support of Apple's Motion to Compel Timely Production of Foreign-Language and Other Documents in Advance of Related Depositions filed by Apple Inc.. (Attachments: # 1 Supplement Supplemental Declaration of Mia Mazza in Support of Apple's Motion to Compel Timely Production of Foreign-Language and Other Documents in Advance of Related Depositions, # 2 Exhibit A-1 to the Supplemental Mazza Declaration, # 3 Proposed Order Proposed Order)(Hung, Richard) (Filed on 3/4/2012) (Entered: 03/04/2012)
- 03/05/2012 767 Declaration of Cyndi Wheeler in Support of 758 Administrative Motion to File Under Seal filed by Apple Inc.. (Attachments: # 1 Exhibit 1, # 2 Exhibit 2)(Related document(s) 758 ) (Hung, Richard) (Filed on 3/5/2012) (Entered: 03/05/2012)
- 03/05/2012 768 ORDER GRANTING ADMINISTRATIVE REQUEST FOR LEAVE TO FILE SUPPLEMENTAL DECLARATION OF MIA MAZZA by Judge Paul S. Grewal, granting 766 Motion for Leave to File (ofr, COURT STAFF) (Filed on 3/5/2012) (Entered: 03/05/2012)
- 03/05/2012 769 Administrative Motion to File Under Seal filed by Apple Inc.(a California corporation). (Attachments: # 1 Proposed Order, # 2 [Redacted Public Version] Apple Inc.'s Reply in Support of Motion for Rule 37(b)(2) Sanctions, # 3 [Redacted Public Version] Reply Declaration of Minn Chung in Support of Apple's Motion for Rule 37(b)(2) Sanctions, # 4 [Redacted Public Version] Erik J. Olson Reply Declaration in Support of Apple's Motion for Rule 37(b)(2) Sanctions)(Jacobs, Michael) (Filed on 3/5/2012) (Entered: 03/05/2012)
- 03/05/2012 770 Declaration of JASON R. BARTLETT in Support of 715 Administrative Motion to File Under Seal Apple's Administration to File Documents Under Seal Reply Declaration of Jason R. Bartlett in Support of Apple's Motion for Rule 37(b)(2) Sanctions filed by Apple Inc.(a California corporation). (Attachments: # 1 Exhibit A)(Related document(s) 715 ) (Jacobs, Michael) (Filed on 3/5/2012) (Entered: 03/05/2012)
- 03/05/2012 771 Supplemental Declaration of Mia Mazza in Support of 756 Apples Motion To Compel Timely Production Of Foreign-Language And Other Documents In Advance Of Related Depositions filed by Apple Inc.. (Attachments: # 1 Exhibit A-1)(Related document(s) 756 ) (Hung, Richard) (Filed on 3/5/2012) Modified text on 3/6/2012 (dhrn, COURT STAFF). (Entered: 03/05/2012)
- 03/05/2012 772 OPPOSITION to ( 741 MOTION for Attorney Fees AND COSTS IN CONNECTION WITH

- MOTION TO COMPEL DEPOSITIONS OF 14 OF SAMSUNG'S PURPORTED "APEX" WITNESSES ) filed by Samsung Electronics America, Inc., Samsung Electronics Co. Ltd., Samsung Telecommunications America, LLC. (Attachments: # 1 Proposed Order) (Maroulis, Victoria) (Filed on 3/5/2012) Modified text on 3/6/2012 (dhm, COURT STAFF). (Entered: 03/05/2012)
- 03/05/2012 779 APPLICATION of Timothy D. Syrett for Admission Pro Hac Vice ( Filing fee \$ 305, receipt number 54611011435) Filing fee previously paid on 3/5/2012 filed by Apple Inc.(a California corporation). (dhm, COURT STAFF) (Filed on 3/5/2012) (Entered: 03/06/2012)
- 03/05/2012 780 Proposed Order re 779 APPLICATION of Timothy D. Syrett for Admission Pro Hac Vice ( Filing fee \$ 305, receipt number 54611011435) Filing fee previously paid on 3/5/2012 by Apple Inc.(a California corporation). (dhm, COURT STAFF) (Filed on 3/5/2012) (Entered: 03/06/2012)
- 03/06/2012 773 RESPONSE (re 736 Administrative Motion to File Under Seal ) Opposition to Apple's Motion to Compel filed by Samsung Electronics America, Inc.(a New York corporation), Samsung Electronics Co. Ltd., Samsung Telecommunications America, LLC(a Delaware limited liability company). (Attachments: # 1 Proposed Order Granting Administrative Motion to File Documents Under Seal, # 2 Declaration of Hankil Kang in Support of Samsung's Motion to File Documents Under Seal, # 3 Exhibit Samsung's Redacted Opposition to Apple's Motion to Compel, # 4 Declaration of Joby Martin In Support of Samsung's Opposition to Apple's Motion to Compel, # 5 Exhibit A to Declaration of Joby Martin, # 6 Proposed Order Denying Apple's Motion to Compel)(Maroulis, Victoria) (Filed on 3/6/2012) (Entered: 03/06/2012)
- 03/06/2012 774 MOTION Leave to File Sur-Reply filed by Samsung Electronics America, Inc.(a New York corporation), Samsung Electronics Co. Ltd., Samsung Telecommunications America, LLC (a Delaware limited liability company). Motion Hearing set for 3/6/2012 10:00 AM before Magistrate Judge Paul Singh Grewal. Responses due by 3/20/2012. (Attachments: # 1 Proposed Order Granting Leave to File Sur-Reply, # 2 Supplement Sur-Reply In Support of Samsung's Opposition to Apple's Motion to Compel, # 3 Declaration of Joby Martin In Support of Samsung's Sur-Reply, # 4 Declaration of Melissa Dalziel In Support of Samsung's Sur-Reply)(Maroulis, Victoria) (Filed on 3/6/2012) (Entered: 03/06/2012)
- 03/06/2012 775 ORDER GRANTING SAMSUNG'S ADMINISTRATIVE REQUEST TO FILE SUR-REPLY IN SUPPORT OF ITS OPPOSITION TO APPLE'S MOTION TO COMPEL by Judge Paul S. Grewal, granting 774 Motion (ofr, COURT STAFF) (Filed on 3/6/2012) (Entered: 03/06/2012)
- 03/06/2012 776 Minute Entry: Motion Hearing held on 3/6/2012 before Magistrate Judge Paul S. Grewal (Date Filed: 3/6/2012) re 723 MOTION to Compel Apples Re-Noticed Motion to Compel Timely Production of Foreign-Language Documents in Advance of Related Depositions filed by Apple Inc., 700 MOTION to Compel Apple to Respond to Samsung's Requests for Admission filed by Samsung Electronics Co. Ltd., Samsung Telecommunications America, LLC, Samsung Electronics America, Inc. The Court takes matters under submission; written order after hearing to be issued. (Court Reporter: Summer Fisher.) (ofr, COURT STAFF) (Date Filed: 3/6/2012) (Entered: 03/06/2012)
- 03/06/2012 777 Proposed Order re 747 MOTION for leave to appear in Pro Hac Vice ( Filing fee \$ 305, receipt number 0971-6603129.) by Samsung Electronics America, Inc., Samsung Electronics Co. Ltd., Samsung Telecommunications America, LLC. (Singer, Benjamin) (Filed on 3/6/2012) (Entered: 03/06/2012)
- 03/06/2012 778 Proposed Order re 748 MOTION for leave to appear in Pro Hac Vice ( Filing fee \$ 305, receipt number 0971-6603180.) by Samsung Electronics America, Inc., Samsung Electronics Co. Ltd., Samsung Telecommunications America, LLC. (Singer, Benjamin) (Filed on 3/6/2012) (Entered: 03/06/2012)
- 03/07/2012 781 Administrative Motion to File Under Seal filed by Samsung Electronics America, Inc., Samsung Electronics Co. Ltd., Samsung Telecommunications America, LLC. (Attachments: # 1 Proposed Order Granting Samsung's Motion to File Documents Under Seal, # 2 Exhibit 1 to Motion to Seal: Redacted Samsung Motion to Compel Production, # 3 Exhibit 2 to Motion to Seal: Redacted Diane Hutnyan Declaration ISO Samsung's Motion to Compel, # 4 Exhibit A to Hutnyan Declaration, # 5 Exhibit B to Hutnyan Declaration, # 6 Exhibit C to Hutnyan Declaration, # 7 Exhibit D to Hutnyan Declaration, # 8 Exhibit E to Hutnyan Declaration, # 9 Exhibit F to Hutnyan Declaration, # 10 Proposed Order Granting Samsung's Motion to Compel Efforts to Obtain Documents Related to Design Patents)(Maroulis, Victoria) (Filed on 3/7/2012) (Entered: 03/07/2012)
- 03/07/2012 782 Administrative Motion to File Under Seal re Samsung's Motion Compel Production Materials From Related Proceedings and to Enforce 12/22/11 Court Order filed by Samsung Electronics America, Inc., Samsung Electronics Co. Ltd., Samsung

Telecommunications America, LLC. (Attachments: # 1 Proposed Order Granting Samsung's Motion to Seal, # 2 Exhibit 1 to Motion to Seal: Redacted Motion to Compel re Related Proceedings, # 3 Exhibit 2 to Motion to Seal: Redacted Diane Hutnyan Declaration ISO Motion to Compel re Related Proceedings, # 4 Exhibit A to Hutnyan Declaration, # 5 Exhibit B to Hutnyan Declaration, # 6 Exhibit C to Hutnyan Declaration, # 7 Exhibit D to Hutnyan Declaration, # 8 Exhibit E to Hutnyan Declaration, # 9 Exhibit F to Hutnyan Declaration, # 10 Exhibit G to Hutnyan Declaration, # 11 Exhibit H to Hutnyan Declaration, # 12 Exhibit I to Hutnyan Declaration, # 13 Exhibit J to Hutnyan Declaration, # 14 Exhibit K to Hutnyan Declaration, # 15 Exhibit L to Hutnyan Declaration, # 16 Exhibit M to Hutnyan Declaration, # 17 Exhibit N to Hutnyan Declaration, # 18 Proposed Order Granting Samsung's Motion to Compel Production Materials From Related Proceedings and to Enforce 12/22/11 Court Order)(Maroulis, Victoria) (Filed on 3/7/2012) (Entered: 03/07/2012)

- 03/07/2012 783 ORDER by Judge Lucy H. Koh granting 779 Motion for Pro Hac Vice (lhkcl2, COURT STAFF) (Filed on 3/7/2012) (Entered: 03/07/2012)
- 03/07/2012 784 ORDER by Judge Lucy H. Koh granting 747 Motion for Pro Hac Vice (lhkcl2, COURT STAFF) (Filed on 3/7/2012) (Entered: 03/07/2012)
- 03/07/2012 785 ORDER by Judge Lucy H. Koh granting 748 Motion for Pro Hac Vice (lhkcl2, COURT STAFF) (Filed on 3/7/2012) (Entered: 03/07/2012)
- 03/07/2012 786 NOTICE by Apple Inc. re 736 Administrative Motion to File Under Seal Apple's Notice of Lodgment of Corrected Exhibit 8 to the Declaration of Mia Mazza in Support of Apple's Motion to Compel Depositions of 14 of Samsung's Purported "Apex" Witnesses (Hung, Richard) (Filed on 3/7/2012) (Entered: 03/07/2012)
- 03/07/2012 787 CERTIFICATE OF SERVICE by Apple Inc. re 786 Notice (Other), Apple's Corrected Exhibit 8 to the Declaration of Mia Mazza in Support of Apple's Motion to Compel Depositions of 14 of Samsung's Purported "Apex" Witnesses (Hung, Richard) (Filed on 3/7/2012) (Entered: 03/07/2012)
- 03/08/2012 788 ORDER by Judge Paul S. Grewal granting in part and denying in part 682 , 702 , 723 Motion to Compel (psglc2, COURT STAFF) (Filed on 3/8/2012) (Entered: 03/08/2012)
- 03/08/2012 789 STIPULATION WITH PROPOSED ORDER STIPULATION AND [PROPOSED ORDER] REGARDING SCHEDULE FOR BRIEFING APEX-RELATED MOTION TO COMPEL AND MOTION FOR PROTECTIVE ORDER filed by Apple Inc.(a California corporation). (Jacobs, Michael) (Filed on 3/8/2012) (Entered: 03/08/2012)
- 03/08/2012 790 Declaration of MICHAEL A. JACOBS in Support of 789 STIPULATION WITH PROPOSED ORDER STIPULATION AND [PROPOSED ORDER] REGARDING SCHEDULE FOR BRIEFING APEX-RELATED MOTION TO COMPEL AND MOTION FOR PROTECTIVE ORDER filed by Apple Inc.(a California corporation). (Related document(s) 789 ) (Jacobs, Michael) (Filed on 3/8/2012) (Entered: 03/08/2012)
- 03/08/2012 791 Declaration of Melissa N. Chan in Support of 737 Administrative Motion to File Under Seal , 736 Administrative Motion to File Under Seal filed by Samsung Electronics America, Inc., Samsung Electronics Co. Ltd., Samsung Telecommunications America, LLC. (Related document(s) 737 , 736 ) (Maroulis, Victoria) (Filed on 3/8/2012) (Entered: 03/08/2012)
- 03/09/2012 792 ORDER by Judge Paul S. Grewal granting 789 Stipulation as modified by the Court (psglc2, COURT STAFF) (Filed on 3/9/2012) (Entered: 03/09/2012)
- 03/09/2012 793 Transcript of Proceedings held on 02/17/2012, before Judge Grewal. Court Reporter/Transcriber Irene Rodriguez, Telephone number (408)947-8160. Per General Order No. 59 and Judicial Conference policy, this transcript may be viewed only at the Clerks Office public terminal or may be purchased through the Court Reporter/Transcriber until the deadline for the Release of Transcript Restriction. After that date it may be obtained through PACER. Any Notice of Intent to Request Redaction, if required, is due no later than 5 business days from date of this filing. Redaction Request due 3/30/2012. Redacted Transcript Deadline set for 4/9/2012. Release of Transcript Restriction set for 6/7/2012. (Rodriguez, Irene) (Filed on 3/9/2012) (Entered: 03/09/2012)
- 03/09/2012 794 UNOPPOSED MOTION to Move the Date of the April 5 Case Management Conference and Hearing filed by Samsung Electronics America, Inc., Samsung Electronics Co. Ltd., Samsung Telecommunications America, LLC. Responses due by 3/23/2012. Replies due by 3/30/2012. (Attachments: # 1 Proposed Order)(Maroulis, Victoria) (Filed on 3/9/2012) Modified text on 3/12/2012 (dhm, COURT STAFF). (Entered: 03/09/2012)
- 03/09/2012 795 MOTION for Sanctions Apple's Rule 37(b)(2) Motion Based on Samsung's Violation of the Court's December 22, 2011 Order Regarding Source Code filed by Apple Inc.(a California

corporation). Motion Hearing set for 4/24/2012 10:00 AM in Courtroom 5, 4th Floor, San Jose before Magistrate Judge Paul Singh Grewal. Responses due by 3/23/2012. Replies due by 3/30/2012. (Attachments: # 1 Proposed Order)(Jacobs, Michael) (Filed on 3/9/2012) (Entered: 03/09/2012)

- 03/09/2012 796 Declaration of Marc J. Pernick in Support of 795 MOTION for Sanctions Apple's Rule 37(b) (2) Motion Based on Samsung's Violation of the Court's December 22, 2011 Order Regarding Source Code filed by Apple Inc.(a California corporation). (Attachments: # 1 Exhibit A, # 2 Exhibit B, # 3 Exhibit C, # 4 Exhibit D, # 5 Exhibit E, # 6 Exhibit F, # 7 Exhibit G)(Related document(s) 795 ) (Jacobs, Michael) (Filed on 3/9/2012) (Entered: 03/09/2012)
- 03/09/2012 797 ORDER by Judge Lucy H. Koh granting in part and denying in part 667 Administrative Motion to File Under Seal; granting 674 Motion to Remove Incorrectly Filed Document; granting 675 Administrative Motion to File Under Seal (lhkic2, COURT STAFF) (Filed on 3/9/2012) (Entered: 03/09/2012)
- 03/12/2012 798 STIPULATION WITH PROPOSED ORDER re non-party Walmart filed by Samsung Electronics America, Inc., Samsung Electronics Co. Ltd., Samsung Telecommunications America, LLC. (Maroulis, Victoria) (Filed on 3/12/2012) (Entered: 03/12/2012)
- 03/12/2012 799 Administrative Motion to File Under Seal filed by Apple Inc.(a California corporation). (Attachments: # 1 Proposed Order, # 2 [Redacted Public Version] Apple's Combined Reply, # 3 Proposed Order, # 4 [Redacted Public Version] Declaration of Mia Mazza in Support of Apple's Combined Reply, # 5 Exhibit 1 to [Redacted Public Version] of Declaration of Mia Mazza, # 6 Exhibit 2 to [Redacted Public Version] of Declaration of Mia Mazza, # 7 Exhibit 3 to [Redacted Public Version] of Declaration of Mia Mazza, # 8 Exhibit 4 to [Redacted Public Version] of Declaration of Mia Mazza, # 9 Exhibit 33 to [Redacted Public Version] of Declaration of Mia Mazza)(Jacobs, Michael) (Filed on 3/12/2012) (Entered: 03/12/2012)
- 03/12/2012 800 MOTION Administrative Motion for Relief from Lead Counsel Meet and Confer Requirement or Extension of Deadline to File Motions filed by Samsung Electronics America, Inc., Samsung Electronics Co. Ltd., Samsung Telecommunications America, LLC. Responses due by 3/26/2012. Replies due by 4/2/2012. (Attachments: # 1 Declaration, # 2 Exhibit 1, # 3 Exhibit 2, # 4 Exhibit 3, # 5 Exhibit 4, # 6 Exhibit 5, # 7 Exhibit 6, # 8 Exhibit 7, # 9 Proposed Order)(Maroulis, Victoria) (Filed on 3/12/2012) (Entered: 03/12/2012)
- 03/12/2012 804 ORDER GRANTING APPLE INC.'S MOTION TO REMOVE INCORRECTLY FILED DOCUMENTS by Judge Paul S. Grewal, granting 612 Motion to Remove Incorrectly Filed Document. The Court hereby grants Apple Inc.'s Motion to Remove Incorrectly Filed Documents: Docket No. 600 . (ofr, COURT STAFF) (Filed on 3/12/2012) (Entered: 03/13/2012)
- 03/13/2012 801 Administrative Motion to File Under Seal filed by Samsung Electronics America, Inc.(a New York corporation), Samsung Electronics Co. Ltd.(a Korean corporation), Samsung Telecommunications America, LLC(a Delaware limited liability company). (Attachments: # 1 Declaration, # 2 Proposed Order, # 3 Exhibit Public Redaction Version of Samsung's Opposition, # 4 Declaration Gordon Dec ISO Samsung's Opposition, # 5 Exhibit Exhibit 1 to Gordon's Dec, # 6 Exhibit Exhibit 2 to Gordon's Dec, # 7 Exhibit Exhibit 3 to Gordon's Dec, # 8 Exhibit Exhibit 4 to Gordon's Dec, # 9 Declaration Martin Dec ISO Samsung's Opposition, # 10 Exhibit Exhibit 1 to Martin's Dec, # 11 Exhibit Exhibit 10 to Martin's Dec, # 12 Exhibit Exhibit 11 to Martin's Dec, # 13 Exhibit Exhibit 12 to Martin's Dec, # 14 Exhibit Exhibit 13 to Martin's Dec, # 15 Declaration Price's Dec ISO Samsung's Opposition, # 16 Exhibit Exhibit 2 to Price's Dec, # 17 Exhibit Exhibit 5 to Price's Dec, # 18 Exhibit Exhibit 6 to Price's Dec, # 19 Exhibit Exhibit 8 to Price's Dec, # 20 Exhibit Exhibit 11 to Price's Dec, # 21 Exhibit Exhibit 13 to Price's Dec, # 22 Declaration Sheppard's Dec ISO Samsung's Opposition, # 23 Certificate/Proof of Service)(Maroulis, Victoria) (Filed on 3/13/2012) (Entered: 03/13/2012)
- 03/13/2012 802 ORDER by Judge Paul S. Grewal denying as moot 638 Stipulation (psglc2, COURT STAFF) (Filed on 3/13/2012) (Entered: 03/13/2012)
- 03/13/2012 803 Correction of Opposition/Response or Reply Deadlines pertaining to 800 MOTION Administrative Motion for Relief from Lead Counsel Meet and Confer Requirement or Extension of Deadline to File Motions (Reason: Correcting an error) filed by Samsung Electronics America, Inc., Samsung Electronics Co. Ltd., Samsung Telecommunications America, LLC. Responses due by 3/16/2012. (Maroulis, Victoria) (Filed on 3/13/2012) (Entered: 03/13/2012)
- 03/13/2012 805 OPPOSITION to ( 800 MOTION Administrative Motion for Relief from Lead Counsel Meet and Confer Requirement or Extension of Deadline to File Motions filed by Apple Inc..



- (Attachments: # 1 Proposed Order)(Jacobs, Michael) (Filed on 3/13/2012) Modified text on 3/14/2012 (dhm, COURT STAFF). (Entered: 03/13/2012)
- 03/13/2012 806 DECLARATION of Michael A. Jacobs in Support of 805 Opposition to Motion for Temporary Relief from the Lead Counsel Meet and Confer Requirement, filed by Apple Inc.. (Attachments: # 1 Exhibit A)(Related document(s) 805 ) (Jacobs, Michael) (Filed on 3/13/2012) Modified text on 3/14/2012 (dhm, COURT STAFF). (Entered: 03/13/2012)
- 03/13/2012 807 DECLARATION of Mia Mazza in Support of 805 Opposition to Administrative Motion for Temporary Relief from the Lead Counsel Meet and Confer Requirement or Alternatively for an Extension of the Deadline to File Motions to Compel, filed by Apple Inc.. (Attachments: # 1 Exhibit A, # 2 Exhibit B, # 3 Exhibit C, # 4 Exhibit D, # 5 Exhibit E, # 6 Exhibit F, # 7 Exhibit G, # 8 Exhibit H, # 9 Exhibit I, # 10 Exhibit J, # 11 Exhibit K, # 12 Exhibit L, # 13 Exhibit M, # 14 Exhibit N)(Related document(s) 805 ) (Jacobs, Michael) (Filed on 3/13/2012) Modified text on 3/14/2012 (dhm, COURT STAFF). (Entered: 03/13/2012)
- 03/14/2012 808 REPLY (re 800 MOTION Administrative Motion for Relief from Lead Counsel Meet and Confer Requirement or Extension of Deadline to File Motions ) filed by Samsung Electronics America, Inc., Samsung Electronics Co. Ltd., Samsung Telecommunications America, LLC. (Attachments: # 1 Declaration)(Maroulis, Victoria) (Filed on 3/14/2012) (Entered: 03/14/2012)
- 03/14/2012 809 ORDER by Judge Lucy H. Koh granting 794 Motion (lhkic2, COURT STAFF) (Filed on 3/14/2012) (Entered: 03/14/2012)
- 03/14/2012 810 STIPULATION AND ORDER RE SAMSUNG'S SUBPOENA TO THIRD PARTY WALMART by Judge Paul S. Grewal, granting 798 Stipulation (ofr, COURT STAFF) (Filed on 3/14/2012) (Entered: 03/14/2012)
- 03/14/2012 811 ORDER by Judge Lucy H. Koh denying 800 Motion (lhkic2, COURT STAFF) (Filed on 3/14/2012) (Entered: 03/14/2012)
- 03/14/2012 812 Declaration of Cyndi Wheeler in Support of 782 Administrative Motion to File Under Seal re Samsung's Motion Compel Production Materials From Related Proceedings and to Enforce 12/22/11 Court Order , 781 Administrative Motion to File Under Seal Declaration of Cyndi Wheeler in Support of Samsung's Administrative Motions to File Documents Under Seal filed by Apple Inc.. (Attachments: # 1 Exhibit 1)(Related document(s) 782 , 781 ) (Hung, Richard) (Filed on 3/14/2012) (Entered: 03/14/2012)
- 03/15/2012 813 REPLY (re 741 MOTION for Attorney Fees AND COSTS IN CONNECTION WITH MOTION TO COMPEL DEPOSITIONS OF 14 OF SAMSUNG'S PURPORTED "APEX" WITNESSES ) filed by Apple Inc.. (Jacobs, Michael) (Filed on 3/15/2012) (Entered: 03/15/2012)
- 03/15/2012 814 Declaration of Mia Mazza in Support of 813 Reply to Opposition/Response filed by Apple Inc.. (Attachments: # 1 Exhibit 1, # 2 Exhibit 2)(Related document(s) 813 ) (Jacobs, Michael) (Filed on 3/15/2012) (Entered: 03/15/2012)
- 03/15/2012 815 Administrative Motion to File Under Seal Apple Inc.'s Notice of Motion and Motion to Compel filed by Apple Inc.(a California corporation). (Attachments: # 1 Apple Inc.'s Notice of Motion and Motion to Compel, # 2 Declaration of S. Calvin Walden in Support of Apple Inc.'s Notice of Motion and Motion to Compel, # 3 Exhibit 1, # 4 Exhibit 2, # 5 Exhibit 3, # 6 Exhibit 4, # 7 Exhibit 5, # 8 Exhibit 6, # 9 Exhibit 7, # 10 Exhibit 8, # 11 Exhibit 9, # 12 Exhibit 10, # 13 Exhibit 11, # 14 Exhibit 12, # 15 Exhibit 13, # 16 Exhibit 14, # 17 [Proposed] Order Granting Apple's Motion to Compel)(Selwyn, Mark) (Filed on 3/15/2012) (Entered: 03/15/2012)
- 03/15/2012 816 CERTIFICATE OF SERVICE by Apple Inc.(a California corporation) re 815 Administrative Motion to File Under Seal Apple Inc.'s Notice of Motion and Motion to Compel (Selwyn, Mark) (Filed on 3/15/2012) (Entered: 03/15/2012)
- 03/16/2012 817 Declaration of Cyndi Wheeler in Support of 797 Order on Administrative Motion to File Under Seal, Order on Motion to Remove Incorrectly Filed Document,,,, filed by Apple Inc.. (Attachments: # 1 Exhibit 1, # 2 Exhibit 2)(Related document(s) 797 ) (Bartlett, Jason) (Filed on 3/16/2012) (Entered: 03/16/2012)
- 03/19/2012 818 Transcript of Proceedings held on 03/06/2012, before Judge Paul S. Grewal. Court Reporter/Transcriber Summer Fisher, Telephone number 408-288-6150. Per General Order No. 59 and Judicial Conference policy, this transcript may be viewed only at the Clerks Office public terminal or may be purchased through the Court Reporter/Transcriber until the deadline for the Release of Transcript Restriction. After that date it may be obtained through PACER. Any Notice of Intent to Request Redaction, if required, is due no later than 5 business days from date of this filing. Release of Transcript Restriction set for 6/18/2012. (Fisher, Summer) (Filed on 3/19/2012)

(Entered: 03/19/2012)

- 03/20/2012 819 Administrative Motion to File Under Seal filed by Samsung Electronics America, Inc., Samsung Electronics Co. Ltd., Samsung Telecommunications America, LLC. (Attachments: # 1 Declaration of Kang ISO Motion to Seal DECLARATION UNDER SEAL, # 2 Exhibit 1 to Kang: Redacted Samsung's Reply ISO Motion for Protective Order, # 3 Exhibit 2 to Kang: Declaration of Kang ISO Samsung's Reply ISO Motion for Protective Order, # 4 Declaration of Kassabian ISO Samsung's Reply ISO Motion for Protective Order, # 5 Exhibit A to Kassabian, # 6 Exhibit B to Kassabian, # 7 Exhibit C to Kassabian, # 8 Exhibit D to Kassabian, # 9 Exhibit E to Kassabian, # 10 Exhibit F to Kassabian, # 11 Exhibit G to Kassabian, # 12 Exhibit H to Kassabian, # 13 Exhibit I to Kassabian, # 14 Exhibit J to Kassabian, # 15 Exhibit K to Kassabian, # 16 Exhibit L to Kassabian, # 17 Exhibit M to Kassabian, # 18 Exhibit N to Kassabian, # 19 Exhibit O to Kassabian, # 20 Exhibit P to Kassabian, # 21 Exhibit Q to Kassabian, # 22 Exhibit R to Kassabian, # 23 Exhibit S to Kassabian, # 24 Exhibit T to Kassabian, # 25 Exhibit U to Kassabian, # 26 Proposed Order Granting Motio to Seal, # 27 Proposed Order Granting's Samsung's Motion for Protective Order Precluding the Depositions of Six High Ranking Executives)(Maroulis, Victoria) (Filed on 3/20/2012) Modified on 3/21/2012 Sealing Declaration of Kang (dhm, COURT STAFF). (Entered: 03/20/2012)
- 03/20/2012 820 Declaration of Cyndi Wheeler in Support of 801 Administrative Motion to File Under Seal filed by Apple Inc.. (Attachments: # 1 Exhibit 1)(Related document(s) 801 ) (Hung, Richard) (Filed on 3/20/2012) (Entered: 03/20/2012)
- 03/20/2012 821 ORDER by Judge Paul S. Grewal granting in part and denying in part 700 Motion to Compel (psglc2, COURT STAFF) (Filed on 3/20/2012) (Entered: 03/20/2012)
- 03/20/2012 822 Administrative Motion to File Under Seal filed by Apple Inc.. (Attachments: # 1 Proposed Order, # 2 [Redacted Public Version] Apple's Reply Brief, # 3 [Redacted Public Version] Olson Reply Declaration, # 4 Exhibit C to [Redacted Public Version] Olson Reply Declaration, # 5 Exhibit E to [Redacted Public Version] Olson Reply Declaration, # 6 Exhibit G to [Redacted Public Version] Olson Reply Declaration, \*\*\* DOCUMENT LOCKED [822-7] AT FILER'S REQUEST. \*\*\* # 7 Exhibit I to [Redacted Public Version] Olson Reply Declaration, # 8 [Redacted Public Version] Roberts Reply Declaration, # 9 [Redacted Public Version] Kim Reply Declaration, # 10 Exhibit 1 to [Redacted Public Version] Kim Reply Declaration, # 11 Exhibit 2 to [Redacted Public Version] Kim Reply Declaration, # 12 Exhibit 3 to [Redacted Public Version] Kim Reply Declaration, # 13 Exhibit 4 to [Redacted Public Version] Kim Reply Declaration, # 14 Exhibit 5 to [Redacted Public Version] Kim Reply Declaration, # 15 Exhibit 6 to [Redacted Public Version] Kim Reply Declaration, # 16 Exhibit 7 to [Redacted Public Version] Kim Reply Declaration, # 17 Exhibit 8 Part 1 to [Redacted Public Version] Kim Reply Declaration, # 18 Exhibit 8 Part 2 to [Redacted Public Version] Kim Reply Declaration, # 19 Exhibit 11 to [Redacted Public Version] Kim Reply Declaration, # 20 Exhibit 12 to [Redacted Public Version] Kim Reply Declaration, # 21 Certificate/Proof of Service)(Jacobs, Michael) (Filed on 3/20/2012) Modified on 3/21/2012 (wv, COURT STAFF). Modified on 3/21/2012 (wv, COURT STAFF). (Entered: 03/20/2012)
- 03/21/2012 823 MOTION to Remove Incorrectly Filed Document [Docket 822-7] filed by Apple Inc.. (Attachments: # 1 Proposed Order)(Jacobs, Michael) (Filed on 3/21/2012) (Entered: 03/21/2012)
- 03/21/2012 824 Administrative Motion to File Under Seal Exhibit I to the Reply Declaration of Erik J. Olson in Support of Apple's Rule 37(b)(2) Motion re Samsung's Violation of January 27, 2012 Damages Discovery Order filed by Apple Inc.. (Attachments: # 1 Proposed Order) (Jacobs, Michael) (Filed on 3/21/2012) (Entered: 03/21/2012)
- 03/21/2012 825 OPPOSITION to ( 782 Administrative Motion to File Under Seal re Samsung's Motion Compel Production Materials From Related Proceedings and to Enforce 12/22/11 Court Order ) filed by Apple Inc.. (Attachments: # 1 Nathan Sabri Declaration, # 2 Exhibit 1, # 3 Exhibit 2, # 4 Exhibit 3, # 5 Exhibit 4, # 6 Exhibit 5, # 7 Exhibit 6, # 8 Exhibit 7, # 9 Exhibit 8, # 10 Proposed Order)(Jacobs, Michael) (Filed on 3/21/2012) Modified text on 3/22/2012 (dhm, COURT STAFF). (Entered: 03/21/2012)
- 03/21/2012 826 Declaration of Joby Martin in Support of 759 Administrative Motion to File Under Seal filed by Samsung Electronics America, Inc.(a New York corporation), Samsung Electronics Co. Ltd., Samsung Telecommunications America, LLC(a Delaware limited liability company). (Attachments: # 1 Proposed Order)(Related document(s) 759 ) (Maroulis, Victoria) (Filed on 3/21/2012) (Entered: 03/21/2012)
- 03/21/2012 827 OPPOSITION to ( 781 Administrative Motion to File Under Seal ) Apple's Opposition to Samsung's Motion to Compel Production of Documents Relating to Apple's Efforts to Obtain Design Patents Related to the Patents-in-Suit filed by Apple Inc.. (Attachments: #

- 1 Jason Bartlett Declaration, # 2 Exhibit 1, # 3 Exhibit 2, # 4 Proposed Order)(Jacobs, Michael) (Filed on 3/21/2012) Modified text on 3/22/2012 (dhm, COURT STAFF). (Entered: 03/21/2012)
- 03/21/2012 828 CORRECTED REPLY BRIEF (re 822 Administrative Motion to File Under Seal ) [REDACTED PUBLIC VERSION] filed by Apple Inc.. (Jacobs, Michael) (Filed on 3/21/2012) Modified text on 3/22/2012 (dhm, COURT STAFF). (Entered: 03/21/2012)
- 03/22/2012 829 NOTICE by Apple Inc. re 828 Reply to Opposition/Response NOTICE OF LODGMNT OF APPLE'S CORRECTED REPLY BRIEF IN SUPPORT OF RULE 37(B)(2) MOTION (Jacobs, Michael) (Filed on 3/22/2012) (Entered: 03/22/2012)
- 03/22/2012 830 NOTICE by Apple Inc. re 822 Administrative Motion to File Under Seal NOTICE OF LODGMNT OF CORRECTED EXHIBIT I TO THE REPLY DECLARATION OF ERIK J. OLSON (Jacobs, Michael) (Filed on 3/22/2012) (Entered: 03/22/2012)
- 03/22/2012 831 NOTICE by Apple Inc. re 822 Administrative Motion to File Under Seal NOTICE OF LODGMNT OF CORRECTED EXHIBIT A TO THE REPLY DECLARATION OF ERIC R. ROBERTS (Jacobs, Michael) (Filed on 3/22/2012) (Entered: 03/22/2012)
- 03/22/2012 832 CERTIFICATE OF SERVICE by Apple Inc. re 822 Administrative Motion to File Under Seal (Jacobs, Michael) (Filed on 3/22/2012) (Entered: 03/22/2012)
- 03/22/2012 833 STIPULATION WITH PROPOSED ORDER Re Discovery filed by Apple Inc.. (Hung, Richard) (Filed on 3/22/2012) (Entered: 03/22/2012)
- 03/23/2012 834 RESPONSE (re 795 MOTION for Sanctions Apple's Rule 37(b)(2) Motion Based on Samsung's Violation of the Court's December 22, 2011 Order Regarding Source Code ) filed by Samsung Electronics America, Inc., Samsung Electronics Co. Ltd., Samsung Telecommunications America, LLC. (Attachments: # 1 Exhibit Exhibit A - Proposed Stipulation, # 2 Declaration Declaration of Todd Briggs, # 3 Exhibit Exhibit 1, # 4 Exhibit Exhibit 2, # 5 Proposed Order)(Maroulis, Victoria) (Filed on 3/23/2012) (Entered: 03/23/2012)
- 03/27/2012 835 Declaration of Cyndi Wheeler in Support of 819 Administrative Motion to File Under Seal filed by Apple Inc.. (Attachments: # 1 Exhibit 1, # 2 Exhibit 2, # 3 Exhibit 3)(Related document(s) 819 ) (Hung, Richard) (Filed on 3/27/2012) (Entered: 03/27/2012)
- 03/27/2012 836 ORDER by Judge Lucy H. Koh denying 658 Motion for Leave to File (lhklc2, COURT STAFF) (Filed on 3/27/2012) (Entered: 03/27/2012)
- 03/27/2012 837 Minute Entry: Motion Hearing held on 3/27/2012 before Magistrate Judge Paul S. Grewal (Date Filed: 3/27/2012) re 741 MOTION for Attorney Fees AND COSTS IN CONNECTION WITH MOTION TO COMPEL DEPOSITIONS OF 14 OF SAMSUNG'S PURPORTED "APEX" WITNESSES filed by Apple Inc., 754 Administrative Motion to File Under Seal filed by Samsung Electronics Co. Ltd., Samsung Telecommunications America, LLC, Samsung Electronics America, Inc., 715 Administrative Motion to File Under Seal Apple's Administration to File Documents Under Seal filed by Apple Inc., 736 Administrative Motion to File Under Seal filed by Apple Inc. The Court takes matters under submission; written order after hearing to be issued. (Court Reporter: Christine Bedard and Lee-Anne Shortridge.) (ofr, COURT STAFF) (Date Filed: 3/27/2012) (Entered: 03/28/2012)
- 03/28/2012 838 REPLY (re 781 Administrative Motion to File Under Seal ) filed by Samsung Electronics America, Inc., Samsung Electronics Co. Ltd., Samsung Telecommunications America, LLC. (Attachments: # 1 Declaration, # 2 Exhibit A)(Maroulis, Victoria) (Filed on 3/28/2012) (Entered: 03/28/2012)
- 03/28/2012 839 REPLY (re 782 Administrative Motion to File Under Seal re Samsung's Motion Compel Production Materials From Related Proceedings and to Enforce 12/22/11 Court Order ) filed by Samsung Electronics America, Inc., Samsung Electronics Co. Ltd., Samsung Telecommunications America, LLC. (Attachments: # 1 Declaration, # 2 Exhibit A, # 3 Exhibit B, # 4 Exhibit C, # 5 Exhibit D, # 6 Exhibit E, # 7 Exhibit F)(Maroulis, Victoria) (Filed on 3/28/2012) (Entered: 03/28/2012)
- 03/29/2012 840 ORDER Re Request to Change Time on Upcoming Discovery Hearings. Signed by Judge Paul S. Grewal on 3/29/2012. (psglc2, COURT STAFF) (Filed on 3/29/2012) (Entered: 03/29/2012)
- 03/29/2012 842 STIPULATION AND ORDER RE: DISCOVERY by Judge Paul S. Grewal, granting 833 Stipulation (ofr, COURT STAFF) (Filed on 3/29/2012) (Entered: 03/30/2012)
- 03/30/2012 841 MEMORANDUM OF POINTS AND AUTHORITIES IN OPPOSITION to ( 815 Administrative Motion to File Under Seal Apple Inc.'s Notice of Motion and Motion to Compel ) filed by Samsung Electronics America, Inc.(a New York corporation), Samsung Electronics Co. Ltd., Samsung Telecommunications America, LLC(a Delaware limited liability company).

(Attachments: # 1 Declaration Declaration of Joby Martin In Support of Samsung's Opposition to Apple's Motion to Compel, # 2 Exhibit 1, # 3 Exhibit 2, # 4 Exhibit 4, # 5 Exhibit 5, # 6 Exhibit 6, # 7 Exhibit 7, # 8 Exhibit 8, # 9 Proposed Order)(Maroulis, Victoria) (Filed on 3/30/2012) Modified text on 4/2/2012 (dhm, COURT STAFF). (Entered: 03/30/2012)

- 03/30/2012 843 EXHIBIT 3 to 841 the Declaration of Joby Martin In Support of Samsung's Opposition to Apple's Motion to Compel filed by Samsung Electronics America, Inc.(a New York corporation), Samsung Electronics Co. Ltd., Samsung Telecommunications America, LLC (a Delaware limited liability company). (Maroulis, Victoria) (Filed on 3/30/2012) Modified on 4/2/2012 linking entry to document 841 (dhm, COURT STAFF). (Entered: 03/30/2012)
- 03/30/2012 844 REPLY (re 795 MOTION for Sanctions Apple's Rule 37(b)(2) Motion Based on Samsung's Violation of the Court's December 22, 2011 Order Regarding Source Code ) filed by Apple Inc.. (Jacobs, Michael) (Filed on 3/30/2012) (Entered: 03/30/2012)
- 03/30/2012 845 Administrative Motion to File Under Seal Exhibit D to the Reply Declaration of Marc J. Pernick in Support of Apple's Rule 37(b)(2) Motion Based on Samsung's Violation of the Court's December 22, 2011 Order Regarding Source Code filed by Apple Inc.. (Attachments: # 1 Proposed Order, # 2 Pernick Reply Declaration, # 3 Exhibit A, # 4 Exhibit B, # 5 Exhibit C)(Jacobs, Michael) (Filed on 3/30/2012) (Entered: 03/30/2012)
- 04/02/2012 846 CLERK'S NOTICE RESETTING HEARING ON DISCOVERY MOTIONS (In Re: Docket Nos. 759 , 781 and 782 .: Motions reset to 4/9/2012 at 10:00 AM (Special Set) in Courtroom 5, 4th Floor, San Jose before Magistrate Judge Paul Singh Grewal. \*\*\*This is a text only docket entry, there is no document associated with this notice.\*\*\* (ofr, COURT STAFF) (Filed on 4/2/2012) (Entered: 04/02/2012)
- 04/02/2012 847 Administrative Motion to File Under Seal Samsung's Opposition to Apple's Motion for Partial Summary Judgment filed by Samsung Electronics Co. Ltd.. (Attachments: # 1 Trac Declaration in Support of Motion to File Under Seal, # 2 Samsung's Opposition to Apple's Motion for Partial Summary Judgment, # 3 Hecht Declaration in Support of Opposition to Motion for Partial Summary Judgment, # 4 Ex A, # 5 Ex B1, # 6 Ex B2, # 7 Ex C1, # 8 Ex C2, # 9 Ex D, # 10 Ex E, # 11 Ex F1, # 12 Ex F2, # 13 Ex F3, # 14 Ex F4, # 15 Ex G, # 16 Ex H, # 17 Ex I, # 18 Ex J1, # 19 Ex J2, # 20 Ex J3, # 21 Ex J4, # 22 Ex J5, # 23 Ex J6, # 24 Ex J7, # 25 Ex J8, # 26 Ex J9, # 27 Ex J10, # 28 Ex J11, # 29 Ex K1, # 30 Ex K2, # 31 Ex K3, # 32 Ex L, # 33 Ex M, # 34 Ex N, # 35 Ex O1, # 36 Ex O2, # 37 Ex P1, # 38 Ex P2, # 39 Ex Q1, # 40 Ex Q2, # 41 Ex Q3, # 42 Ex Q4, # 43 Ex Q5, # 44 Ex Q6, # 45 Ex Q7, # 46 Ex R, # 47 Ex S1, # 48 Ex S2, # 49 Rosenbrock Declaration in Support of Opposition to Motion for Partial Summary Judgment, # 50 Ex 1, # 51 Ex 2, # 52 Ex 3, # 53 Ex 4, # 54 Ex 5, # 55 Ex 6, # 56 Ex 7, # 57 Ex 8, # 58 Ex 9, # 59 Ex 10, # 60 Ex 11, # 61 Ex 12, # 62 Ex 13, # 63 Ex 14, # 64 Ex 15, # 65 Ex 16, # 66 Ex 17, # 67 Ex 18, # 68 Proposed Order Denying Apple's Motion for Summary Judgment, # 69 Proposed Order Granting Samsung's Administrative Motion to File Under Seal)(Maroulis, Victoria) (Filed on 4/2/2012) Modified on 4/3/2012 Attachment #1 Trac Declaration placed under seal. Posting of attachments #16, 18, 19, 20 through 33, 37, 38, 47 and 48 are NOT in compliance with General Order 62 (dhm, COURT STAFF). (Entered: 04/02/2012)
- 04/02/2012 848 CERTIFICATE OF SERVICE by Samsung Electronics Co. Ltd. re 847 Administrative Motion to File Under Seal Samsung's Opposition to Apple's Motion for Partial Summary Judgment (Maroulis, Victoria) (Filed on 4/2/2012) (Entered: 04/02/2012)
- 04/04/2012 849 ORDER Construing Disputed Claim Terms. Signed by Judge Lucy H. Koh on 4/4/2012. (lhkic2, COURT STAFF) (Filed on 4/4/2012) (Entered: 04/04/2012)
- 04/04/2012 850 ORDER GRANTING-IN-PART Motion to Compel re 736 Administrative Motion to File Under Seal filed by Apple Inc., and GRANTING-IN-PART Motion for Protective Order re 754 Administrative Motion to File Under Seal filed by Samsung Electronics Co. Ltd., Samsung Telecommunications America, LLC, Samsung Electronics America, Inc. Signed by Judge Paul S. Grewal on 4/4/2012. (psglc2, COURT STAFF) (Filed on 4/4/2012) (Entered: 04/04/2012)
- 04/05/2012 851 STIPULATION WITH PROPOSED ORDER re 841 Opposition/Response to Motion,, Extending the Deadline to File a Reply in Support of Apple's Motion to Compel filed by Apple Inc.(a California corporation). (Selwyn, Mark) (Filed on 4/5/2012) (Entered: 04/05/2012)
- 04/05/2012 852 CASE MANAGEMENT STATEMENT Joint Case Management Conference Statement filed by Apple Inc.. (Hung, Richard) (Filed on 4/5/2012) (Entered: 04/05/2012)
- 04/06/2012 853 JOINT STIPULATION AND ORDER EXTENDING THE DEADLINE TO FILE A REPLY IN

SUPPORT OF APPLES MOTION TO COMPEL by Judge Paul S. Grewal, granting 851 Stipulation (ofr, COURT STAFF) (Filed on 4/6/2012) (Entered: 04/06/2012)

- 04/06/2012 854 NOTICE by Samsung Electronics America, Inc., Samsung Electronics Co. Ltd., Samsung Telecommunications America, LLC re 782 Administrative Motion to File Under Seal re Samsung's Motion Compel Production Materials From Related Proceedings and to Enforce 12/22/11 Court Order Notice of In Camera Submission (Maroulis, Victoria) (Filed on 4/6/2012) (Entered: 04/06/2012)
- 04/06/2012 855 Transcript of Proceedings held on 03-27-12, before Judge Paul S. Grewal. Court Reporter/Transcriber Lee-Anne Shortridge, Telephone number 408-287-4580. Per General Order No. 59 and Judicial Conference policy, this transcript may be viewed only at the Clerks Office public terminal or may be purchased through the Court Reporter/Transcriber until the deadline for the Release of Transcript Restriction. After that date it may be obtained through PACER. Any Notice of Intent to Request Redaction, if required, is due no later than 5 business days from date of this filing. Release of Transcript Restriction set for 7/5/2012. (las, ) (Filed on 4/6/2012) (Entered: 04/06/2012)
- 04/07/2012 856 MOTION for Leave to File Supplemental Response to Apple's Corrected Reply In Support of Rule 37(b)(2) Motion filed by Samsung Electronics America, Inc.(a New York corporation), Samsung Electronics Co. Ltd., Samsung Telecommunications America, LLC (a Delaware limited liability company). (Attachments: # 1 Proposed Order)(Maroulis, Victoria) (Filed on 4/7/2012) (Entered: 04/07/2012)
- 04/07/2012 857 Administrative Motion to File Under Seal Samsung's Supplemental Response to Apple's Corrected Reply In Support of Rule 37(b)(2) Motion, filed by Samsung Electronics America, Inc.(a New York corporation), Samsung Electronics Co. Ltd., Samsung Telecommunications America, LLC(a Delaware limited liability company). (Attachments: # 1 Exhibit Public Redacted Version of Samsung's Supplemental Response, # 2 Declaration of Christopher Price In Support of Samsung's Supplemental Response, # 3 Exhibit A (filed under seal), # 4 Exhibit B (filed under seal), # 5 Exhibit C (filed under seal), # 6 Exhibit D, # 7 Exhibit E, # 8 Exhibit F, # 9 Exhibit G, # 10 Exhibit H, # 11 Exhibit I (filed under seal), # 12 Exhibit J (filed under seal), # 13 Exhibit K (filed under seal), # 14 Declaration of Joby Martin In Support of Samsung's Administrative Motion to File Documents Under Seal, # 15 Proposed Order Granting Samsung's Administrative Motion to File Documents Under Seal)(Maroulis, Victoria) (Filed on 4/7/2012) (Entered: 04/07/2012)
- 04/07/2012 858 RESPONSE (re 856 MOTION for Leave to File Supplemental Response to Apple's Corrected Reply In Support of Rule 37(b)(2) Motion ) Apple's Opposition to Samsung's Administrative Request for Leave to File a Sur-Reply to Apple's Reply in Support of Rule 37(b)(2) Motion re Samsung's Violation of January 27, 2012 Damages Discovery Order filed by Apple Inc.. (Attachments: # 1 Proposed Order)(Jacobs, Michael) (Filed on 4/7/2012) (Entered: 04/07/2012)
- 04/09/2012 859 Declaration of Erica Tierney in Support of 847 Administrative Motion to File Under Seal Samsung's Opposition to Apple's Motion for Partial Summary Judgment filed by Apple Inc. (a California corporation). (Attachments: # 1 Exhibit 1, # 2 Exhibit 2)(Related document (s) 847 ) (Selwyn, Mark) (Filed on 4/9/2012) (Entered: 04/09/2012)
- 04/09/2012 860 Declaration of Mark D. Selwyn in Support of 847 Administrative Motion to File Under Seal Samsung's Opposition to Apple's Motion for Partial Summary Judgment filed by Apple Inc. (a California corporation). (Attachments: # 1 Exhibit 1)(Related document(s) 847 ) (Selwyn, Mark) (Filed on 4/9/2012) (Entered: 04/09/2012)
- 04/09/2012 861 Proposed Order re 847 Administrative Motion to File Under Seal Samsung's Opposition to Apple's Motion for Partial Summary Judgment by Apple Inc.(a California corporation). (Selwyn, Mark) (Filed on 4/9/2012) (Entered: 04/09/2012)
- 04/09/2012 862 CERTIFICATE OF SERVICE by Apple Inc.(a California corporation) re 860 Declaration in Support, 859 Declaration in Support, (Selwyn, Mark) (Filed on 4/9/2012) (Entered: 04/09/2012)
- 04/09/2012 865 Minute Entry: Motion Hearing held on 4/9/2012 before Magistrate Judge Paul S. Grewal (Date Filed: 4/9/2012) re 782 Administrative Motion to File Under Seal re Samsung's Motion Compel Production Materials From Related Proceedings and to Enforce 12/22/11 Court Order filed by Samsung Electronics Co. Ltd., Samsung Telecommunications America, LLC, Samsung Electronics America, Inc., 759 Administrative Motion to File Under Seal filed by Apple Inc., 781 Administrative Motion to File Under Seal filed by Samsung Electronics Co. Ltd., Samsung Telecommunications America, LLC, Samsung Electronics America, Inc. The Court takes matters under submission; written order after

- hearing to be issued. (Court Reporter: Summer Fisher.) (ofr, COURT STAFF) (Date Filed: 4/9/2012) (Entered: 04/11/2012)
- 04/10/2012 863 ORDER by Judge Paul S. Grewal denying 856 Motion for Leave to File (psglc2, COURT STAFF) (Filed on 4/10/2012) (Entered: 04/10/2012)
- 04/10/2012 864 STIPULATION WITH PROPOSED ORDER re 815 Administrative Motion to File Under Seal Apple Inc.'s Notice of Motion and Motion to Compel Joint Stipulation and [Proposed Order] Regarding Samsung's Production of Documents and Withdrawing Apple's Motion to Compel filed by Apple Inc.(a California corporation). (Selwyn, Mark) (Filed on 4/10/2012) (Entered: 04/10/2012)
- 04/11/2012 866 JOINT STIPULATION AND ORDER REGARDING SAMSUNGS PRODUCTION OF DOCUMENTS AND WITHDRAWING APPLES MOTION TO COMPEL by Judge Paul S. Grewal, re 864 Stipulation (ofr, COURT STAFF) (Filed on 4/11/2012) (Entered: 04/11/2012)
- 04/12/2012 867 ORDER GRANTING-IN-PART 782 Samsung's Motion to Compel Production Materials From Related Proceedings and to Enforce 12/22/11 Court Order filed by Samsung Electronics Co. Ltd., Samsung Telecommunications America, LLC, Samsung Electronics America, Inc., and GRANTING-IN-PART 781 Samsung's Motion to Compel Production filed by Samsung Electronics Co. Ltd., Samsung Telecommunications America, LLC, Samsung Electronics America, Inc. Signed by Judge Paul S. Grewal on 4/12/2012. (psglc2, COURT STAFF) (Filed on 4/12/2012) (Entered: 04/12/2012)
- 04/12/2012 868 ORDER by Magistrate Judge Paul Singh Grewal DENYING 741 Motion for Attorney Fees. Samsung's position on the depositions requested by Apple, while incorrect, was nevertheless substantially justified. Under these circumstances, an award of reasonable expenses, including attorney's fees, is not warranted. See Fed. R. Civ. P. 37(a)(5)(A)(ii). (Magistrate Judge Paul S. Grewal) (Filed on 4/12/2012) (Entered: 04/12/2012)
- 04/12/2012 869 Case Management Order. Signed by Judge Lucy H. Koh on 4/12/12. (lhkic3, COURT STAFF) (Filed on 4/12/2012) (Entered: 04/13/2012)
- 04/12/2012 871 Minute Entry: Motion Hearing held on 4/12/2012 before Judge Lucy H. Koh (Date Filed: 4/12/2012) re 405 MOTION to Dismiss Apple's Amended Counterclaims filed by Samsung Electronics Co. Ltd., Samsung Telecommunications America, LLC, Samsung Electronics America, Inc., Further Case Management Conference held on 4/12/2012 before Judge Lucy H. Koh (Date Filed: 4/12/2012). (Court Reporter Lee-Anne Shortridge.) (mpb, COURT STAFF) (Date Filed: 4/12/2012) (Entered: 04/16/2012)
- 04/13/2012 870 NOTICE of Intent to Request Redaction of Transcript by Victoria F. Maroulis on Behalf of Samsung (Maroulis, Victoria) (Filed on 4/13/2012) (Entered: 04/13/2012)
- 04/16/2012 872 NOTICE by Apple Inc.(a California corporation) of Withdrawal of Its Motion for Partial Summary Judgment 660 (Selwyn, Mark) (Filed on 4/16/2012) (Entered: 04/16/2012)
- 04/16/2012 873 JOINT STATUS REPORT by Apple Inc., Samsung Electronics America, Inc.(a New York corporation), Samsung Electronics Co. Ltd., Samsung Telecommunications America, LLC (a Delaware limited liability company). (Maroulis, Victoria) (Filed on 4/16/2012) Modified text on 4/17/2012 (dhm, COURT STAFF). (Entered: 04/16/2012)
- 04/17/2012 874 ORDER Referring Parties to ADR. Signed by Judge Lucy H. Koh on 4/17/2012. (lhkic2, COURT STAFF) (Filed on 4/17/2012) (Entered: 04/17/2012)
- 04/19/2012 875 STIPULATION WITH PROPOSED ORDER REGARDING INTEL CODE PRODUCTION filed by Apple Inc.(a California corporation). (Selwyn, Mark) (Filed on 4/19/2012) (Entered: 04/19/2012)
- 04/20/2012 876 STIPULATED AMENDMENT TO THE PROTECTIVE ORDER REGARDING INTEL CODE PRODUCTION by Judge Paul S. Grewal, granting 875 Stipulation (ofr, COURT STAFF) (Filed on 4/20/2012) (Entered: 04/20/2012)
- 04/20/2012 877 ADMINISTRATIVE REQUEST For Leave To File Supplemental Declaration Of Erik J. Olson In Support Of Apples Rule 37(B)(2) Motion Re Samsungs Violation Of January 27, 2012 Damages Discovery Order filed by Apple Inc.. (Attachments: # 1 Declaration of Erik J. Olson ISO Rule 37(b)(2) re Damages, # 2 Exhibit A, # 3 Exhibit B, # 4 Exhibit C, # 5 Proposed Order)(Tucher, Alison) (Filed on 4/20/2012) Modified text on 4/23/2012 (dhm, COURT STAFF). (Entered: 04/20/2012)
- 04/22/2012 878 OPPOSITION to ( 877 ADMINISTRATIVE REQUEST for Leave to File Supplemental Declaration Of Erik J. Olson In Support Of Apples Rule 37(B)(2) Motion Re Samsungs Violation Of January 27, 2012 Damages Discovery Order ) Opposition filed by Samsung Electronics Co. Ltd.. (Attachments: # 1 Declaration of Anderson in support, # 2 Exhibit A, # 3 Exhibit B)(Maroulis, Victoria) (Filed on 4/22/2012) Modified text on 4/23/2012 (dhm, COURT STAFF). (Entered: 04/22/2012)

- 04/23/2012 879 ORDER DENYING ADMINISTRATIVE REQUEST FOR LEAVE TO FILE SUPPLEMENTAL DECLARATION OF ERIK J. OLSON by Judge Paul S. Grewal, denying 877 Motion for Leave to File (ofr, COURT STAFF) (Filed on 4/23/2012) (Entered: 04/23/2012)
- 04/23/2012 880 ORDER GRANTING-IN-PART re 759 Apple's Motion for 37(B)(2) Sanctions Re Damages Discovery; ORDER GRANTING-IN-PART re 715 Apple's Motion for 37(B)(2) Sanctions Re Sept. 28 and Dec. 22 Discovery Orders. Signed by Judge Paul S. Grewal on 4/23/2012. (psglc2, COURT STAFF) (Filed on 4/23/2012) (Entered: 04/23/2012)
- 04/23/2012 881 STATUS REPORT (Joint) by Samsung Electronics America, Inc.(a New York corporation), Samsung Electronics Co. Ltd., Samsung Telecommunications America, LLC(a Delaware limited liability company). (Maroulis, Victoria) (Filed on 4/23/2012) (Entered: 04/23/2012)
- 04/24/2012 882 NOTICE of Appearance by Michael Richard Heimbold on behalf of Kfir Levy (Heimbold, Michael) (Filed on 4/24/2012) (Entered: 04/24/2012)
- 04/24/2012 883 Minute Entry: Motion Hearing held on 4/24/2012 before Magistrate Judge Paul S. Grewal (Date Filed: 4/24/2012) re 795 MOTION for Sanctions Apple's Rule 37(b)(2) Motion Based on Samsung's Violation of the Court's December 22, 2011 Order Regarding Source Code filed by Apple Inc. The Court takes matter under submission; written order after hearing to be issued. (Court Reporter: Summer Fisher.) (ofr, COURT STAFF) (Date Filed: 4/24/2012) (Entered: 04/24/2012)
- 04/25/2012 884 Transcript of Proceedings held on 04/24/2012, before Judge Paul S. Grewal. Court Reporter/Transcriber Summer Fisher, Telephone number 408-288-6150. Per General Order No. 59 and Judicial Conference policy, this transcript may be viewed only at the Clerks Office public terminal or may be purchased through the Court Reporter/Transcriber until the deadline for the Release of Transcript Restriction. After that date it may be obtained through PACER. Any Notice of Intent to Request Redaction, if required, is due no later than 5 business days from date of this filing. Release of Transcript Restriction set for 7/24/2012. (Fisher, Summer) (Filed on 4/25/2012) (Entered: 04/25/2012)
- 04/26/2012 885 MOTION Administrative Relief Apples Administrative Motion For Clarification Of April 12 Order filed by Apple Inc. Responses due by 4/30/12. (Tucher, Alison) (Filed on 4/26/2012) Modified on 4/30/2012 (ofr, COURT STAFF). (Entered: 04/26/2012)
- 04/26/2012 886 MOTION Conditional Motion for Relief from Nondispositive Pretrial Order of Magistrate Judge Apple's Conditional Motion for Relief from Nondispositive Pretrial Order of Magistrate Judge filed by Apple Inc.. Responses due by 5/10/2012. Replies due by 5/17/2012. (Tucher, Alison) (Filed on 4/26/2012) (Entered: 04/26/2012)
- 04/26/2012 887 Declaration of Mia Mazza In Support Of Apples Administrative Motion For Clarification Regarding April 12 Order filed by Apple Inc.. (Attachments: # 1 Exhibit 1, # 2 Exhibit 2, # 3 Exhibit 3, # 4 Exhibit 4, # 5 Exhibit 5, # 6 Exhibit 6, # 7 Exhibit 7, # 8 Exhibit 8, # 9 Exhibit 9, # 10 Exhibit 10, # 11 Exhibit 11, # 12 Exhibit 12, # 13 Exhibit 13, # 14 Exhibit 14, # 15 Exhibit 15, # 16 Exhibit 16, # 17 Exhibit 17, # 18 Exhibit 18, # 19 Exhibit 19, # 20 Exhibit 20, # 21 Exhibit 21, # 22 Exhibit 22, # 23 Exhibit 23, # 24 Exhibit 24)(Tucher, Alison) (Filed on 4/26/2012) (Entered: 04/26/2012)
- 04/26/2012 888 Proposed Order Granting Apples Administrative Motion For Clarification Of April 12 Order by Apple Inc.. (Tucher, Alison) (Filed on 4/26/2012) (Entered: 04/26/2012)
- 04/27/2012 889 Notice of Settlement and Order Setting Settlement Conference before Magistrate Judge JOSEPH C. SPERO. Settlement Conference set for 5/21/2012 at 09:30 AM and 5/22/12 at 9:30 AM in Courtroom G, 15th Floor, San Francisco. Signed by Judge Joseph C. Spero on 4/27/12. (klhS, COURT STAFF) (Filed on 4/27/2012) (Entered: 04/27/2012)
- 04/27/2012 890 NOTICE of Withdrawal of 870 Notice of Intent to Request Redaction of Transcript by Samsung Electronics America, Inc.(a New York corporation), Samsung Electronics Co. Ltd., Samsung Telecommunications America, LLC(a Delaware limited liability company) (Maroulis, Victoria) (Filed on 4/27/2012) Modified on 5/15/2012 (dhm, COURT STAFF). (Entered: 04/27/2012)
- 04/27/2012 891 MOTION to Seal Portions of Hearing Transcript re 855 Transcript,, filed by Samsung Electronics America, Inc.(a New York corporation), Samsung Electronics Co. Ltd., Samsung Telecommunications America, LLC(a Delaware limited liability company). Motion Hearing set for 6/5/2012 10:00 AM in Courtroom 5, 4th Floor, San Jose before Magistrate Judge Paul Singh Grewal. Responses due by 5/11/2012. Replies due by 5/18/2012. (Attachments: # 1 Proposed Order Granting Motion to Seal Portions of Hearing Transcript Under General Order 59)(Maroulis, Victoria) (Filed on 4/27/2012) (Entered: 04/27/2012)

- 04/30/2012 892 OPPOSITION to ( 885 ADMINISTRATIVE MOTION For Clarification Of April 12 Order ) filed by Samsung Electronics America, Inc., Samsung Electronics Co. Ltd., Samsung Telecommunications America, LLC. (Attachments: # 1 Declaration, # 2 Exhibit A, # 3 Exhibit B, # 4 Exhibit C, # 5 Exhibit D, # 6 Exhibit E, # 7 Exhibit F, # 8 Exhibit G, # 9 Exhibit H, # 10 Exhibit I, # 11 Exhibit J, # 12 Exhibit K, # 13 Exhibit L, # 14 Exhibit M, # 15 Exhibit N, # 16 Exhibit O, # 17 Proposed Order)(Maroulis, Victoria) (Filed on 4/30/2012) Modified text on 5/1/2012 (dhm, COURT STAFF). (Entered: 04/30/2012)
- 05/01/2012 893 JOINT CASE MANAGEMENT STATEMENT filed by Apple Inc., Samsung Electronics America, Inc., Samsung Electronics Co. Ltd., Samsung Telecommunications America, LLC. (Maroulis, Victoria) (Filed on 5/1/2012) (Entered: 05/01/2012)
- 05/01/2012 894 REPLY (re 885 MOTION Administrative Relief Apples Administrative Motion For Clarification Of April 12 Order ) Reply In Support Of Apples Administrative Motion For Clarification of April 12 Order filed by Apple Inc.. (Tucher, Alison) (Filed on 5/1/2012) (Entered: 05/01/2012)
- 05/01/2012 895 Administrative Motion to File Under Seal filed by Apple Inc.. (Attachments: # 1 Apple Inc.s Motion For Adverse Inference Jury Instructions Due To Samsungs Spoliation Of Evidence, # 2 Declaration of Esther Kim ISO Apple Inc.s Motion For Adverse Inference Jury Instructions Due To Samsungs Spoliation Of Evidence, # 3 Exhibit 1, # 4 Exhibit 32, # 5 Exhibit 33, # 6 Proposed Order Granting Apple Inc.s Motion For Adverse Inference Jury Instructions Due To Samsungs Spoliation Of Evidence, # 7 Proposed Order Granting Apple's Administrative Motion to Seal Documents)(McElhinny, Harold) (Filed on 5/1/2012) (Entered: 05/01/2012)
- 05/01/2012 896 CERTIFICATE OF SERVICE by Apple Inc. (McElhinny, Harold) (Filed on 5/1/2012) (Entered: 05/01/2012)
- 05/02/2012 901 Minute Entry and Case Management Order: Further Case Management Conference held on 5/2/2012 before Judge Lucy H. Koh (Date Filed: 5/2/2012). Further Case Management Conference set for 6/21/2012 01:30 PM in Courtroom 8, 4th Floor, San Jose. (Court Reporter Summer Fisher.) (mpb, COURT STAFF) (Date Filed: 5/2/2012) (Entered: 05/07/2012)
- 05/03/2012 897 Minute Entry: Discovery Hearing held on 5/3/2012 before Magistrate Judge Paul S. Grewal (Date Filed: 5/3/2012). Counsel to update courtroom deputy no later than 9:00 a.m. on 5/4/12 as to whether dispute regarding expedited discovery resolved or to be addressed. (Court Reporter FTR: (12:13 to 12:31.) (ofr, COURT STAFF) (Date Filed: 5/3/2012) (Entered: 05/03/2012)
- 05/04/2012 898 ORDER by Judge Paul S. Grewal GRANTING 795 Motion for Sanctions (psglc3, COURT STAFF) (Filed on 5/4/2012) (Entered: 05/04/2012)
- 05/07/2012 899 MOTION for Extension of Time to File Response/Reply as to 895 Administrative Motion to File Under Seal filed by Samsung Electronics America, Inc.(a New York corporation), Samsung Electronics Co. Ltd., Samsung Telecommunications America, LLC(a Delaware limited liability company). (Attachments: # 1 Proposed Order Granting Motion to Extend Time, # 2 Declaration of Sara Jenkins in Support of Motion to Extend Time, # 3 Exhibit 1 to the Declaration of Sara Jenkins)(Maroulis, Victoria) (Filed on 5/7/2012) (Entered: 05/07/2012)
- 05/07/2012 900 NOTICE by Apple Inc.(a California corporation) Translations of Foreign Authority (Attachments: # 1 Exhibit 1, # 2 Exhibit 2, # 3 Exhibit 3, # 4 Exhibit 4, # 5 Exhibit 5, # 6 Exhibit 6, # 7 Exhibit 7, # 8 Exhibit 8, # 9 Exhibit 9, # 10 Exhibit 10, # 11 Exhibit 11, # 12 Exhibit 12, # 13 Exhibit 13, # 14 Exhibit 14, # 15 Exhibit 15, # 16 Exhibit 16, # 17 Exhibit 17, # 18 Exhibit 18, # 19 Exhibit 19, # 20 Exhibit 20, # 21 Exhibit 21, # 22 Exhibit 22, # 23 Exhibit 23, # 24 Exhibit 24, # 25 Exhibit 25, # 26 Exhibit 26, # 27 Exhibit 27, # 28 Exhibit 28, # 29 Exhibit 29, # 30 Exhibit 30, # 31 Exhibit 31, # 32 Exhibit 32, # 33 Exhibit 33, # 34 Exhibit 34, # 35 Exhibit 35, # 36 Exhibit 36, # 37 Exhibit 37, # 38 Exhibit 38, # 39 Exhibit 39, # 40 Exhibit 40, # 41 Exhibit 41, # 42 Exhibit 42, # 43 Exhibit 43, # 44 Exhibit 44, # 45 Exhibit 45, # 46 Exhibit 46, # 47 Exhibit 47, # 48 Exhibit 48, # 49 Exhibit 49, # 50 Exhibit 50, # 51 Exhibit 51, # 52 Exhibit 52, # 53 Exhibit 53, # 54 Exhibit 54, # 55 Exhibit 55, # 56 Exhibit 56, # 57 Exhibit 57, # 58 Exhibit 58, # 59 Exhibit 59, # 60 Exhibit 60, # 61 Exhibit 61, # 62 Exhibit 62, # 63 Exhibit 63)(Selwyn, Mark) (Filed on 5/7/2012) (Entered: 05/07/2012)
- 05/07/2012 902 Apple's Statement Identifying The Claims It Will Assert At Trial by Apple Inc.. (McElhinny, Harold) (Filed on 5/7/2012) Modified text on 5/8/2012 (dhm, COURT STAFF). (Entered: 05/07/2012)
- 05/07/2012 903 Apples Status Update Regarding Compliance With April 12 Order by Apple Inc.. (Bartlett, Jason) (Filed on 5/7/2012) Modified text on 5/8/2012 (dhm, COURT STAFF). (Entered: 05/07/2012)



05/07/2012)

- 05/07/2012 904 EXHIBITS re 903 Exhibit 1 to Apples Status Update Regarding Compliance With April 12 Order filed by Apple Inc.. (Related document(s) 903 ) (Bartlett, Jason) (Filed on 5/7/2012) Modified text on 5/8/2012 (dhm, COURT STAFF). (Entered: 05/07/2012)
- 05/07/2012 905 OPPOSITION to ( 899 MOTION for Extension of Time for Briefing and Hearing on 895 Administrative Motion to File Under Seal re Motion for Adverse Inference Jury Instructions filed by Apple Inc.. (Tucher, Alison) (Filed on 5/7/2012) Modified text on 5/9/2012 (dhm, COURT STAFF). (Entered: 05/07/2012)
- 05/07/2012 906 Declaration of Jason Bartlett In Support Of 759 Apples Petition For Attorneys Fees Pursuant To 880 The Courts April 23 Order filed by Apple Inc.. (Attachments: # 1 Exhibit 1, # 2 Exhibit 2)(Bartlett, Jason) (Filed on 5/7/2012) Modified on 5/9/2012 linking entry to document #759 and #880 (dhm, COURT STAFF). (Entered: 05/07/2012)
- 05/07/2012 907 Statement Identifying Claims Samsung Will Assert At Trial by Samsung Electronics America, Inc., Samsung Electronics Co. Ltd., Samsung Telecommunications America, LLC. (Maroulis, Victoria) (Filed on 5/7/2012) (Entered: 05/07/2012)
- 05/08/2012 908 Declaration of Hankil Kang in Support of 895 Administrative Motion to File Under Seal filed by Samsung Electronics America, Inc.(a New York corporation), Samsung Electronics Co. Ltd., Samsung Telecommunications America, LLC(a Delaware limited liability company). (Related document(s) 895 ) (Maroulis, Victoria) (Filed on 5/8/2012) (Entered: 05/08/2012)
- 05/09/2012 909 RESPONSE to re 903 Status Report by Samsung Electronics Co. Ltd.. (Maroulis, Victoria) (Filed on 5/9/2012) (Entered: 05/09/2012)
- 05/09/2012 910 MOTION for Leave to File Apple's Motion for Leave to File Response To Samsungs Statement Identifying Claims It Will Assert At Trial filed by Apple Inc.. (Attachments: # 1 Apples Response To Samsungs Statement Identifying Claims It Will Assert At Trial, # 2 Declaration Richard S.J. Hung Decl. ISO Apple's Motion for Leave to File Response to Samsung's Statement Identifying Claims It Will Assert, # 3 Exhibit 1, # 4 Proposed Order Proposed Order Granting Apple's Motion for Leave to File Response to Samsung's Statement Identifying Claims It Will Assert)(McElhinny, Harold) (Filed on 5/9/2012) (Entered: 05/09/2012)
- 05/09/2012 911 Statement re 885 MOTION Administrative Relief Apples Administrative Motion For Clarification Of April 12 Order Apples Supplemental Statement Of Additional Facts Regarding Motion For Clarification by Apple Inc.. (Attachments: # 1 Exhibit A, # 2 Exhibit B, # 3 Exhibit C, # 4 Exhibit D)(Bartlett, Jason) (Filed on 5/9/2012) (Entered: 05/09/2012)
- 05/09/2012 914 ORDER re 899 GRANTING-IN-PART SAMSUNG'S MOTION TO ENLARGE TIME FOR BRIEFING AND HEARING as to 895 filed by Samsung Electronics Co. Ltd., Samsung Telecommunications America, LLC, Samsung Electronics America, Inc. Signed by Judge Paul S. Grewal on 5/9/2012. (psglc2, COURT STAFF) (Filed on 5/11/2012) Modified on 5/14/2012 (ofr, COURT STAFF). (Entered: 05/11/2012)
- 05/09/2012 -- Set/Reset Hearing re 914 Order: Motion Hearing (In Re: Docket No. 895 ) set for 6/26/2012 at 10:00 AM in Courtroom 5, 4th Floor, San Jose before Magistrate Judge Paul Singh Grewal. (ofr, COURT STAFF) (Filed on 5/9/2012) (Entered: 05/14/2012)
- 05/10/2012 912 ORDER by Judge Lucy H. Koh Regarding Parties' Statements Narrowing Claims; denying 910 Motion for Leave to File (lhkic2, COURT STAFF) (Filed on 5/10/2012) (Entered: 05/10/2012)
- 05/11/2012 -- Set/Reset Hearing (mpb, COURT STAFF) (Filed on 5/11/2012) Modified on 5/11/2012 (mpb, COURT STAFF). (Entered: 05/11/2012)
- 05/11/2012 913 ORDER MOOTING MAY 3, 2012 DISCOVERY DISPUTE. Signed by Judge Paul S. Grewal on 5/9/2012. (psglc2, COURT STAFF) (Filed on 5/11/2012) (Entered: 05/11/2012)
- 05/11/2012 915 Transcript of Proceedings held on 05/02/2012, before Judge Lucy H. Koh. Court Reporter/Transcriber Summer Fisher, Telephone number 408-288-6150. Per General Order No. 59 and Judicial Conference policy, this transcript may be viewed only at the Clerks Office public terminal or may be purchased through the Court Reporter/Transcriber until the deadline for the Release of Transcript Restriction. After that date it may be obtained through PACER. Any Notice of Intent to Request Redaction, if required, is due no later than 5 business days from date of this filing. Release of Transcript Restriction set for 8/9/2012. (Fisher, Summer) (Filed on 5/11/2012) (Entered: 05/11/2012)
- 05/11/2012 916 OPPOSITION to ( 891 MOTION to Seal Portions of Hearing Transcript re 855 Transcript )

- Pursuant To General Order No. 59 filed by Apple Inc.. (Hung, Richard) (Filed on 5/11/2012) Modified text on 5/14/2012 (dhm, COURT STAFF). (Entered: 05/11/2012)
- 05/11/2012 917 Proposed Order Denying Samsung's Motion To Seal Portions Of Hearing Transcript (Dkt. No. 855) Pursuant To General Order No. 59 by Apple Inc.. (Hung, Richard) (Filed on 5/11/2012) (Entered: 05/11/2012)
- 05/13/2012 918 NOTICE of Translations of Foreign Authority by Samsung Electronics America, Inc.(a New York corporation), Samsung Electronics Co. Ltd., Samsung Telecommunications America, LLC(a Delaware limited liability company) (Attachments: # 1 Exhibit Exhibits 1-23, # 2 Exhibit Exhibits 24-62)(Maroulis, Victoria) (Filed on 5/13/2012) Modified text on 5/14/2012 (dhm, COURT STAFF). (Entered: 05/13/2012)
- 05/14/2012 919 CERTIFICATE OF SERVICE by Samsung Electronics America, Inc.(a New York corporation), Samsung Electronics Co. Ltd., Samsung Telecommunications America, LLC (a Delaware limited liability company) re 918 Notice (Other), Notice of Translations of Foreign Authority (Maroulis, Victoria) (Filed on 5/14/2012) (Entered: 05/14/2012)
- 05/14/2012 920 ORDER by Judge Lucy H. Koh granting in part and denying in part 405 Motion to Dismiss (lhkic2, COURT STAFF) (Filed on 5/14/2012) (Entered: 05/14/2012)
- 05/14/2012 921 OBJECTIONS to re 906 Declaration in Support, by Samsung Electronics America, Inc.(a New York corporation), Samsung Electronics Co. Ltd., Samsung Telecommunications America, LLC(a Delaware limited liability company). (Maroulis, Victoria) (Filed on 5/14/2012) (Entered: 05/14/2012)
- 05/15/2012 922 Administrative Motion to File Under Seal Samsung's Motion for Clarification Regarding the Court's May 4, 2012 Order filed by Samsung Electronics America, Inc.(a New York corporation), Samsung Electronics Co. Ltd., Samsung Telecommunications America, LLC (a Delaware limited liability company). (Attachments: # 1 Declaration of Joby Martin In Support of Samsung's Motion to File Documents Under Seal, # 2 Exhibit Samsung's Motion For Clarification Regarding the Court's May 4, 2012 Order (Redacted), # 3 Declaration of Mark Tung In Support of Samsung's Motion for Clarification (Redacted), # 4 Exhibit 1 to the Tung Declaration, # 5 Exhibit 2 to the Tung Declaration, # 6 Exhibit 3 to the Tung Declaration, # 7 Exhibit 4 to the Tung Declaration, # 8 Exhibit 5 to the Tung Declaration, # 9 Exhibit 6 to the Tung Declaration, # 10 Exhibit 7 to the Tung Declaration, # 11 Exhibit 8 to the Tung Declaration, # 12 Exhibit 9 to the Tung Declaration, # 13 Exhibit 10 to the Tung Declaration, # 14 Exhibit 11 to the Tung Declaration, # 15 Exhibit 12 to the Tung Declaration, # 16 Exhibit 13 to the Tung Declaration, # 17 Exhibit 14 to the Tung Declaration, # 18 Exhibit 15 to the Tung Declaration, # 19 Exhibit 16 to the Tung Declaration, # 20 Exhibit 17 to the Tung Declaration, # 21 Exhibit 18 to the Tung Declaration, # 22 Proposed Order Granting Samsung's Administrative Motion to File Documents Under Seal)(Maroulis, Victoria) (Filed on 5/15/2012) (Entered: 05/15/2012)
- 05/15/2012 923 Proposed Order Granting Samsung's Motion for Clarification Regarding the Court's May 4, 2012 Order by Samsung Electronics America, Inc.(a New York corporation), Samsung Electronics Co. Ltd., Samsung Telecommunications America, LLC(a Delaware limited liability company). (Maroulis, Victoria) (Filed on 5/15/2012) (Entered: 05/15/2012)
- 05/15/2012 924 CERTIFICATE OF SERVICE by Samsung Electronics America, Inc.(a New York corporation), Samsung Electronics Co. Ltd., Samsung Telecommunications America, LLC (a Delaware limited liability company) re 922 Administrative Motion to File Under Seal Samsung's Motion for Clarification Regarding the Court's May 4, 2012 Order (Maroulis, Victoria) (Filed on 5/15/2012) (Entered: 05/15/2012)
- 05/15/2012 -- Set/Reset Hearing re 922 Administrative Motion to File Under Seal Samsung's Motion for Clarification Regarding the Court's May 4, 2012 Order . Motion Hearing set for 6/19/2012 at 10:00 AM in Courtroom 5, 4th Floor, San Jose before Magistrate Judge Paul Singh Grewal. (ofr, COURT STAFF) (Filed on 5/15/2012) (Entered: 05/16/2012)
- 05/17/2012 925 Administrative Motion to File Under Seal Apple's Motion for Summary Judgment of Non-Infringement of U.S. Patent Number 7,362,867 and Invalidity of U.S. Patent Numbers 7,456,893 and 7,577,460 filed by Apple Inc.(a California corporation). (Attachments: # 1 Declaration of Erica Tierney in Support of Apple's Administrative Motion to File Documents Under Seal, # 2 Declaration of Mark D. Selwyn in Support of Apple's Administrative Motion to File Documents Under Seal, # 3 Proposed Order Granting Apple Inc.'s Administrative Motion to File Documents Under Seal, # 4 Plaintiff and Counterclaim-Defendant Apple Inc.'s Notice of Motion and Motion for Summary Judgment of Non-Infringement of U.S. Patent Number 7,362,867 and Invalidity of U.S. Patent Numbers 7,456,893 and 7,577,460, # 5 Declaration of Mark D. Selwyn in Support of Apple's Motion for Summary Judgment of Non-Infringement of U.S. Patent Number

7,362,867 and Invalidity of U.S. Patent Numbers 7,456,893 and 7,577,460, # 6 Exhibit 1, # 7 Exhibit 2, # 8 Exhibit 3, # 9 Exhibit 4, # 10 Exhibit 5, # 11 Exhibit 6, # 12 Exhibit 7, # 13 Exhibit 8, # 14 Exhibit 9, # 15 Exhibit 10, # 16 Exhibit 11, # 17 Exhibit 12, # 18 Exhibit 13, # 19 Exhibit 14, # 20 Exhibit 15, # 21 Exhibit 16, # 22 Exhibit 17, # 23 Exhibit 18, # 24 Exhibit 19, # 25 Exhibit 20, # 26 Exhibit 21, # 27 Exhibit 22, # 28 Exhibit 23, # 29 Exhibit 24, # 30 Exhibit 25, # 31 Exhibit 26, # 32 [Proposed] Order Granting Apple Inc.'s Motion for Partial Summary Judgment)(Selwyn, Mark) (Filed on 5/17/2012) Modified on 5/21/2012 attachment #1 and 2 sealed pursuant to General Order No. 62 (dhm, COURT STAFF). (Entered: 05/17/2012)

- 05/17/2012 926 CERTIFICATE OF SERVICE by Apple Inc.(a California corporation) re 925 Administrative Motion to File Under Seal Apple's Motion for Summary Judgment of Non-Infringement of U.S. Patent Number 7,362,867 and Invalidity of U.S. Patent Numbers 7,456,893 and 7,577,460 (Selwyn, Mark) (Filed on 5/17/2012) (Entered: 05/17/2012)
- 05/17/2012 927 Administrative Motion to File Under Seal Samsung's Motion to Exclude Opinions of Certain of Apple's Experts filed by Samsung Electronics America, Inc.(a New York corporation), Samsung Electronics Co. Ltd., Samsung Telecommunications America, LLC (a Delaware limited liability company). (Attachments: # 1 Samsung's Motion to Exclude Opinions of Certain of Apple's Experts, # 2 Declaration Declaration of Joby Martin In Support of Samsung's Motion to Exclude Opinions of Certain of Apple's Experts, # 3 Exhibit 1, # 4 Exhibit 2, # 5 Exhibit 3, # 6 Exhibit 4, # 7 Exhibit 5, # 8 Exhibit 6, # 9 Exhibit 7, # 10 Exhibit 8, # 11 Exhibit 9, # 12 Exhibit 10, # 13 Exhibit 11, # 14 Exhibit 12, # 15 Exhibit 13, # 16 Exhibit 14, # 17 Exhibit 15, # 18 Exhibit 16, # 19 Exhibit 17, # 20 Exhibit 18, # 21 Exhibit 19, # 22 Exhibit 20, # 23 Exhibit 21, # 24 Exhibit 22, # 25 Exhibit 23, # 26 Exhibit 24, # 27 Exhibit 25, # 28 Exhibit 26, # 29 Exhibit 27, # 30 Exhibit 28, # 31 Exhibit 29, # 32 Exhibit 30, # 33 Exhibit 31, # 34 Exhibit 32, # 35 Exhibit 33, # 36 Exhibit 34, # 37 Proposed Order Granting Samsung's Administrative Motion to File Documents Under Seal)(Maroulis, Victoria) (Filed on 5/17/2012) (Entered: 05/17/2012)
- 05/17/2012 928 Proposed Order re 927 ADMINISTRATIVE MOTION to File Documents Under Seal by Samsung Electronics America, Inc.(a New York corporation), Samsung Electronics Co. Ltd., Samsung Telecommunications America, LLC(a Delaware limited liability company). (Maroulis, Victoria) (Filed on 5/17/2012) Modified on 5/21/2012 linking entry to document #927 (dhm, COURT STAFF). (Entered: 05/17/2012)
- 05/17/2012 929 CERTIFICATE OF SERVICE by Samsung Electronics America, Inc.(a New York corporation), Samsung Electronics Co. Ltd., Samsung Telecommunications America, LLC (a Delaware limited liability company) re 927 Administrative Motion to File Under Seal Samsung's Motion to Exclude Opinions of Certain of Apple's Experts (Maroulis, Victoria) (Filed on 5/17/2012) (Entered: 05/17/2012)
- 05/17/2012 930 Administrative Motion to File Under Seal Samsung's Motion for Summary Judgment filed by Samsung Electronics Co. Ltd.. (Attachments: # 1 Motion for Summary Judgment, # 2 Proposed Order Granting Samsung's Motion for Summary Judgment, # 3 Trac Declaration in Support to Motion to File Under Seal, # 4 Proposed Order Granting Motion to File Under Seal)(Maroulis, Victoria) (Filed on 5/17/2012) Modified on 5/21/2012 attachment #3 Declaration Sealed pursuant to General Order No. 62 (dhm, COURT STAFF). (Entered: 05/17/2012)
- 05/17/2012 931 Declaration of Gray in Support of 930 Administrative Motion to File Under Seal Samsung's Motion for Summary Judgment filed by Samsung Electronics Co. Ltd.. (Attachments: # 1 Exhibit 1, # 2 Exhibit 2, # 3 Exhibit 3, # 4 Exhibit 4, # 5 Exhibit 5, # 6 Exhibit 6, # 7 Exhibit 7, # 8 Exhibit 8, # 9 Exhibit 9, # 10 Exhibit 10, # 11 Exhibit 11, # 12 Exhibit 12, # 13 Exhibit 13, # 14 Exhibit 14, # 15 Exhibit 15, # 16 Exhibit 16, # 17 Exhibit 17)(Related document(s) 930 ) (Maroulis, Victoria) (Filed on 5/17/2012) (Entered: 05/17/2012)
- 05/17/2012 932 Declaration in Support of 930 Administrative Motion to File Under Seal Samsung's Motion for Summary Judgment filed by Samsung Electronics Co. Ltd.. (Attachments: # 1 Exhibit A, # 2 Exhibit B, # 3 Exhibit C, # 4 Exhibit D, # 5 Exhibit E, # 6 Exhibit F, # 7 Exhibit G, # 8 Exhibit H, # 9 Exhibit I, # 10 Exhibit J)(Related document(s) 930 ) (Maroulis, Victoria) (Filed on 5/17/2012) (Entered: 05/17/2012)
- 05/17/2012 933 Declaration of Bogue in Support of 930 Administrative Motion to File Under Seal Samsung's Motion for Summary Judgment filed by Samsung Electronics Co. Ltd.. (Attachments: # 1 Exhibit 1, # 2 Exhibit 2, # 3 Exhibit 3, # 4 Exhibit 4, # 5 Exhibit 5) (Related document(s) 930 ) (Maroulis, Victoria) (Filed on 5/17/2012) (Entered: 05/17/2012)
- 05/17/2012 934 Administrative Motion to File Under Seal filed by Samsung Electronics America, Inc.(a

New York corporation), Samsung Electronics Co. Ltd., Samsung Telecommunications America, LLC(a Delaware limited liability company). (Attachments: # 1 Proposed Order Granting Motion to Seal, # 2 Declaration in Support of Motion to Seal, # 3 Exhibit 1 to Ward Declaration ISO Motion to Seal, # 4 Proposed Order Granting Motion to Strike, # 5 Declaration of Diane Hutnyan ISO Motion to Strike, # 6 Declaration of Jeffrey Johnson ISO Motion to Strike)(Maroulis, Victoria) (Filed on 5/17/2012) Modified on 5/21/2012 attachment #2 sealed pursuant to General Order No. 62 (dhm, COURT STAFF). (Entered: 05/17/2012)

05/17/2012 935 Declaration in Support of 934 Administrative Motion to File Under Seal filed by Samsung Electronics America, Inc.(a New York corporation), Samsung Electronics Co. Ltd., Samsung Telecommunications America, LLC(a Delaware limited liability company). (Attachments: # 1 Exhibit A, # 2 Exhibit B, # 3 Exhibit C, # 4 Exhibit D, # 5 Exhibit E, # 6 Exhibit F, # 7 Exhibit G, # 8 Exhibit H, # 9 Exhibit I, # 10 Exhibit J, # 11 Exhibit K, # 12 Exhibit L, # 13 Exhibit M, # 14 Exhibit N, # 15 Exhibit O, # 16 Exhibit P, # 17 Exhibit Q, # 18 Exhibit R, # 19 Exhibit S, # 20 Exhibit T, # 21 Exhibit U, # 22 Exhibit V, # 23 Exhibit W, # 24 Exhibit X)(Related document(s) 934 ) (Maroulis, Victoria) (Filed on 5/17/2012) (Entered: 05/18/2012)

05/17/2012 939 Administrative Motion to File Under Seal Apple's Administrative Motion to File Documents Under Seal filed by Apple Inc.. (Attachments: # 1 Apple's Motion to Strike Portions of Samsung's Expert Reports, # 2 Decl. of C. Wheeler, # 3 Decl. of E. Tierney, # 4 Decl. of M. Pernick, # 5 Ex. 1, # 6 Ex. 14, # 7 Ex. 15, # 8 Ex. 32, # 9 Ex. 33, # 10 Ex. 36, # 11 Ex. 37, # 12 Proposed Oder Granting Apple's Motion to Strike, # 13 Proposed Order Granting Apple's Admin Motion)(Tucher, Alison) (Filed on 5/17/2012) Modified on 5/21/2012 attachment #2 and #3 sealed pursuant to General Order No. 62 (dhm, COURT STAFF). (Entered: 05/18/2012)

05/18/2012 936 Declaration in Support of 934 Administrative Motion to File Under Seal filed by Samsung Electronics America, Inc.(a New York corporation), Samsung Electronics Co. Ltd., Samsung Telecommunications America, LLC(a Delaware limited liability company). (Attachments: # 1 Exhibit A, # 2 Exhibit B, # 3 Exhibit C, # 4 Exhibit D, # 5 Exhibit E, # 6 Exhibit F, # 7 Exhibit G, # 8 Exhibit H, # 9 Exhibit I, # 10 Exhibit J, # 11 Exhibit K, # 12 Exhibit L, # 13 Exhibit M, # 14 Exhibit N, # 15 Exhibit O, # 16 Exhibit P, # 17 Exhibit Q, # 18 Exhibit R, # 19 Exhibit S, # 20 Exhibit T, # 21 Exhibit U, # 22 Exhibit V, # 23 Exhibit W, # 24 Exhibit X, # 25 Exhibit Y, # 26 Exhibit Z, # 27 Exhibit AA, # 28 Exhibit BB, # 29 Exhibit CC, # 30 Exhibit DD, # 31 Exhibit EE, # 32 Exhibit FF, # 33 Exhibit GG) (Related document(s) 934 ) (Maroulis, Victoria) (Filed on 5/18/2012) (Entered: 05/18/2012)

05/18/2012 937 Declaration of Andries van Dam in Support of 930 Administrative Motion to File Under Seal Samsung's Motion for Summary Judgment filed by Samsung Electronics Co. Ltd.. (Attachments: # 1 Exhibit 1, # 2 Exhibit 2, # 3 Exhibit 3, # 4 Exhibit 4)(Related document(s) 930 ) (Maroulis, Victoria) (Filed on 5/18/2012) (Entered: 05/18/2012)

05/18/2012 938 Declaration of Clifton Forlines in Support of 930 Administrative Motion to File Under Seal Samsung's Motion for Summary Judgment filed by Samsung Electronics Co. Ltd.. (Related document(s) 930 ) (Maroulis, Victoria) (Filed on 5/18/2012) (Entered: 05/18/2012)

05/18/2012 940 Administrative Motion to File Under Seal Apple Inc.s Administrative Motion To File Documents Under Seal Re Apples Motion To Exclude Testimony Of Samsungs Experts filed by Apple Inc.. (Attachments: # 1 Apple Inc.s Notice Of Motion And Motion To Exclude Testimony Of Samsungs Experts, # 2 Declaration Of Jason Bartlett In Support Of Motion To Exclude Testimony Of Samsungs Experts, # 3 Exhibit 1, # 4 Exhibit 2, # 5 Exhibit 5, # 6 Exhibit 6, # 7 Exhibit 7, # 8 Exhibit 9, # 9 Exhibit 12, # 10 Exhibit 14, # 11 [Proposed] Order Granting Apples Motion To Exclude Testimony Of Samsungs Experts, # 12 Proposed Order Granting Apple's Admin Motion to File Under Seal) (McElhinny, Harold) (Filed on 5/18/2012) (Entered: 05/18/2012)

05/18/2012 941 EXHIBITS re 940 Administrative Motion to File Under Seal Apple Inc.s Administrative Motion To File Documents Under Seal Re Apples Motion To Exclude Testimony Of Samsungs Experts Exhibit 10 filed by Apple Inc.. (Related document(s) 940 ) (McElhinny, Harold) (Filed on 5/18/2012) (Entered: 05/18/2012)

05/18/2012 942 Declaration of Brian von Herzen in Support of 930 Administrative Motion to File Under Seal Samsung's Motion for Summary Judgment filed by Samsung Electronics Co. Ltd.. (Attachments: # 1 Exhibit 1, # 2 Exhibit 2, # 3 Exhibit 3, # 4 Exhibit 4, # 5 Exhibit 5, # 6 Exhibit 6, # 7 Exhibit 7, # 8 Exhibit 8, # 9 Exhibit 9, # 10 Exhibit 10, # 11 Exhibit 11, # 12 Exhibit 12, # 13 Exhibit 13, # 14 Exhibit 14, # 15 Exhibit 15, # 16 Exhibit 16, # 17 Exhibit 17, # 18 Exhibit 18, # 19 Exhibit 19, # 20 Exhibit 10)(Related document(s) 930 ) (Maroulis, Victoria) (Filed on 5/18/2012) (Entered: 05/18/2012)

- 05/18/2012 943 Declaration of Brett Arnold in Support of 930 Administrative Motion to File Under Seal Samsung's Motion for Summary Judgment filed by Samsung Electronics America, Inc., Samsung Electronics Co. Ltd., Samsung Telecommunications America, LLC. (Attachments: # 1 Ex. 4, # 2 Ex. 6, # 3 Ex. 7, # 4 Ex. 8, # 5 Ex. 9, # 6 Ex. 13, # 7 Ex. 16 (Part 1), # 8 Ex. 16 (Part 2), # 9 Ex. 16 (Part 3), # 10 Ex. 16 (Part 4))(Related document(s) 930 ) (Maroulis, Victoria) (Filed on 5/18/2012) (Entered: 05/18/2012)
- 05/18/2012 944 EXHIBITS re 943 Declaration in Support,, Ex. 17 (Part 1) filed by Samsung Electronics America, Inc., Samsung Electronics Co. Ltd., Samsung Telecommunications America, LLC. (Attachments: # 1 Ex. 17 (Part 2), # 2 Ex. 17 (Part 3), # 3 Ex. 17 (Part 4), # 4 Ex. 17 (Part 5), # 5 Ex. 17 (Part 6), # 6 Ex. 19, # 7 Ex. 21, # 8 Ex. 22, # 9 Ex. 24, # 10 Ex. 25, # 11 Ex. 26, # 12 Ex. 27, # 13 Ex. 28)(Related document(s) 943 ) (Maroulis, Victoria) (Filed on 5/18/2012) (Entered: 05/18/2012)
- 05/18/2012 945 EXHIBITS re 943 Declaration in Support,, Exhibits to Arnold Declaration (Exhibit 29) filed by Samsung Electronics America, Inc., Samsung Electronics Co. Ltd., Samsung Telecommunications America, LLC. (Attachments: # 1 Ex. 34, # 2 Ex. 35, # 3 Ex. 53, # 4 Ex. 62, # 5 Ex. 70, # 6 Ex. 83)(Related document(s) 943 ) (Maroulis, Victoria) (Filed on 5/18/2012) (Entered: 05/18/2012)
- 05/18/2012 946 EXHIBITS re 943 Declaration in Support,, Exhibits to Arnold Declaration (Ex. 84 (Part 1)) filed by Samsung Electronics America, Inc., Samsung Electronics Co. Ltd., Samsung Telecommunications America, LLC. (Attachments: # 1 Ex. 84 (Part 2), # 2 Ex. 84 (Part 3), # 3 Ex. 84 (Part 4), # 4 Ex. 84 (Part 5), # 5 Ex. 85 (Part 1), # 6 Ex. 85 (Part 2), # 7 Ex. 85 (Part 3), # 8 Ex. 86 (Part 1), # 9 Ex. 86 (Part 2), # 10 Ex. 86 (Part 3), # 11 Ex. 86 (Part 4))(Related document(s) 943 ) (Maroulis, Victoria) (Filed on 5/18/2012) (Entered: 05/18/2012)
- 05/18/2012 947 CERTIFICATE OF SERVICE by Apple Inc. (Tucher, Alison) (Filed on 5/18/2012) (Entered: 05/18/2012)
- 05/18/2012 948 CERTIFICATE OF SERVICE by Samsung Electronics Co. Ltd. re 930 Administrative Motion to File Under Seal Samsung's Motion for Summary Judgment (Maroulis, Victoria) (Filed on 5/18/2012) (Entered: 05/18/2012)
- 05/18/2012 949 CERTIFICATE OF SERVICE by Apple Inc. (Tucher, Alison) (Filed on 5/18/2012) (Entered: 05/18/2012)
- 05/18/2012 950 REPLY (re 891 MOTION to Seal Portions of Hearing Transcript re 855 Transcript,, ) filed by Samsung Electronics America, Inc.(a New York corporation), Samsung Electronics Co. Ltd., Samsung Telecommunications America, LLC(a Delaware limited liability company). (Maroulis, Victoria) (Filed on 5/18/2012) (Entered: 05/18/2012)
- 05/18/2012 951 MOTION for Preliminary Injunction Apple Inc.s Motion Pursuant To Rule 62(C) For Entry Of Preliminary Injunction Without Further Hearing filed by Apple Inc.. Responses due by 5/25/2012. Replies due by 5/30/2012. (Attachments: # 1 Appendix 1, # 2 Proposed Order [Proposed] Preliminary Injunction)(McElhinny, Harold) (Filed on 5/18/2012) (Entered: 05/18/2012)
- 05/18/2012 952 MOTION to Shorten Time Apples Inc.s Motion To Shorten Time For Briefing On Apple Inc.s Motion Pursuant To Rule 62(C) For Entry Of Preliminary Injunction Without Further Hearing filed by Apple Inc.. (Attachments: # 1 Declaration Of Mia Mazza In Support Of Apple Inc.s Motion To Shorten Time For Briefing On Its Motion Pursuant To Rule 62(C) For Entry Of Preliminary Injunction Without Further Hearing, # 2 Proposed Order [Proposed] Order Granting Apples Motion To Shorten Time For Briefing On APPLE Inc.s Motion Pursuant To Rule 62(C) For Entry Of Preliminary Injunction Without Further Hearing)(McElhinny, Harold) (Filed on 5/18/2012) (Entered: 05/18/2012)
- 05/18/2012 953 Administrative Motion to File Under Seal filed by Samsung Electronics America, Inc.(a New York corporation), Samsung Electronics Co. Ltd., Samsung Telecommunications America, LLC(a Delaware limited liability company). (Attachments: # 1 Samsung's Conditional Motion for Relief From Nondispositive Pretrial Order of Magistrate Judge, # 2 Declaration of Mark Tung, # 3 Exhibit 1, # 4 Exhibit 2, # 5 Exhibit 10, # 6 Proposed Order Granting Samsung's Administrative Motion to File Documents Under Seal) (Maroulis, Victoria) (Filed on 5/18/2012) (Entered: 05/18/2012)
- 05/18/2012 954 Proposed Order re 953 Administrative Motion to File Under Seal by Samsung Electronics America, Inc.(a New York corporation), Samsung Electronics Co. Ltd., Samsung Telecommunications America, LLC(a Delaware limited liability company). (Maroulis, Victoria) (Filed on 5/18/2012) (Entered: 05/18/2012)
- 05/18/2012 955 CERTIFICATE OF SERVICE by Samsung Electronics America, Inc.(a New York corporation), Samsung Electronics Co. Ltd., Samsung Telecommunications America, LLC

- (a Delaware limited liability company) re 953 Administrative Motion to File Under Seal (Maroulis, Victoria) (Filed on 5/18/2012) (Entered: 05/18/2012)
- 05/21/2012 956 OPPOSITION to ( 952 MOTION to Shorten Time For Briefing On Apple Inc.s Motion Pursuant To Rule 62(C) For Entry Of Preliminary Injunction Without Further Hearing ) filed by Samsung Electronics Co. Ltd.. (Maroulis, Victoria) (Filed on 5/21/2012) Modified text on 5/22/2012 (dhm, COURT STAFF). (Entered: 05/21/2012)
- 05/21/2012 957 Proposed Order [Corrected] Granting Samsung's Motion for Summary Judgment [930-1] by Samsung Electronics Co. Ltd.. (Maroulis, Victoria) (Filed on 5/21/2012) Modified text on 5/22/2012 (dhm, COURT STAFF). (Entered: 05/21/2012)
- 05/21/2012 958 Statement Statement Regarding Potential Impact Of Motions On Scope Of Trial by Apple Inc.. (McElhinny, Harold) (Filed on 5/21/2012) (Entered: 05/21/2012)
- 05/21/2012 959 Statement Regarding the Impact of Samsung's Case Narrowing Motions by Samsung Electronics Co. Ltd.. (Maroulis, Victoria) (Filed on 5/21/2012) (Entered: 05/21/2012)
- 05/21/2012 960 REPLY (re 952 MOTION to Shorten Time Apples Inc.s Motion To Shorten Time For Briefing On Apple Inc.s Motion Pursuant To Rule 62(C) For Entry Of Preliminary Injunction Without Further Hearing ) Apple Inc.s Reply In Support Of Its Motion To Shorten Time For Briefing On Apple Inc.s Motion Pursuant To Rule 62(C) For Entry Of Preliminary Injunction Without Further Hearing filed by Apple Inc.. (McElhinny, Harold) (Filed on 5/21/2012) (Entered: 05/21/2012)
- 05/21/2012 961 STIPULATION WITH PROPOSED ORDER Joint Stipulation And [Proposed] Order Dismissing Claims Without Prejudice filed by Apple Inc.. (McElhinny, Harold) (Filed on 5/21/2012) (Entered: 05/21/2012)
- 05/21/2012 962 ORDER by Judge Lucy H. Koh granting 952 Motion to Shorten Time (lhkic2, COURT STAFF) (Filed on 5/21/2012) (Entered: 05/21/2012)
- 05/22/2012 963 PLEASE DISREGARD. WRONG DOCUMENT ATTACHED. SEE NEXT ENTRY Minute Entry: Settlement Conference held on 5/21/12 before Magistrate Judge Joseph C. Spero. Continued Settlement Conference set for 5/22/12 at 9:30 AM. (Court Reporter Not Reported.) (klhS, COURT STAFF) (Date Filed: 5/22/2012) Modified on 5/22/2012 (klhS, COURT STAFF). (Entered: 05/22/2012)
- 05/22/2012 964 Minute Entry: Settlement Conference held on 5/21/12 before Mag. Judge Joseph C. Spero. Continued settlement conference set for 5/22/12 at 9:30 AM. (Court Reporter Not Reported.) (klhS, COURT STAFF) (Date Filed: 5/22/2012) Modified text on 5/23/2012 (dhm, COURT STAFF). (Entered: 05/22/2012)
- 05/22/2012 -- Set/Reset Hearing re 939 Administrative Motion to File Under Seal Apple's Administrative Motion to File Documents Under Seal Motion Hearing set for 6/26/2012 at 10:00 AM in Courtroom 5, 4th Floor, San Jose before Magistrate Judge Paul Singh Grewal. (ofr, COURT STAFF) (Filed on 5/22/2012) (Entered: 05/22/2012)
- 05/22/2012 965 Administrative Motion to File Under Seal Samsung's Motion to Enforce April 12, 2012 Order filed by Samsung Electronics America, Inc.(a New York corporation), Samsung Electronics Co. Ltd., Samsung Telecommunications America, LLC(a Delaware limited liability company). (Attachments: # 1 Samsung's Motion to Enforce April 12, 2012 Order (Public Redacted Version), # 2 Declaration of Diane C. Hutnyan In Support of Samsung's Motion to Enforce April 12, 2012 Order, # 3 Exhibit 1, # 4 Exhibit 2, # 5 Exhibit 3, # 6 Exhibit 4, # 7 Exhibit 5, # 8 Exhibit 6, # 9 Exhibit 7, # 10 Exhibit 8, # 11 Exhibit 9, # 12 Exhibit 10, # 13 Exhibit 11, # 14 Proposed Order Granting Samsung's Motion to Enforce April 12, 2012 Order)(Maroulis, Victoria) (Filed on 5/22/2012) (Entered: 05/22/2012)
- 05/22/2012 966 CERTIFICATE OF SERVICE by Samsung Electronics America, Inc.(a New York corporation), Samsung Electronics Co. Ltd., Samsung Telecommunications America, LLC (a Delaware limited liability company) re 965 Administrative Motion to File Under Seal Samsung's Motion to Enforce April 12, 2012 Order (Maroulis, Victoria) (Filed on 5/22/2012) (Entered: 05/22/2012)
- 05/22/2012 967 NOTICE OF MOTION for Clarification of April 12 Order by Apple Inc. re 888 Proposed Order, 887 Declaration in Support,, 894 Reply to Opposition/Response, 903 Status Report, 904 Exhibits, 885 MOTION Administrative Relief . Motion hearing set for 6/26/2012 at 10:00 AM before Magistrate Judge Paul S. Grewal (Tucher, Alison) (Filed on 5/22/2012) Modified on 6/6/2012 counsel incorreced posted document as a notice (dhm, COURT STAFF). (Entered: 05/22/2012)
- 05/22/2012 968 MOTION for Sanctions filed by Samsung Electronics America, Inc.(a New York corporation), Samsung Electronics Co. Ltd., Samsung Telecommunications America, LLC (a Delaware limited liability company). Motion Hearing set for 6/26/2012 10:00 AM in

Courtroom 5, 4th Floor, San Jose before Magistrate Judge Paul Singh Grewal. Responses due by 6/5/2012. Replies due by 6/12/2012. (Attachments: # 1 Declaration of Diane C. Hutnyan in Support of Motion for Rule 37 Sanctions, # 2 Proposed Order Granting Samsung's Motion for Rule 37 Sanctions)(Maroulis, Victoria) (Filed on 5/22/2012) (Entered: 05/22/2012)

- 05/22/2012 -- Set/Reset Hearing re 967 Notice (Other): Motion Hearing (In Re: Docket No. 885 ) set for 6/26/2012 at 10:00 AM in Courtroom 5, 4th Floor, San Jose before Magistrate Judge Paul Singh Grewal. (ofr, COURT STAFF) (Filed on 5/22/2012) (Entered: 05/25/2012)
- 05/22/2012 -- Set/Reset Hearing re 965 Administrative Motion to File Under Seal Samsung's Motion to Enforce April 12, 2012 Order Motion Hearing set for 6/26/2012 at 10:00 AM in Courtroom 5, 4th Floor, San Jose before Magistrate Judge Paul Singh Grewal. (ofr, COURT STAFF) (Filed on 5/22/2012) (Entered: 05/29/2012)
- 05/23/2012 969 Minute Entry: Further Settlement Conference held on 5/22/12 before Magistrate Judge Joseph C. Spero. (Court Reporter Not Reported.) (klhS, COURT STAFF) (Date Filed: 5/23/2012) (Entered: 05/23/2012)
- 05/24/2012 970 ORDER. Signed by Judge Joseph C. Spero on 5/23/12. \*\*\*FILED UNDER SEAL\*\*\* (klh, COURT STAFF) (Filed on 5/24/2012) (Entered: 05/24/2012)
- 05/24/2012 971 NOTICE of Authority Regarding 895 Administrative Motion to File Under Seal by Samsung Electronics America, Inc.(a New York corporation), Samsung Electronics Co. Ltd., Samsung Telecommunications America, LLC(a Delaware limited liability company) (Attachments: # 1 Exhibit A)(Maroulis, Victoria) (Filed on 5/24/2012) Modified text on 5/25/2012 (dhm, COURT STAFF). (Entered: 05/24/2012)
- 05/24/2012 972 Declaration of Cyndi Wheeler in Support of 927 Administrative Motion to File Under Seal Samsung's Motion to Exclude Opinions of Certain of Apple's Experts filed by Apple Inc.. (Attachments: # 1 Exhibit 1, # 2 Exhibit 2, # 3 Exhibit 3, # 4 Exhibit 4, # 5 Declaration Of Mark D. Selwyn In Support Of Samsungs Administrative Motion To File Documents Under Seal Re Samsungs Motion To Exclude Opinions Of Certain Apple Experts, # 6 Selwyn Exhibit 1, # 7 Proposed Order [Proposed] Order Granting Samsungs Administrative Motion To File Documents Under Seal Re Samsungs Motion To Exclude Opinions Of Certain Apple Experts)(Related document(s) 927 ) (Bartlett, Jason) (Filed on 5/24/2012) (Entered: 05/24/2012)
- 05/24/2012 973 Declaration of Cyndi Wheeler in Support of 930 Administrative Motion to File Under Seal Samsung's Motion for Summary Judgment filed by Apple Inc.. (Attachments: # 1 Exhibit 1, # 2 Exhibit 2, # 3 Exhibit 3, # 4 Exhibit 4, # 5 Exhibit 5, # 6 Exhibit 6, # 7 Exhibit 7, # 8 Exhibit 8, # 9 Exhibit 9, # 10 Exhibit 10, # 11 Exhibit 11, # 12 Exhibit 12, # 13 Exhibit 13, # 14 Exhibit 14, # 15 Exhibit 15, # 16 Exhibit 16, # 17 Exhibit 17, # 18 Declaration Of Mark D. Selwyn In Support Of Samsungs Administrative Motion To File Documents Under Seal Re Samsungs Motion For Summary Judgment, # 19 Proposed Order [Proposed] Order Granting Samsungs Administrative Motion To File Documents Under Seal Re Samsungs Motion For Summary Judgment)(Related document(s) 930 ) (Bartlett, Jason) (Filed on 5/24/2012) (Entered: 05/24/2012)
- 05/24/2012 974 Declaration of Cyndi Wheeler in Support of 934 Administrative Motion to File Under Seal Re Samsungs Motion To Strike Expert Testimony filed by Apple Inc.. (Attachments: # 1 Exhibit 1, # 2 Exhibit 2, # 3 Exhibit 3, # 4 Exhibit 4, # 5 Exhibit 5, # 6 Exhibit 6, # 7 Exhibit 7, # 8 Exhibit 8, # 9 Exhibit 9, # 10 Exhibit 10, # 11 Exhibit 11, # 12 Exhibit 12, # 13 Declaration Of Mark D. Selwyn In Support Of Samsungs Administrative Motion To File Documents Under Seal Re Samsungs Motion To Strike Expert Testimony, # 14 Selwyn Decl. Ex. 1, # 15 Selwyn Decl. Ex. 2, # 16 Proposed Order [Proposed] Order Granting Samsungs Administrative Motion To File Documents Under Seal Re Samsungs Motion To Strike Expert Testimony)(Related document(s) 934 ) (Bartlett, Jason) (Filed on 5/24/2012) (Entered: 05/24/2012)
- 05/24/2012 975 Declaration of Joby Martin in Support of 939 Administrative Motion to File Under Seal Apple's Administrative Motion to File Documents Under Seal filed by Samsung Electronics America, Inc.(a New York corporation), Samsung Electronics Co. Ltd., Samsung Telecommunications America, LLC(a Delaware limited liability company). (Attachments: # 1 Proposed Order Granting Apple's Motion to File Documents Under Seal)(Related document(s) 939 ) (Maroulis, Victoria) (Filed on 5/24/2012) (Entered: 05/24/2012)
- 05/24/2012 976 Declaration of Joby Martin in Support of 940 Administrative Motion to File Under Seal Apple Inc.s Administrative Motion To File Documents Under Seal Re Apples Motion To Exclude Testimony Of Samsungs Experts filed by Samsung Electronics America, Inc.(a New York corporation), Samsung Electronics Co. Ltd., Samsung Telecommunications America, LLC(a Delaware limited liability company). (Attachments: # 1 Proposed Order

- Granting Apple's Administrative Motion to File Documents Under Seal)(Related document (s) 940 ) (Maroulis, Victoria) (Filed on 5/24/2012) (Entered: 05/24/2012)
- 05/25/2012 977 \*\*\* ATTACHMENTS 2 and 3 FILED IN ERROR WITH CONFIDENTIAL INFORMATION. DOCUMENT LOCKED. \*\*\* Administrative Motion to File Under Seal filed by Samsung Electronics America, Inc.(a New York corporation), Samsung Electronics Co. Ltd., Samsung Telecommunications America, LLC(a Delaware limited liability company). (Attachments: # 1 Proposed Order Granting Administrative Motion to File Under Seal, # 2 Declaration of Hankil Kang in Support of Administrative Motion to File Under Seal, # 3 Samsung's Opposition to Apple's Rule 62(C) Motion, # 4 Declaration of Paul Chapple in Support of Samsung's Opposition, # 5 Declaration of Travis Merrill in Support of Samsung's Opposition, # 6 Declaration of Carl Anderson in Support of Samsung's Opposition, # 7 Exhibit 1 to the Declaration of Carl Anderson, # 8 Exhibit 2 to the Declaration of Carl Anderson, # 9 Exhibit 3 to the Declaration of Carl Anderson, # 10 Exhibit 4 to the Declaration of Carl Anderson, # 11 Proposed Order Denying Apple's Rule 62(C) Motion)(Maroulis, Victoria) (Filed on 5/25/2012) Modified on 5/29/2012 Attachment #2 Sealed pursuant to General Order No. 62 (dhm, COURT STAFF). Modified on 6/5/2012 (fff, COURT STAFF). (Entered: 05/25/2012)
- 05/26/2012 978 Administrative Motion to File Under Seal filed by Samsung Electronics America, Inc.(a New York corporation), Samsung Electronics Co. Ltd., Samsung Telecommunications America, LLC(a Delaware limited liability company). (Attachments: # 1 Samsung's Motion For Leave To Seek Reconsideration of the Court's May 21, 2012 Order, # 2 Declaration of Thomas Watson, # 3 Exhibit 4, # 4 Exhibit 17, # 5 Exhibit 18, # 6 Exhibit 19, # 7 Proposed Order Granting Samsung's Motion for Leave, # 8 Proposed Order Granting Samsung's Administrative Motion to File Documents Under Seal)(Maroulis, Victoria) (Filed on 5/26/2012) (Entered: 05/26/2012)
- 05/26/2012 979 CERTIFICATE OF SERVICE by Samsung Electronics America, Inc.(a New York corporation), Samsung Electronics Co. Ltd., Samsung Telecommunications America, LLC (a Delaware limited liability company) re 978 Administrative Motion to File Under Seal (Maroulis, Victoria) (Filed on 5/26/2012) (Entered: 05/26/2012)
- 05/26/2012 980 CERTIFICATE OF SERVICE by Samsung Electronics America, Inc.(a New York corporation), Samsung Electronics Co. Ltd., Samsung Telecommunications America, LLC (a Delaware limited liability company) re 977 Administrative Motion to File Under Seal (Maroulis, Victoria) (Filed on 5/26/2012) (Entered: 05/26/2012)
- 05/29/2012 981 ORDER by Judge Lucy H. Koh granting 961 Stipulation (lhkic2, COURT STAFF) (Filed on 5/29/2012) (Entered: 05/29/2012)
- 05/29/2012 982 Declaration of Cyndi Wheeler in Support of 965 Administrative Motion to File Under Seal Samsung's Motion to Enforce April 12, 2012 Order filed by Apple Inc.(a California corporation). (Attachments: # 1 Exhibit One, # 2 Proposed Order)(Related document(s) 965 ) (Bartlett, Jason) (Filed on 5/29/2012) (Entered: 05/29/2012)
- 05/29/2012 -- Set/Reset Hearing Apple Motion for Preliminary Injunction Pursuant to Rule 62(c) Motion Hearing set for 6/7/2012 01:30 PM in Courtroom 8, 4th Floor, San Jose before Hon. Lucy H. Koh. (lhkic2, COURT STAFF) (Filed on 5/29/2012) (Entered: 05/29/2012)
- 05/29/2012 983 ANSWER to 381 Counterclaim by Samsung Electronics America, Inc.(a New York corporation), Samsung Electronics Co. Ltd.(a Korean corporation), Samsung Telecommunications America, LLC(a Delaware limited liability company). (Maroulis, Victoria) (Filed on 5/29/2012) Modified text on 5/30/2012 (dhm, COURT STAFF). (Entered: 05/29/2012)
- 05/29/2012 984 Administrative Motion to File Under Seal filed by Samsung Electronics America, Inc.(a New York corporation), Samsung Electronics Co. Ltd., Samsung Telecommunications America, LLC(a Delaware limited liability company). (Attachments: # 1 Declaration of Christopher Price in Support of Samsung's Administrative Motion to Seal, # 2 Proposed Order Granting Samsung's Administrative Motion to Seal, # 3 Exhibit 1 to Declaration of Christopher Price in Support of Motion to Seal (Supplemental Price Declaration), # 4 Exhibit 1 to Supplemental Price Declaration (Filed Under Seal), # 5 Exhibit 2 to Supplemental Price Declaration (Filed Under Seal), # 6 Exhibit 3 to Supplemental Price Declaration (Filed Under Seal), # 7 Exhibit 4 to Supplemental Price Declaration (Filed Under Seal), # 8 Exhibit 5 to Supplemental Price Declaration (Filed Under Seal)) (Maroulis, Victoria) (Filed on 5/29/2012) (Entered: 05/29/2012)
- 05/29/2012 985 OPPOSITION to ( 922 Administrative Motion to File Under Seal Samsung's Motion for Clarification Regarding the Court's May 4, 2012 Order ) filed by Apple Inc.. (Attachments: # 1 Proposed Order)(Jacobs, Michael) (Filed on 5/29/2012) Modified text on 5/30/2012 (dhm, COURT STAFF). (Entered: 05/29/2012)



- 05/29/2012 986 Administrative Motion to File Under Seal filed by Apple Inc.. (Attachments: # 1 Proposed Order, # 2 Declaration of Marc J. Pernick in Support of Apple's Opposition to Samsung's Motion for Clarification Regarding the Court's May 4, 2012 Order, # 3 Exhibit A (under seal), # 4 Exhibit B, # 5 Exhibit C, # 6 Exhibit D)(Jacobs, Michael) (Filed on 5/29/2012) (Entered: 05/29/2012)
- 05/29/2012 987 Administrative Motion to File Under Seal filed by Samsung Electronics America, Inc.(a New York corporation), Samsung Electronics Co. Ltd., Samsung Telecommunications America, LLC(a Delaware limited liability company). (Attachments: # 1 Proposed Order Granting Motion to Seal, # 2 Declaration of Daniel Shim in Support of Motion to Seal, # 3 Samsung's Opposition to Apple's Motion for Adverse Inference Jury Instructions, # 4 Declaration of Thomas Watson, # 5 Exhibit 1 to Watson, # 6 Exhibit 2 to Watson, # 7 Exhibit 3 to Watson, # 8 Exhibit 4 to Watson, # 9 Exhibit 5 to Watson, # 10 Exhibit 6 to Watson, # 11 Exhibit 7 to Watson, # 12 Exhibit 8 to Watson, # 13 Exhibit 9 to Watson, # 14 Exhibit 10 to Watson, # 15 Exhibit 11 to Watson, # 16 Exhibit 12 to Watson, # 17 Exhibit 13 to Watson, # 18 Exhibit 14 to Watson, # 19 Exhibit 15 to Watson, # 20 Exhibit 16 to Watson, # 21 Exhibit 17 to Watson, # 22 Exhibit 18 to Watson, # 23 Exhibit 19 to Watson, # 24 Exhibit 20 to Watson, # 25 Exhibit 21 to Watson, # 26 Exhibit 22 to Watson, # 27 Exhibit 23 to Watson, # 28 Exhibit 24 to Watson, # 29 Exhibit 25 to Watson, # 30 Exhibit 26 to Watson, # 31 Exhibit 27 to Watson, # 32 Exhibit 28 to Watson, # 33 Exhibit 29 to Watson, # 34 Exhibit 30 to Watson, # 35 Exhibit 31 to Watson, # 36 Exhibit 32 to Watson, # 37 Exhibit 33 to Watson, # 38 Declaration of Sara Jenkins, # 39 Declaration of Alex Binder, # 40 Exhibit 1 to Binder, # 41 Exhibit 2 to Binder, # 42 Exhibit 3 to Binder, # 43 Exhibit 4 to Binder, # 44 Declaration of Hankil Kang, # 45 Declaration of Don Joo Lee, # 46 Declaration of Giho Ro, # 47 Declaration of Han-Yeol Ryu, # 48 Declaration of Heontae Son, # 49 Declaration of Ioi Lam, # 50 Declaration of Jong Dae Park, # 51 Declaration of Joo Hyuk Kang, # 52 Declaration of Kang Hyun Lee, # 53 Declaration of Min Cheol Shin, # 54 Declaration of Minhyouk Lee, # 55 Declaration of Nara Cho, # 56 Declaration of Se-Hyun Cho, # 57 Declaration of Sungsik Lee, # 58 Declaration of Won Pyo Hong, # 59 Declaration of Wooup Kwon, # 60 Declaration of Young-jo Lim, # 61 Declaration of YoungSoon Lee, # 62 Declaration of Kyu Hyuk Lee, # 63 Declaration of Michael Finnegan, # 64 Declaration of Byungil Kim, # 65 Declaration of M. James Daley, # 66 Declaration of Raymond Warren, # 67 Proposed Order Denying Apple's Motion for Adverse Inference Jury Instructions)(Maroulis, Victoria) (Filed on 5/29/2012) (Entered: 05/29/2012)
- 05/30/2012 988 CLERK'S NOTICE RESETTING TIME ON 6/5/2012 MOTION TO SEAL: 6/5/2012 10:00 AM Motion to Seal (In Re: Docket No. 891 ) reset to 09:00 AM in Courtroom 5, 4th Floor, San Jose before Magistrate Judge Paul Singh Grewal. \*\*\*This is a text only docket entry, there is no document associated with this notice.\*\*\* (ofr, COURT STAFF) (Filed on 5/30/2012) (Entered: 05/30/2012)
- 05/30/2012 989 CERTIFICATE OF SERVICE by Samsung Electronics America, Inc.(a New York corporation), Samsung Electronics Co. Ltd., Samsung Telecommunications America, LLC (a Delaware limited liability company) re 987 Administrative Motion to File Under Seal (Maroulis, Victoria) (Filed on 5/30/2012) (Entered: 05/30/2012)
- 05/30/2012 990 Administrative Motion to File Under Seal Corrected Supplemental Price Declaration filed by Samsung Electronics America, Inc.(a New York corporation), Samsung Electronics Co. Ltd., Samsung Telecommunications America, LLC(a Delaware limited liability company). (Attachments: # 1 Declaration of Christopher Price In Support of Motion to Seal, # 2 Proposed Order Granting Samsung's Administrative Motion to Seal, # 3 Exhibit 1 to Price Declaration in Support of Motion to Seal (Corrected Supplemental Price Declaration), # 4 Exhibit 1 to Corrected Supplemental Price Declaration - Filed Under Seal, # 5 Exhibit 2 to Corrected Supplemental Price Declaration - Filed Under Seal, # 6 Exhibit 3 to Corrected Supplemental Price Declaration - Filed Under Seal, # 7 Exhibit 4 to Corrected Supplemental Price Declaration - Filed Under Seal, # 8 Exhibit 5 to Corrected Supplemental Price Declaration - Filed Under Seal)(Maroulis, Victoria) (Filed on 5/30/2012) Modified on 5/31/2012 Attachment #1 Sealed Pursuant to General Order No. 62 (dhm, COURT STAFF). (Entered: 05/30/2012)
- 05/31/2012 991 Administrative Motion to File Under Seal Documents Re Apples Opposition To Samsungs Motion To Exclude Opinions Of Certain Of Apple Experts filed by Apple Inc.. (Attachments: # 1 Declaration Of Cyndi Wheeler In Support Of Apples Administrative Motion To File Under Seal Documents Re Apples Opposition to Exclude Apple Experts Opinions, # 2 [Proposed] Order Granting Apples Administrative Motion To File Under Seal, # 3 Apples Opposition To Samsungs Motion To Exclude Opinions Of Certain Of Apples Experts, # 4 Declaration Of Mia Mazza In Support Of Apples Opposition To Samsungs Motion To Exclude Opinions Of Certain Of Apples Experts, # 5 Exhibit Mazza

Decl. Ex. D, # 6 Exhibit Mazza Decl. Ex. F, # 7 Exhibit Mazza Decl. Ex. G, # 8 Exhibit Mazza Decl. Ex. J, # 9 Exhibit Mazza Decl. Ex. K, # 10 Exhibit Mazza Decl. Ex. L, # 11 Exhibit Mazza Decl. Ex. R, # 12 Exhibit Mazza Decl. Ex. S, # 13 Exhibit Mazza Decl. Ex. T, # 14 Exhibit Mazza Decl. Ex. U, # 15 Exhibit Mazza Decl. Ex. V, # 16 Exhibit Hauser Decl. Ex. B, # 17 Exhibit Hauser Decl. Ex. C, # 18 Exhibit Hauser Decl. Ex. D, # 19 Exhibit Hauser Decl. Ex. E, # 20 Exhibit Musika Decl. Ex. S, # 21 Exhibit Musika Decl. Ex. T, # 22 Exhibit Musika Decl. Ex. U, # 23 [Proposed] Order Denying Samsungs Motion To Exclude Opinions Of Apples Experts)(Jacobs, Michael) (Filed on 5/31/2012) Modified on 6/3/2012 attachment #1 Sealed pursuant to General Order No. 62 (dhm, COURT STAFF). (Entered: 05/31/2012)

05/31/2012 992 Declaration of Mark D. Selwyn in Support of 991 Administrative Motion to File Under Seal Documents Re Apples Opposition To Samsungs Motion To Exclude Opinions Of Certain Of Apple Experts filed by Apple Inc.(a California corporation). (Related document(s) 991 ) (Selwyn, Mark) (Filed on 5/31/2012) (Entered: 05/31/2012)

05/31/2012 993 Administrative Motion to File Under Seal filed by Apple Inc.. (Attachments: # 1 [Proposed] Order Granting Administrative Motion To File Documents Under Seal, # 2 Apple Inc.s Reply In Support Of Motion Pursuant To Rule 62(C) For Entry Of Preliminary Injunction Without Further Hearing, # 3 [Proposed] Findings Of Fact And Conclusions Of Law And Order Granting Preliminary Injunction)(Jacobs, Michael) (Filed on 5/31/2012) (Entered: 05/31/2012)

05/31/2012 994 Administrative Motion to File Under Seal Second Supplemental Price Declaration in Support of (Dkt No. 934) Samsung's Motion to Strike filed by Samsung Electronics Co. Ltd.. (Attachments: # 1 Price Declaration in Support of Motion to Seal, # 2 Proposed Order Granting Motion to Seal, # 3 Second Supplemental Price Declaration, # 4 Exhibit A, # 5 Exhibit B, # 6 Exhibit C, # 7 Exhibit D, # 8 Exhibit E)(Maroulis, Victoria) (Filed on 5/31/2012) Modified on 6/3/2012 attachment #1 Sealed pursuant to General Order No. 62 (dhm, COURT STAFF). (Entered: 05/31/2012)

05/31/2012 995 CERTIFICATE OF SERVICE by Samsung Electronics Co. Ltd. re 994 Administrative Motion to File Under Seal Second Supplemental Price Declaration in Support of (Dkt No. 934) Samsung's Motion to Strike (Maroulis, Victoria) (Filed on 5/31/2012) (Entered: 05/31/2012)

05/31/2012 996 Administrative Motion to File Under Seal Documents Under Seal Re Apples Opposition To Samsungs Motion To Strike Expert Testimony filed by Apple Inc.. (Attachments: # 1 Declaration Of Cyndi Wheeler In Support Of Apples Administrative Motion To File Under Seal Documents Re Apples Opposition To Samsungs Motion To Strike Expert Testimony, # 2 Declaration Of Mia Mazza In Support Of Apples Administrative Motion To File Documents Under Seal Re Apples Opposition To Samsungs Motion To Strike Expert Testimony, # 3 [Proposed] Order Granting Apples Administrative Motion To File Documents Under Seal Re Apples Opposition To Samsungs Motion To Strike, # 4 Apples Opposition To Samsungs Motion To Strike Expert Testimony Based On Undisclosed Facts And Theories, # 5 Declaration Of Marc J. Pernick In Support Of Apples Opposition To Samsungs Motion To Strike Expert Testimony Based On Undisclosed Facts And Theories, # 6 Exhibit Pernick Decl. Ex. 8, # 7 Exhibit Pernick Decl. Ex. 10, # 8 Exhibit Pernick Decl. Ex. 11, # 9 Exhibit Pernick Decl. Ex. 12, # 10 Exhibit Pernick Decl. Ex. 16, # 11 Exhibit Pernick Decl. Ex. 17, # 12 Exhibit Pernick Decl. Ex. 19, # 13 Declaration Of Michel Maharbiz, Ph.D. In Support Of Apples Opposition To Samsungs Motion To Strike Expert Testimony, # 14 Exhibit Maharbiz Decl. Ex. A, # 15 Exhibit Maharbiz Decl. Ex. B, # 16 [Proposed] Order Denying Samsungs Motion To Strike Expert Testimony (Dkt. No. 936)) (Jacobs, Michael) (Filed on 5/31/2012) Modified on 6/3/2012 pursuant to General Order No. 62, attachment #1 and #2 Sealed (dhm, COURT STAFF). (Entered: 05/31/2012)

05/31/2012 997 Administrative Motion to File Under Seal Document Under Seal Re Apples Opposition To Samsungs Motion For Summary Judgment filed by Apple Inc.. (Attachments: # 1 [Proposed] Order Granting Apples Administrative Motion To File Document Under Seal Re Apples Opposition To Samsungs Motion For Summary Judgment, # 2 Apples Opposition To Samsungs Motion For Summary Judgment, # 3 [Proposed] Order Denying Samsungs Motion For Summary Judgment (Dkt. No. 930-1))(Jacobs, Michael) (Filed on 5/31/2012) (Entered: 05/31/2012)

05/31/2012 998 Declaration of Cyndi Wheeler In Support Of Apples Administrative Motions To File Documents Under Seal Re Apples Opposition To Samsungs Motion For Summary Judgment filed by Apple Inc.. (Jacobs, Michael) (Filed on 5/31/2012) (Entered: 05/31/2012)

05/31/2012 999 Administrative Motion to File Under Seal filed by Samsung Electronics America, Inc.(a New York corporation), Samsung Electronics Co. Ltd., Samsung Telecommunications

America, LLC(a Delaware limited liability company). (Attachments: # 1 Proposed Order Granting Motion to Seal, # 2 Samsung's Opposition to Apple's Motion to Exclude Testimony of Samsung's Experts, # 3 Declaration of Joby Martin in Support of Samsung's Opposition, # 4 Exhibit A to the Martin Declaration, # 5 Exhibit B to the Martin Declaration, # 6 Exhibit C to the Martin Declaration, # 7 Exhibit D to the Martin Declaration, # 8 Exhibit E to the Martin Declaration, # 9 Exhibit F to the Martin Declaration, # 10 Exhibit G to the Martin Declaration, # 11 Exhibit H to the Martin Declaration, # 12 Exhibit I to the Martin Declaration, # 13 Exhibit J to the Martin Declaration, # 14 Exhibit K to the Martin Declaration, # 15 Exhibit L to the Martin Declaration, # 16 Exhibit M to the Martin Declaration, # 17 Exhibit N to the Martin Declaration, # 18 Exhibit O to the Martin Declaration, # 19 Exhibit P to the Martin Declaration, # 20 Exhibit Q to the Martin Declaration, # 21 Exhibit R to the Martin Declaration, # 22 Exhibit S to the Martin Declaration, # 23 Proposed Order Denying Apple's Motion to Exclude Testimony of Samsung's Experts)(Maroulis, Victoria) (Filed on 5/31/2012) (Entered: 05/31/2012)

- 05/31/2012 1000 OPPOSITION to ( 999 Administrative Motion to File Under Seal Opposition to Apple's Motion to Strike Portions of Samsung's Expert Reports) (Public Redacted Version) filed by Samsung Electronics America, Inc.(a New York corporation), Samsung Electronics Co. Ltd., Samsung Telecommunications America, LLC(a Delaware limited liability company). (Attachments: # 1 Proposed Order Denying Apple's Motion to Strike)(Maroulis, Victoria) (Filed on 5/31/2012) Modified text on 6/4/2012 (dhm, COURT STAFF). (Entered: 05/31/2012)
- 05/31/2012 1001 Declaration of Woodward Yang, Ph.D. in Support of 1005 Samsung's Opposition to Apple's Motion for Summary Judgment of Non-Infringement of U.S. Patent No. 7,362,867 and Invalidity of U.S. Patent Nos. 7,456,893 and 7,577,460 filed by Samsung Electronics America, Inc.. (Maroulis, Victoria) (Filed on 5/31/2012) Modified on 6/4/2012 linking entry to document #1005 (dhm, COURT STAFF). (Entered: 05/31/2012)
- 06/01/2012 1002 Declaration of Sam Stake in Support of 1005 Samsung's Opposition to Apple's Motion for Summary Judgment filed by Samsung Electronics America, Inc.. (Attachments: # 1 Exhibit 1, # 2 Exhibit 2, # 3 Exhibit 3, # 4 Exhibit 4, # 5 Exhibit 5, # 6 Exhibit 6, # 7 Exhibit 7, # 8 Exhibit 8, # 9 Exhibit 9, # 10 Exhibit 10, # 11 Exhibit 11, # 12 Exhibit 12, # 13 Exhibit 13, # 14 Exhibit 14)(Maroulis, Victoria) (Filed on 6/1/2012) Modified on 6/4/2012 linking entry to document #1005 and correcting filing date. counsel posted document on 6/1/2012 (dhm, COURT STAFF). (Entered: 06/01/2012)
- 06/01/2012 1003 Declaration of Richard D. Wesel, Ph.D., in Support of 1005 Samsung's Opposition to Apple's Motion for Summary Judgment of Non-Infringement of U.S. Patent Number 7,362,867 filed by Samsung Electronics America, Inc.. (Attachments: # 1 Exhibit A, # 2 Exhibit B, # 3 Exhibit C, # 4 Exhibit D, # 5 Exhibit E, # 6 Exhibit F, # 7 Exhibit G, # 8 Exhibit H, # 9 Exhibit I, # 10 Exhibit J, # 11 Exhibit K, # 12 Exhibit L, # 13 Exhibit M, # 14 Exhibit N, # 15 Exhibit O, # 16 Exhibit P)(Maroulis, Victoria) (Filed on 6/1/2012) Modified on 6/4/2012 linking entry to document #1005 (dhm, COURT STAFF). (Entered: 06/01/2012)
- 06/01/2012 1004 Administrative Motion to File Under Seal Documents Under Seal Re Apples Opposition To Samsungs Motion For Summary Judgment filed by Apple Inc.. (Attachments: # 1 [Proposed] Order Granting Apples Administrative Motion To File Documents Under Seal Re Apples Opposition To Samsungs Motion For Summary Judgment)(Jacobs, Michael) (Filed on 6/1/2012) (Entered: 06/01/2012)
- 06/01/2012 1005 OPPOSITION to ( 925 Administrative Motion to File Under Seal Apple's Motion for Summary Judgment of Non-Infringement of U.S. Patent Number 7,362,867 and Invalidity of U.S. Patent Numbers 7,456,893 and 7,577,460 ) filed by Samsung Electronics America, Inc.. (Maroulis, Victoria) (Filed on 6/1/2012) Modified text on 6/4/2012 (dhm, COURT STAFF). (Entered: 06/01/2012)
- 06/01/2012 1006 Proposed Order re 1005 Denying Apple's Motion for Summary Judgment of Non-Infringement of U.S. Patent No. 7,362,867 and Invalidity of U.S. Patent Nos. 7,456,893 and 7,577,460 by Samsung Electronics America, Inc.. (Maroulis, Victoria) (Filed on 6/1/2012) Modified on 6/4/2012 linking entry to document #1005 (dhm, COURT STAFF). (Entered: 06/01/2012)
- 06/01/2012 1007 Administrative Motion to File Under Seal Samsung's Opposition to Apple's Motion for Summary Judgment and Documents in Support Thereto filed by Samsung Electronics America, Inc.. (Maroulis, Victoria) (Filed on 6/1/2012) (Entered: 06/01/2012)
- 06/01/2012 1008 Declaration of Ketan Patel in Support of 1007 Samsung's Administrative Motion to File Under Seal Its Opposition to Apple's Motion for Summary Judgment and Documents in Support Thereto filed by Samsung Electronics America, Inc.. (Maroulis, Victoria) (Filed on

- 6/1/2012) Modified on 6/4/2012 linking entry to document #1007 (dhm, COURT STAFF). (Entered: 06/01/2012)
- 06/01/2012 1009 Proposed Order re 1007 Samsung's Administrative Motion to File Under Seal Its Opposition to Apple's Motion for Summary Judgment and Documents in Support Thereof by Samsung Electronics America, Inc.. (Maroulis, Victoria) (Filed on 6/1/2012) Modified on 6/4/2012 linking entry to document #1007 (dhm, COURT STAFF). (Entered: 06/01/2012)
- 06/01/2012 1010 CERTIFICATE OF SERVICE by Samsung Electronics America, Inc. 1005 Samsung's Opposition to Apple's Motion for Summary Judgment and 1003 Documents in Support Thereof (Maroulis, Victoria) (Filed on 6/1/2012) Modified on 6/4/2012 linking entry to document #1003 and #1005 (dhm, COURT STAFF). (Entered: 06/01/2012)
- 06/01/2012 1011 Declaration in Support of 1000 Opposition/Response to Motion, Declaration of Joby Martin In Support of Samsung's Opposition to Apple's Motion to Strike filed by Samsung Electronics America, Inc.(a New York corporation), Samsung Electronics Co. Ltd., Samsung Telecommunications America, LLC(a Delaware limited liability company). (Attachments: # 1 Exhibit 2 to Martin Declaration, # 2 Exhibit 10 to Martin Declaration, # 3 Exhibit 11 to Martin Declaration, # 4 Exhibit 18 to Martin Declaration, # 5 Exhibit 19 to Martin Declaration)(Related document(s) 1000 ) (Maroulis, Victoria) (Filed on 6/1/2012) (Entered: 06/01/2012)
- 06/01/2012 1012 Declaration in Support of 1000 Opposition/Response to Motion, Declaration of Diane C. Hutnyan In Support of Samsung's Opposition to Apple's Motion to Strike filed by Samsung Electronics America, Inc.(a New York corporation), Samsung Electronics Co. Ltd., Samsung Telecommunications America, LLC(a Delaware limited liability company). (Related document(s) 1000 ) (Maroulis, Victoria) (Filed on 6/1/2012) (Entered: 06/01/2012)
- 06/01/2012 1013 Administrative Motion to File Under Seal Documents Under Seal Re Apples Opposition To Samsungs Motion For Summary Judgment filed by Apple Inc.. (Attachments: # 1 Proposed Order, # 2 Declaration Of Karl Kramer In Support Of Apples Opposition To Samsungs Motion For Summary Judgment, # 3 Exhibit Kramer Decl. Ex. 1, # 4 Exhibit Kramer Decl. Ex. 2, # 5 Exhibit Kramer Decl. Ex. 3, # 6 Exhibit Kramer Decl. Ex. 4, # 7 Exhibit Kramer Decl. Ex. 5, # 8 Exhibit Kramer Decl. Ex. 6, # 9 Exhibit Kramer Decl. Ex. 7, # 10 Exhibit Kramer Decl. Ex. 8, # 11 Exhibit Kramer Decl. Ex. 9, # 12 Exhibit Kramer Decl. Ex. 10, # 13 Exhibit Kramer Decl. Ex. 11, # 14 Declaration Of Michel Maharbiz, Ph.D. In Support Of Apples Opposition To Samsungs Motion For Summary Judgment, # 15 Exhibit Maharbiz Decl. Ex. A, # 16 Exhibit Maharbiz Decl. Ex. B, # 17 Exhibit Maharbiz Decl. Ex. E, # 18 Exhibit Maharbiz Decl. Ex. F)(Jacobs, Michael) (Filed on 6/1/2012) (Entered: 06/01/2012)
- 06/01/2012 1014 Declaration in Support of 1000 Opposition/Response to Motion, Declaration of James Ward In Support of Samsung's Opposition to Apple's Motion to Strike filed by Samsung Electronics America, Inc.(a New York corporation), Samsung Electronics Co. Ltd., Samsung Telecommunications America, LLC(a Delaware limited liability company). (Attachments: # 1 Exhibit A, # 2 Exhibit B, # 3 Exhibit E, # 4 Exhibit F, # 5 Exhibit L, # 6 Exhibit M, # 7 Exhibit N, # 8 Exhibit O, # 9 Exhibit P, # 10 Exhibit R, # 11 Exhibit S, # 12 Exhibit U, # 13 Exhibit V, # 14 Exhibit W, # 15 Exhibit AA, # 16 Exhibit BB, # 17 Exhibit CC, # 18 Exhibit EE)(Related document(s) 1000 ) (Maroulis, Victoria) (Filed on 6/1/2012) (Entered: 06/01/2012)
- 06/01/2012 1015 Declaration of Mark D. Selwyn in Support of 997 Administrative Motion to File Under Seal Document Under Seal Re Apples Opposition To Samsungs Motion For Summary Judgment , 1004 Administrative Motion to File Under Seal Documents Under Seal Re Apples Opposition To Samsungs Motion For Summary Judgment filed by Apple Inc.(a California corporation). (Attachments: # 1 Exhibit A, # 2 Exhibit B)(Related document(s) 997 , 1004 ) (Selwyn, Mark) (Filed on 6/1/2012) (Entered: 06/01/2012)
- 06/01/2012 1016 Declaration in Support of 999 Administrative Motion to File Under Seal Declaration of Hankil Kang In Support of Samsung's Administrative Motion to File Documents Under Seal filed by Samsung Electronics America, Inc.(a New York corporation), Samsung Electronics Co. Ltd., Samsung Telecommunications America, LLC(a Delaware limited liability company). (Related document(s) 999 ) (Maroulis, Victoria) (Filed on 6/1/2012) (Entered: 06/01/2012)
- 06/01/2012 1017 CERTIFICATE OF SERVICE by Samsung Electronics America, Inc.(a New York corporation), Samsung Electronics Co. Ltd., Samsung Telecommunications America, LLC (a Delaware limited liability company) re 1000 Opposition/Response to Motion, (Maroulis, Victoria) (Filed on 6/1/2012) (Entered: 06/01/2012)

- 06/01/2012 1018 Declaration of Janusz A. Ordovery, Ph.D. in Support of 997 Administrative Motion to File Under Seal Document Under Seal Re Apples Opposition To Samsungs Motion For Summary Judgment , 1004 Administrative Motion to File Under Seal Documents Under Seal Re Apples Opposition To Samsungs Motion For Summary Judgment filed by Apple Inc.(a California corporation). (Attachments: # 1 Exhibit A, # 2 Exhibit B)(Related document(s) 997 , 1004 ) (Selwyn, Mark) (Filed on 6/1/2012) (Entered: 06/01/2012)
- 06/01/2012 1019 CERTIFICATE OF SERVICE by Apple Inc.(a California corporation) re 1018 Declaration in Support,, 1015 Declaration in Support,, of Apple's Opposition to Samsung's Motion for Summary Judgment (Selwyn, Mark) (Filed on 6/1/2012) (Entered: 06/01/2012)
- 06/01/2012 1020 Administrative Motion to File Under Seal Documents Under Seal Re Apples Opposition To Samsungs Motion For Summary Judgment filed by Apple Inc.. (Attachments: # 1 Proposed Order, # 2 Declaration Of Jason R. Bartlett In Support Of Apples Opposition To Samsungs Motion For Summary Judgment, # 3 Bartlett Decl. Ex. 8, # 4 Bartlett Decl. Ex. 9, # 5 Bartlett Decl. Ex. 10, # 6 Bartlett Decl. Ex. 11, # 7 Bartlett Decl. Ex. 17, # 8 Bartlett Decl. Ex. 18, # 9 Bartlett Decl. Ex. 19, # 10 Bartlett Decl. Ex. 23, # 11 Bartlett Decl. Ex. 26, # 12 Bartlett Decl. Ex. 30, # 13 Bartlett Decl. Ex. 31, # 14 Bartlett Decl. Ex. 32, # 15 Bartlett Decl. Ex. 53, # 16 Bartlett Decl. Ex. 54, # 17 Bartlett Decl. Ex. 55, # 18 Bartlett Decl. Ex. 57, # 19 Bartlett Decl. Ex. 58, # 20 Bartlett Decl. Ex. 59, # 21 Bartlett Decl. Ex. 60, # 22 Bartlett Decl. Ex. 61, # 23 Bartlett Decl. Ex. 62, # 24 Bartlett Decl. Ex. 64, # 25 Bartlett Decl. Ex. 67, # 26 Bartlett Decl. Ex. 80)(Jacobs, Michael) (Filed on 6/1/2012) (Entered: 06/01/2012)
- 06/01/2012 1021 Declaration Of Susan Kare In Support Of Apples Opposition To Samsungs Motion For Summary Judgment filed by Apple Inc.. (Attachments: # 1 Exhibit 1, # 2 Exhibit 2) (Jacobs, Michael) (Filed on 6/1/2012) (Entered: 06/01/2012)
- 06/01/2012 1022 Administrative Motion to File Under Seal Documents Re Apples Opposition To Samsungs Motion For Summary Judgment filed by Apple Inc.. (Attachments: # 1 Proposed Order, # 2 Declaration Of Peter W. Bressler In Support Of Apples Opposition To Samsungs Motion For Summary Judgment, # 3 Exhibit 1, # 4 Exhibit 2, # 5 Exhibit 3, # 6 Exhibit 4, # 7 Exhibit 5, # 8 Exhibit 6, # 9 Exhibit 7, # 10 Exhibit 8, # 11 Exhibit 9, # 12 Exhibit 10, # 13 Exhibit 11, # 14 Exhibit 12, # 15 Exhibit 13, # 16 Exhibit 14, # 17 Exhibit 15, # 18 Exhibit 16, # 19 Exhibit 17, # 20 Exhibit 18, # 21 Exhibit 19, # 22 Exhibit 20, # 23 Exhibit 23, # 24 Exhibit 24, # 25 Exhibit 59, # 26 Exhibit 60, # 27 Exhibit 61, # 28 Exhibit 62, # 29 Exhibit 63, # 30 Exhibit 64 (Part 1 of 2), # 31 Exhibit 64 (Part 2 of 2), # 32 Exhibit 65, # 33 Exhibit 66, # 34 Exhibit 83, # 35 Exhibit 84, # 36 Exhibit 85, # 37 Exhibit 86, # 38 Exhibit 87, # 39 Exhibit 88, # 40 Exhibit 89, # 41 Exhibit 90, # 42 Exhibit 91, # 43 Exhibit 92, # 44 Exhibit 93)(Jacobs, Michael) (Filed on 6/1/2012) (Entered: 06/01/2012)
- 06/01/2012 1023 Administrative Motion to File Under Seal Documents Re Apples Opposition To Samsungs Motion For Summary Judgment filed by Apple Inc.. (Attachments: # 1 Proposed Order, # 2 Declaration Of Russell S. Winer In Support Of Apples Opposition To Samsungs Motion For Summary Judgment, # 3 Declaration Of Dr. Alan Hedge In Support Of Apples Opposition To Samsungs Motion For Summary Judgment, # 4 Exhibit A (Volume 1 of 5), # 5 Exhibit A (Volume 2 of 5), # 6 Exhibit A (Volume 3 of 5), # 7 Exhibit A (Volume 4 of 5), # 8 Exhibit A (Volume 5 of 5))(Jacobs, Michael) (Filed on 6/1/2012) (Entered: 06/01/2012)
- 06/01/2012 1024 Administrative Motion to File Under Seal Documents Re Apples Opposition To Samsungs Motion For Summary Judgment filed by Apple Inc.. (Attachments: # 1 Proposed Order, # 2 Declaration Of Dr. Karan Singh, Ph.D. In Support Of Apples Opposition To Samsungs Motion For Summary Judgment, # 3 Singh Decl. Ex. 1, # 4 Singh Decl. Ex. 2, # 5 Singh Decl. Ex. 3, # 6 Singh Decl. Ex. 4, # 7 Singh Decl. Ex. 5, # 8 Singh Decl. Ex. 6, # 9 Singh Decl. Ex. 7, # 10 Singh Decl. Ex. 8, # 11 Singh Decl. Ex. 9, # 12 Singh Decl. Ex. 10, # 13 Declaration Of Ravin Balakrishnan, Ph.D. In Support Of Apples Opposition To Samsungs Motion For Summary Judgment, # 14 Balakrishnan Decl. Ex. 1, # 15 Balakrishnan Decl. Ex. 2, # 16 Balakrishnan Decl. Ex. 3)(Jacobs, Michael) (Filed on 6/1/2012) (Entered: 06/01/2012)
- 06/01/2012 1025 CERTIFICATE OF SERVICE by Apple Inc. Apples Opposition To Samsungs Motion To Exclude Opinions Of Certain Of Apple Experts (Jacobs, Michael) (Filed on 6/1/2012) (Entered: 06/01/2012)
- 06/01/2012 1026 CERTIFICATE OF SERVICE by Apple Inc. Apple Inc.s Reply In Support Of Motion Pursuant To Rule 62(C) For Entry Of Preliminary Injunction Without Further Hearing (Jacobs, Michael) (Filed on 6/1/2012) (Entered: 06/01/2012)
- 06/01/2012 1027 CERTIFICATE OF SERVICE by Apple Inc. Apples Opposition To Samsungs Motion To Strike Expert Testimony Based On Undisclosed Facts And Theories (Jacobs, Michael) (Filed on

6/1/2012) (Entered: 06/01/2012)

- 06/01/2012 1028 CERTIFICATE OF SERVICE by Apple Inc. Apples Opposition To Samsungs Motion For Summary Judgment and Supporting Documents (Jacobs, Michael) (Filed on 6/1/2012) (Entered: 06/01/2012)
- 06/01/2012 1029 Declaration of Cyndi Wheeler in Support of 977 Administrative Motion to File Under Seal filed by Apple Inc.(a California corporation). (Attachments: # 1 Proposed Order [Proposed] Order Granting Samsung's Administrative Motion to File Documents Under Seal re Samsung's Opposition to Apple's Motion for Entry of Preliminary Injunction) (Related document(s) 977 ) (Bartlett, Jason) (Filed on 6/1/2012) (Entered: 06/01/2012)
- 06/01/2012 1030 CLERK'S NOTICE RESETTING 6/26/2012 MOTIONS: 6/26/2012 Motions (In Re: Docket Nos. 885 , 895 , 939 , 965 , and 968 ) reset to 6/21/2012 at 10:00 AM (Special Set) in Courtroom 5, 4th Floor, San Jose before Magistrate Judge Paul Singh Grewal. \*\*\*This is a text only docket entry, there is no document associated with this notice.\*\*\* (ofr, COURT STAFF) (Filed on 6/1/2012) (Entered: 06/01/2012)
- 06/04/2012 1031 Declaration of Cyndi Wheeler in Support of 978 Administrative Motion to File Under Seal filed by Apple Inc.(a California corporation). (Attachments: # 1 Exhibit 1, # 2 Exhibit 2, # 3 Exhibit 3, # 4 Exhibit 4, # 5 Exhibit 5, # 6 Proposed Order)(Related document(s) 978 ) (Bartlett, Jason) (Filed on 6/4/2012) (Entered: 06/04/2012)
- 06/04/2012 1032 ORDER by Judge Lucy H. Koh denying 951 Motion for Preliminary Injunction (lhkic2, COURT STAFF) (Filed on 6/4/2012) (Entered: 06/04/2012)
- 06/04/2012 -- Set/Reset Hearing (lhkic2, COURT STAFF) (Filed on 6/4/2012) (Entered: 06/04/2012)
- 06/04/2012 1033 \*\*\* FILED IN ERROR. REFER TO DOCUMENT 1035 . \*\*\* Administrative Motion to File Under Seal filed by Apple Inc.. (Attachments: # 1 Proposed Order, # 2 Public Opposition to Motion for Leave to Seek Reconsideration of May 21, 2012 Order, # 3 Proposed Order, # 4 Declaration of Grant L. Kim in Support of Opposition, # 5 Exhibit A to Public Kim Declaration, # 6 Exhibit B to Public Kim Declaration, # 7 Exhibit C to Public Kim Declaration, # 8 Exhibit D to Public Kim Declaration)(Jacobs, Michael) (Filed on 6/4/2012) Modified on 6/5/2012 (fff, COURT STAFF). (Entered: 06/04/2012)
- 06/04/2012 1034 ORDER by Judge Lucy H. Koh granting in part and denying in part 977 Administrative Motion to File Under Seal; granting in part and denying in part 978 Administrative Motion to File Under Seal; granting 993 Administrative Motion to File Under Seal (lhkic2, COURT STAFF) (Filed on 6/4/2012) (Entered: 06/04/2012)
- 06/05/2012 1035 Administrative Motion to File Under Seal CORRECTION OF DOCKET # 1033 filed by Apple Inc.. (Attachments: # 1 Proposed Order, # 2 Public Opposition to Motion for Leave to Seek Reconsideration, # 3 Proposed Order, # 4 Grant L. Kim Declaration in Support of Opposition, # 5 Exhibit A (Public), # 6 Exhibit B, # 7 Exhibit C, # 8 Exhibit D)(Jacobs, Michael) (Filed on 6/5/2012) (Entered: 06/05/2012).
- 06/05/2012 1036 Minute Entry: Motion Hearing held on 6/5/2012 before Magistrate Judge Paul S. Grewal (Date Filed: 6/5/2012) re 891 MOTION to Seal Portions of Hearing Transcript re 855 Transcript,, filed by Samsung Electronics Co. Ltd., Samsung Telecommunications America, LLC, Samsung Electronics America, Inc. The Court denies Samsung's motion to seal portions of 3/27/2012 hearing transcript. (Court Reporter: Lee-Anne Shortridge.) (ofr, COURT STAFF) (Date Filed: 6/5/2012) (Entered: 06/05/2012)
- 06/05/2012 1037 Declaration of CYNDI WHEELER in Support of 987 Administrative Motion to File Under Seal filed by Apple Inc.. (Related document(s) 987 ) (Jacobs, Michael) (Filed on 6/5/2012) (Entered: 06/05/2012)
- 06/05/2012 1038 Declaration of Erica Tierney in Support of 984 Administrative Motion to File Under Seal , 994 Administrative Motion to File Under Seal Second Supplemental Price Declaration in Support of (Dkt No. 934) Samsung's Motion to Strike , 990 Administrative Motion to File Under Seal Corrected Supplemental Price Declaration filed by Apple Inc.(a California corporation). (Attachments: # 1 Exhibit 1, # 2 Exhibit 2, # 3 Proposed Order)(Related document(s) 984 , 994 , 990 ) (Selwyn, Mark) (Filed on 6/5/2012) (Entered: 06/05/2012)
- 06/05/2012 1039 MOTION to Remove Incorrectly Filed Document [Docket Nos. 1033 through 1033-8] filed by Apple Inc.. (Jacobs, Michael) (Filed on 6/5/2012) (Entered: 06/05/2012)
- 06/05/2012 1040 OPPOSITION to 967 MOTION for Clarification of April 12 Order by Samsung Electronics America, Inc.(a New York corporation), Samsung Electronics Co. Ltd., Samsung Telecommunications America, LLC(a Delaware limited liability company) (Attachments: # 1 Declaration Of Diane C. Hutnyan In Support of Samsung's Opposition to Notice of Motion for Clarification of April 12 Order, # 2 Exhibit A to Declaration Of Diane C.

Hutnyan In Support of Samsung's Opposition to Notice of Motion for Clarification of April 12 Order, # 3 Exhibit B to Declaration Of Diane C. Hutnyan In Support of Samsung's Opposition to Notice of Motion for Clarification of April 12 Order, # 4 Exhibit C to Declaration Of Diane C. Hutnyan In Support of Samsung's Opposition to Notice of Motion for Clarification of April 12 Order, # 5 Exhibit D to Declaration Of Diane C. Hutnyan In Support of Samsung's Opposition to Notice of Motion for Clarification of April 12 Order) (Maroulis, Victoria) (Filed on 6/5/2012) Modified text on 6/6/2012 (dhm, COURT STAFF). (Entered: 06/05/2012)

- 06/05/2012 1041 Administrative Motion to File Under Seal Apple Inc.'s Opposition to Samsung's Motion to Enforce April 12, 2012 Order filed by Apple Inc.. (Attachments: # 1 Declaration of Erica Tierney in Support of Admin. Motion to Seal, # 2 Proposed Order Granting Motion to Seal, # 3 Apple's Opposition to Samsung's Motion to Enforce April 12, 2012 Order, # 4 Proposed Order Denying Samsung's Motion, # 5 Declaration of Mia Mazza in Support of Apple's Opposition, # 6 Exhibit 1, # 7 Exhibit 2, # 8 Exhibit 3, # 9 Exhibit 4, # 10 Exhibit 5, # 11 Exhibit 6, # 12 Exhibit 7)(Jacobs, Michael) (Filed on 6/5/2012) Modified on 6/6/2012 pursuant to General Order No. 62, attachment #1 sealed (dhm, COURT STAFF). (Entered: 06/05/2012)
- 06/05/2012 1042 OPPOSITION to ( 968 MOTION Rule 37 Sanctions re December 22, 2011 Court Order ) filed by Apple Inc.. (Attachments: # 1 Proposed Order)(Jacobs, Michael) (Filed on 6/5/2012) Modified text on 6/6/2012 (dhm, COURT STAFF). (Entered: 06/05/2012)
- 06/05/2012 1043 Declaration of Nathan Sabri in Support of 1042 Opposition/Response to Motion, 1041 Administrative Motion to File Under Seal Apple Inc.'s Opposition to Samsung's Motion to Enforce April 12, 2012 Order filed by Apple Inc.. (Attachments: # 1 Exhibit 1, # 2 Exhibit 2, # 3 Exhibit 3, # 4 Exhibit 4, # 5 Exhibit 5, # 6 Exhibit 6, # 7 Exhibit 7, # 8 Exhibit 8, # 9 Exhibit 9, # 10 Exhibit 10, # 11 Exhibit 11, # 12 Exhibit 12, # 13 Exhibit 13, # 14 Exhibit 14, # 15 Exhibit 15, # 16 Exhibit 16, # 17 Exhibit 17, # 18 Exhibit 18, # 19 Exhibit 19, # 20 Exhibit 20, # 21 Exhibit 21, # 22 Exhibit 22, # 23 Exhibit 23, # 24 Exhibit 24, # 25 Exhibit 25, # 26 Exhibit 26, # 27 Exhibit 27)(Related document(s) 1042 , 1041 ) (Jacobs, Michael) (Filed on 6/5/2012) (Entered: 06/05/2012)
- 06/05/2012 1044 Administrative Motion to File Under Seal Samsung's Reply In Support of Motion For Clarification of May 4, 2012 Order filed by Samsung Electronics America, Inc.(a New York corporation), Samsung Electronics Co. Ltd., Samsung Telecommunications America, LLC (a Delaware limited liability company). (Attachments: # 1 Samsung's Reply In Support of Motion For Clarification of May 4, 2012 Order, # 2 Declaration of Dr. Jeffrey Johnson, # 3 Exhibit 1 to Johnson Declaration, # 4 Declaration of Mark Tung, # 5 Exhibit 1, # 6 Exhibit 2, # 7 Exhibit 3)(Maroulis, Victoria) (Filed on 6/5/2012) (Entered: 06/05/2012)
- 06/05/2012 1045 Declaration of Rosa Kim in Support of 1044 Administrative Motion to File Under Seal Samsung's Reply In Support of Motion For Clarification of May 4, 2012 Order , 986 Administrative Motion to File Under Seal filed by Samsung Electronics America, Inc.(a New York corporation), Samsung Electronics Co. Ltd., Samsung Telecommunications America, LLC(a Delaware limited liability company). (Attachments: # 1 Proposed Order Granting Administrative Motions to File Documents Under Seal)(Related document(s) 1044 , 986 ) (Maroulis, Victoria) (Filed on 6/5/2012) (Entered: 06/05/2012)
- 06/05/2012 1046 CERTIFICATE OF SERVICE by Samsung Electronics America, Inc.(a New York corporation), Samsung Electronics Co. Ltd., Samsung Telecommunications America, LLC (a Delaware limited liability company) re 1044 Administrative Motion to File Under Seal Samsung's Reply In Support of Motion For Clarification of May 4, 2012 Order (Maroulis, Victoria) (Filed on 6/5/2012) (Entered: 06/05/2012)
- 06/05/2012 1047 Administrative Motion to File Under Seal Apple's Reply in Support of Motion for Adverse Inference Jury Instructions Due to Samsung's Spoliation of Evidence (Dkt. 895) filed by Apple Inc.. (Attachments: # 1 Proposed Order, # 2 Apple's Reply Brief, # 3 Declaration of Esther Kim)(Jacobs, Michael) (Filed on 6/5/2012) (Entered: 06/05/2012)
- 06/06/2012 1048 CERTIFICATE OF SERVICE by Apple Inc. re 1047 Administrative Motion to File Under Seal Apple's Reply in Support of Motion for Adverse Inference Jury Instructions Due to Samsung's Spoliation of Evidence (Dkt. 895) , 1041 Administrative Motion to File Under Seal Apple Inc.'s Opposition to Samsung's Motion to Enforce April 12, 2012 Order (Jacobs, Michael) (Filed on 6/6/2012) (Entered: 06/06/2012)
- 06/06/2012 1049 Transcript of Proceedings held on 06-05-12, before Judge Paul S. Grewal. Court Reporter/Transcriber Lee-Anne Shortridge, Telephone number 408-287-4580. Per General Order No. 59 and Judicial Conference policy, this transcript may be viewed only at the Clerks Office public terminal or may be purchased through the Court Reporter/Transcriber until the deadline for the Release of Transcript Restriction.After that date it may be obtained through PACER. Any Notice of Intent to Request Redaction, if

required, is due no later than 5 business days from date of this filing. Release of Transcript Restriction set for 9/4/2012. (las, ) (Filed on 6/6/2012) (Entered: 06/06/2012)

- 06/06/2012 1050 NOTICE of Lodging re 940 Corrected Exhibit 11 to the Declaration of Jason Bartlett in Support of Apple's Motion to Exclude Testimony of Samsung's Expert by Apple Inc. (Jacobs, Michael) (Filed on 6/6/2012) Modified text on 6/7/2012 (dhm, COURT STAFF). (Entered: 06/06/2012)
- 06/07/2012 1051 Declaration of Peter Kolovos in Support of 999 Administrative Motion to File Under Seal Samsung's Opposition to Apple's Motion to Strike Portions of Samsung's Expert Reports filed by Apple Inc.(a California corporation). (Attachments: # 1 Proposed Order)(Related document(s) 999 ) (Selwyn, Mark) (Filed on 6/7/2012) (Entered: 06/07/2012)
- 06/07/2012 1052 Administrative Motion to File Under Seal Apple's Reply Brief in Support of Its Motion for Summary Judgment filed by Apple Inc.(a California corporation). (Attachments: # 1 Proposed Order, # 2 Reply Brief, # 3 Declaration, # 4 Exhibit, # 5 Exhibit)(Selwyn, Mark) (Filed on 6/7/2012) (Entered: 06/07/2012)
- 06/07/2012 1053 CERTIFICATE OF SERVICE by Apple Inc.(a California corporation) re 1052 Administrative Motion to File Under Seal Apple's Reply Brief in Support of Its Motion for Summary Judgment (Selwyn, Mark) (Filed on 6/7/2012) (Entered: 06/07/2012)
- 06/07/2012 1054 REPLY (re 939 Administrative Motion to File Under Seal Apple's Administrative Motion to File Documents Under Seal ) filed by Apple Inc.. (Jacobs, Michael) (Filed on 6/7/2012) (Entered: 06/07/2012)
- 06/07/2012 1055 Declaration of Yakov Zolotorev in Support of 1054 Reply to Opposition/Response re Apple's Motion to Strike Portions of Samsung's Expert Reports filed by Apple Inc.. (Related document(s) 1054 ) (Jacobs, Michael) (Filed on 6/7/2012) (Entered: 06/07/2012)
- 06/07/2012 1056 Administrative Motion to File Under Seal Reply Declaration of Marc J. Pernick in Support of Apple's Motion to Strike Portions of Samsung's Expert Reports filed by Apple Inc.. (Attachments: # 1 Declaration of Marc J. Pernick in Support of Reply re Apple's Motion to Strike Portions of Samsung's Expert Reports, # 2 Exhibit 1, # 3 Exhibit 2, # 4 Exhibit 3, # 5 Exhibit 4, # 6 Exhibit 5, # 7 Exhibit 6, # 8 Exhibit 7, # 9 Exhibit 8, # 10 Exhibit 9, # 11 Exhibit 10, # 12 Exhibit 11)(Jacobs, Michael) (Filed on 6/7/2012) (Entered: 06/07/2012)
- 06/07/2012 1057 Declaration of Cyndi Wheeler in Support of 999 Administrative Motion to File Under Seal , 1007 Administrative Motion to File Under Seal Samsung's Opposition to Apple's Motion for Summary Judgment and Documents in Support Thereto , Samsung's Oppotioin to Apple's Motion to Strike, and Samsung's Opposition to Motion to Exclude filed by Apple Inc.. (Attachments: # 1 Proposed Order, # 2 Exhibit A, # 3 Exhibit B, # 4 Exhibit C, # 5 Exhibit D, # 6 Exhibit E, # 7 Exhibit F, # 8 Exhibit G, # 9 Exhibit H, # 10 Exhibit I, # 11 Exhibit J, # 12 Exhibit K)(Related document(s) 999 , 1007 ) (Jacobs, Michael) (Filed on 6/7/2012) (Entered: 06/07/2012)
- 06/07/2012 1058 EXHIBITS re 1057 Declaration in Support,, Exhibit L to Declaration of Cyndi Wheeler in Support of Samsung's Administrative Motions to File Under Seal filed by Apple Inc.. (Related document(s) 1057 ) (Jacobs, Michael) (Filed on 6/7/2012) (Entered: 06/07/2012)
- 06/07/2012 1059 Administrative Motion to File Under Seal Apply's Reply to Samsung's Opposition to Apple's Motion to Exclude Opinions of Certain of Samsung's Experts filed by Apple Inc.. (Attachments: # 1 Public Reply, # 2 Reply Declaration, # 3 Exhibit 1)(Jacobs, Michael) (Filed on 6/7/2012) (Entered: 06/07/2012)
- 06/07/2012 1060 \*\*\* Declaration of Trevor Darrell in Support of Samsung's Reply and Exhibit D and E to Darrell Declaration FILED IN ERROR WITH CONFIDENTIAL INFORMATION. DOCUMENT LOCKED. \*\*\* Administrative Motion to File Under Seal filed by Samsung Electronics America, Inc.(a New York corporation), Samsung Electronics Co. Ltd., Samsung Telecommunications America, LLC(a Delaware limited liability company). (Attachments: # 1 Proposed Order Granting Motion to File Documents Under Seal, # 2 Samsung's Reply in Support of Motion to Strike Expert Testimony Based on Undisclosed Facts and Theories, # 3 Declaration of Christopher E. Price in Support of Samsung's Reply, # 4 Exhibit 1 to Price Declaration, # 5 Exhibit 2 to Price Declaration, # 6 Exhibit 3 to Price Declaration, # 7 Exhibit 4 to Price Declaration, # 8 Exhibit 5 to Price Declaration, # 9 Exhibit 6 to Price Declaration, # 10 Exhibit 7 to Price Declaration, # 11 Exhibit 8 to Price Declaration, # 12 Exhibit 9 to Price Declaration, # 13 Exhibit 10 to Price Declaration, # 14 Exhibit 11 to Price Declaration, # 15 Exhibit 12 to Price Declaration, # 16 Exhibit 13 to Price Declaration, # 17 Exhibit 14 to Price Declaration, # 18 Exhibit 15 to Price



Declaration, # 19 Exhibit 16 to Price Declaration, # 20 Exhibit 17 to Price Declaration, # 21 Exhibit 18 to Price Declaration, # 22 Exhibit 19 to Price Declaration, # 23 Exhibit 20 to Price Declaration, # 24 Exhibit 21 to Price Declaration, # 25 Exhibit 22 to Price Declaration, # 26 Exhibit 23 to Price Declaration, # 27 Exhibit 24 to Price Declaration, # 28 Exhibit 25 to Price Declaration, # 29 Exhibit 26 to Price Declaration, # 30 Exhibit 27 to Price Declaration, # 31 Exhibit 28 to Price Declaration, # 32 Exhibit 29 to Price Declaration, # 33 Exhibit 30 to Price Declaration, # 34 Exhibit 31 to Price Declaration, # 35 Declaration of Michael J. Wagner in Support of Samsung's Reply, # 36 Exhibit A to Wagner Declaration, # 37 Exhibit B to Wagner Declaration, # 38 Exhibit C to Wagner Declaration, # 39 Declaration of Trevor Darrell in Support of Samsung's Reply, # 40 Exhibit A to Darrell Declaration, # 41 Exhibit B to Darrell Declaration, # 42 Exhibit C to Darrell Declaration, # 43 Exhibit D to Darrell Declaration, # 44 Exhibit E to Darrell Declaration)(Maroulis, Victoria) (Filed on 6/7/2012) Modified on 6/8/2012 (fff, COURT STAFF). (Entered: 06/07/2012)

06/07/2012 1061 Administrative Motion to File Under Seal Samsung's Reply In Support of Motion To Exclude Opinions of Certain of Apple's Experts filed by Samsung Electronics America, Inc. (a New York corporation), Samsung Electronics Co. Ltd., Samsung Telecommunications America, LLC(a Delaware limited liability company). (Attachments: # 1 Samsung's Reply In Support of Motion To Exclude Opinions of Certain of Apple's Experts, # 2 Declaration Declaration of Joby Martin, # 3 Exhibit 2, # 4 Exhibit 3, # 5 Proposed Order Granting Samsung's Administrative Motion to File Documents Under Seal)(Maroulis, Victoria) (Filed on 6/7/2012) (Entered: 06/07/2012)

06/07/2012 1062 Declaration of Joby Martin in Support of 996 Administrative Motion to File Under Seal Documents Under Seal Re Apples Opposition To Samsungs Motion To Strike Expert Testimony filed by Samsung Electronics America, Inc.(a New York corporation), Samsung Electronics Co. Ltd., Samsung Telecommunications America, LLC(a Delaware limited liability company). (Related document(s) 996 ) (Maroulis, Victoria) (Filed on 6/7/2012) (Entered: 06/07/2012)

06/07/2012 1063 \*\*\* ATTACHMENT 2 FILED IN ERROR WITH CONFIDENTIAL INFORMATION. DOCUMENT LOCKED. DOCUMENT TO BE REFILED LATER. \*\*\* Administrative Motion to File Under Seal Samsung's Reply in Support of Samsung's Motion for Summary Judgment filed by Samsung Electronics Co. Ltd.. (Attachments: # 1 Proposed Order, # 2 Reply in Support of Samsung's Motion for Summary Judgment)(Maroulis, Victoria) (Filed on 6/7/2012) Modified on 6/8/2012 (fff, COURT STAFF). (Entered: 06/07/2012)

06/08/2012 1064 Declaration of Joby Martin in Support of 997 Administrative Motion to File Under Seal Document Under Seal Re Apples Opposition To Samsungs Motion For Summary Judgment , 1004 Administrative Motion to File Under Seal Documents Under Seal Re Apples Opposition To Samsungs Motion For Summary Judgment , 991 Administrative Motion to File Under Seal Documents Re Apples Opposition To Samsungs Motion To Exclude Opinions Of Certain Of Apple Experts , 1035 Administrative Motion to File Under Seal CORRECTION OF DOCKET # 1033 , 1033 Administrative Motion to File Under Seal filed by Samsung Electronics America, Inc.(a New York corporation), Samsung Electronics Co. Ltd., Samsung Telecommunications America, LLC(a Delaware limited liability company). (Attachments: # 1 Proposed Order Granting Apple's Administrative Motion to File Documents Under Seal)(Related document(s) 997 , 1004 , 991 , 1035 , 1033 ) (Maroulis, Victoria) (Filed on 6/8/2012) (Entered: 06/08/2012)

06/08/2012 1065 Declaration of Stephen Gray in Support of 1063 Administrative Motion to File Under Seal Samsung's Reply in Support of Samsung's Motion for Summary Judgment filed by Samsung Electronics Co. Ltd.. (Related document(s) 1063 ) (Maroulis, Victoria) (Filed on 6/8/2012) (Entered: 06/08/2012)

06/08/2012 1066 Supplemental Declaration of Adam Bogue in Support of 1063 Administrative Motion to File Under Seal Samsung's Reply in Support of Samsung's Motion for Summary Judgment filed by Samsung Electronics Co. Ltd.. (Attachments: # 1 Exhibit 1, # 2 Exhibit 2, # 3 Exhibit 3)(Related document(s) 1063 ) (Maroulis, Victoria) (Filed on 6/8/2012) Modified text on 6/11/2012 (dhm, COURT STAFF). (Entered: 06/08/2012)

06/08/2012 1067 Administrative Motion to File Under Seal filed by Samsung Electronics America, Inc.(a New York corporation), Samsung Electronics Co. Ltd., Samsung Telecommunications America, LLC(a Delaware limited liability company). (Attachments: # 1 Proposed Order Granting Motion to Seal, # 2 Declaration of Brian von Herzen in Support of Samsung's Reply in Support of Motion to Strike Expert Testimony Based on Undisclosed Facts and Theories, # 3 Exhibit 1 to von Herzen Declaration, # 4 Exhibit 2 to von Herzen Declaration, # 5 Exhibit 3 to von Herzen Declaration, # 6 Exhibit 4 to von Herzen Declaration, # 7 Exhibit 5 to von Herzen Declaration, # 8 Exhibit 6 to von Herzen Declaration)(Maroulis, Victoria) (Filed on 6/8/2012) (Entered: 06/08/2012)

- 06/08/2012 1068 Declaration of Bill Trac in Support of 1063 Administrative Motion to File Under Seal Samsung's Reply in Support of Samsung's Motion for Summary Judgment filed by Samsung Electronics Co. Ltd.. (Attachments: # 1 Exhibit 1, # 2 Exhibit 2, # 3 Exhibit 3, # 4 Exhibit 4, # 5 Exhibit 5, # 6 Exhibit 6, # 7 Exhibit 7, # 8 Exhibit 8, # 9 Exhibit 9, # 10 Exhibit 10, # 11 Exhibit 11, # 12 Exhibit 12, # 13 Exhibit 13, # 14 Exhibit 14, # 15 Exhibit 15, # 16 Exhibit 16, # 17 Exhibit 17, # 18 Exhibit 18, # 19 Exhibit 19, # 20 Exhibit 20, # 21 Exhibit 21, # 22 Exhibit 22, # 23 Exhibit 23, # 24 Exhibit 24, # 25 Exhibit 25, # 26 Exhibit 26, # 27 Exhibit 27, # 28 Exhibit 28)(Related document(s) 1063 ) (Maroulis, Victoria) (Filed on 6/8/2012) (Entered: 06/08/2012)
- 06/08/2012 1069 Administrative Motion to File Under Seal Exhibits to Trac Declaration in Support of Reply to Samsung's Motion for Summary Judgment filed by Samsung Electronics Co. Ltd.. (Attachments: # 1 Proposed Order)(Maroulis, Victoria) (Filed on 6/8/2012) (Entered: 06/08/2012)
- 06/08/2012 1070 CERTIFICATE OF SERVICE by Samsung Electronics Co. Ltd. re 1069 Administrative Motion to File Under Seal Exhibits to Trac Declaration in Support of Reply to Samsung's Motion for Summary Judgment , 1063 Administrative Motion to File Under Seal Samsung's Reply in Support of Samsung's Motion for Summary Judgment (Maroulis, Victoria) (Filed on 6/8/2012) (Entered: 06/08/2012)
- 06/08/2012 1071 Declaration of Bill Trac in Support of 1060 Administrative Motion to File Under Seal , 1061 Administrative Motion to File Under Seal Samsung's Reply In Support of Motion To Exclude Opinions of Certain of Apple's Experts , 1069 Administrative Motion to File Under Seal Exhibits to Trac Declaration in Support of Reply to Samsung's Motion for Summary Judgment , 1067 Administrative Motion to File Under Seal , 1063 Administrative Motion to File Under Seal Samsung's Reply in Support of Samsung's Motion for Summary Judgment filed by Samsung Electronics Co. Ltd.. (Related document(s) 1060 , 1061 , 1069 , 1067 , 1063 ) (Maroulis, Victoria) (Filed on 6/8/2012) (Entered: 06/08/2012)
- 06/08/2012 1072 CERTIFICATE OF SERVICE by Apple Inc. re 1056 Administrative Motion to File Under Seal Reply Declaration of Marc J. Pernick in Support of Apple's Motion to Strike Portions of Samsung's Expert Reports (Jacobs, Michael) (Filed on 6/8/2012) (Entered: 06/08/2012)
- 06/08/2012 1073 CERTIFICATE OF SERVICE by Apple Inc. re 1059 Administrative Motion to File Under Seal Apply's Reply to Samsung's Opposition to Apple's Motion to Exclude Opinions of Certain of Samsung's Experts (Jacobs, Michael) (Filed on 6/8/2012) (Entered: 06/08/2012)
- 06/08/2012 1074 Administrative Motion to File Under Seal filed by Samsung Electronics America, Inc.(a New York corporation), Samsung Electronics Co. Ltd., Samsung Telecommunications America, LLC(a Delaware limited liability company). (Attachments: # 1 Proposed Order Granting Motion to Seal, # 2 Declaration of Trevor Darrell in Support of Samsung's Motion to Strike Expert Testimony Based on Undisclosed Facts and Theories, # 3 Exhibit A to Darrell Declaration, # 4 Exhibit B to Darrell Declaration, # 5 Exhibit C to Darrell Declaration, # 6 Exhibit D to Darrell Declaration, # 7 Exhibit E to Darrell Declaration) (Maroulis, Victoria) (Filed on 6/8/2012) (Entered: 06/08/2012)
- 06/08/2012 1075 Declaration of Todd Briggs in Support of 1067 Administrative Motion to File Under Seal , 1074 Administrative Motion to File Under Seal filed by Samsung Electronics America, Inc. (a New York corporation), Samsung Electronics Co. Ltd., Samsung Telecommunications America, LLC(a Delaware limited liability company). (Related document(s) 1067 , 1074 ) (Maroulis, Victoria) (Filed on 6/8/2012) (Entered: 06/08/2012)
- 06/08/2012 1076 CERTIFICATE OF SERVICE by Samsung Electronics America, Inc.(a New York corporation), Samsung Electronics Co. Ltd., Samsung Telecommunications America, LLC (a Delaware limited liability company) re 999 Administrative Motion to File Under Seal (Maroulis, Victoria) (Filed on 6/8/2012) (Entered: 06/08/2012)
- 06/08/2012 1077 CERTIFICATE OF SERVICE by Samsung Electronics America, Inc.(a New York corporation), Samsung Electronics Co. Ltd., Samsung Telecommunications America, LLC (a Delaware limited liability company) re 1060 Administrative Motion to File Under Seal (Maroulis, Victoria) (Filed on 6/8/2012) (Entered: 06/08/2012)
- 06/08/2012 1078 CERTIFICATE OF SERVICE by Samsung Electronics America, Inc.(a New York corporation), Samsung Electronics Co. Ltd., Samsung Telecommunications America, LLC (a Delaware limited liability company) re 1067 Administrative Motion to File Under Seal , 1074 Administrative Motion to File Under Seal (Maroulis, Victoria) (Filed on 6/8/2012) (Entered: 06/08/2012)
- 06/11/2012 1079 OPPOSITION to Apple's Motion Pursuant to Rule 62(c) For Entry of Preliminary Injunction Without Further Hearing (Revised Redacted Version) by Samsung Electronics America, Inc.(a New York corporation), Samsung Telecommunications America, LLC(a Delaware limited liability company), Samsung Electronics Co. Ltd.. (Maroulis, Victoria) (Filed on

- 6/11/2012) Modified text on 6/12/2012 (dhm, COURT STAFF). (Entered: 06/11/2012)
- 06/11/2012 1080 MOTION to Remove Incorrectly Filed Document filed by Samsung Electronics America, Inc.(a New York corporation), Samsung Electronics Co. Ltd., Samsung Telecommunications America, LLC(a Delaware limited liability company). (Maroulis, Victoria) (Filed on 6/11/2012) (Entered: 06/11/2012)
- 06/11/2012 1081 REDACTION Samsung's Motion For Leave To Seek Reconsideration of the Court's May 21, 2012 Order (Revised Redacted Version) by Samsung Electronics America, Inc.(a New York corporation), Samsung Telecommunications America, LLC(a Delaware limited liability company), Samsung Electronics Co. Ltd.. (Maroulis, Victoria) (Filed on 6/11/2012) (Entered: 06/11/2012)
- 06/11/2012 1082 EXHIBITS to the Declaration of Thomas Watson In Support of Samsung's Motion For Leave To Seek Reconsideration of the Court's May 21, 2012 Order filed by Samsung Electronics America, Inc.(a New York corporation), Samsung Electronics Co. Ltd., Samsung Telecommunications America, LLC(a Delaware limited liability company). (Attachments: # 1 Exhibit 4, # 2 Exhibit 5, # 3 Exhibit 6, # 4 Exhibit 7, # 5 Exhibit 8, # 6 Exhibit 9, # 7 Exhibit 11, # 8 Exhibit 15)(Maroulis, Victoria) (Filed on 6/11/2012) (Entered: 06/11/2012)
- 06/12/2012 1083 Declaration of CYNDI WHEELER in Support of 1044 Administrative Motion to File Under Seal Samsung's Reply In Support of Motion For Clarification of May 4, 2012 Order filed by Apple Inc.. (Attachments: # 1 Exhibit A, # 2 Proposed Order)(Related document(s) 1044 ) (Jacobs, Michael) (Filed on 6/12/2012) (Entered: 06/12/2012)
- 06/12/2012 1084 Declaration of Daniel Shim in Support of 1047 Administrative Motion to File Under Seal Apple's Reply in Support of Motion for Adverse Inference Jury Instructions Due to Samsung's Spoliation of Evidence (Dkt. 895) filed by Samsung Electronics America, Inc.(a New York corporation), Samsung Electronics Co. Ltd., Samsung Telecommunications America, LLC(a Delaware limited liability company). (Related document(s) 1047 ) (Maroulis, Victoria) (Filed on 6/12/2012) (Entered: 06/12/2012)
- 06/12/2012 1085 MOTION to Strike 1040 Opposition to Notice of Motion for Clarification of April 12, 2012 Order, filed by Apple Inc.. Responses due by 6/26/2012. Replies due by 7/3/2012. (Bartlett, Jason) (Filed on 6/12/2012) Modified text on 6/13/2012 (dhm, COURT STAFF). (Entered: 06/12/2012)
- 06/12/2012 1086 Declaration of MIA MAZZA in Support of 1085 MOTION to Strike 1040 Opposition filed by Apple Inc.. (Attachments: # 1 Exhibit A, # 2 Exhibit B)(Related document(s) 1085 ) (Bartlett, Jason) (Filed on 6/12/2012) Modified text on 6/13/2012 (dhm, COURT STAFF). (Entered: 06/12/2012)
- 06/12/2012 1087 REPLY (re 965 Administrative Motion to File Under Seal Samsung's Motion to Enforce April 12, 2012 Order ) Samsung's Reply Brief In Support Of Motion To Enforce April 12 Order filed by Samsung Electronics America, Inc.(a New York corporation), Samsung Electronics Co. Ltd., Samsung Telecommunications America, LLC(a Delaware limited liability company). (Attachments: # 1 Declaration of Diane C. Hutnyan In Support of Motion to Enforce April 12 Order, # 2 Exhibit A to Reply Declaration of Diane C. Hutnyan In Support of Motion to Enforce April 12 Order, # 3 Exhibit B to Reply Declaration of Diane C. Hutnyan In Support of Motion to Enforce April 12 Order, # 4 Exhibit C to Reply Declaration of Diane C. Hutnyan In Support of Motion to Enforce April 12 Order, # 5 Exhibit D to Reply Declaration of Diane C. Hutnyan In Support of Motion to Enforce April 12 Order, # 6 Exhibit E to Reply Declaration of Diane C. Hutnyan In Support of Motion to Enforce April 12 Order)(Maroulis, Victoria) (Filed on 6/12/2012) (Entered: 06/12/2012)
- 06/12/2012 1088 Administrative Motion to File Under Seal filed by Samsung Electronics America, Inc., Samsung Electronics Co. Ltd., Samsung Telecommunications America, LLC. (Attachments: # 1 Proposed Order, # 2 Reply in Support of Motion for Rule 37 Sanctions, # 3 Reply Declaration of Diane C. Hutnyan, # 4 Exhibit 1, # 5 Exhibit 2, # 6 Exhibit 3, # 7 Exhibit 4, # 8 Exhibit 5, # 9 Exhibit 6, # 10 Exhibit 7, # 11 Exhibit 8, # 12 Exhibit 9, # 13 Exhibit 10, # 14 Exhibit 11, # 15 Exhibit 12, # 16 Exhibit 13)(Maroulis, Victoria) (Filed on 6/12/2012) (Entered: 06/12/2012)
- 06/12/2012 1089 Administrative Motion to File Under Seal filed by Apple Inc.. (Attachments: # 1 Declaration of Cyndi Wheeler, # 2 Proposed Order, # 3 [Public] Apple's Opening Design Patent Claim Construction Brief, # 4 Declaration of Mia Mazza, # 5 Exhibit 1, # 6 Exhibit 2, # 7 Errata 3, # 8 Exhibit 4, # 9 Exhibit 5, # 10 Exhibit 6 Part 1, # 11 Exhibit 6 Part 2, # 12 Exhibit 6 Part 3, # 13 Exhibit 6 Part 4, # 14 Exhibit 7 Part 1, # 15 Exhibit 7 Part 2, # 16 Exhibit 8, # 17 Exhibit 9, # 18 Exhibit 10, # 19 Exhibit 11, # 20 Exhibit 12, # 21 Exhibit 13)(Jacobs, Michael) (Filed on 6/12/2012) Modified on 6/13/2012. Pursuant to General Order No. 62, attachment #1 sealed (dhm, COURT STAFF). (Entered: 06/12/2012)

06/12/2012)

- 06/12/2012 1090 Administrative Motion to File Under Seal filed by Samsung Electronics America, Inc.(a New York corporation), Samsung Electronics Co. Ltd., Samsung Telecommunications America, LLC(a Delaware limited liability company). (Attachments: # 1 Samsung's Opening Claim Construction Memorandum)(Maroulis, Victoria) (Filed on 6/12/2012) (Entered: 06/12/2012)
- 06/13/2012 1091 Declaration of Adam S. Cashman in Support of 1090 Administrative Motion to File Under Seal filed by Samsung Electronics America, Inc.(a New York corporation), Samsung Electronics Co. Ltd., Samsung Telecommunications America, LLC(a Delaware limited liability company). (Attachments: # 1 Exhibit 1, # 2 Exhibit 2, # 3 Exhibit 3, # 4 Exhibit 5, # 5 Exhibit 6, # 6 Exhibit 7, # 7 Exhibit 8, # 8 Exhibit 9, # 9 Exhibit 10, # 10 Exhibit 11, # 11 Exhibit 12, # 12 Exhibit 13, # 13 Exhibit 16, # 14 Exhibit 21, # 15 Exhibit 22, # 16 Exhibit 23, # 17 Exhibit 24, # 18 Exhibit 26, # 19 Exhibit 27, # 20 Exhibit 28, # 21 Exhibit 29, # 22 Exhibit 30, # 23 Exhibit 31, # 24 Exhibit 32, # 25 Exhibit 33, # 26 Exhibit 34, # 27 Exhibit 35, # 28 Exhibit 36, # 29 Exhibit 37, # 30 Exhibit 38, # 31 Exhibit 39, # 32 Exhibit 40, # 33 Exhibit 41, # 34 Exhibit 42, # 35 Exhibit 43, # 36 Exhibit 44, # 37 Exhibit 45, # 38 Exhibit 46, # 39 Exhibit 47, # 40 Exhibit 48, # 41 Exhibit 49, # 42 Exhibit 50, # 43 Exhibit 51, # 44 Exhibit 52, # 45 Exhibit 53, # 46 Exhibit 54, # 47 Exhibit 55, # 48 Exhibit 56, # 49 Exhibit 57, # 50 Exhibit 58, # 51 Exhibit 59, # 52 Exhibit 60, # 53 Exhibit 61, # 54 Exhibit 62, # 55 Exhibit 63)(Related document(s) 1090 ) (Maroulis, Victoria) (Filed on 6/13/2012) (Entered: 06/13/2012)
- 06/13/2012 1092 CERTIFICATE OF SERVICE by Samsung Electronics America, Inc.(a New York corporation), Samsung Electronics Co. Ltd., Samsung Telecommunications America, LLC (a Delaware limited liability company) re 1090 Administrative Motion to File Under Seal , 1091 Declaration in Support,,,,, (Maroulis, Victoria) (Filed on 6/13/2012) (Entered: 06/13/2012)
- 06/13/2012 1093 Transcript of Proceedings held on March 27,2012, before Judge Paul S. Grewal. Court Reporter/Transcriber Christine Bedard, Telephone number (925) 548-2789. Per General Order No. 59 and Judicial Conference policy, this transcript may be viewed only at the Clerks Office public terminal or may be purchased through the Court Reporter/Transcriber until the deadline for the Release of Transcript Restriction.After that date it may be obtained through PACER. Any Notice of Intent to Request Redaction, if required, is due no later than 5 business days from date of this filing. Release of Transcript Restriction set for 9/11/2012. (mz, COURT STAFF) (Filed on 6/13/2012) (Entered: 06/13/2012)
- 06/13/2012 1094 CLERKS NOTICE CHANGING COURTROOM LOCATION FOR MOTION HEARING AND CASE MANAGEMENT CONFERENCE ON JUNE 21, 2012. THE MATTER WILL BE HEARD IN COURTROOM 1, FIFTH FLOOR. (mpb, COURT STAFF) (Filed on 6/13/2012) (Entered: 06/13/2012)
- 06/13/2012 1095 CERTIFICATE OF SERVICE by Samsung Electronics America, Inc., Samsung Electronics Co. Ltd., Samsung Telecommunications America, LLC (Maroulis, Victoria) (Filed on 6/13/2012) (Entered: 06/13/2012)
- 06/13/2012 1096 CERTIFICATE OF SERVICE by Apple Inc. re 1089 Administrative Motion to File Under Seal (Jacobs, Michael) (Filed on 6/13/2012) (Entered: 06/13/2012)

---

Copyright © 2012 LexisNexis CourtLink, Inc. All rights reserved.  
\*\*\* THIS DATA IS FOR INFORMATIONAL PURPOSES ONLY \*\*\*

**US District Court Civil Docket**

**U.S. District - Delaware  
(Wilmington)**

**1:10cv167**

**Apple Inc v. High Tech Computer Corp et al**

This case was retrieved from the court on Thursday, June 14, 2012

<b>Date Filed: 03/02/2010</b>	<b>Class Code: OPEN</b>
<b>Assigned To: Judge Gregory M Sleet</b>	<b>Closed: No</b>
<b>Referred To:</b>	<b>Statute: 35:271</b>
<b>Nature of suit: Patent (830)</b>	<b>Jury Demand: Both</b>
<b>Cause: Patent Infringement</b>	<b>Demand Amount: \$0</b>
<b>Lead Docket: None</b>	<b>NOS Description: Patent</b>
<b>Other Docket: 1:09-cv-00791-GMS</b>	
<b>1:09-cv-01002-GMS</b>	
<b>1:10-cv-00166-GMS</b>	
<b>1:10-cv-00544</b>	
<b>1:10-cv-00867-GMS</b>	
<b>1:11-cv-00611-GMS</b>	
<b>1:11-cv-00715-GMS</b>	
<b>1:11-cv-00785-GMS</b>	
<b>Jurisdiction: Federal Question</b>	

**Litigants**

Apple Inc  
Plaintiff

**Attorneys**

Richard K Herrmann  
[COR LD NTC]  
Morris James LLP  
500 Delaware Avenue, Suite 1500  
PO Box 2306  
Wilmington , DE 19899-2306  
USA  
(302) 888-6800  
Email: Rherrmann@morrisjames.com

Aaron Wainscoat  
[COR LD NTC]  
EMAIL: AARON.WAINSCOAT@DLAPIPER.COM  
<I>PRO HAC VICE</I>

Clayton Thompson  
[COR LD NTC]  
EMAIL: CTHOMPSON@FEINDAY.COM  
<I>PRO HAC VICE</I>

David L Alberti  
[COR LD NTC]  
EMAIL: DALBERTI@FEINDAY.COM  
<I>PRO HAC VICE</I>

Joseph A Loy  
[COR LD NTC]  
EMAIL: JOSEPH.LOY@KIRKLAND.COM  
<I>PRO HAC VICE</I>

Margaret Elizabeth Day  
[COR LD NTC]  
EMAIL: EDAY@FEINDAY.COM  
<I>PRO HAC VICE</I>

Melanie R Rupert  
[COR LD NTC]  
EMAIL: MELANIERUPERT@PAULHASTINGS.COM  
<I>PRO HAC VICE</I>

Michael Gulliford  
[COR LD NTC]  
EMAIL: MICHAEL.GULLIFORD@KIRKLAND.COM  
<I>PRO HAC VICE</I>

Robert A Appleby  
[COR LD NTC]  
EMAIL: ROBERT.APPLEBY@KIRKLAND.COM  
<I>PRO HAC VICE</I>

William C Mercer  
[COR LD NTC]  
EMAIL: WILLIAM.MERCER@KIRKLAND.COM  
<I>PRO HAC VICE</I>

Yakov Zolotorev  
[COR LD NTC]  
EMAIL: YZOLOTOREV@FEINDAY.COM  
<I>PRO HAC VICE</I>

High Tech Computer Corp Also Known as Htc Corp  
Defendant

Frederick L Cottrell , III  
[COR LD NTC]  
Richards, Layton & Finger, PA  
One Rodney Square  
920 N King Street  
Wilmington , DE 19801  
USA  
(302) 658-6541  
Email: COTTRELL@RLF.COM

Karen L Pascale  
[COR LD NTC]  
Young, Conaway, Stargatt & Taylor LLP  
Rodney Square  
1000 North King Street  
Wilmington , DE 19801  
USA  
(302) 571-6600  
Email: KPASCALE@YCST.COM

Ajay S Krishnan  
[COR LD NTC]  
EMAIL: AKRISHNAN@KVN.COM

<I>PRO HAC VICE</I>

Ashok Ramani  
[COR LD NTC]  
EMAIL: ARAMANI@KVN.COM  
<I>PRO HAC VICE</I>

Eugene M Paige  
[COR LD NTC]  
EMAIL: EPAIGE@KVN.COM  
<I>PRO HAC VICE</I>

John C Bostic  
[COR LD NTC]  
EMAIL: JBOSTIC@KVN.COM  
<I>PRO HAC VICE</I>

Leo L Lam  
[COR LD NTC]  
EMAIL: LLAM@KVN.COM  
<I>PRO HAC VICE</I>

Robert A Van Nest  
[COR LD NTC]  
EMAIL: RVANNEST@KVN.COM  
<I>PRO HAC VICE</I>

Sharif E Jacob  
[COR LD NTC]  
EMAIL: SJACOB@KVN.COM  
<I>PRO HAC VICE</I>

Stephen M Ferguson  
[COR LD NTC]  
Rawle & Henderson LLP  
300 Delaware Avenue  
Suite 1015  
PO Box 588  
Wilmington , DE 19899-0588  
USA  
302-657-2134  
Email: SFERGUSON@RAWLE.COM

Tyler R Bowen  
[COR LD NTC]  
EMAIL: TBOWEN@PERKINSCOIE.COM  
<I>PRO HAC VICE</I>

William S Hicks  
[COR LD NTC]  
EMAIL: WHICKS@KVN.COM  
<I>PRO HAC VICE</I>

John W Shaw  
[COR LD NTC]  
Shaw Keller LLP  
300 Delaware Avenue, Suite 1120  
Wilmington , DE 19801

USA  
(302) 298-0700  
Email: JSHAW@SHAWKELLER.COM

Htc (Bvi) Corp  
Defendant

Frederick L Cottrell , III  
[COR LD NTC]  
Richards, Layton & Finger, PA  
One Rodney Square  
920 N King Street  
Wilmington , DE 19801  
USA  
(302) 658-6541  
Email: COTTRELL@RLF.COM

Karen L Pascale  
[COR LD NTC]  
Young, Conaway, Stargatt & Taylor LLP  
Rodney Square  
1000 North King Street  
Wilmington , DE 19801  
USA  
(302) 571-6600  
Email: KPASCALE@YCST.COM

John W Shaw  
[COR LD NTC]  
Shaw Keller LLP  
300 Delaware Avenue, Suite 1120  
Wilmington , DE 19801  
USA  
(302) 298-0700  
Email: JSHAW@SHAWKELLER.COM

Htc America Inc  
Defendant

Frederick L Cottrell , III  
[COR LD NTC]  
Richards, Layton & Finger, PA  
One Rodney Square  
920 N King Street  
Wilmington , DE 19801  
USA  
(302) 658-6541  
Email: COTTRELL@RLF.COM

Karen L Pascale  
[COR LD NTC]  
Young, Conaway, Stargatt & Taylor LLP  
Rodney Square  
1000 North King Street  
Wilmington , DE 19801  
USA  
(302) 571-6600  
Email: KPASCALE@YCST.COM

David J Tsai  
[COR LD NTC]  
EMAIL: D TSAI@PERKINS COIE.COM  
<I>PRO HAC VICE</I>

Stephen M Ferguson  
[COR LD NTC]  
Rawle & Henderson LLP  
300 Delaware Avenue  
Suite 1015  
PO Box 588



Wilmington , DE 19899-0588  
USA  
302-657-2134  
Email: SFERGUSON@RAWLE.COM

John W Shaw  
[COR LD NTC]  
Shaw Keller LLP  
300 Delaware Avenue, Suite 1120  
Wilmington , DE 19801  
USA  
(302) 298-0700  
Email: JSHAW@SHAWKELLER.COM

Exedea Inc  
Defendant

Frederick L Cottrell , III  
[COR LD NTC]  
Richards, Layton & Finger, PA  
One Rodney Square  
920 N King Street  
Wilmington , DE 19801  
USA  
(302) 658-6541  
Email: COTTRELL@RLF.COM

Karen L Pascale  
[COR LD NTC]  
Young, Conaway, Stargatt & Taylor LLP  
Rodney Square  
1000 North King Street  
Wilmington , DE 19801  
USA  
(302) 571-6600  
Email: KPASCALE@YCST.COM

Stephen M Ferguson  
[COR LD NTC]  
Rawle & Henderson LLP  
300 Delaware Avenue  
Suite 1015  
PO Box 588  
Wilmington , DE 19899-0588  
USA  
302-657-2134  
Email: SFERGUSON@RAWLE.COM

John W Shaw  
[COR LD NTC]  
Shaw Keller LLP  
300 Delaware Avenue, Suite 1120  
Wilmington , DE 19801  
USA  
(302) 298-0700  
Email: JSHAW@SHAWKELLER.COM

Exedea Inc  
Counter Claimant

John W Shaw  
[COR LD NTC]  
Shaw Keller LLP  
300 Delaware Avenue, Suite 1120  
Wilmington , DE 19801  
USA  
(302) 298-0700  
Email: JSHAW@SHAWKELLER.COM

Htc (Bvi) Corp

John W Shaw

Counter Claimant

[COR LD NTC]  
Shaw Keller LLP  
300 Delaware Avenue, Suite 1120  
Wilmington , DE 19801  
USA  
(302) 298-0700  
Email: JSHAW@SHAWKELLER.COM

High Tech Computer Corp  
Counter Claimant

John W Shaw  
[COR LD NTC]  
Shaw Keller LLP  
300 Delaware Avenue, Suite 1120  
Wilmington , DE 19801  
USA  
(302) 298-0700  
Email: JSHAW@SHAWKELLER.COM

Htc America Inc  
Counter Claimant

John W Shaw  
[COR LD NTC]  
Shaw Keller LLP  
300 Delaware Avenue, Suite 1120  
Wilmington , DE 19801  
USA  
(302) 298-0700  
Email: JSHAW@SHAWKELLER.COM

Apple Inc  
Counter Defendant

Richard K Herrmann  
[COR LD NTC]  
Morris James LLP  
500 Delaware Avenue, Suite 1500  
PO Box 2306  
Wilmington , DE 19899-2306  
USA  
(302) 888-6800  
Email: Rherrmann@morrisjames.com

Melanie R Rupert  
[COR LD NTC]  
EMAIL: MELANIERUPERT@PAULHASTINGS.COM  
<I>PRO HAC VICE</I>

Apple Inc  
Counter Claimant

Richard K Herrmann  
[COR LD NTC]  
Morris James LLP  
500 Delaware Avenue, Suite 1500  
PO Box 2306  
Wilmington , DE 19899-2306  
USA  
(302) 888-6800  
Email: Rherrmann@morrisjames.com

Melanie R Rupert  
[COR LD NTC]  
EMAIL: MELANIERUPERT@PAULHASTINGS.COM  
<I>PRO HAC VICE</I>

High Tech Computer Corp  
Counter Defendant

Frederick L Cottrell , III  
[COR LD NTC]  
Richards, Layton & Finger, PA  
One Rodney Square

920 N King Street  
 Wilmington , DE 19801  
 USA  
 (302) 658-6541  
 Email: COTTRELL@RLF.COM

Karen L Pascale  
 [COR LD NTC]  
 Young, Conaway, Stargatt & Taylor LLP  
 Rodney Square  
 1000 North King Street  
 Wilmington , DE 19801  
 USA  
 (302) 571-6600  
 Email: KPASCALE@YCST.COM

Stephen M Ferguson  
 [COR LD NTC]  
 Rawle & Henderson LLP  
 300 Delaware Avenue  
 Suite 1015  
 PO Box 588  
 Wilmington , DE 19899-0588  
 USA  
 302-657-2134  
 Email: SFERGUSON@RAWLE.COM

Date	#	Proceeding Text	Source
03/02/2010	1	COMPLAINT filed with Jury Demand against Exedea Inc., HTC (BVI) Corp., HTC America Inc., High Tech Computer Corp. - Magistrate Consent Notice to Pltf. ( Filing fee \$ 350, receipt number 0311-700624.) - filed by Apple Inc.. (Attachments: # 1 Civil Cover Sheet, # 2 Exhibit A, # 3 Exhibit B, # 4 Exhibit B part 2, # 5 Exhibit C - F, # 6 Exhibit G - I, # 7 Exhibit J)(dab) (Entered: 03/03/2010)	
03/02/2010	2	Notice, Consent and Referral forms re: U.S. Magistrate Judge jurisdiction (dab) (Entered: 03/03/2010)	
03/02/2010	--	Summons Issued as to Exedea Inc. on 3/2/2010; HTC (BVI) Corp. on 3/2/2010; HTC America Inc. on 3/2/2010; High Tech Computer Corp. on 3/2/2010. (dab) (Entered: 03/03/2010)	
03/02/2010	3	Disclosure Statement pursuant to Rule 7.1 filed by Apple Inc. (dab) (Entered: 03/03/2010)	
03/03/2010	4	Report to the Commissioner of Patents and Trademarks for Patent/Trademark Number(s) 7,362,331 B2; 7,479,949 B2; 7,657,849 B2; 7,469,381 B2; 5,920,726; 7,633,076 B2; 5,848,105; 7,383,453 B2; 5,455,599; 6,424,354 (Attachments: # 1 Continuation of Report to Pat Comm) (dab) (Entered: 03/03/2010)	
03/10/2010	--	Case assigned to Judge Robert F. Kelly of the Eastern District of Pennsylvania (in lieu of Vacant Judgeship). Please include the initials of the Judge (RK) after the case number on all documents filed. (rjb) (Entered: 03/10/2010)	
03/24/2010	5	Letter to The Honorable Gregory M. Sleet from Richard K. Herrmann regarding related actions. (Herrmann, Richard) (Entered: 03/24/2010)	
03/31/2010	6	MOTION for Extension of Time to File Answer re 1 Complaint, - filed by Exedea Inc., HTC (BVI) Corp., HTC America Inc., High Tech Computer Corp.. (Attachments: # 1 Text of Proposed Order)(Cottrell, Frederick) (Entered: 03/31/2010)	
03/31/2010	7	AFFIDAVIT of Service for Complaint served on HTC America, Inc. and High Tech Computer Corp. a/k/a HTC Corp. on March 9, 2010 and March 16, 2010 respectively, filed by Apple Inc.. (Herrmann, Richard) (Entered: 03/31/2010)	
04/05/2010	--	SO ORDERED, re 6 MOTION for Extension of Time to File Answer - Set/Reset Answer Deadlines: Exedea Inc. answer due 5/21/2010; HTC (BVI) Corp. answer due 5/21/2010; HTC America Inc. answer due 5/21/2010; High Tech Computer Corp. answer due 5/21/2010. Signed by Judge Robert F. Kelly on 4/1/10. (rwc) (Entered: 04/05/2010)	
04/09/2010	8	MOTION to Transfer Case to United States District Court for the Northern District	

California - filed by Exedea Inc., HTC America Inc., High Tech Computer Corp..  
 (Attachments: # 1 Text of Proposed Order, # 2 Certificate of Compliance 7.1.1  
 Certification)(Ferguson, Stephen) (Entered: 04/09/2010)

- 04/09/2010 9 OPENING BRIEF in Support re 8 MOTION to Transfer Case to United States District Court for the Northern District California filed by Exedea Inc., HTC America Inc., High Tech Computer Corp.. Answering Brief/Response due date per Local Rules is 4/26/2010. (Ferguson, Stephen) (Entered: 04/09/2010)
- 04/09/2010 10 DECLARATION re (8 in 1:10-cv-00167-RK, 8 in 1:10-cv-00166-RK) MOTION to Transfer Case to United States District Court for the Northern District California, (9 in 1:10-cv-00166-RK) Opening Brief in Support, (9 in 1:10-cv-00167-RK) Opening Brief in Support, (Declaration of Brian Ong) by Exedea Inc., HTC America Inc., High Tech Computer Corp.. (Ferguson, Stephen) (Entered: 04/09/2010)
- 04/09/2010 11 DECLARATION re (8 in 1:10-cv-00167-RK, 8 in 1:10-cv-00166-RK) MOTION to Transfer Case to United States District Court for the Northern District California, (9 in 1:10-cv-00166-RK) Opening Brief in Support, (9 in 1:10-cv-00167-RK) Opening Brief in Support, (Declaration of Andrew Rubin) by Exedea Inc., HTC America Inc., High Tech Computer Corp.. (Ferguson, Stephen) (Entered: 04/09/2010)
- 04/09/2010 12 DECLARATION re (8 in 1:10-cv-00167-RK, 8 in 1:10-cv-00166-RK) MOTION to Transfer Case to United States District Court for the Northern District California, (9 in 1:10-cv-00166-RK) Opening Brief in Support, (9 in 1:10-cv-00167-RK) Opening Brief in Support, (Declaration of Jason Mackenzie) by Exedea Inc., HTC America Inc., High Tech Computer Corp.. (Ferguson, Stephen) (Entered: 04/09/2010)
- 04/09/2010 13 DECLARATION re (8 in 1:10-cv-00167-RK, 8 in 1:10-cv-00166-RK) MOTION to Transfer Case to United States District Court for the Northern District California, (9 in 1:10-cv-00166-RK) Opening Brief in Support, (9 in 1:10-cv-00167-RK) Opening Brief in Support, (Declaration of Ellison Wada) by Exedea Inc., HTC America Inc., High Tech Computer Corp.. (Attachments: # 1 Exhibit 1, # 2 Exhibit 2 - Part 1, # 3 Exhibit 2 - Part 2, # 4 Exhibit 3, # 5 Exhibit 4, # 6 Exhibit 5, # 7 Exhibit 6, # 8 Exhibit 7, # 9 Exhibit 8, # 10 Exhibit 9, # 11 Exhibit 10, # 12 Exhibit 11, # 13 Exhibit 12, # 14 Exhibit 13, # 15 Exhibit 14, # 16 Exhibit 15, # 17 Exhibit 16, # 18 Exhibit 17, # 19 Exhibit 18, # 20 Exhibit 19, # 21 Exhibit 20, # 22 Exhibit 21, # 23 Exhibit 22, # 24 Exhibit 23, # 25 Exhibit 24, # 26 Exhibit 25, # 27 Exhibit 26, # 28 Exhibit 27, # 29 Exhibit 28, # 30 Exhibit 29, # 31 Exhibit 30, # 32 Exhibit 31, # 33 Exhibit 32, # 34 Exhibit 33, # 35 Exhibit 34, # 36 Exhibit 35, # 37 Exhibit 36, # 38 Exhibit 37, # 39 Exhibit 38, # 40 Exhibit 39, # 41 Exhibit 40, # 42 Exhibit 41, # 43 Exhibit 42, # 44 Exhibit 43, # 45 Exhibit 44, # 46 Exhibit 45, # 47 Exhibit 46, # 48 Exhibit 47)(Ferguson, Stephen) (Entered: 04/09/2010)
- 04/15/2010 14 NOTICE OF SUBSTITUTION OF COUNSEL re Exedea Inc., HTC (BVI) Corp., HTC America Inc., High Tech Computer Corp.: Entry of appearance of attorney Karen L. Pascale. Attorney (1) Frederick L. Cottrell, III and (2) Stephen M. Ferguson terminated. (Pascale, Karen) (Entered: 04/15/2010)
- 04/23/2010 15 STIPULATION and Proposed Order on Motion to Transfer by Exedea Inc., HTC (BVI) Corp., HTC America Inc., High Tech Computer Corp.. (Pascale, Karen) (Entered: 04/23/2010)
- 05/12/2010 16 JOINDER by HTC (BVI) Corp., joining in (8 in 1:10-cv-00167-RK, 8 in 1:10-cv-00166-RK) Motion to Transfer Case,. (Pascale, Karen) (Entered: 05/12/2010)
- 05/14/2010 17 Joint MOTION for Extension of Time to (1) respond to complaint and (2) respond to motion to transfer venue - filed by Apple Inc., Exedea Inc., HTC (BVI) Corp., HTC America Inc., High Tech Computer Corp., NeXT Software Inc.. (Herrmann, Richard) (Entered: 05/14/2010)
- 05/17/2010 18 SO ORDERED, re (19 in 1:10-cv-00166-RK, 17 in 1:10-cv-00167-RK) Joint MOTION for Extension of Time to (1) respond to complaint and (2) respond to motion to transfer venue . Signed by Judge Robert F. Kelly on 5/17/10. Associated Cases: 1:10-cv-00166-RK, 1:10-cv-00167-RK(ntl) (Entered: 05/17/2010)
- 05/17/2010 -- Reset Answer Deadlines: Exedea Inc. answer due 6/4/2010; HTC (BVI) Corp. answer due 6/4/2010; HTC America Inc. answer due 6/4/2010; High Tech Computer Corp. answer due 6/4/2010 PER D.I. 18. (ntl) (Entered: 05/17/2010)
- 05/24/2010 19 MOTION to Consolidate Cases 09-791; 09-1002; 10-166; and 10-167 - filed by Apple Inc.. (Herrmann, Richard) (Entered: 05/24/2010)
- 05/24/2010 20 OPENING BRIEF in Support re 19 MOTION to Consolidate Cases 09-791; 09-1002; 10-166; and 10-167 filed by Apple Inc.. Answering Brief/Response due date per Local Rules

- is 6/10/2010. (Herrmann, Richard) (Entered: 05/24/2010)
- 05/24/2010 21 DECLARATION re 19 MOTION to Consolidate Cases 09-791; 09-1002; 10-166; and 10-167 by Apple Inc.. (Herrmann, Richard) (Entered: 05/24/2010)
- 05/24/2010 22 SEALED ANSWERING BRIEF in Opposition re 8 MOTION to Transfer Case to United States District Court for the Northern District California Pursuant to 28 U.S.C. Section 1404 filed by Apple Inc.. Reply Brief due date per Local Rules is 6/4/2010. (Herrmann, Richard) (Entered: 05/24/2010)
- 05/24/2010 23 SEALED DECLARATION re 22 Answering Brief in Opposition, to Motion Pursuant to 28 U.S.C. Section 1404 to Transfer Venue to the Northern District of California by Apple Inc.. (Herrmann, Richard) (Entered: 05/24/2010)
- 05/25/2010 -- NOTICE RE COURTESY COPIES: Please note that in cases assigned to Visiting Judges, courtesy copies of electronically filed documents - (OVER 50 PAGES) - should be sent to the chambers of the Visiting Judge unless otherwise directed. The courtesy copies of documents not filed electronically should also be sent to the chambers of the Visiting Judge. The originals of the non-electronic documents (sealed documents, oversized documents, etc.) should be filed in the Clerks Office in the District of Delaware. (rwc) (Entered: 05/25/2010)
- 06/02/2010 24 MOTION for Extension of Time to File 1) Reply Brief in Support of Defendants' Motion to Transfer Venue [D.I. 8 in C.A. No. 10-166-RK and D.I. 8 in C.A. No. 10-167-RK] and 2) Opposition to Plaintiffs' Motion for Consolidation [D.I. 21 in C.A. No. 10-166-RK and D.I. 19 in C.A. No. 10-167-RK] - UNOPPOSED - filed by Exedea Inc., HTC (BVI) Corp., HTC America Inc., High Tech Computer Corp.. (Attachments: # 1 Text of Proposed Order) (Pascale, Karen) (Entered: 06/02/2010)
- 06/03/2010 25 SO ORDERED - Motion for Extension of Time. Signed by Judge Robert F. Kelly on 6/3/10. (rwc) (Entered: 06/03/2010)
- 06/04/2010 -- REDACTION NOTICE: In accordance with section G of the Administrative Procedures Governing Filing and Service by Electronic Means, redacted versions of sealed documents shall be filed electronically within 7 days of the filing of the sealed document. The records of this case do not reflect the filing of a redacted version of (DI # 24,25 in CA 10-166 RK & DI # 22,23 in CA 10-167 RK) Associated Cases: 1:10-cv-00166-RK, 1:10-cv-00167-RK(rwc) (Entered: 06/04/2010)
- 06/04/2010 26 MOTION to Dismiss for Failure to State a Claim - Motion to Dismiss Count VIII of Complaint Pursuant to Rule 12(b)(6) - filed by Exedea Inc., HTC (BVI) Corp., HTC America Inc., High Tech Computer Corp.. (Attachments: # 1 Text of Proposed Order) (Pascale, Karen) (Entered: 06/04/2010)
- 06/04/2010 27 OPENING BRIEF in Support re 26 MOTION to Dismiss for Failure to State a Claim - Motion to Dismiss Count VIII of Complaint Pursuant to Rule 12(b)(6) MOTION to Dismiss for Failure to State a Claim - Motion to Dismiss Count VIII of Complaint Pursuant to Rule 12(b)(6) filed by Exedea Inc., HTC (BVI) Corp., HTC America Inc., High Tech Computer Corp.. Answering Brief/Response due date per Local Rules is 6/21/2010. (Pascale, Karen) (Entered: 06/04/2010)
- 06/04/2010 28 STATEMENT re 26 MOTION to Dismiss for Failure to State a Claim - Motion to Dismiss Count VIII of Complaint Pursuant to Rule 12(b)(6) MOTION to Dismiss for Failure to State a Claim - Motion to Dismiss Count VIII of Complaint Pursuant to Rule 12(b)(6) , 27 Opening Brief in Support, - REQUEST FOR JUDICIAL NOTICE IN SUPPORT OF MOTION TO DISMISS COUNT VIII OF COMPLAINT PURSUANT TO RULE 12(b)(6) - by Exedea Inc., HTC (BVI) Corp., HTC America Inc., High Tech Computer Corp.. (Attachments: # 1 Exhibit A, # 2 Exhibit B-H)(Pascale, Karen) (Entered: 06/04/2010)
- 06/07/2010 29 REDACTED VERSION of (24 in 1:10-cv-00166-RK) Answering Brief in Opposition, (22 in 1:10-cv-00167-RK) Answering Brief in Opposition, to Motion to Transfer by Apple Inc.. (Herrmann, Richard) (Entered: 06/07/2010)
- 06/07/2010 30 DECLARATION re (23 in 1:10-cv-00167-RK) Declaration, (25 in 1:10-cv-00166-RK) Declaration of Richard Herrmann by Apple Inc.. (Herrmann, Richard) (Entered: 06/07/2010)
- 06/09/2010 31 SEALED REPLY BRIEF re 8 MOTION to Transfer Case to United States District Court for the Northern District California filed by Exedea Inc., HTC (BVI) Corp., HTC America Inc., High Tech Computer Corp.. (Pascale, Karen) (Entered: 06/09/2010)
- 06/09/2010 32 SEALED DECLARATION re 31 Reply Brief - Declaration of Karen L. Pascale - by Exedea Inc., HTC (BVI) Corp., HTC America Inc., High Tech Computer Corp.. (Attachments: # 1 Exhibit 1-9-FILED UNDER SEAL)(Pascale, Karen) (Entered: 06/09/2010)

- 06/14/2010 33 REQUEST for Oral Argument by Exedea Inc., HTC (BVI) Corp., HTC America Inc., High Tech Computer Corp. re 8 MOTION to Transfer Case to United States District Court for the Northern District California. (Pascale, Karen) (Entered: 06/14/2010)
- 06/18/2010 34 REDACTED VERSION of (31 in 1:10-cv-00167-RK) Reply Brief, (30 in 1:10-cv-00166-RK) Reply Brief in Support of Motion to Transfer Case to United States District Court for the Northern District California by HTC (BVI) Corp., HTC America Inc., High Tech Computer Corp., Exedea Inc.. (Pascale, Karen) (Entered: 06/18/2010)
- 06/18/2010 35 REDACTED VERSION of (32 in 1:10-cv-00167-RK) Declaration, (31 in 1:10-cv-00166-RK) Declaration of Karen L. Pascale - by Exedea Inc., HTC (BVI) Corp., HTC America Inc., High Tech Computer Corp.. (Attachments: # 1 Exhibit 1-9)(Pascale, Karen) (Entered: 06/18/2010)
- 06/21/2010 36 MOTION to Defer Oral Argument on Pending Motion to Transfer - filed by Apple Inc., NeXT Software Inc.. (Herrmann, Richard) (Entered: 06/21/2010)
- 06/21/2010 37 PROPOSED ORDER granting Plaintiffs' Motion to Defer Oral Argument on Pending Motion to Transfer re (35 in 1:10-cv-00166-RK, 36 in 1:10-cv-00167-RK) MOTION to Defer Oral Argument on Pending Motion to Transfer by Apple Inc., NeXT Software Inc.. (Herrmann, Richard) (Entered: 06/21/2010)
- 06/21/2010 38 First AMENDED COMPLAINT against Exedea Inc., HTC (BVI) Corp., HTC America Inc., High Tech Computer Corp.- filed by Apple Inc.. (Attachments: # 1 Exhibit A, # 2 Exhibit B part 1, # 3 Exhibit B part 2, # 4 Exhibit C-E, # 5 Exhibit F, # 6 Exhibit G-H) (Herrmann, Richard) (Entered: 06/21/2010)
- 06/21/2010 39 ANSWERING BRIEF in Opposition re 26 MOTION to Dismiss for Failure to State a Claim - Motion to Dismiss Count VIII of Complaint Pursuant to Rule 12(b)(6) MOTION to Dismiss for Failure to State a Claim - Motion to Dismiss Count VIII of Complaint Pursuant to Rule 12(b)(6) filed by Apple Inc..Reply Brief due date per Local Rules is 7/1/2010. (Herrmann, Richard) (Entered: 06/21/2010)
- 06/21/2010 40 PROPOSED ORDER Deny as Moot - Motion to Dismiss re 26 MOTION to Dismiss for Failure to State a Claim - Motion to Dismiss Count VIII of Complaint Pursuant to Rule 12(b)(6) MOTION to Dismiss for Failure to State a Claim - Motion to Dismiss Count VIII of Complaint Pursuant to Rule 12(b)(6) by Apple Inc.. (Herrmann, Richard) (Entered: 06/21/2010)
- 06/21/2010 41 ANSWERING BRIEF in Opposition re 19 MOTION to Consolidate Cases 09-791; 09-1002; 10-166; and 10-167 filed by Exedea Inc., HTC (BVI) Corp., HTC America Inc., High Tech Computer Corp..Reply Brief due date per Local Rules is 7/1/2010. (Pascale, Karen) (Entered: 06/21/2010)
- 06/21/2010 42 DECLARATION re 41 Answering Brief in Opposition, - Declaration of Karen L. Pascale - by Exedea Inc., HTC (BVI) Corp., HTC America Inc., High Tech Computer Corp.. (Attachments: # 1 Exhibit 1-3)(Pascale, Karen) (Entered: 06/21/2010)
- 06/21/2010 43 RESPONSE to Motion re 36 MOTION to Defer Oral Argument on Pending Motion to Transfer filed by Exedea Inc., HTC (BVI) Corp., HTC America Inc., High Tech Computer Corp.. (Pascale, Karen) (Entered: 06/21/2010)
- 06/23/2010 44 ORDER granting 36 Motion to Defer Oral Argument on Pending Motion to Transfer. Oral argument on the pending Motion to Transfer is deferred until the Court has ruled on Plaintiffs' Motion for Consolidation. Signed by Judge Robert F. Kelly on 6/23/10. (fms) (Entered: 06/23/2010)
- 06/23/2010 45 MOTION for Pro Hac Vice Appearance of Attorney Robert A. Appleby, Attorney Melanie R. Rupert and Attorney Ryan H. Coletti - filed by Apple Inc.. (Herrmann, Richard) (Entered: 06/23/2010)
- 06/25/2010 -- SO ORDERED, re 45 MOTION for Pro Hac Vice Appearance of Attorney Robert A. Appleby, Attorney Melanie R. Rupert and Attorney Ryan H. Coletti filed by Apple Inc. Signed by Judge Robert F. Kelly on 6/25/10. (ntl) (Entered: 06/28/2010)
- 06/28/2010 46 NOTICE of Withdrawal of Motion to Dismiss Count VIII of Complaint (D.I. 26) Without Prejudice Due to Mootness by Exedea Inc., HTC (BVI) Corp., HTC America Inc., High Tech Computer Corp. re 26 MOTION to Dismiss for Failure to State a Claim - Motion to Dismiss Count VIII of Complaint Pursuant to Rule 12(b)(6) MOTION to Dismiss for Failure to State a Claim - Motion to Dismiss Count VIII of Complaint Pursuant to Rule 12(b)(6) (Pascale, Karen) (Entered: 06/28/2010)
- 07/01/2010 47 REPLY BRIEF re 19 MOTION to Consolidate Cases 09-791; 09-1002; 10-166; and 10-167 filed by Apple Inc.. (Herrmann, Richard) (Entered: 07/01/2010)

- 07/06/2010 48 ANSWER to Amended Complaint ANSWER to 38 Amended Complaint, with Jury Demand, COUNTERCLAIM against Apple Inc. by Exedea Inc., HTC (BVI) Corp., High Tech Computer Corp., HTC America Inc.. (Attachments: # 1 Exhibit A, # 2 Exhibit B, # 3 Exhibit C) (Shaw, John) (Entered: 07/06/2010)
- 07/08/2010 -- Case reassigned to Judge Gregory M. Sleet. Please include the initials of the Judge (GMS) after the case number on all documents filed. Associated Cases: 1:10-cv-00166-GMS, 1:10-cv-00167-GMS(rjb) (Entered: 07/08/2010)
- 07/13/2010 49 MOTION for Pro Hac Vice Appearance of Attorney Steven Cherny - filed by Apple Inc.. (Herrmann, Richard) (Entered: 07/13/2010)
- 07/21/2010 -- SO ORDERED, re 49 MOTION for Pro Hac Vice Appearance of Attorney Steven Cherny filed by Apple Inc. Ordered by Chief Judge Gregory M. Sleet on 7/21/2010. (asw) (Entered: 07/21/2010)
- 07/29/2010 50 MOTION for Pro Hac Vice Appearance of Attorney James E. Marina - filed by Apple Inc.. (Herrmann, Richard) (Entered: 07/29/2010)
- 07/30/2010 51 ANSWER to 48 Answer to Amended Complaint, Counterclaim,,, COUNTERCLAIM against High Tech Computer Corp. by Apple Inc..(Herrmann, Richard) (Entered: 07/30/2010)
- 07/30/2010 52 MOTION for Pro Hac Vice Appearance of Attorney Mark D. Fowler, Attorney M. Elizabeth Day, Attorney David L. Alberti and Attorney Yakov Zolotorev - filed by Apple Inc.. (Herrmann, Richard) (Entered: 07/30/2010)
- 08/04/2010 -- SO ORDERED, re 50 MOTION for Pro Hac Vice Appearance of Attorney James E. Marina filed by Apple Inc., 52 MOTION for Pro Hac Vice Appearance of Attorney Mark D. Fowler, Attorney M. Elizabeth Day, Attorney David L. Alberti and Attorney Yakov Zolotorev filed by Apple Inc. Ordered by Chief Judge Gregory M. Sleet on 8/4/10. (mmm) (Entered: 08/04/2010)
- 08/05/2010 53 MOTION for Pro Hac Vice Appearance of Attorney Clayton Thompson - filed by Apple Inc.. (Herrmann, Richard) (Entered: 08/05/2010)
- 08/05/2010 -- SO ORDERED, re 53 MOTION for Pro Hac Vice Appearance of Attorney Clayton Thompson filed by Apple Inc. Ordered by Chief Judge Gregory M. Sleet on 8/5/2010. (asw) (Entered: 08/05/2010)
- 08/23/2010 54 ANSWER to 51 Answer to Counterclaim, [High Tech Computer Corp.'s a/k/a HTC Corp.'s Reply to Apple Inc.'s Counter-Counterclaims] by High Tech Computer Corp..(Pascale, Karen) (Entered: 08/23/2010)
- 09/14/2010 55 NOTICE requesting Clerk to remove Melanie Rupert as co-counsel. Reason for request: no longer with Kirkland & Ellis. (Herrmann, Richard) (Entered: 09/14/2010)
- 09/17/2010 -- Pro Hac Vice Attorney Robert A. Appleby for Apple Inc., and for NeXT Software Inc. added for electronic noticing. Associated Cases: 1:10-cv-00166-GMS, 1:10-cv-00167-GMS, 1:10-cv-00544-GMS(nms) (Entered: 09/17/2010)
- 09/27/2010 -- Pro Hac Vice Attorney Robert A. Appleby for Apple Inc. added for electronic noticing. (els) (Entered: 09/27/2010)
- 12/06/2010 56 ORDER denying (47) Motion to Consolidate Cases in case 1:09-cv-00791-GMS; denying (17) Motion to Consolidate Cases in case 1:09-cv-01002-GMS; denying (19) Motion to Consolidate Cases in case 1:10-cv-00167-GMS; denying (21) Motion to Consolidate Cases in case 1:10-cv-00166-GMS. Signed by Chief Judge Gregory M. Sleet on 12/6/2010. (asw) (Entered: 12/06/2010)
- 12/16/2010 57 MOTION for Pro Hac Vice Appearance of Attorney Gregory S. Arovos of the law firm of Kirkland & Ellis LLP - filed by Apple Inc., NeXT Software Inc.. (Herrmann, Richard) (Entered: 12/16/2010)
- 01/05/2011 58 MOTION for Pro Hac Vice Appearance of Attorney William C. Mercer - filed by Apple Inc., NeXT Software Inc.. (Herrmann, Richard) (Entered: 01/05/2011)
- 01/14/2011 59 MEMORANDUM AND ORDER DENYING (8 in 1:10-cv-00167-GMS, 8 in 1:10-cv-00166-GMS) MOTION to Transfer Case to United States District Court for the Northern District California filed by Exedea Inc., HTC America Inc., High Tech Computer Corp. Signed by Chief Judge Gregory M. Sleet on 1/14/2011. (asw) (Entered: 01/14/2011)
- 01/25/2011 -- SO ORDERED, re 57 MOTION for Pro Hac Vice Appearance of Attorney Gregory S. Arovos of the law firm of Kirkland & Ellis LLP filed by NeXT Software Inc., Apple Inc.. Signed by Judge Gregory M. Sleet on 1/25/2011. (nms) (Entered: 01/25/2011)
- 01/25/2011 -- SO ORDERED, re 58 MOTION for Pro Hac Vice Appearance of Attorney William C. Mercer

- filed by NeXT Software Inc., Apple Inc.. Signed by Judge Gregory M. Sleet on 1/25/2011. (nms) (Entered: 01/25/2011)
- 06/15/2011 60 NOTICE of Change of Law Firm by Apple Inc. (Herrmann, Richard) (Entered: 06/15/2011)
- 06/21/2011 -- Pro Hac Vice Attorneys David L. Alberti, Yakov Zolotorev, and M. Elizabeth Day for Apple Inc. added for electronic noticing. (nms) (Entered: 06/21/2011)
- 07/01/2011 61 NOTICE OF SERVICE of Apple's First Set of Interrogatories to Defendants and Apple's First Set of Requests for the Production of Documents by Apple Inc..(Herrmann, Richard) (Entered: 07/01/2011)
- 07/05/2011 62 NOTICE OF SERVICE of Defendants' First Set of Interrogatories and Defendants' First Set of Requests for Production of Documents and Things by HTC (BVI) Corp., HTC America Inc., High Tech Computer Corp., Exedea Inc..(Pascale, Karen) (Entered: 07/05/2011)
- 07/06/2011 -- Pro Hac Vice Attorney Clayton Thompson for Apple Inc. added for electronic noticing. (nms) (Entered: 07/06/2011)
- 07/13/2011 63 MOTION for Pro Hac Vice Appearance of Attorney Erik R. Fuehrer and Aaron Wainscoat - filed by Apple Inc.. (Herrmann, Richard) (Entered: 07/13/2011)
- 07/14/2011 -- SO ORDERED, re 63 MOTION for Pro Hac Vice Appearance of Attorney Erik R. Fuehrer and Aaron Wainscoat filed by Apple Inc. Ordered by Chief Judge Gregory M. Sleet on 7/13/2011. (asw) (Entered: 07/14/2011)
- 07/29/2011 64 NOTICE of Change of Address (of Keker & Van Nest LLP) by Exedea Inc., HTC America Inc., High Tech Computer Corp. (Shaw, John) (Entered: 07/29/2011)
- 07/29/2011 65 NOTICE OF SERVICE of Defendants High Tech Computer Corp., A/K/A HTC Corp., HTC America, Inc. and Exedea, Inc.'s Initial Disclosures Pursuant to Rule 26 of the Federal Rules of Civil Procedure by HTC (BVI) Corp., HTC America Inc., High Tech Computer Corp., Exedea Inc..(Shaw, John) (Entered: 07/29/2011)
- 07/29/2011 66 NOTICE OF SERVICE of Initial Disclosures Pursuant to Fed. R. Civ. P. 26(a)(1)(A) by Apple Inc..(Herrmann, Richard) (Entered: 07/29/2011)
- 08/02/2011 67 MOTION to Stay - - (Incorporating D. Del. LR. 7.1.1 Statement) - filed by HTC (BVI) Corp., HTC America Inc., High Tech Computer Corp., Exedea Inc., HTC America Holding Inc.. (Attachments: # 1 Proposed Order)(Pascale, Karen) (Entered: 08/02/2011)
- 08/02/2011 68 OPENING BRIEF in Support re 67 MOTION to Stay - - (Incorporating D. Del. LR. 7.1.1 Statement) filed by Exedea Inc., HTC (BVI) Corp., HTC America Inc., High Tech Computer Corp..Answering Brief/Response due date per Local Rules is 8/19/2011. (Pascale, Karen) (Entered: 08/02/2011)
- 08/05/2011 69 NOTICE OF SERVICE of Apple's Objections and Responses to HTC's First Set of Interrogatories and Apple's Objections and Responses to HTC's First Set of Requests for Production of Documents and Things on August 4, 2011 by Apple Inc..(Herrmann, Richard) (Entered: 08/05/2011)
- 08/08/2011 70 NOTICE OF SERVICE of (1) Responses and Objections to Apple's First Set of Interrogatories to Defendants and (2) Defendants HTC Corp., HTC America, Inc. and Exedea, Inc.'s Responses to Apple's First Set of Requests for the Production of Documents by Exedea Inc., HTC America Inc., High Tech Computer Corp..(Pascale, Karen) (Entered: 08/08/2011)
- 08/19/2011 71 ANSWERING BRIEF in Opposition re 67 MOTION to Stay - - (Incorporating D. Del. LR. 7.1.1 Statement) Apple's Opposition to HTC's Motion to Stay filed by Apple Inc..Reply Brief due date per Local Rules is 8/29/2011. (Herrmann, Richard) (Entered: 08/19/2011)
- 08/29/2011 72 REPLY BRIEF re 67 MOTION to Stay - - (Incorporating D. Del. LR. 7.1.1 Statement) filed by Exedea Inc., HTC (BVI) Corp., HTC America Inc., High Tech Computer Corp.. (Pascale, Karen) (Entered: 08/29/2011)
- 09/28/2011 73 MOTION for Pro Hac Vice Appearance of Attorney Michael J. Gulliford - filed by Apple Inc., NeXT Software Inc.. (Herrmann, Richard) (Entered: 09/28/2011)
- 10/03/2011 74 Joint STATUS REPORT by Apple Inc., Exedea Inc., HTC (BVI) Corp., HTC America Inc., High Tech Computer Corp.. (Herrmann, Richard) (Entered: 10/03/2011)
- 10/11/2011 -- SO ORDERED, re (36 in 1:10-cv-00544-GMS, 51 in 1:10-cv-00166-GMS, 73 in 1:10-cv-00167-GMS) MOTION for Pro Hac Vice Appearance of Attorney Michael J. Gulliford filed by NeXT Software Inc., Apple Inc. Ordered by Chief Judge Gregory M. Sleet on 10/11/2011. (asw) (Entered: 10/11/2011)



- 10/17/2011 75 NOTICE OF SERVICE of Defendants' Disclosure of Asserted Claims and Preliminary Infringement Contentions by Exedea Inc., HTC (BVI) Corp., HTC America Inc., High Tech Computer Corp..(Shaw, John) (Entered: 10/17/2011)
- 10/17/2011 76 NOTICE OF SERVICE of Supplemental Responses to HTC's First Set of Interrogatories (Nos. 1-4) by Apple Inc..(Herrmann, Richard) (Entered: 10/17/2011)
- 10/30/2011 77 NOTICE of Withdrawal of Certain Counsel and Change of Firm Affiliation of Remaining Counsel by Exedea Inc., HTC (BVI) Corp., HTC America Inc., High Tech Computer Corp. (Pascale, Karen) (Entered: 10/30/2011)
- 11/08/2011 78 MOTION for Pro Hac Vice Appearance of Attorney Joseph A. Loy, Attorney Andrew G. Heinz and Attorney Todd M. Friedman - filed by Apple Inc., NeXT Software Inc.. (Herrmann, Richard) (Entered: 11/08/2011)
- 11/08/2011 -- SO ORDERED, re 78 MOTION for Pro Hac Vice Appearance of Attorney Joseph A. Loy, Attorney Andrew G. Heinz and Attorney Todd M. Friedman filed by NeXT Software Inc., Apple Inc. Ordered by Chief Judge Gregory M. Sleet on 11/8/2011. (asw) (Entered: 11/08/2011)
- 11/08/2011 79 NOTICE of Depositions and Subpoenas to Nokia, Inc, Kyocera Wireless Corp., Ericsson, Inc., Research In Motion Corp., and Analog Devices, Inc. by Apple Inc. (Herrmann, Richard) (Entered: 11/08/2011)
- 11/18/2011 80 NOTICE of Deposition and Subpoena to Media Tek USA, Inc. by Apple Inc. (Herrmann, Richard) (Entered: 11/18/2011)
- 11/18/2011 81 SUBPOENA Returned Executed as to Research In Motion Corp. on November 3, 2011 (Herrmann, Richard) (Entered: 11/18/2011)
- 11/18/2011 82 SUBPOENA Returned Executed as to Analog Devices, Inc. on November 3, 2011 (Herrmann, Richard) (Entered: 11/18/2011)
- 11/23/2011 83 NOTICE of Depositions and Subpoenas for Amkor Technology, Inc., BNN Technologies, Corp., Intel Corporation, Massachusetts Institute of Technology, Sony-Ericsson Mobile Communications (USA) Inc. and Tessera Technologies, Inc. by Apple Inc. (Herrmann, Richard) (Entered: 11/23/2011)
- 11/30/2011 84 NOTICE of Depositions and Subpoenas by Apple Inc. (Herrmann, Richard) (Entered: 11/30/2011)
- 12/05/2011 85 NOTICE to Take Deposition of Rule 30(b)(6) deponent for Hewlett Packard Company on December 22, 2011 at 9:00 a.m. by Apple Inc.. (Attachments: # 1 Exhibit A)(Haney, Megan) (Entered: 12/05/2011)
- 12/05/2011 86 NOTICE of Depositions and Subpoenas by Apple Inc. (Herrmann, Richard) (Entered: 12/05/2011)
- 12/06/2011 87 NOTICE of Depositions and Subpoenas by Apple Inc. (Herrmann, Richard) (Entered: 12/06/2011)
- 12/06/2011 88 NOTICE of Service of Defendants' Second Set of Interrogatories by Exedea Inc., HTC (BVI) Corp., HTC America Inc., High Tech Computer Corp. (Shaw, John) (Entered: 12/06/2011)
- 12/09/2011 89 MOTION for Pro Hac Vice Appearance of Attorney Ryan J. McBrayer, Kaustuv M. Das, David J. Tsai and Tyler R. Bowen - filed by Exedea Inc., HTC (BVI) Corp., HTC America Inc., High Tech Computer Corp.. (Shaw, John) (Entered: 12/09/2011)
- 12/09/2011 90 NOTICE OF SERVICE of Second Set of Requests for the Production of Documents by Apple Inc..(Herrmann, Richard) (Entered: 12/09/2011)
- 12/13/2011 -- Pro Hac Vice Attorney Michael Gulliford, Joseph A. Loy for Apple Inc. added for electronic noticing. Associated Cases: 1:10-cv-00544-GMS, 1:10-cv-00166-GMS, 1:10-cv-00167-GMS(els) (Entered: 12/13/2011)
- 12/14/2011 -- Pro Hac Vice Attorney William C. Mercer for Apple Inc., William C. Mercer for Apple Inc., William C. Mercer for Apple Inc. added for electronic noticing. Associated Cases: 1:10-cv-00166-GMS, 1:10-cv-00167-GMS, 1:10-cv-00544-GMS(rbe) (Entered: 12/14/2011)
- 12/15/2011 91 NOTICE of Depositions and Subpoenas by Apple Inc. (Herrmann, Richard) (Entered: 12/15/2011)
- 12/15/2011 92 Letter to The Honorable Gregory M. Sleet from Richard K. Herrmann regarding Joint Status Report and Scheduling Conference. (Herrmann, Richard) (Entered: 12/15/2011)

- 12/15/2011 93 Amended STATUS REPORT by Apple Inc., Exedea Inc., HTC (BVI) Corp., HTC America Inc., High Tech Computer Corp.. (Herrmann, Richard) (Entered: 12/15/2011)
- 12/16/2011 94 MOTION for Pro Hac Vice Appearance of Attorney Robert A. Van Nest, Leo L. Lam, Ashok Ramani, Eugene M. Paige, Ajay S. Kirshnan, John C. Bostic, William S. Hicks and Sharif E. Jacob - filed by Exedea Inc., HTC (BVI) Corp., HTC America Inc., High Tech Computer Corp.. (Shaw, John) (Entered: 12/16/2011)
- 12/16/2011 -- SO ORDERED, re 89 MOTION for Pro Hac Vice Appearance of Attorney Ryan J. McBrayer, Kaustuv M. Das, David J. Tsai and Tyler R. Bowen filed by Exedea Inc., HTC America Inc., High Tech Computer Corp., HTC (BVI) Corp. Ordered by Chief Judge Gregory M. Sleet on 12/16/2011. (asw) (Entered: 12/16/2011)
- 12/16/2011 -- SO ORDERED, re 94 MOTION for Pro Hac Vice Appearance of Attorney Robert A. Van Nest, Leo L. Lam, Ashok Ramani, Eugene M. Paige, Ajay S. Kirshnan, John C. Bostic, William S. Hicks and Sharif E. Jacob filed by Exedea Inc., HTC America Inc., High Tech Computer Corp., HTC (BVI) Corp. Ordered by Chief Judge Gregory M. Sleet on 12/16/2011. (asw) (Entered: 12/16/2011)
- 12/20/2011 -- Pro Hac Vice Attorney Leo L. Lam, Ashok Ramani, John C. Bostic, Ajay S. Krishnan, Sharif E. Jacob, Robert A. Van Nest, Eugene M. Paige, William S. Hicks for High Tech Computer Corp. added for electronic noticing. (dmp, ) (Entered: 12/20/2011)
- 12/21/2011 95 MOTION for Pro Hac Vice Appearance of Attorney Christina J. McCullough - filed by HTC (BVI) Corp., HTC America Inc., High Tech Computer Corp., Exedea Inc.. (Shaw, John) (Entered: 12/21/2011)
- 12/21/2011 -- Pro Hac Vice Attorney Aaron Wainscoat for Apple Inc. added for electronic noticing. (dmp, ) (Entered: 12/21/2011)
- 12/21/2011 -- SO ORDERED, re (95 in 1:10-cv-00167-GMS, 47 in 1:10-cv-00544-GMS) MOTION for Pro Hac Vice Appearance of Attorney Christina J. McCullough filed by Exedea Inc., HTC America Inc., High Tech Computer Corp., HTC (BVI) Corp. Ordered by Chief Judge Gregory M. Sleet on 12/21/2011. (asw) (Entered: 12/21/2011)
- 12/21/2011 96 NOTICE OF SERVICE of First Supplemental Responses and Objections To Apple's Interrogatory Nos. 1 & 8 by Exedea Inc., HTC (BVI) Corp., HTC America Inc., High Tech Computer Corp.. (Shaw, John) (Entered: 12/21/2011)
- 12/22/2011 97 ORDER granting (67) Motion to Stay in case 1:10-cv-00167-GMS; granting (30) Motion to Stay in case 1:10-cv-00544-GMS; granting (11) Motion to Stay in case 1:11-cv-00611-GMS. Signed by Chief Judge Gregory M. Sleet on 12/22/2011. (asw) (Entered: 12/22/2011)
- 01/09/2012 -- Pro Hac Vice Attorney David J. Tsai for HTC America Inc. added for electronic noticing. (rbe) (Entered: 01/09/2012)
- 01/17/2012 -- Pro Hac Vice Attorney Tyler R. Bowen for High Tech Computer Corp. added for electronic noticing. (dmp, ) (Entered: 01/17/2012)



Switch Client | Preferences | Help | Sign Out

<b>My Lexis™</b>	<b>Search</b> ▾	<b>Get a Document</b> ▾	<b>Shepard's®</b> ▾	<b>More</b> ▾	<b>History</b>
					<b>Alerts</b>

**FOCUS™** Terms  Search Within   Using  
 Semantic Concepts What's this? [Advanced...](#)

[View Tutorial](#)

Source: **Command Searching > Utility, Design and Plant Patents**

Terms: **7469381** (Suggest Terms for My Search)

Select for FOCUS™ or Delivery

- 1. 8174504, May 8, 2012, Input device and method for adjusting a parameter of an electronic system, Arthur, Kevin, San Jose, California, United States of America (US), United States of America(); Mason, III, William R., Apots, California, United States of America(US), United States of America(); Day, Shawn P., San Jose, California, United States of America(US), United States of America(); 391011, February 23, 2009, ASSIGNMENT OF ASSIGNORS INTEREST (SEE DOCUMENT FOR DETAILS)., SYNAPTICS INCORPORATED, 3120 SCOTT BLVD. SUITE 130, SANTA CLARA, CALIFORNIA, UNITED STATES OF AMERICA(US), 95054, reel-frame:022297/0881, Synaptics Incorporated, Santa Clara, California, United States of America(US), United States company or corporation

**CORE TERMS:** input, sensing, region, parameter, circle, path, measurement, interface, sensor, adjustment, electronic system, processing, descriptive, user, proximity, transition, detect, change in position, magnitude, turning, display, depicted, implemented, detecting, segment, detected, arcuate, media, moving, linear

... 7138983, November 21, 2006, Wakai et al., United States of America (US) **7469381**, December 23, 2008, Ording, United States of America (US) 20050046621, March 3, ...

- 2. 8174503, May 8, 2012, Touch-based authentication of a mobile device through user generated pattern creation, Chin, David H., Menlo Park, California, United States of America(US), United States of America(); 122667, Cain, David H., Menlo Park, California, United States of America(US), United States individual

**CORE TERMS:** gesture, mobile, module, tactile, user, unlocking, touchscreen, transform, memory, telephonic communication, region, touch, screen, unlocked, profile, stored, unlock, visual aid, designated, media, processor, browser, tolerance, locked, emergency, keypad, input, circuitry, message, transformed

... 7411575, August 12, 2008, Hill et al., United States of America (US) **7469381**, December 23, 2008, Ording, United States of America (US) 7479949, January 20, ...

- 3. 8139059, March 20, 2012, Object illumination in a virtual environment, Trepte, Forrest, Redmond, Washington, United States of America(US), United States of America(); 278264, April 5, 2006, ASSIGNMENT OF ASSIGNORS INTEREST (SEE DOCUMENT FOR DETAILS)., MICROSOFT CORPORATION, ONE MICROSOFT WAY,

REDMOND, WASHINGTON, UNITED STATES OF AMERICA(US), 98052, reel-frame:017424/0036, Microsoft Corporation, Redmond, Washington, United States of America(US), United States company or corporation

**CORE TERMS:** display, input, screen, virtual, computer, camera, pixel, computing, user, light source, shadow, cube, sensor, ambient, map, game, displayed, processing, detected, memory, interface, remote, media, monitor, video, real world, brightness, detection, storage, modules

... July 8, 2008, Robbins et al., United States of America (US), 345#173 **7469381**, December 23, 2008, Ording, United States of America (US) 7483015, January 27,

...

- 4. 8125458, February 28, 2012, Detecting finger orientation on a touch-sensitive device, Keam, Nigel, Redmond, Washington, United States of America(US), United States of America(); 864650, September 28, 2007, ASSIGNMENT OF ASSIGNORS INTEREST (SEE DOCUMENT FOR DETAILS)., MICROSOFT CORPORATION, ONE MICROSOFT WAY, REDMOND, WASHINGTON, UNITED STATES OF AMERICA(US), 98052, reel-frame:019898/0516, Microsoft Corporation, Redmond, Washington, United States of America(US), United States company or corporation

**CORE TERMS:** region, display, touch, intensity, screen, threshold, touch-sensitive, finger, orientation, user, layer, pixel, configured, capture, touching, optical, capacitive, resistive, sumv, controller, detected, correspond, computing, detect, calculated, input, sumvx, sumvy, subject matter, touch-sensing

... States of America (US) 7136514, November 14, 2006, Wong, United States of America (US) **7469381**, December 23, 2008, Ording, United States of America (US), 715#702 20020030668, March ...

- 5. 8106856, January 31, 2012, Portable electronic device for photo management, Matas, Michael, Palo Alto, California, United States of America(US), United States of America(); Christie, Greg, San Jose, California, United States of America(US), United States of America(); Marcos, Paul D., Los Altos, California, United States of America(US), United States of America(); Forstall, Scott, Mountain View, California, United States of America(US), United States of America(); Van Os, Marcel, San Francisco, California, United States of America(US), United States of America(); Ording, Bas, San Francisco, California, United States of America(US), United States of America(); Chaudhri, Imran, San Francisco, California, United States of America (US), United States of America(); 848210, May 15, 2008, ASSIGNMENT OF ASSIGNORS INTEREST (SEE DOCUMENT FOR DETAILS)., APPLE INC., 1 INFINITE LOOP, CUPERTINO, CALIFORNIA, UNITED STATES OF AMERICA(US), 95014, reel-frame:020956/0307, Apple Inc., Cupertino, California, United States of America (US), United States company or corporation

**CORE TERMS:** user, display, touch, portable, screen, electronic device, gesture, icon, digital, interface, finger, displayed, module, thumbnail, camera, detecting, button, input, album, photo, photographic, memory, scrolling, initiate, wheel, video, activated, keyboard, email, controller

... States of America (US) 7164410, January 16, 2007, Kupka, United States of America (US) **7469381**, December 23, 2008, Ording, United States of America (US) 7786975, August 31, ...

- 6. 8073931, December 6, 2011, Networked touchscreen with integrated interfaces, Dawes, Paul J., Woodside, California, United States of America(US), United States of America(US); Fulker, Jim, Palo Alto, California, United States of America(US), United States of America(US); Wales, Carolyn, Menlo Park, California, United States of America(US), United States of America(US); 197895, November 24, 2008, ASSIGNMENT OF ASSIGNORS INTEREST (SEE DOCUMENT FOR DETAILS)., ICONTROL NETWORKS, INC., 3045 PARK BLVD., 2ND FLOOR, PALO ALTO, CALIFORNIA, UNITED STATES OF AMERICA(US), 94306, reel-frame:021884/0346, iControl Networks, Inc., Redwood City, California, United States of America(US), United States company or corporation

**CORE TERMS:** security system, network, gateway, touchscreen, interface, integrated, user, coupled, server, sensor, panel, camera, installer, remote, wireless, engine, web, protocol, widget, manager, manage, provider, video, processor, broadband, installation, internet, coupling, customer, functionality

... 7262690, August 28, 2007, Heaton et al., United States of America (US) **7469381**, December 23, 2008, Ording, United States of America (US) 7479949, January 20, ...

- 7. 8001613, August 16, 2011, Security using physical objects, Duncan, Camano Island, Washington, United States of America(US), United States of America(); 426101, June 28, 2006, ASSIGNMENT OF ASSIGNORS INTEREST (SEE DOCUMENT FOR DETAILS)., MICROSOFT CORPORATION, ONE MICROSOFT WAY, REDMOND, WASHINGTON, UNITED STATES OF AMERICA(US), 98052, reel-frame:017855/0564, Microsoft Corporation, Redmond, Washington, United States of America(US), United States company or corporation

**CORE TERMS:** display, user, computer, emsp, detected, outline, computing, interface, media, orientation, placement, memory, input, storage, monitor, modules, remote, granularity, television, processing, password, interior, video, bus, disk drive, rotation, optical, detect, camera, touch

... 7397464, July 8, 2008, Robbins et al., United States of America (US) **7469381**, December 23, 2008, Ording, United States of America (US) 7483015, January 27, ...

- 8. 7612786, November 3, 2009, Variable orientation input mode, Vale, Peter O., Redmond, WASHINGTON, United States of America(US), United States of America (US); Duncan, Camano Island, WASHINGTON, United States of America(US), United States of America(US); 350853, February 28, 2006, ASSIGNMENT OF ASSIGNORS INTEREST (SEE DOCUMENT FOR DETAILS)., MICROSOFT CORPORATION, ONE MICROSOFT WAY, REDMOND, WASHINGTON, UNITED STATES OF AMERICA(US), 98052, reel-frame:017616/0386, Microsoft Corporation, Redmond, WASHINGTON, United States of America(US), United States company or corporation

**CORE TERMS:** display, user's, computer, input, finger, sequence, memory, interface, virtual, stylus, computing, media, screen, automatically, timer, gesture, storage, select, modules, touch, orientation, processing, displayed, touching, monitor, swipe, bus, disk drive, remote, video

... 7327376, February 5, 2008, Shen et al., United States of America (US) **7469381**, December 23, 2008, Ording, United States of America (US) 7843015,

November 30, ...

- 9. 7469381, July 10, 2008, List scrolling and document translation, scaling, and rotation on a touch-screen display, Ording, Bas, San Francisco, CALIFORNIA , United States of America(US), United States of America(US); 956969, August 15, 2008, ASSIGNMENT OF ASSIGNORS INTEREST (SEE DOCUMENT FOR DETAILS)., APPLE INC. 1 INFINITE LOOP CUPERTINO CALIFORNIA 95014, reel-frame:021397/0743, Apple Inc., Cupertino, CALIFORNIA , United States of America (US), United States company or corporation

**CORE TERMS:** display, screen, touch, displayed, electronic, gesture, user, module, magnification, rotation, near, scrolling, detecting, detected, interface, web, portable, terminus, memory, predefined, icon, input, displaying, email, digital, finger, multifunction, controller, touch-sensitive, translation

**7469381**

- 10. 5261266, November 16, 1993, Sensor tip for a robotic gripper and method of manufacture, Lorenz, Robert D., Madison, United States of America(US); Jackson, Gregory T., Madison, United States of America(US); 849660, Wisconsin Alumni Research Foundation, Madison, Wisconsin, United States of America(US)

**CORE TERMS:** transducer, sub, sensor, tip, film, linear, driver, piezoelectric, polymer, elastomeric, tangential, amplifier, slide, mold, constant, feedback, strain, torque, coil, capacitance, robotic, distal, cavity, robot, ratio, silicone rubber, matrix, wire, resistance, capacitor

January 24, 1990 - **07469381**, United States of America (US) ; January 14, 1991 - 07640638, United States of America (US)

---

Source: **Command Searching > Utility, Design and Plant Patents** 

Terms: **7469381** (Suggest Terms for My Search)

View: Cite

Date/Time: Thursday, June 14, 2012 - 10:33 AM EDT

---



**LexisNexis**<sup>®</sup>

About LexisNexis | Privacy Policy | Terms & Conditions | Contact Us  
Copyright © 2012 LexisNexis, a division of Reed Elsevier Inc. All rights reserved.



Switch Client | Preferences | Help | Sign Out

My Lexis™ Search Get a Document Shepard's® More History Alerts

All Legal News & Business Public Records Find A Source + Add/Edit Subtabs

Command Searching > Patent Cases from Federal Courts and Administrative Materials **i**

**Search** View Tutorial | Help

**Select Search Type and Enter Search Terms**

<b>Terms &amp; Connectors</b>	7469381 or 7,469,381	Suggest terms for my search
Natural Language		Check spelling
Easy Search™		

**Search**

**Restrict by Document Segment**

Select a document segment, enter search terms for the segment, then click Add.

Select a Segment  **Add**

**Note:** Segment availability differs between sources. Segments may not be applied consistently across sources.

**Restrict by Date**

No Date Restrictions  From  To  Date formats...

---

<p><b>Search Connectors</b></p> <p>and    and                    w/p    in same paragraph</p> <p>or     or                         w/seg  in same segment</p> <p>w/N    within N words            w/s    in same sentence</p> <p>pre/N  precedes by N words    and not and not</p> <p>More Connectors &amp; Commands...</p>	<p><b>How Do I...?</b></p> <p>Combine sources?</p> <p>Restrict by date?</p> <p>Restrict by document segment?</p> <p>Use wildcards as placeholders for one or more characters in a search term?</p> <p>View Tutorials</p>
---	--

My Lexis™ Search Get a Document Shepard's® More History Alerts

FOCUS™ Terms: 7469381 or 7,469,381 Search Within: Original Results (1 - 5) Go View Tutorial

Source: **Command Searching > Patent Cases from Federal Courts and Administrative Materials**

Terms: **7469381 or 7,469,381** (Suggest Terms for My Search)

Select for FOCUS™ or Delivery

- 1. Apple, Inc. v. Samsung Elecs. Co., 2012-1105, UNITED STATES COURT OF APPEALS FOR THE FEDERAL CIRCUIT, 2012 U.S. App. LEXIS 9720, May 14, 2012, Decided

**OVERVIEW:** Patents at issue pertained to smartphones and tablet computers. Patent owner appealed from denial of a preliminary injunction. As to three of the four patents at issue in this appeal, the patent owner did not satisfy its burden of demonstrating an abuse of discretion. As to fourth patent, district court committed legal error requiring remand.

**CORE TERMS:** patent, irreparable harm, tablet, preliminary injunction, injunction, front, infringement, smartphone, injunctive relief, screen ...

... shows the following: Apple has also asserted U.S. Patent No. **7,469,381** ("the '381 patent"), a utility patent that claims a software ...

- 2. Apple, Inc. v. Samsung Elecs. Co., Case No.: 11-CV-01846-LHK, UNITED STATES DISTRICT COURT FOR THE NORTHERN DISTRICT OF CALIFORNIA, SAN JOSE DIVISION, 2012 U.S. Dist. LEXIS 48055, April 4, 2012, Decided, April 4, 2012, Filed, Motion granted by, in part, Motion granted by Apple Inc. v. Samsung Elecs. Co., 2012 U.S. Dist. LEXIS 48011 (N.D. Cal., Apr. 4, 2012)

**CORE TERMS:** window, specification, embodiment, user, electronic, display, applet, cursor, ellipse, edge ...

... CONSTRUING DISPUTED CLAIM TERMS OF U.S. PATENT NOS. 7,698,711; 6,493,002; **7,469,381**; 7,663,607; 7,812,828; 7,844,915; and 7,853,891 Plaintiff Apple brings this suit ...

... suit: U.S. Patent Nos. 7,698,711 ("711 Patent"); 6,493,002 ("002 Patent"); **7,469,381** ("381 Patent"); 7,663,607 ("607 Patent"); 7,812,828 ("828 Patent"); 7,844,915 ("915 Patent") ...

- 3. Apple Inc. v. Samsung Elecs. Co., Civil Action No. 11-CV-01846-LHK, UNITED STATES DISTRICT COURT FOR THE NORTHERN DISTRICT OF CALIFORNIA, SAN JOSE DIVISION, 2012 U.S. Dist. LEXIS 49201, January 30, 2012, Decided, January 30, 2012, Filed, Motion granted by, in part Apple Inc. v. Samsung Elecs. Co., 2012 U.S. App. LEXIS 2511 (Fed. Cir., Feb. 8, 2012)

**OVERVIEW:** Pursuant to Fed. R. Civ. P. 26(c), a magistrate judge found good cause to enter an agreed upon protective order regarding the disclosure and use of



discovery materials, including materials related to pertinent patent applications and depositions and other testimony related to any protected materials.

**CORE TERMS:** producing, confidential, discovery, protective order, disclosure, designation, designated, outside counsel, deposition, electronic ...

... c) "Patents-in-suit" means U.S. Patents Nos. 7,812,828; 6,493,002; **7,469,381**; 7,844,915; 7,853,891; 7,663,607; 7,864,163; 7,920,129; D627,790; D617,334; D604,305; D593,087; D618,677; D622,270 ...

-  4. Apple, Inc. v. Samsung Elecs. Co., Case No.: 11-CV-01846-LHK, UNITED STATES DISTRICT COURT FOR THE NORTHERN DISTRICT OF CALIFORNIA, SAN JOSE DIVISION, 2011 U.S. Dist. LEXIS 139049, December 2, 2011, Decided, December 2, 2011, Filed, Motion granted by Apple Inc. v. Samsung Elecs. Co., 2011 U.S. App. LEXIS 25163 (Fed. Cir., Dec. 16, 2011) Motion granted by, in part, Motion denied by, in part Apple Inc. v. Samsung Elecs. Co., 2011 U.S. Dist. LEXIS 147515 (N.D. Cal., Dec. 22, 2011) Affirmed in part and vacated in part by, Remanded by Apple, Inc. v. Samsung Elecs. Co., 2012 U.S. App. LEXIS 9720 (Fed. Cir., May 14, 2012)

**CORE TERMS:** patent, infringement, screen, preliminary injunction, irreparable harm, tablet, front, prior art, display, user ...

... because these products infringe upon Apple's United States Patent No. **7,469,381** ("the '381 patent"). See id. After hearing oral argument on ...

-  5. Nokia Corp. v. Apple Inc., C.A. No. 09-791-GMS, UNITED STATES DISTRICT COURT FOR THE DISTRICT OF DELAWARE, 2011 U.S. Dist. LEXIS 58773, June 1, 2011, Decided

**CORE TERMS:** counterclaim, reexamination, patent, judicial estoppel, discovery, patent infringement, scheduled, citations omitted, injunctive relief, pari delicto ...

... '795 patent"), 5,315,703 ("the '703 patent"), 6,189,034 B1 ("the '034 patent"), **7,469,381** B2 ("the '381 patent"), 5,455,854 ("the '854 patent"), 7,383,453 B2 (" ...







Source: **Command Searching > Patent Cases from Federal Courts and Administrative Materials** 

Terms: **7469381 or 7,469,381** (Suggest Terms for My Search)

View: Cite

Date/Time: Thursday, June 14, 2012 - 10:34 AM EDT

\* Signal Legend:

-  - Warning: Negative treatment is indicated
-  - Questioned: Validity questioned by citing refs
-  - Caution: Possible negative treatment
-  - Positive treatment is indicated
-  - Citing Refs. With Analysis Available
-  - Citation information available

\* Click on any *Shepard's* signal to *Shepardize*® that case.



About LexisNexis | Privacy Policy | Terms & Conditions | Contact Us  
Copyright © 2012 LexisNexis, a division of Reed Elsevier Inc. All rights reserved.



Switch Client | Preferences | Help | Sign Out

My Lexis™ Search Get a Document Shepard's® More History Alerts

All Legal News & Business Public Records Find A Source + Add/Edit Subtabs

Command Searching > Patent, Trademark & Copyright Periodicals, Combined [i](#)

[View Tutorial](#) | [Help](#)

**Search**

**Select Search Type and Enter Search Terms**

<b>Terms &amp; Connectors</b>	7469381 or 7,469,381	Suggest terms for my search
Natural Language		Check spelling
Easy Search™		

**Restrict by Document Segment**

Select a document segment, enter search terms for the segment, then click Add.

Select a Segment

**Note:** Segment availability differs between sources. Segments may not be applied consistently across sources.

**Restrict by Date**

No Date Restrictions   From  To  Date formats...

---

<p><b>Search Connectors</b></p> <p>and    and                    w/p    in same paragraph</p> <p>or     or                         w/seg in same segment</p> <p>w/N    within N words         w/s    in same sentence</p> <p>pre/N precedes by N words    and not    and not</p> <p><a href="#">More Connectors &amp; Commands...</a></p>	<p><b>How Do I...?</b></p> <p><a href="#">Combine sources?</a></p> <p><a href="#">Restrict by date?</a></p> <p><a href="#">Restrict by document segment?</a></p> <p><a href="#">Use wildcards as placeholders for one or more characters in a search term?</a></p> <p><a href="#">View Tutorials</a></p>
---	--

**No Documents Found**

No documents were found for your search terms  
**"7469381 or 7,469,381"**

Click "Save this search as an Alert" to schedule your search to run in the future.

- OR -

Click "Search Using Natural Language" to run your search as Natural Language search.

- OR -

Click "Edit Search" to return to the search form and modify your search.

Suggestions:

- Check for spelling errors.
- Remove some search terms.
- Use more common search terms, such as those listed in "Suggested Words and Concepts."
- Use a less restrictive date range.
- Use "OR" in between terms to search for one term or the other.

[Save this Search as an Alert](#) | [Search Using Natural Language](#) | [Edit Search](#)

MyLexis™ Search - Get a Document Shepard's® More History Alerts

All Legal News & Business Public Records Find A Source + Add/Edit Subtabs

Command Searching > News, All (English, Full Text) ⓘ

View Tutorial | Help

**Search**

**Select Search Type and Enter Search Terms**

Terms & Connectors	7469381 or 7,469,381	Suggest terms for my search <input type="button" value="Search"/>  Check spelling
Natural Language		
Easy Search™		

**Restrict by Document Segment**

Select a document segment, enter search terms for the segment, then click Add.

Select a Segment

**Note:** Segment availability differs between sources. Segments may not be applied consistently across sources.

**Restrict by Date**

No Date Restrictions   From  To  Date formats...

---

<p><b>Search Connectors</b></p> <p>and    and                    w/p    in same paragraph</p> <p>or     or                            w/seg  in same segment</p> <p>w/N    within N words            w/s    in same sentence</p> <p>pre/N  precedes by N words    and not and not</p> <p>More Connectors &amp; Commands...</p>	<p><b>How Do I...?</b></p> <p>Combine sources?</p> <p>Restrict by date?</p> <p>Restrict by document segment?</p> <p>Use wildcards as placeholders for one or more characters in a search term?</p> <p>View Tutorials</p>
--	--

My Lexis™ Search Get a Document Shepard's® More History Alerts

FOCUS™ Terms  Search Within   View Tutorial

Source: **Command Searching > News, All (English, Full Text)**

Terms: **7469381 or 7,469,381** (Suggest Terms for My Search)

Select for FOCUS™ or Delivery

- 1. Patent Law Practice Center, May 31, 2012 Thursday 5:38 AM EST, , 802 words, Anonymous Attack on Facebook s User News Feed Patent Among the Reexamination Requests Filed the Week of May 21, 2012  
  
**CORE TERMS:** patent, entitled, electronically, Samsung, reexamination, infringement, method, ObjectVideo, Facebook, ITC, litigation, styled, Motorola, Yahoo!, N.D, requested, sued, feed, ex parte, inter partes, et al, ENGINE, MobileMedia, APPARATUS, SEARCH, E.D, HTC, screen, pixel, touch  
  
... 22, 2012. (5) 90/012,304 (electronically filed) U.S. Patent No. **7,469,381** entitled LIST SCROLLING AND DOCUMENT TRANSLATION, SCALING, AND ROTATION ON A TOUCH- ...
- 2. Targeted News Service, May 29, 2012 Tuesday 4:09 AM EST, , 493 words, U.S. International Trade Commission Issues Notice Regarding Certain Portable Electronic Devices and Related Software, Targeted News Service, WASHINGTON  
  
**CORE TERMS:** International Trade Commission, notice, patent, motion, Tariff Act, initial determination, Barton, Acting, Lisa, S.W, ALJ, U.S.C, HTC, determination, determined, unopposed, terminate, asserted, obtained, amended, usitc, http, edis, gov  
  
... by reason of the infringement of claims of U.S. Patent Nos. 7,844,915 ("the '915 patent"); **7,469,381**; 7,084,859; 7,920,129; and 6,956,564. 76 Fed. Reg. 50253 (Aug. 12, 2011). The ...
- 3. US Fed News, May 29, 2012 Tuesday 8:36 PM EST, , 374 words, USITC ISSUES NOTICE REGARDING CERTAIN PORTABLE ELECTRONIC DEVICES AND RELATED SOFTWARE  
  
**CORE TERMS:** notice, International Trade Commission, patent, usitc, http, gov, initial determination, S.W, HTC, asserted, obtained, viewed, edis, www, fed, reg  
  
... by reason of the infringement of claims of U.S. Patent Nos. 7,844,915 ("the '915 patent"); **7,469,381**; 7,084,859; 7,920,129; and 6,956,564. 76 Fed. Reg. 50253 (Aug. 12, 2011). The ...
- 4. VR-Zone, May 29, 2012 Tuesday 11:21 PM EST, , 34 words, Apple's multitouch patents under attack



- 9. PC Magazine.com, September 24, 2011 Saturday 6:12 PM EST, , CELL PHONES, 503 words, Verizon Fights Apple's Preliminary Injunction vs. Samsung, David Murphy david\_murphy@pcmag.com

**CORE TERMS:** Verizon's, Samsung, patent, LTE, preliminary injunction, motion, Wireless, Galaxy, injunction, dispute, adopters, argues, enemy

... scrolling through information on a touchscreen display, or U.S. Patent No. **7,469,381**. "The claims of the '381 patent are so clear that in recent litigation between Apple and ...

- 10. Targeted News Service, August 30, 2011 Tuesday 3:47 AM EST, , 512 words, U.S. International Trade Commission Issues Notice Regarding Certain Portable Electronic Devices and Related Software, Targeted News Service, WASHINGTON

**CORE TERMS:** International Trade Commission, complaint, notice, target date, determination, importation, United States, electronic devices, administrative law judge's, Holbein, S.W, ALJ, HTC, determined, portable, obtained, setting, alleged, usitc, http, edis, gov

... 12, 2011). The complaint alleged the infringement of claims of U.S. Patent Nos. 7,844,915; **7,469,381**; 7,084,859; 7,920,129; and 6,956,564. The complaint named as respondents HTC Corp. of Taiwan and its subsidiaries ...

---

Source: **Command Searching > News, All (English, Full Text)** 

Terms: **7469381 or 7,469,381** (Suggest Terms for My Search)

View: Cite

Date/Time: Thursday, June 14, 2012 - 10:34 AM EDT

---



About LexisNexis | Privacy Policy | Terms & Conditions | Contact Us  
 Copyright © 2012 LexisNexis, a division of Reed Elsevier Inc. All rights reserved.





UNITED STATES PATENT AND TRADEMARK OFFICE

UNITED STATES DEPARTMENT OF COMMERCE  
 United States Patent and Trademark Office  
 Address: COMMISSIONER FOR PATENTS  
 P.O. Box 1450  
 Alexandria, Virginia 22313-1450  
 www.uspto.gov

APPLICATION NO.	FILING DATE	FIRST NAMED INVENTOR	ATTORNEY DOCKET NO.	CONFIRMATION NO.
90/012,304	05/23/2012	7,469,381	0331834.381	4807

61725            7590            06/27/2012  
 Morgan Lewis & Bockius LLP/ AI  
 2 Palo Alto Square  
 3000 El Camino Real, Suite 700  
 Palo Alto, CA 94306

EXAMINER

ART UNIT            PAPER NUMBER

DATE MAILED: 06/27/2012

Please find below and/or attached an Office communication concerning this application or proceeding.



UNITED STATES PATENT AND TRADEMARK OFFICE

---

Commissioner for Patents  
United States Patents and Trademark Office  
P.O.Box 1450  
Alexandria, VA 22313-1450  
www.uspto.gov

THIRD PARTY REQUESTER'S CORRESPONDENCE ADDRESS  
BRYAN CAVE LLP  
1290 AVENUE OF THE AMERICAS  
NEW YORK, NY 10104

Date: **MAILED**

**JUN 27 2012**

**CENTRAL REEXAMINATION UNIT**

**EX PARTE REEXAMINATION COMMUNICATION TRANSMITTAL FORM**

REEXAMINATION CONTROL NO. : 90012304  
PATENT NO. : 7469381  
ART UNIT : 3992

Enclosed is a copy of the latest communication from the United States Patent and Trademark Office in the above identified ex parte reexamination proceeding (37 CFR 1.550(f)).

Where this copy is supplied after the reply by requester, 37 CFR 1.535, or the time for filing a reply has passed, no submission on behalf of the ex parte reexamination requester will be acknowledged or considered (37 CFR 1.550(g)).

---

<b>Ex Parte Reexamination Interview Summary – Pilot Program for Waiver of Patent Owner's Statement</b>	<b>Control No.</b>	<b>Patent For Which Reexamination is Requested</b>
	90/012,304 Examiner	7,469,381 Art Unit  3992

-- The MAILING DATE of this communication appears on the cover sheet with the correspondence address. --

All participants (USPTO official and patent owner):

**MAILED**

(1) Karen Ward, CRU

(3)

JUN 27 2012

(2) Gary Williams, 31066

(4)

**CENTRAL REEXAMINATION UNIT**

Date of Telephonic Interview: June 20, 2012.

The USPTO official requested waiver of the patent owner's statement pursuant to the pilot program for waiver of patent owner's statement in *ex parte* reexamination proceedings.\*

The patent owner **agreed** to waive its right to file a patent owner's statement under 35 U.S.C. 304 in the event reexamination is ordered for the above-identified patent.

The patent owner **did not agree** to waive its right to file a patent owner's statement under 35 U.S.C. 304 at this time.

The patent owner is not required to file a written statement of this telephone communication under 37 CFR 1.560(b) or otherwise. However, any disagreement as to this interview summary must be brought to the immediate attention of the USPTO, and no later than one month from the mailing date of this interview summary. Extensions of time are governed by 37 CFR 1.550(c).

\*For more information regarding this pilot program, see *Pilot Program for Waiver of Patent Owner's Statement in Ex Parte Reexamination Proceedings*, 75 Fed. Reg. 47269 (August 5, 2010), available on the USPTO Web site at <http://www.uspto.gov/patents/law/notices/2010.jsp>.

USPTO personnel were unable to reach the patent owner.

The patent owner may contact the USPTO personnel at the telephone number provided below if the patent owner decides to waive the right to file a patent owner's statement under 35 U.S.C. 304.

/Karen Ward/

571-272-7932

Signature and telephone number of the USPTO official who contacted or attempted to contact the patent owner.

cc: Requester (if third party requester)



UNITED STATES PATENT AND TRADEMARK OFFICE

UNITED STATES DEPARTMENT OF COMMERCE  
 United States Patent and Trademark Office  
 Address: COMMISSIONER FOR PATENTS  
 P.O. Box 1450  
 Alexandria, Virginia 22313-1450  
 www.uspto.gov

APPLICATION NO.	FILING DATE	FIRST NAMED INVENTOR	ATTORNEY DOCKET NO.	CONFIRMATION NO.
90/012,304	05/23/2012	7,469,381	P4304USREX2/063266-5682US	4807

61725            7590            07/30/2012  
 Morgan Lewis & Bockius LLP/ AI  
 2 Palo Alto Square  
 3000 El Camino Real, Suite 700  
 Palo Alto, CA 94306

EXAMINER
----------

ART UNIT	PAPER NUMBER
----------	--------------

DATE MAILED: 07/30/2012

Please find below and/or attached an Office communication concerning this application or proceeding.



UNITED STATES PATENT AND TRADEMARK OFFICE

Commissioner for Patents  
United States Patent and Trademark Office  
P.O. Box 1450  
Alexandria, VA 22313-1450  
[www.uspto.gov](http://www.uspto.gov)

**DO NOT USE IN PALM PRINTER**

(THIRD PARTY REQUESTER'S CORRESPONDENCE ADDRESS)

BRYAN CAVE LLP

1290 AVENUE OF THE AMERICAS

NEW YORK, NY 10104

**MAILED**

JUL 30 2012

**CENTRAL REEXAMINATION UNIT**

**EX PARTE REEXAMINATION COMMUNICATION TRANSMITTAL FORM**

REEXAMINATION CONTROL NO. 90/012,304.

PATENT NO. 7,469,381.

ART UNIT 3992.

Enclosed is a copy of the latest communication from the United States Patent and Trademark Office in the above identified *ex parte* reexamination proceeding (37 CFR 1.550(f)).

Where this copy is supplied after the reply by requester, 37 CFR 1.535, or the time for filing a reply has passed, no submission on behalf of the *ex parte* reexamination requester will be acknowledged or considered (37 CFR 1.550(g)).

<b>Order Granting / Denying Request For Ex Parte Reexamination</b>	<b>Control No.</b> 90/012,304	<b>Patent Under Reexamination</b> 7,469,381
	<b>Examiner</b> DENNIS BONSHOCK	<b>Art Unit</b> 3992

**--The MAILING DATE of this communication appears on the cover sheet with the correspondence address--**

The request for *ex parte* reexamination filed 23 May 2012 has been considered and a determination has been made. An identification of the claims, the references relied upon, and the rationale supporting the determination are attached.

Attachments: a)  PTO-892,      b)  PTO/SB/08,      c)  Other: \_\_\_\_\_

1.  The request for *ex parte* reexamination is GRANTED.

**RESPONSE TIMES ARE SET AS FOLLOWS:**

For Patent Owner's Statement (Optional): **TWO MONTHS** from the mailing date of this communication (37 CFR 1.530 (b)). **EXTENSIONS OF TIME ARE GOVERNED BY 37 CFR 1.550(c).**

For Requester's Reply (optional): **TWO MONTHS** from the **date of service** of any timely filed Patent Owner's Statement (37 CFR 1.535). **NO EXTENSION OF THIS TIME PERIOD IS PERMITTED.** If Patent Owner does not file a timely statement under 37 CFR 1.530(b), then no reply by requester is permitted.

2.  The request for *ex parte* reexamination is DENIED.

This decision is not appealable (35 U.S.C. 303(c)). Requester may seek review by petition to the Commissioner under 37 CFR 1.181 within **ONE MONTH** from the mailing date of this communication (37 CFR 1.515(c)). **EXTENSION OF TIME TO FILE SUCH A PETITION UNDER 37 CFR 1.181 ARE AVAILABLE ONLY BY PETITION TO SUSPEND OR WAIVE THE REGULATIONS UNDER 37 CFR 1.183.**

In due course, a refund under 37 CFR 1.26 (c) will be made to requester:

- a)  by Treasury check or,  
b)  by credit to Deposit Account No. \_\_\_\_\_, or  
c)  by credit to a credit card account, unless otherwise notified (35 U.S.C. 303(c)).

/Dennis G. Bonshock/  
Primary Examiner, Art Unit 3992

cc: Requester ( if third party requester )

Application/Control Number: 90/012,304  
Art Unit: 3992

Page 2

### **DECISION ON REQUEST FOR REEXAMINATION**

A substantial new question of patentability affecting claims 1-20, of United States Patent Number: 7,469,381 issued to Ording is raised by the request for *ex parte* reexamination.

Extensions of time under 37 CFR 1.136(a) will not be permitted in these proceedings because the provisions of 37 CFR 1.136 apply only to "an applicant" and not to parties in a reexamination proceeding. Additionally, 35 U.S.C. 305 requires that *ex parte* reexamination proceedings "will be conducted with special dispatch" (37 CFR 1.550(a)). Extensions of time in *ex parte* reexamination proceedings are provided for in 37 CFR 1.550(c).

### **References**

- (1) WO 03/081458 issued to Luigi Lira ("Lira")
- (2) US 7,786,975 issued to Bas Ording et al ("Ording")
- (3) WO 01/029702 issued to Elise A. W. H. Van Den Hoven et al ("Van Den Hoven")

### **Prosecution History**

U.S. Patent Application Serial No. 11/956,969, which resulted in issued Patent 7,469,381 (hereinafter the '381 patent), was filed on 12/14/2007.

On February 28, 2008, the U.S. Patent and Trademark Office (PTO) dismissed the Petition to Make Special citing the Applicant's search terms and the resulting

Application/Control Number: 90/012,304

Page 3

Art Unit: 3992

narrowness of the search as the reason for dismissal. In response to the dismissal, Applicant filed on March 13, 2008 a Request for Reconsideration along with a revised Pre-Examination search statement which included the supplemental search terms required by the PTO. According to the Applicant, the supplemental search did not reveal any additional relevant references. Applicant's Petition to Make Special was granted on April 17, 2008. In the Applicant's Supplemental Accelerated Examination Support Document filed on April 30, 2008, Applicant cited U.S. Patent 6,690,387 to Zimmerman et al. ("Zimmerman"), U.S. Patent 5,495,566 to Kwatinetz et al. ("Kwatinetz"), U.S. Patent Application Publication 2005/0012723 ("Pallakoff") and D. Miller, Personal Java Application Environment, (1999) ("Miller") as the references most closely related to the subject matter claimed in the Application.

On June 2, 2008, the PTO Examiner conducted an interview with the Applicant during which the parties discussed Zimmerman, a collection of Microsoft Word screenshots and U.S. Patent Application Publication 2008/0104544 ("Collins"). At the interview, Applicant agreed to amend the last limitation of each of the independent claims to read "in response to detecting that the object is no longer on or near the touch screen display, translating the document in a second direction until the area beyond the edge of the document is no longer displayed." The agreed to amendment was to replace the following language "after the object is no longer detected" phrasing used in the independent claims of the original application with the phrasing "in response to detecting that the object."



Application/Control Number: 90/012,304

Page 4

Art Unit: 3992

During a second interview on June 30, 2008, the Applicant and Examiner again discussed the Zimmerman reference along with Photo Mesa screenshots and U.S. Publication 2004/0027398 ("Jaeger"). To distinguish over the cited prior art, Applicant proposed to make further amendments to the claims. During a third interview on August 4, 2008, Applicant's proposed amended claims were discussed with the Examiner along with the Photo Mesa and Jaeger references. The Examiner conceded that the proposed amended claims were patentable over the cited prior art, and agreed to enter the changes by an Examiner's amendment. The Examiner's amendment mainly added four displayed portions of the electronic document at various stages of the process recited in each independent claim.

A Notice of Allowance issued on October 29, 2008, in which the Examiner's amendments and reasons for allowance were detailed. In particular, the Examiner's reasons for allowance stated that the prior art failed to teach: 1) in response to an edge of the document being reached while translating the document in a first direction, displaying an area beyond the edge of the document along with a third portion of the document that is smaller than the first portion; and 2) in response to no longer detecting the object, translating the document in a second direction until the area beyond the edge is no longer displayed, and displaying a fourth portion of the electronic document that is distinct from the first portion. The '381 Patent subsequently issued on December 23, 2008.

Application/Control Number: 90/012,304

Page 5

Art Unit: 3992

### **Reexamination History**

On April 28, 2010, a Request for Ex Parte Reexamination (90/010963) was filed at the PTO in connection with the '381 Patent. On July 14, 2010, the PTO issued a Decision Granting Ex Parte Reexamination finding that the references cited in the request raised a substantial new question of patentability with respect to all claims of the '381 Patent. The Request for Ex Parte Reexamination cited the following references as the basis for the substantial new question of patentability: Forlines et al., Glimpse: A Novel Input Model for Multi-Level Devices, (2005) ("Glimpse"), Millhollon et al., Microsoft Office Word 2003 Inside Out, (2003) ("Inside Out"), U.S. Patent Application Publication 2005/0195154 ("Robbins") and Zimmerman. The Decision stated that although Zimmerman was previously cited, it had not been considered in combination with the new prior art, namely, Glimpse, Inside and Robbins which were submitted with the reexamination request.

On January 13, 2011, the PTO issued a Notice of Intent to Issue Ex Parte Reexamination Certificate confirming the patentability of claims 1-20 of the '381 Patent. The Examiner found that, while the prior art (e.g., Inside Out) discloses displaying an area beyond the edge of the document, none of the Glimpse, Inside Out, Robbins or Zimmerman references taught or suggested the following: "in response to detecting that the object is no longer on or near the touch screen display, translating the electronic document in a second direction until the area beyond the edge of the electronic document is no longer displayed to display a fourth portion of the electronic document wherein the fourth portion is different than the first portion."

Application/Control Number: 90/012,304  
Art Unit: 3992

Page 6

### **Substantial New Question of Patentability**

The Requester suggests that the following references and/or combinations of references provide elements which are allegedly equivalent to claims 1-20 of the '381 patent.

Claim 1 is presented below with italicized sections showing the limitations that are believed to be the allowable limitations, and which are used by the Examiner to show how specific teachings of the proposed references raise a substantial new question of patentability.

Claim 1:

1. A computer-implemented method, comprising:  
at a device with a touch screen display: displaying a first portion of an electronic document;  
detecting a movement of an object on or near the touch screen display;  
in response to detecting the movement, translating the electronic document displayed on the touch screen display in a first direction to display a second portion of the electronic document, wherein the second portion is different from the first portion;  
***in response to an edge of the electronic document being reached while translating the electronic document in the first direction while the object is still detected on or near the touch screen display:***

Application/Control Number: 90/012,304

Page 7

Art Unit: 3992

***displaying an area beyond the edge of the document, and  
displaying a third portion of the electronic document, wherein the  
third portion is smaller than the first portion; and  
in response to detecting that the object is no longer on or near the  
touch screen display, translating the electronic document in  
a second direction until the area beyond the edge of the  
electronic document is no longer displayed to display a  
fourth portion of the electronic document, wherein the fourth  
portion is different from the first portion.***

#### **LIRA REFERENCE**

The Requestor alleges that Lira raises a substantial new question of patentability with respect to claims 1-20 of the '381 patent. For purposes of determination, claim 1 is a representative claim. For purposes of Reexamination the reading of Lira on the claims is provided on pages 23-60 of the Request and in Exhibit 6, Part A - Pages 1-30, Part B - Pages 1-16, Part C - Pages 1-17.

Lira is new art that provides new, non-cumulative technological teachings that were not previously considered and discussed on the record during prosecution or reexamination of the 381 patent.

Application/Control Number: 90/012,304  
Art Unit: 3992

Page 8

*Lira* teaches a system for browsing documents arranged in columns on a small screen display device via a display window (200) superimposed over a larger than fully displayable webpage. The user can pan/scroll back and forth via tactile input between columns and outside of the display space (see figures 2 and 14), where when the user lifts their finger off of the screen subsequent to a panning, the display window snaps (pans automatically via an animated motion) to align with the nearest column (see pages 14-15 and figure 14B).

Specifically:

The requestor alleges that the limitation of ***in response to an edge of the electronic document being reached while translating the electronic document in the first direction while the object is still detected on or near the touch screen display: displaying an area beyond the edge of the document, and displaying a third portion of the electronic document, wherein the third portion is smaller than the first portion*** recited in claim 1, of the '381 patent is equivalent to the *user moving the display laterally away from the column being read during panning/scrolling, where the display screen displays an additional area outside of the edge of the column* (see page 14, line 29 through page 15, line 31 and figure 14B of *Lira*). (see pages 32-34 for the Request)

Application/Control Number: 90/012,304

Page 9

Art Unit: 3992

The requestor alleges that the limitation of *in response to detecting that the object is no longer on or near the touch screen display, translating the electronic document in a second direction until the area beyond the edge of the electronic document is no longer displayed to display a fourth portion of the electronic document, wherein the fourth portion is different from the first portion* recited in claim 1, of the '381 patent is equivalent to the *snapping to the nearest column subsequent to the user terminating scrolling by moving the display screen in a second direction* (see page 14, line 29 through page 15, line 31 and figure 14B of Lira). (see pages 34-37 for the Request)

It is agreed that Lira, either alone or in combination with other prior art references (Van Den Hoven), as proposed in the request, raises a SNQ with respect to at least claim 1 of the '381 patent. There is a substantial likelihood that a reasonable Examiner would consider this teaching important in deciding whether or not these claims are patentable.

Accordingly, the Lira reference raises a substantial new question to at least claim 1, and likely claims 2-20, which question has not been decided in a previous examination of the '381 patent nor was there a final holding of invalidity by the Federal Courts regarding the '381 patent.

Application/Control Number: 90/012,304

Page 10

Art Unit: 3992

### ORDING REFERENCE

The Requestor alleges that Ording raises a substantial new question of patentability with respect to claims 1-5, 7-13, and 15-20 of the '381 patent. For purposes of determination, claim 1 is a representative claim. For purposes of Reexamination the reading of Ording on the claims is provided on pages 61-85 of the Request and in Exhibit 6, Part d - Pages 1-38.

Ording is new art that provides new, non-cumulative technological teachings that were not previously considered and discussed on the record during prosecution or reexamination of the 381 patent.

*Ording teaches* a system for scrolling a list of items where when a user approaches the end of the list, and maintains touch based input, the list is scrolled past the last element revealing an overflow area. When the user releases contact the list bounces back in the opposite direction to place a new list region back in the display (see 6:60-7:5 and 9:10-36)

Specifically:

The requestor alleges that the limitation of ***in response to an edge of the electronic document being reached while translating the electronic document in the first direction while the object is still detected on or near the touch screen***

Application/Control Number: 90/012,304

Page 11

Art Unit: 3992

**display: displaying an area beyond the edge of the document, and displaying a third portion of the electronic document, wherein the third portion is smaller than the first portion** recited in claim 1, of the '381 patent is equivalent to the user scrolling the list out of view till element 612-1, the item at the beginning of the list, is the only one remaining on the bottom of the screen, where this scrolling of the list off the screen results in a display an empty are above element 612-1 (third portion), smaller than the first portion where the screen is filled with elements (see 9:10-36 and figures 7A-C). (see 70-72 for the Request)

The requestor alleges that the limitation of **in response to detecting that the object is no longer on or near the touch screen display, translating the electronic document in a second direction until the area beyond the edge of the electronic document is no longer displayed to display a fourth portion of the electronic document, wherein the fourth portion is different from the first portion** recited in claim 1, of the '381 patent is equivalent to the *bouncing back of the list back onto the screen after the use attempted to scroll the list off of the screen* (see 9:10-36 and figures 7A-C). (see 72-75 for the Request)

It is agreed that Ording, as proposed in the request, raises a SNQ with respect to at least claim 1 of the '381 patent. There is a substantial likelihood that a reasonable Examiner would consider this teaching important in deciding whether or not these claims are patentable.



Application/Control Number: 90/012,304  
Art Unit: 3992

Page 12

Accordingly, the Lira reference raises a substantial new question to at least claim 1, and likely claims 2-5, 7-13, and 15-20, which question has not been decided in a previous examination of the '381 patent nor was there a final holding of invalidity by the Federal Courts regarding the '381 patent.

### **VAN DEN HODEN REFERENCE**

The Van Den Hoden reference individually does not raise an SNQ, however, in light of the SNQ's raised in view of the Lira reference, Van Den Hoden raise a SNQ with respect to claims 7, 13-15, 17, and 18 of the '381 patent.

### **Summary**

Claims 1-20 will be reexamined as requested in the Request.

### ***Conclusion***

**Extensions of time under 37 CFR 1.136(a) do not apply in reexamination proceedings.** The provisions of 37 CFR 1.136 apply only to "an applicant" and not to parties in a reexamination proceeding. Further, in 35 U.S.C. 305 and in 37 CFR 1.550(a), it is required that reexamination proceedings "will be conducted with special dispatch within the Office."

The patent owner is reminded of the continuing responsibility under 37 CFR 1.565(a) to apprise the Office of any litigation activity, or other prior or concurrent proceeding, involving the patent throughout the course of this reexamination proceeding. The requester is also reminded of

Application/Control Number: 90/012,304

Page 13

Art Unit: 3992

the ability to similarly appraise the Office of any such activity or proceeding throughout the course of this reexamination proceeding. See MPEP § § 2207, 2282, and 2286.

All correspondence relating to this *ex parte* reexamination proceeding should be directed:

By Mail to: Mail Stop Ex Parte Reexam  
Central Reexamination Unit  
Commissioner for Patents  
United States Patent & Trademark Office  
P.O. Box 1450  
Alexandria, VA 22313-1450

By FAX to: (571) 273-9900  
Central Reexamination Unit

By hand: Customer Service Window  
Randolph Building  
401 Dulany Street  
Alexandria, VA 22314

By EFS-Web:

Application/Control Number: 90/012,304

Page 14

Art Unit: 3992

Registered users of EFS-Web may alternatively submit such correspondence via the electronic filing system EFS-Web, at

<https://efs.uspto.gov/efile/myportal/efs-registered>

EFS-Web offers the benefit of quick submission to the particular area of the Office that needs to act on the correspondence. Also, EFS-Web submissions are "soft scanned" (i.e., electronically uploaded) directly into the official file for the reexamination proceeding, which offers parties the opportunity to review the content of their submissions after the "soft scanning" process is complete.

Any inquiry concerning this communication or earlier communications from the Reexamination Legal Advisor or Examiner, or as to the status of this proceeding, should be directed to the Central Reexamination Unit at telephone number (571) 272-7705.

/Dennis G. Bonshock/

Central Reexamination Unit 3992

/Adam L Basehoar/

Primary Examiner, Art Unit 3992

ALEXANDER J. KOSOWSKI  
Supervisory Patent Reexamination Specialist  
CRU -- Art Unit 3992

ASK

Doc code: IDS

Doc description: Information Disclosure Statement (IDS) Filed

PTO/SB/08a (01-10)

Approved for use through 07/31/2012. OMB 0651-0031

U.S. Patent and Trademark Office; U.S. DEPARTMENT OF COMMERCE

Under the Paperwork Reduction Act of 1995, no persons are required to respond to a collection of information unless it contains a valid OMB control number.

<b>INFORMATION DISCLOSURE STATEMENT BY APPLICANT</b> (Not for submission under 37 CFR 1.99)	Application Number		
	Filing Date		
	First Named Inventor		
	Art Unit		
	Examiner Name		
	Attorney Docket Number		0331834.381

**U.S.PATENTS**

Examiner Initial*	Cite No	Patent Number	Kind Code <sup>1</sup>	Issue Date	Name of Patentee or Applicant of cited Document	Pages, Columns, Lines where Relevant Passages or Relevant Figures Appear
	1	7786975		2010-08-31	Ording et al.	

If you wish to add additional U.S. Patent citation information please click the Add button.

**U.S.PATENT APPLICATION PUBLICATIONS**

Examiner Initial*	Cite No	Publication Number	Kind Code <sup>1</sup>	Publication Date	Name of Patentee or Applicant of cited Document	Pages, Columns, Lines where Relevant Passages or Relevant Figures Appear
	1					

If you wish to add additional U.S. Published Application citation information please click the Add button.

**FOREIGN PATENT DOCUMENTS**

Examiner Initial*	Cite No	Foreign Document Number <sup>3</sup>	Country Code <sup>2</sup>	Kind Code <sup>4</sup>	Publication Date	Name of Patentee or Applicant of cited Document	Pages, Columns, Lines where Relevant Passages or Relevant Figures Appear	T <sup>5</sup>
	1	WO 01/29702	WO		2001-04-26	Van Den Hoven et al.		<input type="checkbox"/>
	2	WO 03/081458	WO		2003-10-02	Lira		<input type="checkbox"/>

If you wish to add additional Foreign Patent Document citation information please click the Add button

**NON-PATENT LITERATURE DOCUMENTS**

<b>INFORMATION DISCLOSURE STATEMENT BY APPLICANT</b> (Not for submission under 37 CFR 1.99)	Application Number	
	Filing Date	
	First Named Inventor	
	Art Unit	
	Examiner Name	
	Attorney Docket Number	0331834.381

Examiner Initials*	Cite No	Include name of the author (in CAPITAL LETTERS), title of the article (when appropriate), title of the item (book, magazine, journal, serial, symposium, catalog, etc), date, pages(s), volume-issue number(s), publisher, city and/or country where published.	T <sup>5</sup>
	1		<input type="checkbox"/>

If you wish to add additional non-patent literature document citation information please click the Add button

**EXAMINER SIGNATURE**

Examiner Signature	/Dennis Bonshock/	Date Considered	07/27/2012
--------------------	-------------------	-----------------	------------

\*EXAMINER: Initial if reference considered, whether or not citation is in conformance with MPEP 609. Draw line through a citation if not in conformance and not considered. Include copy of this form with next communication to applicant.

<sup>1</sup>See Kind Codes of USPTO Patent Documents at [www.USPTO.GOV](http://www.USPTO.GOV) or MPEP 901.04. <sup>2</sup>Enter office that issued the document, by the two-letter code (WIPO Standard ST.3). <sup>3</sup>For Japanese patent documents, the indication of the year of the reign of the Emperor must precede the serial number of the patent document. <sup>4</sup>Kind of document by the appropriate symbols as indicated on the document under WIPO Standard ST.16 if possible. <sup>5</sup>Applicant is to place a check mark here if English language translation is attached.

<b>INFORMATION DISCLOSURE STATEMENT BY APPLICANT</b> (Not for submission under 37 CFR 1.99)	Application Number	
	Filing Date	
	First Named Inventor	
	Art Unit	
	Examiner Name	
	Attorney Docket Number	0331834.381

### CERTIFICATION STATEMENT

Please see 37 CFR 1.97 and 1.98 to make the appropriate selection(s):

- That each item of information contained in the information disclosure statement was first cited in any communication from a foreign patent office in a counterpart foreign application not more than three months prior to the filing of the information disclosure statement. See 37 CFR 1.97(e)(1).

**OR**

- That no item of information contained in the information disclosure statement was cited in a communication from a foreign patent office in a counterpart foreign application, and, to the knowledge of the person signing the certification after making reasonable inquiry, no item of information contained in the information disclosure statement was known to any individual designated in 37 CFR 1.56(c) more than three months prior to the filing of the information disclosure statement. See 37 CFR 1.97(e)(2).

- See attached certification statement.
- The fee set forth in 37 CFR 1.17 (p) has been submitted herewith.
- A certification statement is not submitted herewith.

#### SIGNATURE

A signature of the applicant or representative is required in accordance with CFR 1.33, 10.18. Please see CFR 1.4(d) for the form of the signature.

Signature		Date (YYYY-MM-DD)	
Name/Print		Registration Number	

This collection of information is required by 37 CFR 1.97 and 1.98. The information is required to obtain or retain a benefit by the public which is to file (and by the USPTO to process) an application. Confidentiality is governed by 35 U.S.C. 122 and 37 CFR 1.14. This collection is estimated to take 1 hour to complete, including gathering, preparing and submitting the completed application form to the USPTO. Time will vary depending upon the individual case. Any comments on the amount of time you require to complete this form and/or suggestions for reducing this burden, should be sent to the Chief Information Officer, U.S. Patent and Trademark Office, U.S. Department of Commerce, P.O. Box 1450, Alexandria, VA 22313-1450. **DO NOT SEND FEES OR COMPLETED FORMS TO THIS ADDRESS. SEND TO: Commissioner for Patents, P.O. Box 1450, Alexandria, VA 22313-1450.**

## Privacy Act Statement

The Privacy Act of 1974 (P.L. 93-579) requires that you be given certain information in connection with your submission of the attached form related to a patent application or patent. Accordingly, pursuant to the requirements of the Act, please be advised that: (1) the general authority for the collection of this information is 35 U.S.C. 2(b)(2); (2) furnishing of the information solicited is voluntary; and (3) the principal purpose for which the information is used by the U.S. Patent and Trademark Office is to process and/or examine your submission related to a patent application or patent. If you do not furnish the requested information, the U.S. Patent and Trademark Office may not be able to process and/or examine your submission, which may result in termination of proceedings or abandonment of the application or expiration of the patent.

The information provided by you in this form will be subject to the following routine uses:

1. The information on this form will be treated confidentially to the extent allowed under the Freedom of Information Act (5 U.S.C. 552) and the Privacy Act (5 U.S.C. 552a). Records from this system of records may be disclosed to the Department of Justice to determine whether the Freedom of Information Act requires disclosure of these records.
2. A record from this system of records may be disclosed, as a routine use, in the course of presenting evidence to a court, magistrate, or administrative tribunal, including disclosures to opposing counsel in the course of settlement negotiations.
3. A record in this system of records may be disclosed, as a routine use, to a Member of Congress submitting a request involving an individual, to whom the record pertains, when the individual has requested assistance from the Member with respect to the subject matter of the record.
4. A record in this system of records may be disclosed, as a routine use, to a contractor of the Agency having need for the information in order to perform a contract. Recipients of information shall be required to comply with the requirements of the Privacy Act of 1974, as amended, pursuant to 5 U.S.C. 552a(m).
5. A record related to an International Application filed under the Patent Cooperation Treaty in this system of records may be disclosed, as a routine use, to the International Bureau of the World Intellectual Property Organization, pursuant to the Patent Cooperation Treaty.
6. A record in this system of records may be disclosed, as a routine use, to another federal agency for purposes of National Security review (35 U.S.C. 181) and for review pursuant to the Atomic Energy Act (42 U.S.C. 218(c)).
7. A record from this system of records may be disclosed, as a routine use, to the Administrator, General Services, or his/her designee, during an inspection of records conducted by GSA as part of that agency's responsibility to recommend improvements in records management practices and programs, under authority of 44 U.S.C. 2904 and 2906. Such disclosure shall be made in accordance with the GSA regulations governing inspection of records for this purpose, and any other relevant (i.e., GSA or Commerce) directive. Such disclosure shall not be used to make determinations about individuals.
8. A record from this system of records may be disclosed, as a routine use, to the public after either publication of the application pursuant to 35 U.S.C. 122(b) or issuance of a patent pursuant to 35 U.S.C. 151. Further, a record may be disclosed, subject to the limitations of 37 CFR 1.14, as a routine use, to the public if the record was filed in an application which became abandoned or in which the proceedings were terminated and which application is referenced by either a published application, an application open to public inspections or an issued patent.
9. A record from this system of records may be disclosed, as a routine use, to a Federal, State, or local law enforcement agency, if the USPTO becomes aware of a violation or potential violation of law or regulation.

**ALL REFERENCES CONSIDERED EXCEPT WHERE LINED THROUGH. /D.B./**

<b>Reexamination</b> 	Application/Control No. 90012304	Applicant(s)/Patent Under Reexamination 7,469,381
	Certificate Date	Certificate Number

**Requester Correspondence Address:**       Patent Owner       Third Party

BRYAN CAVE LLP  
1290 AVENUE OF THE AMERICAS  
NEW YORK, NY 10104

LITIGATION REVIEW <input checked="" type="checkbox"/>	DGB (examiner initials)	07/23/2012 (date)
Case Name		Director Initials
APPLE INC. v. SAMSUNG ELECTRONICS CO., LTD (N.D. CAL) Case N		ADR B. SY

COPENDING OFFICE PROCEEDINGS	
TYPE OF PROCEEDING	NUMBER

--	--



<b>Search Notes</b>  	<b>Application/Control No.</b> 90012304	<b>Applicant(s)/Patent Under Reexamination</b> 7,469,381
	<b>Examiner</b> DENNIS BONSHOCK	<b>Art Unit</b> 3992

<b>SEARCHED</b>			
<b>Class</b>	<b>Subclass</b>	<b>Date</b>	<b>Examiner</b>

<b>SEARCH NOTES</b>		
<b>Search Notes</b>	<b>Date</b>	<b>Examiner</b>
Reviewed Previous Prosecution History	7-23-12	DGB

<b>INTERFERENCE SEARCH</b>			
<b>Class</b>	<b>Subclass</b>	<b>Date</b>	<b>Examiner</b>

--	--

Electronically filed October 9, 2012

IN THE UNITED STATES PATENT AND TRADEMARK OFFICE

Patentee: Bas Ording  
Reexam. Control Nos.: 90/012,304  
Reexam. Filed: May 23, 2012  
Patent No.: 7,469,381 B2  
Attorney Docket No.: P4304USREX2/120730-002US

Group Art Unit: 3992  
Examiner: Bonshock, Dennis G  
Confirmation No.: 4807  
Issued: December 23, 2008

For: LIST SCROLLING AND DOCUMENT TRANSLATION, SCALING, AND  
ROTATION ON A TOUCH-SCREEN DISPLAY

**REVOCATION OF EXISTING POWER OF ATTORNEY,  
APPOINTMENT OF NEW POWER OF ATTORNEY,  
AND STATEMENT UNDER 37 C.F.R. §3.73(b)**

Mail Stop *Ex Parte* Reexam  
Central Reexamination Unit  
Commissioner for Patents  
United States Patent and Trademark Office  
P.O. Box 1450  
Alexandria, VA 22313-1450

Sir:

Apple Inc., with a business address of 1 Infinite Loop, Cupertino, California 95014, states that it is the assignee of the entire right, title, and interest in the above-captioned patent by virtue of a chain of title from the inventor of the above-captioned patent application to the current assignee as follows:

An assignment from Bas Ording to Apple Inc. The document was recorded in the U.S. Patent and Trademark Office at Reel 021397, Frame 0743 on August 15, 2008.

As assignee of record of the above-identified application, Apple Inc. hereby revokes all Powers of Attorney previously given and hereby appoints the attorneys and agents associated with Customer Number 108491 to prosecute the above reexamination proceeding with control no. 90/012,304, and transact all business in the Patent and

Trademark office connected therewith, and directs that all correspondence for the above-identified reexamination be sent to the address associated with the above-identified Customer Number.

It is noted that, “[t]he correspondence address for any pending reexamination proceeding not having the same correspondence address as that of the patent is, [pursuant to 37 CFR] § 1.33(c), automatically changed to that of the patent file”. *Revisions And Tech. Corrections Affecting Requirements For Ex Parte And Inter Partes Reexam.*, 72 Fed. Reg. 18892 (Apr. 16, 2007) (final rule); see, e.g., *inter partes* reexam. control nos. 95/001,697 & -714, OPLA Decision of Apr. 2, 2011, p. 2.

In accordance with this rule, action has also been taken in the patent file to change the correspondence address of the above-identified patent to the address associated with the above-identified Customer Number.

The undersigned is authorized to act on behalf of the assignee.

Apple Inc.

By: 

Name: BJ Watrous

Title: Vice President & Chief IP Counsel

Date: 10/4/12

Telephone No.: 408-974-5653

Electronically filed October 9, 2012

IN THE UNITED STATES PATENT AND TRADEMARK OFFICE

In re: Reexam of U.S. Patent No. 7,469,381 B2  
Control No. 90/012,304  
Filed: May 23, 2012  
For: **LIST SCROLLING AND DOCUMENT  
TRANSLATION, SCALING, AND  
ROTATION ON A TOUCH-SCREEN  
DISPLAY**

Confirmation No.: 4807  
Art Unit: 3992  
Examiner: Bonshock, Dennis G  
Atty. Docket:  
: P4304USREX2/120730-002US

**Certificate of Service**

Mail Stop *Ex Parte* Reexam  
Central Reexamination Unit  
Commissioner for Patents  
United States Patent and Trademark Office  
P.O. Box 1450  
Alexandria, VA 22313-1450

October 9, 2012

Sir:

In compliance with 37 C.F.R. § 1.550(f), the undersigned, on behalf of the Patent Owner, hereby certifies that a copy of the following document is being served on the Third Party Requester by first class mail on October 9, 2012.

**REVOCAION OF EXISTING POWER OF ATTORNEY,  
APPOINTMENT OF NEW POWER OF ATTORNEY, AND STATEMENT  
UNDER 37 C.F.R. §3.73(b).**

The name and address of the party being served is as follows:

Joseph J. Richetti  
BRYAN CAVE LLP  
1290 Avenue of the Americas  
New York, New York 10104

Very truly yours,

/Kenneth J. Weatherwax/  
Kenneth J. Weatherwax, Reg. No. 54,528  
Goldberg, Lowenstein & Weatherwax LLP

**Electronic Acknowledgement Receipt**

<b>EFS ID:</b>	13944844
<b>Application Number:</b>	90012304
<b>International Application Number:</b>	
<b>Confirmation Number:</b>	4807
<b>Title of Invention:</b>	LIST SCROLLING AND DOCUMENT TRANSLATION, SCALING, AND ROTATION ON A TOUCH-SCREEN DISPLAY
<b>First Named Inventor/Applicant Name:</b>	7,469,381
<b>Customer Number:</b>	61725
<b>Filer:</b>	Kenneth James Weatherwax
<b>Filer Authorized By:</b>	
<b>Attorney Docket Number:</b>	P4304USREX2/063266-5682US
<b>Receipt Date:</b>	09-OCT-2012
<b>Filing Date:</b>	23-MAY-2012
<b>Time Stamp:</b>	18:13:16
<b>Application Type:</b>	Reexam (Third Party)

**Payment information:**

Submitted with Payment	no
------------------------	----

**File Listing:**

Document Number	Document Description	File Name	File Size(Bytes)/ Message Digest	Multi Part /.zip	Pages (if appl.)
1	Reexam Miscellaneous Incoming Letter	P4304USREX2_Revocation_and _Appt_of_New_POA_1.pdf	183282 5bd2bb0cccfd2190afadc0e082e1f9c090f4 1e4	no	2

**Warnings:****Information:**

2	Reexam Certificate of Service	P4304USREX2_Certificate_of_S ervice_1.pdf	73191 c928efdb4e42ee947bda883f5b21dc04022 3c471	no	1
<b>Warnings:</b>					
<b>Information:</b>					
<b>Total Files Size (in bytes):</b>				256473	
<p><b>This Acknowledgement Receipt evidences receipt on the noted date by the USPTO of the indicated documents, characterized by the applicant, and including page counts, where applicable. It serves as evidence of receipt similar to a Post Card, as described in MPEP 503.</b></p> <p><b><u>New Applications Under 35 U.S.C. 111</u></b>  <b>If a new application is being filed and the application includes the necessary components for a filing date (see 37 CFR 1.53(b)-(d) and MPEP 506), a Filing Receipt (37 CFR 1.54) will be issued in due course and the date shown on this Acknowledgement Receipt will establish the filing date of the application.</b></p> <p><b><u>National Stage of an International Application under 35 U.S.C. 371</u></b>  <b>If a timely submission to enter the national stage of an international application is compliant with the conditions of 35 U.S.C. 371 and other applicable requirements a Form PCT/DO/EO/903 indicating acceptance of the application as a national stage submission under 35 U.S.C. 371 will be issued in addition to the Filing Receipt, in due course.</b></p> <p><b><u>New International Application Filed with the USPTO as a Receiving Office</u></b>  <b>If a new international application is being filed and the international application includes the necessary components for an international filing date (see PCT Article 11 and MPEP 1810), a Notification of the International Application Number and of the International Filing Date (Form PCT/RO/105) will be issued in due course, subject to prescriptions concerning national security, and the date shown on this Acknowledgement Receipt will establish the international filing date of the application.</b></p>					

<b>INFORMATION DISCLOSURE CITATION</b>  Substitute for Form 1449-PTO				<i>Electronically filed October 9, 2012</i>			
				Application Number		90/012,304	
				Filing Date		May 23, 2012	
				First Named Inventor		Bas Ording	
				Art Unit		3992	
Examiner Name		BONSHOCK, DENNIS G					
Sheet	1	of	8	Attorney Docket Number	P4304USREX2/12073 0-002US		

U.S. PATENT DOCUMENTS					
Examiner Initials	Cite No. <sup>1</sup>	Document Number	Publication Date MM-DD- YYYY	Name of Patentee or Applicant of Cited Document	Pages, Columns, Lines, Where Relevant Passages or Relevant Figures Appear
		Number - Kind Code <sup>2</sup>			
	US1	4,550,221	10-29-1985	Mabusth	
	US2	4,746,770	05-24-1988	McAvinney	
	US3	4,843,568	06-27-1989	Krueger et al.	
	US4	4,954,967	09-04-1990	Hiroshi	
	US5	5,374,787	12-20-1994	Miller et al.	
	US6	5,428,367	06-27-1995	Mikan	
	US7	5,483,261	01-09-1996	Yasutake	
	US8	5,488,204	01-30-1996	Mead et al.	
	US9	5,534,893	07-09-1996	Hansen et al.	
	US10	5,543,591	08-06-1996	Gillespie et al.	
	US11	5,825,352	10-20-1998	Bisset et al.	
	US12	5,835,079	11-10-1998	Shieh	
	US13	5,869,791	02-09-1999	Young	
	US14	5,880,411	03-09-1999	Gillespie et al.	
	US15	5,903,902	05-11-1999	Orr et al.	
	US16	5,942,733	08-24-1999	Allen et al.	
	US17	5,956,020	09-21-1999	D'Amico	
	US18	6,028,271	02-22-2000	Gillespie et al.	
	US19	6,028,602	02-22-2000	Weidenfeller et al.	
	US20	6,061,063	05-09-2000	Wagner et al.	
	US21	6,067,068	05-23-2000	Hussain	
	US22	6,141,018	10-31-2000	Beri et al.	
	US23	6,18,391	02-13-2001	Seely et al.	
	US24	6,239,389	05-29-2001	Allen et al.	
	US25	6,278,443	08-21-2001	Amro et al.	
	US26	6,320,610	10-30-2001	Beaton et al.	
	US27	6,323,846 B1	11-27-2001	Westerman et al.	
	US28	6,337,698	01-08-2002	Keely et al.	
	US29	6,486,896	11-26-2002	Ubillos	
	US30	6,509,907	01-21-2003	Kuwabara	
	US31	6,570,557 B1	05-27-2003	Westerman et al.	
	US32	6,677,932 B1	01-13-2004	Westerman	

Examiner Signature	Date Considered
-----------------------	--------------------

\*EXAMINER: Initial if reference considered, whether or not citation is in conformance with MPEP 609. Draw line through citation if not in conformance and not considered. Include copy of this form with next communication to applicant. <sup>1</sup> Applicant's unique citation designation number (optional). <sup>2</sup> See Kind Codes of USPTO Patent Documents at [www.uspto.gov](http://www.uspto.gov) or MPEP 901.04. <sup>3</sup> Enter Office that issued the document, by the two-letter code (WIPO Standard ST.3). <sup>4</sup> For Japanese patent documents, the indication of the year of the reign of the Emperor must precede the serial number of the patent document. <sup>5</sup> Kind of document by the appropriate symbols as indicated on the document under WIPO Standard ST. 16 if possible. <sup>6</sup> Applicant is to place a check mark here if English language translation is attached.

Burden Hour Statement: This form is estimated to take 2.0 hours to complete. Time will vary depending upon the needs of the individual case. Any comments on the amount of time you are required to complete this form should be sent to the Chief Information Officer, U.S. Patent and Trademark Office, Washington, DC 20231. DO NOT SEND FEES OR COMPLETED FORMS TO THIS ADDRESS. SEND TO: Assistant Commissioner for Patents, P.O. Box 1450, Alexandria, VA 22313-1450.

<b>INFORMATION DISCLOSURE CITATION</b>  Substitute for Form 1449-PTO				<i>Electronically filed October 9, 2012</i>			
				Application Number		90/012,304	
				Filing Date		May 23, 2012	
				First Named Inventor		Bas Ording	
				Art Unit		3992	
				Examiner Name		BONSHOCK, DENNIS G	
Sheet	2	of	8	Attorney Docket Number		P4304USREX2/12073 0-002US	

US33	6,677,965	01-13-2004	Ulmann et al.	
US34	6,741,966	05-25-2004	Brechner et al.	
US35	6,791,530	09-14-2004	Vernier et al.	
US36	6,820,237 B1	11-16-2004	Abu-Hakima et al.	
US37	6,839,721	01-04-2005	Schwols	
US38	6,903,927	06-07-2005	Anlauff	
US39	6,957,392	10-18-2005	Simister et al.	
US40	6,958,749	10-25-2005	Matsushita et al.	
US41	6,970,160	11-29-2005	Mulligan et al.	
US42	7,009,626	03-07-2006	David et al.	
US43	7,015,894	03-21-2006	Morohoshi	
US44	7,030,860	04-18-2006	Hsu et al.	
US45	7,081,866	07-25-2006	Nakano et al.	
US46	7,109,978	9-19-2006	Gillespie et al.	
US47	7,117,453	10-03-2006	Drucker et al.	
US48	7,152,210	12-19-2006	Van Den Hoven et al.	
US49	7,173,623	02-06-2007	Calkins et al.	
US50	7,184,064	02-27-2007	Zimmerman et al.	
US51	7,254,775	08-07-2007	Geaghan et al.	
US52	7,337,412	02-26-2008	Guido et al.	
US53	7,346,850	03-18-2008	Swartz et al.	
US54	7,355,620	04-08-2008	Ikehata et al.	
US55	7,382,139	06-03-2008	Mackey	
US56	7,411,575	08-12-2008	Hill et al.	
US57	7,446,783	11-04-2008	Grossman	
US58	7,450,113	11-11-2008	Gillespie et al.	
US59	7,450,114	11-11-2008	Anwar	
US60	7,479,949	01-20-2009	Jobs et al.	
US61	7,511,702	03-31-2009	Hotelling	
US62	7,532,205	05-12-2009	Gillespie et al.	
US63	7,561,159	07-14-2009	Abel et al.	
US64	7,576,732	08-01-2009	Lii	
US65	7,612,786	11-03-2009	Vale et al.	
US66	7,658,675	02-09-2010	Hotta	
US67	7,663,607	02-16-2010	Hotelling et al.	
US68	7,735,016	06-08-2010	Celik et al.	

Examiner Signature	Date Considered
-----------------------	--------------------

\*EXAMINER: Initial if reference considered, whether or not citation is in conformance with MPEP 609. Draw line through citation if not in conformance and not considered. Include copy of this form with next communication to applicant. <sup>1</sup> Applicant's unique citation designation number (optional). <sup>2</sup> See Kind Codes of USPTO Patent Documents at [www.uspto.gov](http://www.uspto.gov) or MPEP 901.04. <sup>3</sup> Enter Office that issued the document, by the two-letter code (WIPO Standard ST.3). <sup>4</sup> For Japanese patent documents, the indication of the year of the reign of the Emperor must precede the serial number of the patent document. <sup>5</sup> Kind of document by the appropriate symbols as indicated on the document under WIPO Standard ST. 16 if possible. <sup>6</sup> Applicant is to place a check mark here if English language translation is attached.

Burden Hour Statement: This form is estimated to take 2.0 hours to complete. Time will vary depending upon the needs of the individual case. Any comments on the amount of time you are required to complete this form should be sent to the Chief Information Officer, U.S. Patent and Trademark Office, Washington, DC 20231. DO NOT SEND FEES OR COMPLETED FORMS TO THIS ADDRESS. SEND TO: Assistant Commissioner for Patents, P.O. Box 1450, Alexandria, VA 22313-1450.



<b>INFORMATION DISCLOSURE CITATION</b>  Substitute for Form 1449-PTO				<i>Electronically filed October 9, 2012</i>			
				Application Number		90/012,304	
				Filing Date		May 23, 2012	
				First Named Inventor		Bas Ording	
				Art Unit		3992	
				Examiner Name		BONSHOCK, DENNIS G	
Sheet	3	of	8	Attorney Docket Number	P4304USREX2/12073 0-002US		

	US69	7,786,975	08-31-2010	Ording	
	US70	7,844,913	11-30-2010	Amano et al.	
	US71	7,872,640	01-18-2011	Lira	
<b>U.S. PATENT APPLICATION PUBLICATIONS</b>					
	USA1	2001/0028369 A1	10-11-2001	Gallo et al.	
	USA2	2001/045949	11-29-2001	Chithamharam et al.	
	USA3	2002/0015024 A1	02-07-2002	Westerman et al.	
	USA4	2002/0036618	03-28-2002	Wakai	
	USA5	2002/0067346	06-06-2002	Mouton	
	USA6	2002/0194589	12-01-2002	Cristofalo et al.	
	USA7	2003/0095096	05-22-2003	Robbin et al.	
	USA8	2003/0122787	07-03-2003	Zimmerman et al.	
	USA9	2003/0160832	08-01-2003	Ridgley et al.	
	USA10	2003/0231168	12-18-2003	Bell et al.	
	USA11	2003/132959	07-17-2003	Simister et al.	
	USA12	2003/174149	09-18-2003	Fujisaki	
	USA13	2004/0021698	02-01-2004	Baldwin et al.	
	USA14	2004/0034801	02-19-2004	Jaeger	
	USA15	2004/0100479	05-27-2004	Nakano et al.	
	USA16	2004/0167919	08-26-2004	Sterling et al.	
	USA17	2004/0215643	10-01-2004	Brecher et al.	
	USA18	2004/0224638	11-11-2004	Fadell et al.	
	USA19	2004/222992	11-11-2004	Calkins et al.	
	USA20	2005/0041385	02-24-2005	Kikinis et al.	
	USA21	2005/0057524	03-17-2005	Hill et al.	
	USA22	2005/0088418	04-28-2005	Westerman et al.	
	USA23	2005/0122806 A1	06-09-2005	Arakawa et al.	
	USA24	2005/0168353	08-04-2005	Dement et al.	
	USA25	2005/0193015	09-01-2005	Logston et al.	
	USA26	2005/0275636 A1	12-15-2005	Dehlin et al.	
	USA27	2005/088443	04-28-2005	Blanco et al.	
	USA28	2006/0010400 A1	01-12-2006	Dehlin et al.	
	USA29	2006/0038796	02-23-2006	Hinckley	
	USA30	2006/0084852	04-20-2006	Mason et al.	
	USA31	2006/0097991	05-11-2006	Hotelling et al.	

Examiner Signature		Date Considered	
--------------------	--	-----------------	--

\*EXAMINER: Initial if reference considered, whether or not citation is in conformance with MPEP 609. Draw line through citation if not in conformance and not considered. Include copy of this form with next communication to applicant. <sup>1</sup> Applicant's unique citation designation number (optional). <sup>2</sup> See Kind Codes of USPTO Patent Documents at [www.uspto.gov](http://www.uspto.gov) or MPEP 901.04. <sup>3</sup> Enter Office that issued the document, by the two-letter code (WIPO Standard ST.3). <sup>4</sup> For Japanese patent documents, the indication of the year of the reign of the Emperor must precede the serial number of the patent document. <sup>5</sup> Kind of document by the appropriate symbols as indicated on the document under WIPO Standard ST. 16 if possible. <sup>6</sup> Applicant is to place a check mark here if English language Translation is attached.

Burden Hour Statement: This form is estimated to take 2.0 hours to complete. Time will vary depending upon the needs of the individual case. Any comments on the amount of time you are required to complete this form should be sent to the Chief Information Officer, U.S. Patent and Trademark Office, Washington, DC 20231. DO NOT SEND FEES OR COMPLETED FORMS TO THIS ADDRESS. SEND TO: Assistant Commissioner for Patents, P.O. Box 1450, Alexandria, VA 22313-1450.

<b>INFORMATION DISCLOSURE CITATION</b>  Substitute for Form 1449-PTO				<i>Electronically filed October 9, 2012</i>			
				Application Number		90/012,304	
				Filing Date		May 23, 2012	
				First Named Inventor		Bas Ording	
				Art Unit		3992	
Examiner Name		BONSHOCK, DENNIS G					
Sheet	4	of	8	Attorney Docket Number	P4304USREX2/12073 0-002US		

	USA32	2006/0101354	05-11-2006	Hashimoto et al.	
	USA33	2006/0190833 A1	08-24-2006	SanGiovanni et al.	
	USA34	2006/0236263	10-19-2006	Bathiche at al.	
	USA35	2007/0028191	02-01-2007	Tsuji	
	USA36	2007/0035513	02-15-2007	Sherrard et al.	
	USA37	2007/0055967	03-08-2007	Poff et al.	
	USA38	2007/0064004	03-22-2007	Bonner et al.	
	USA39	2007/0075965	04-05-2007	Huppi et al.	
	USA40	2007/0081726	04-12-2007	Westerman et al.	
	USA41	2007/0132789	06-14-2007	Ording et al.	
	USA42	2007/0146337	06-28-2007	Ording et al.	
	USA43	2007/0149252 A1	06-28-2007	Jobs et al.	
	USA44	2007/0152984	07-05-2007	Ording et al.	
	USA45	2007/0157089 A1	07-05-2007	Van Os et al.	
	USA46	2007/0157094	07-05-2007	Van Os et al.	
	USA47	2007/0182743 A1	08-09-2007	Aguera y Arcas	
	USA48	2007/0185876	08-01-2007	Howard	
	USA49	2007/0252821	11-01-2007	Holleman et al.	
	USA50	2007/0256026	11-01-2007	Klassen et al.	
	USA51	2007/0262964 A1	11-15-2007	Zotov et al.	
	USA52	2007/028856	12-01-2007	Butlin et al.	
	USA53	2008/0005703	01-01-2008	Radivojevic et al.	
	USA54	2008/0016096	01-17-2008	Wilding et al.	
	USA55	2008/0034029	02-01-2008	Guido et al.	
	USA56	2008/0048978	07-01-2008	Ording et al.	
	USA57	2008/0052945	03-06-2008	Matas et al.	
	USA58	2008/0062207	03-13-2008	Park	
	USA59	2008/0094369	04-24-2008	Ganatra et al.	
	USA60	2008/0168395	01-01-2004	Ulmann et al.	
	USA61	2008/0168404	07-10-2008	Ording	
	USA62	2008/0231610	09-01-2008	Hotelling et al.	
	USA63	2009/0244020 A1	10-01-2009	Sjolin	
	USA64	2009/0249252 A1	10-01-2009	Lunday et al.	
	USA65	2009/0307623	12-10-2009	Agarawala et al.	
	USA66	2010/0172624	07-08-2010	Watts	

Examiner Signature		Date Considered	
-----------------------	--	--------------------	--

\*EXAMINER: Initial if reference considered, whether or not citation is in conformance with MPEP 609. Draw line through citation if not in conformance and not considered. Include copy of this form with next communication to applicant. <sup>1</sup> Applicant's unique citation designation number (optional). <sup>2</sup> See Kind Codes of USPTO Patent Documents at [www.uspto.gov](http://www.uspto.gov) or MPEP 901.04. <sup>3</sup> Enter Office that issued the document, by the two-letter code (WIPO Standard ST.3). <sup>4</sup> For Japanese patent documents, the indication of the year of the reign of the Emperor must precede the serial number of the patent document. <sup>5</sup> Kind of document by the appropriate symbols as indicated on the document under WIPO Standard ST. 16 if possible. <sup>6</sup> Applicant is to place a check mark here if English language Translation is attached.

Burden Hour Statement: This form is estimated to take 2.0 hours to complete. Time will vary depending upon the needs of the individual case. Any comments on the amount of time you are required to complete this form should be sent to the Chief Information Officer, U.S. Patent and Trademark Office, Washington, DC 20231. DO NOT SEND FEES OR COMPLETED FORMS TO THIS ADDRESS. SEND TO: Assistant Commissioner for Patents, P.O. Box 1450, Alexandria, VA 22313-1450.

<b>INFORMATION DISCLOSURE CITATION</b>  Substitute for Form 1449-PTO				<i>Electronically filed October 9, 2012</i>			
				Application Number		90/012,304	
				Filing Date		May 23, 2012	
				First Named Inventor		Bas Ording	
				Art Unit		3992	
				Examiner Name		BONSHOCK, DENNIS G	
Sheet	5	of	8	Attorney Docket Number		P4304USREX2/12073 0-002US	

FOREIGN PATENT DOCUMENTS						
Examiner Initials	Cite No.	Foreign Patent Document Country Code <sup>3</sup> - Number <sup>4</sup> - Kind Code <sup>5</sup> (if known)	Publication Date MM-DD- YYYY	Name of Patentee or Applicant of Cited Document	Pages, Columns, Lines, Where Relevant Passages or Relevant Figures Appear	T <sup>6</sup>
	FP1	EP 0 626 635 A2	11-30-1994	Firstperson, Inc.		
	FP2	WO 01/29702 A2	04-26-2001	Koninklijke Philips Electronics N.V.		
	FP3	WO 01/77792 A2	10-18-2001	RSA Security Inc.		
	FP4	WO 02/21338 A2	03-14-2002	Oracle Corporation		
	FP5	WO 03/081458 A1	10-02-2003	America Online Inc		
	FP6	WO 04/001560 A1	12-31-2003	Nokia Corporation		
	FP7	WO 06/045530 A2	05-04-2006	Novo Nordisk A/S		
NON PATENT LITERATURE DOCUMENTS						
Examiner Initials	Cite No.	Include name of the author (in CAPITAL LETTERS), title of the article (when appropriate), title of the item (book, magazine, journal, serial, symposium, catalog, etc.), date, page(s), volume-issue number(s), publisher, city and/or country where published				
	NPL1	Apple Inc. vs. Samsung Electronics Co. Ltd. et al., Judgment dated August 24, 2011, 65 pages.				
	NPL2	Apple Inc. vs. Samsung Electronics Co. Ltd., et al., Samsung's Patent Local Rule 3-3 and 3-4 Disclosures dated October 7, 2011, together with Exhibits G-1 through G-7 and Exhibit H, 287 pages.				
	NPL3	Apple Inc. vs. Samsung Electronics Co. Ltd., et al., Samsung's Motion To Supplement Invalidity Contentions filed January 27, 2012 together with Exhibit 6, 47 pages.				
	NPL4	Ballard, P., "Microsoft Makes Research Technologies Available For Licensing," May 5, 2005, <a href="http://www.theserveside.com/discussions/thread.tss?thread_id=33761">http://www.theserveside.com/discussions/thread.tss?thread_id=33761</a> , 8 pages.				
	NPL5	Benko et al., "Precise Selection Techniques for Multi-Touch Screens," CHI 2006, April 22-27 2006, 10 pages.				
	NPL6	Certificate of Grant dated February 3, 2012, received in Hong Kong Patent Application No. 10103983.1, which corresponds to U.S. Application No. 11/956,969, 5 pages (Ording)				
	NPL7	Davis, J., "Flash to the Core-An Interactive Sketchbook, praystation.com. 2002, <a href="http://flashtothecore.praystation.com/">http://flashtothecore.praystation.com/</a> , 3 pages.				
	NPL8	Decision to Grant dated October 7, 2011, received in European Patent Application No. 08 713 567.9, which corresponds to U.S. Application No. 11/956,969 (Ording).				

Examiner Signature	Date Considered
--------------------	-----------------

\*EXAMINER: Initial if reference considered, whether or not citation is in conformance with MPEP 609. Draw line through citation if not in conformance and not considered. Include copy of this form with next communication to applicant. <sup>1</sup> Applicant's unique citation designation number (optional). <sup>2</sup> See Kind Codes of USPTO Patent Documents at [www.uspto.gov](http://www.uspto.gov) or MPEP 901.04. <sup>3</sup> Enter Office that issued the document, by the two-letter code (WIPO Standard ST.3). <sup>4</sup> For Japanese patent documents, the indication of the year of the reign of the Emperor must precede the serial number of the patent document. <sup>5</sup> Kind of document by the appropriate symbols as indicated on the document under WIPO Standard ST. 16 if possible. <sup>6</sup> Applicant is to place a check mark here if English language Translation is attached.

Burden Hour Statement: This form is estimated to take 2.0 hours to complete. Time will vary depending upon the needs of the individual case. Any comments on the amount of time you are required to complete this form should be sent to the Chief Information Officer, U.S. Patent and Trademark Office, Washington, DC 20231. DO NOT SEND FEES OR COMPLETED FORMS TO THIS ADDRESS. SEND TO: Assistant Commissioner for Patents, P.O. Box 1450, Alexandria, VA 22313-1450.

<b>INFORMATION DISCLOSURE CITATION</b>  Substitute for Form 1449-PTO				<i>Electronically filed October 9, 2012</i>			
				Application Number		90/012,304	
				Filing Date		May 23, 2012	
				First Named Inventor		Bas Ording	
				Art Unit		3992	
Examiner Name		BONSHOCK, DENNIS G					
Sheet	6	of	8	Attorney Docket Number	P4304USREX2/12073 0-002US		

NPL9	Dodge et al., "Microsoft Office Excel 2003 Office Manual," Microsoft Press, July 12, 2004, vol. 1, p. 66-68, UNABLE TO LOCATE ENGLISH TRANSLATION.
NPL10	European Search Report dated December 1, 2011, received in European Patent Application No. 11182962.8, which corresponds to U.S. Application No. 11/956,969, 8 pages (Ording).
NPL11	European Search Report dated December 1, 2011, received in European Patent Application No. 11182963.6, which corresponds to U.S. Application No. 11/956,969, 8 pages (Ording).
NPL12	European Search Report dated November 30, 2011, received in European Patent Application No. 11182959.4, which corresponds to U.S. Application No. 11/956,969, 7 pages (Ording).
NPL13	European Search Report dated November 29, 2011, received in European Patent Application No. 11182954.5, which corresponds to U.S. Application No. 11/956,969, 6 pages (Ording).
NPL14	Examiner's Amendment dated October 29, 2008, to related application no. 11/956,969.
NPL15	Examiner's Report dated February 19, 2009, received in Australian Patent Application No. 2008201540, which corresponds to U.S. Application No. 11/956,969 (issued U.S. Patent No. 7,469,381).
NPL16	Examiner's Report dated July 15, 2009, received in Australian Patent Application No. 2008201540, which corresponds to U.S. Application No. 11/956,969 (issued U.S. Patent 7,469,381).
NPL17	Examiner's Report dated July 1, 2008, received in Australian Patent Application No. 2008100283, which corresponds to U.S. Application No. 11/956,969 (issued U.S. Patent 7,469,381).
NPL18	Examiner's Report dated April 8, 2010, received in Australian Patent Application No. 2009208103, which corresponds to U.S. Application No. 11/956,969, 2 pages (Ording).
NPL19	Examiner's Report dated February 11, 2009, received in Australian Patent Application No. 2009200366, which corresponds to U.S. Application No. 11/956,969 (issued U.S. Patent No. 7,469,381).
NPL20	Forlines, et al., "DTLens: Multi-user Tabletop Spatial Data Exploration," UIST '05, October 2005, Seattle Washington, USA, 6 pages.
NPL21	HAN, J., "Talks Jeff Han: Unveiling the Genius of Multi-touch Interface Design," Ted Ideas Worth Spreading, August 6, 2006, 1 page, <a href="http://www.ted.com/talks/lang/en/jeff_han_demos_his_breakthrough_touchscreen.html">http://www.ted.com/talks/lang/en/jeff_han_demos_his_breakthrough_touchscreen.html</a>
NPL22	HTC Europe Co. Ltd and Apple Inc. Invalidity Claim dated July 29, 2011, together with amended Particulars of Claim and amended Grounds of Invalidity, 22 pages.
NPL23	HTC Europe Co. Ltd and Apple Inc. Invalidity Claim dated April 5, 2012, together with annexes, 84 pages.
NPL24	Japanese patent issued May 20, 2011, for Japanese patent application no. 2009 544996, which corresponds to U.S. Application No. 11/956,969 (Ording).

Examiner Signature	Date Considered
--------------------	-----------------

\*EXAMINER: Initial if reference considered, whether or not citation is in conformance with MPEP 609. Draw line through citation if not in conformance and not considered. Include copy of this form with next communication to applicant. <sup>1</sup> Applicant's unique citation designation number (optional). <sup>2</sup> See Kind Codes of USPTO Patent Documents at [www.uspto.gov](http://www.uspto.gov) or MPEP 901.04. <sup>3</sup> Enter Office that issued the document, by the two-letter code (WIPO Standard ST.3). <sup>4</sup> For Japanese patent documents, the indication of the year of the reign of the Emperor must precede the serial number of the patent document. <sup>5</sup> Kind of document by the appropriate symbols as indicated on the document under WIPO Standard ST. 16 if possible. <sup>6</sup> Applicant is to place a check mark here if English language translation is attached.

Burden Hour Statement: This form is estimated to take 2.0 hours to complete. Time will vary depending upon the needs of the individual case. Any comments on the amount of time you are required to complete this form should be sent to the Chief Information Officer, U.S. Patent and Trademark Office, Washington, DC 20231. DO NOT SEND FEES OR COMPLETED FORMS TO THIS ADDRESS. SEND TO: Assistant Commissioner for Patents, P.O. Box 1450, Alexandria, VA 22313-1450.

<b>INFORMATION DISCLOSURE CITATION</b>  Substitute for Form 1449-PTO				<i>Electronically filed October 9, 2012</i>			
				Application Number		90/012,304	
				Filing Date		May 23, 2012	
				First Named Inventor		Bas Ording	
				Art Unit		3992	
Examiner Name		BONSHOCK, DENNIS G					
Sheet	7	of	8	Attorney Docket Number	P4304USREX2/12073 0-002US		

NPL25	KARLSON et al., "AppLens and LaunchTile: Two Designs for One-handed Thumb Use on Small Devices," CHI 2005 April 2-7, 2005, Portland, OR, pp.1-10
NPL26	MERTZ et al., "The influence of design techniques on user interfaces: the DigiStrips experiment for air traffic control," Proceeding of HCI-Aero 2000 International Conference on Human-Computer Interaction in Aeronautics, Toulouse, France, 6 pages.
NPL27	Motorola Mobility Opposition Grounds to Apple Inc. European Patent EP 2126678 dated April 11, 2012, together with Exhibits E3, E4, and E5 re: CHI 2005, April 2-7, 2005, Portland Oregon, USA, 53 pages.
NPL28	Notice of Acceptance dated November 24, 2011, received in Australian Patent Application No. 2009208099, which corresponds to U.S. Application No. 11/956,969, 3 pages (Ording).
NPL29	Notice of Acceptance dated April 14, 2011, received in Australian patent Application No. 2009208103, which corresponds to U.S. Application No. 11/956,969 (Ording).
NPL30	Notice of Acceptance dated November 9, 2011, received in Australian Patent Application No. 2011201639, which corresponds to U.S. Application No. 11/956,969, 3 pages (Ording).
NPL31	Notice of Appeal in Expedited Appeal in Summary Proceedings dated September 11, 2011, 51 pages.
NPL32	Notice of Allowance dated January 30, 2012, received in Canadian Patent Application No. 2,658,177, which corresponds to U.S. Application No. 11/956,969, 1 page (Ording)
NPL33	Notice of Allowance dated May 11, 2012, received in U.S. Application No. 12/270,807, 16 pages (Ording)
NPL34	Notice of Allowance dated July 11, 2012, for related application no. 12/270,810 (Ording).
NPL35	Notice of Allowance dated October 29, 2008, for related application no. 11/956,969 (Ording).
NPL36	Office Action dated May 17, 2012, received in U.S. Application No. 12/270,812, 18 pages (Ording)
NPL37	Office Action dated May 17, 2012, received in U.S. Application No. 12/270,815, 17 pages (Ording)
NPL38	Office Action dated October 11, 2011, received in U.S. Application No. 12/270,807 (Ording).
NPL39	Office Action dated October 12, 2011, received in U.S. Application No. 12/270,810 (Ording).
NPL40	Office Action dated October 13, 2011, received in U.S. Application No. 12/270,812 (Ording).
NPL41	Office Action dated October 11, 2011, received in U.S. Application No. 12/270,815 (Ording).
NPL42	Office Action dated December 1, 2009, received in Canadian Patent Application No. 2,658,177, which corresponds to U.S. Application 11/956,969 (issued U.S. Patent 7,469,381).
NPL43	Office Action dated January 5, 2012, received in Chinese Patent Application No. 200880000019.9, which corresponds to U.S. Application No. 11/956,969, 14 pages (Ording).
NPL44	Office Action dated November 23, 2010, received in Chinese Patent Application No. 200880000019.9, which corresponds to U.S. Application No. 11/956,969 (issued U.S. Patent 7,469,381).

Examiner Signature	Date Considered
--------------------	-----------------

\*EXAMINER: Initial if reference considered, whether or not citation is in conformance with MPEP 609. Draw line through citation if not in conformance and not considered. Include copy of this form with next communication to applicant. <sup>1</sup> Applicant's unique citation designation number (optional). <sup>2</sup> See Kind Codes of USPTO Patent Documents at [www.uspto.gov](http://www.uspto.gov) or MPEP 901.04. <sup>3</sup> Enter Office that issued the document, by the two-letter code (WIPO Standard ST.3). <sup>4</sup> For Japanese patent documents, the indication of the year of the reign of the Emperor must precede the serial number of the patent document. <sup>5</sup> Kind of document by the appropriate symbols as indicated on the document under WIPO Standard ST. 16 if possible. <sup>6</sup> Applicant is to place a check mark here if English language translation is attached.

Burden Hour Statement: This form is estimated to take 2.0 hours to complete. Time will vary depending upon the needs of the individual case. Any comments on the amount of time you are required to complete this form should be sent to the Chief Information Officer, U.S. Patent and Trademark Office, Washington, DC 20231. DO NOT SEND FEES OR COMPLETED FORMS TO THIS ADDRESS. SEND TO: Assistant Commissioner for Patents, P.O. Box 1450, Alexandria, VA 22313-1450.

<b>INFORMATION DISCLOSURE CITATION</b>  Substitute for Form 1449-PTO				<i>Electronically filed October 9, 2012</i>			
				Application Number		90/012,304	
				Filing Date		May 23, 2012	
				First Named Inventor		Bas Ording	
				Art Unit		3992	
Examiner Name		BONSHOCK, DENNIS G					
Sheet	8	of	8	Attorney Docket Number	P4304USREX2/12073 0-002US		

NPL45	Office Action dated October 29, 2010, received in German Patent Application No. DE 11 2008 000 144.8-53, which corresponds to U.S. Application No. 11/956,969 (issued U.S. Patent 7,469,381).
NPL46	Office Action dated December 29, 2009, received in European Application No. 08 713 567.9, which corresponds to U.S. Application No. 11/956,969 (issued U.S. Patent 7,469,381).
NPL47	Office Action dated February 12, 2010, received in Japanese Patent Application No. 2009-544996, which corresponds to U.S. Application No. 11/956,969 (issued U.S. Patent 7,469,381).
NPL48	Office Action dated November 8, 2010, received in Japanese Patent Application No. 2009-544996, which corresponds to U.S. Application No. 11/956,969 (issued U.S. Patent 7,469,381).
NPL49	Office Action dated August 27, 2009, received in Korean Patent Application No. 10-2009-7003574, which corresponds to U.S. Application No. 11/956,969 (issued patent no. 7,469,381).
NPL50	Plaisant et al., "Touchscreen Toggle Design," Proceedings of the Conference on Human Factors in Computing Systems, Addison Wesley, US, May 3, 1992, 2 pages.
NPL51	Pleading notes Mr B.J. Berghuis van Woortman dated August 10 and 11, 2010, 16 pages.
NPL52	Pleading notes Mr Kleemans, Mr Blomme and Mr Van Oorschot dated August 10, 2011, 35 pages.
NPL53	Salmoni, "The Zooming User Interface," Advogato, August 16, 2004, <a href="http://www.advogato.org/article/788.html">http://www.advogato.org/article/788.html</a> , 14 pages.
NPL54	Samsung Electronics GmbH/Apple Inc. Opposition dated January 30, 2012, 27 pages.
NPL55	Samsung Statement of Defense (Tablets) Also Counterclaim dated July 20, 2011, 44 pages.
NPL56	Samsung Statement of Defense (Smartphones) Also Counterclaim dated July 20, 2011, 48 pages.
NPL57	Summons dated October 28, 2011, received in European Patent Application No. 08705751.9, which corresponds to U.S. Application No. 11/968,059, 9 pages (Lamiroux).

Examiner Signature		Date Considered	
--------------------	--	-----------------	--

\*EXAMINER: Initial if reference considered, whether or not citation is in conformance with MPEP 609. Draw line through citation if not in conformance and not considered. Include copy of this form with next communication to applicant. <sup>1</sup> Applicant's unique citation designation number (optional). <sup>2</sup> See Kind Codes of USPTO Patent Documents at [www.uspto.gov](http://www.uspto.gov) or MPEP 901.04. <sup>3</sup> Enter Office that issued the document, by the two-letter code (WIPO Standard ST.3). <sup>4</sup> For Japanese patent documents, the indication of the year of the reign of the Emperor must precede the serial number of the patent document. <sup>5</sup> Kind of document by the appropriate symbols as indicated on the document under WIPO Standard ST. 16 if possible. <sup>6</sup> Applicant is to place a check mark here if English language Translation is attached.

Burden Hour Statement: This form is estimated to take 2.0 hours to complete. Time will vary depending upon the needs of the individual case. Any comments on the amount of time you are required to complete this form should be sent to the Chief Information Officer, U.S. Patent and Trademark Office, Washington, DC 20231. DO NOT SEND FEES OR COMPLETED FORMS TO THIS ADDRESS. SEND TO: Assistant Commissioner for Patents, P.O. Box 1450, Alexandria, VA 22313-1450.

IN THE UNITED STATES PATENT AND TRADEMARK OFFICE

In re: Reexam of U.S. Patent No. 7,469,381 B2	Confirmation No.: 4807
Control No. 90/012,304	Art Unit: 3992
Filed: May 23, 2012	Examiner: Bonshock, Dennis G
For: <b>LIST SCROLLING AND DOCUMENT TRANSLATION, SCALING, AND ROTATION ON A TOUCH-SCREEN DISPLAY</b>	Atty. Docket: : P4304USREX2/120730-002US

**Certificate of Service**

Mail Stop *Ex Parte* Reexam  
Central Reexamination Unit  
Commissioner for Patents  
United States Patent and Trademark Office  
P.O. Box 1450  
Alexandria, VA 22313-1450

October 9, 2012

Sir:

In compliance with 37 C.F.R. § 1.550(f), the undersigned, on behalf of the Patent Owner, hereby certifies that copies of the following documents are being served on the Third Party Requester by first class mail on October 9, 2012.

1. Information Disclosure Statement citing documents US1-US71; USA1-USA66; FP1-FP7 and NPL1-NPL57;
2. Copies of cited documents FP1-FP7 and NPL1-NPL57 (on a disc);
3. Certificate of Service

The name and address of the party being served is as follows:

Joseph J. Richetti  
BRYAN CAVE LLP  
1290 Avenue of the Americas  
New York, New York 10104

Very truly yours,

/Kenneth J. Weatherwax/  
Kenneth J. Weatherwax, Reg. No. 54,528  
Goldberg, Lowenstein & Weatherwax LLP

**Electronic Acknowledgement Receipt**

<b>EFS ID:</b>	13946362
<b>Application Number:</b>	90012304
<b>International Application Number:</b>	
<b>Confirmation Number:</b>	4807
<b>Title of Invention:</b>	LIST SCROLLING AND DOCUMENT TRANSLATION, SCALING, AND ROTATION ON A TOUCH-SCREEN DISPLAY
<b>First Named Inventor/Applicant Name:</b>	7,469,381
<b>Customer Number:</b>	61725
<b>Filer:</b>	Kenneth James Weatherwax
<b>Filer Authorized By:</b>	
<b>Attorney Docket Number:</b>	P4304USREX2/063266-5682US
<b>Receipt Date:</b>	09-OCT-2012
<b>Filing Date:</b>	23-MAY-2012
<b>Time Stamp:</b>	21:35:55
<b>Application Type:</b>	Reexam (Third Party)

**Payment information:**

Submitted with Payment	no
------------------------	----

**File Listing:**

Document Number	Document Description	File Name	File Size(Bytes)/ Message Digest	Multi Part /.zip	Pages (if appl.)
1	Transmittal Letter	P4304REX2_IDS1_trans_letter_1.pdf	158761 ef7d5900caa547b4156d050c0248f556b1109708	no	2

**Warnings:****Information:**



2	Information Disclosure Statement (IDS) Form (SB08)	2012-10-09_7-469-381_IDS_FI NAL_1.pdf	7749800 d9279f75f0770afd9739675db6ce255b42f8e97c	no	8
<b>Warnings:</b>					
<b>Information:</b>					
This is not an USPTO supplied IDS fillable form					
3	Reexam Certificate of Service	381_Certificate_of_Ser_IDS_1. pdf	269415 1ab20aeca64d1326682d62b2a0837c0743c91735	no	1
<b>Warnings:</b>					
<b>Information:</b>					
4	Foreign Reference	EP0626635.pdf	620097 187ad197b8da4146858dc3c5c2300c69e761d3d1	no	54
<b>Warnings:</b>					
<b>Information:</b>					
5	Foreign Reference	WO_02-21338_Oracle.pdf	2859704 c7e0c429330b51e4aaf8c9e169887c73261e329	no	55
<b>Warnings:</b>					
<b>Information:</b>					
6	Foreign Reference	WO0129702.pdf	652684 9993d1cc15fe99250a32ad9454f386481df46a65	no	12
<b>Warnings:</b>					
<b>Information:</b>					
7	Foreign Reference	WO0177792A2.pdf	1281644 e6ec120d900be29b3a8ba1f9452883a1785c4a6f	no	27
<b>Warnings:</b>					
<b>Information:</b>					
8	Foreign Reference	WO03081458.pdf	1129008 32eb7d23f88d26aec1c50581f7d9372cfe7ac67f	no	65
<b>Warnings:</b>					
<b>Information:</b>					
9	Foreign Reference	WO04001560.pdf	1517575 75fe39c3e486c3c8010d01d5d01f187ecf593360	no	31
<b>Warnings:</b>					
<b>Information:</b>					
10	Foreign Reference	WO06045530.pdf	547140 955752efd92350ebffeb60dec6e3ec89bf17fa69	no	14

<b>Warnings:</b>					
<b>Information:</b>					
11	Non Patent Literature	5054_Grant_HK04_020312.pdf	593842 01b5349698db65a2df8f214e579ed92ae78155aa	no	5
<b>Warnings:</b>					
<b>Information:</b>					
12	Non Patent Literature	Apple-Inc-vs-Samsung_Judgment_082411.pdf	3959626 874c14696e76f9ca0756ff9e941f7273d3ee1c50	no	65
<b>Warnings:</b>					
<b>Information:</b>					
13	Non Patent Literature	Apple-Inc-vs-SamsungsPLR_100711.pdf	4912870 a6b8e1de6d06e71fa0ce706319b2a66e090d2adc	no	287
<b>Warnings:</b>					
<b>Information:</b>					
14	Non Patent Literature	Apple-vs-Samsung_motioniosupp.pdf	2445084 61136c2de49e06dd693720da56501f6c736ec46d	no	47
<b>Warnings:</b>					
<b>Information:</b>					
15	Non Patent Literature	Ballard_microsoft.pdf	193540 dfb5122d4f2a343191c7a02c471a8b96df185dd9	no	8
<b>Warnings:</b>					
<b>Information:</b>					
16	Non Patent Literature	Benko_precise-selection.pdf	1145271 0b8169b7b4055f2b9997fd99b9509ddf93445e39	no	10
<b>Warnings:</b>					
<b>Information:</b>					
17	Non Patent Literature	Davis.pdf	391192 5515acc7ef1372280a4c2c53526ea4be0e345d2b	no	3
<b>Warnings:</b>					
<b>Information:</b>					
18	Non Patent Literature	Decision-to-GrantEP-100711.pdf	467952 da4479a073da7d84fbb614a3d330e387875efd77	no	1
<b>Warnings:</b>					
<b>Information:</b>					
19	Non Patent Literature	Dodge-etal_Microsoft-Office-Excel2003.pdf	285178 4b169c9bd6e5568e55447e5f5ae1eb6ed74b1c3	no	5

<b>Warnings:</b>					
<b>Information:</b>					
20	Non Patent Literature	EP-Search-Rpt-112911.pdf	625956 9d1e8f5328cd28a0279ce5269a1ad4013094eacc	no	6
<b>Warnings:</b>					
<b>Information:</b>					
21	Non Patent Literature	EP-Search-Rpt-113011.pdf	298286 83065c4ad303b4bc2af2d63fb26acda829f58de6	no	7
<b>Warnings:</b>					
<b>Information:</b>					
22	Non Patent Literature	EP-Search-Rpt11182962_120111.pdf	175945 714cbbdaa790c167e2249c79af7d47f965ea0e4ec	no	8
<b>Warnings:</b>					
The page size in the PDF is too large. The pages should be 8.5 x 11 or A4. If this PDF is submitted, the pages will be resized upon entry into the Image File Wrapper and may affect subsequent processing					
<b>Information:</b>					
23	Non Patent Literature	EP-Search-Rpt11182963_120111.pdf	766755 6fe754da274e976cd4be2c7a41860b26b6fa1b5e	no	8
<b>Warnings:</b>					
<b>Information:</b>					
24	Non Patent Literature	Examiners-amendment-102908.pdf	642627 80d4f4ab98d5696a5eadbb62ccf56fa4695e7360	no	13
<b>Warnings:</b>					
<b>Information:</b>					
25	Non Patent Literature	Examiners-reportAU-021109.pdf	189657 8deae6bbfd917e38268a37aec73fd3e37e623d	no	4
<b>Warnings:</b>					
<b>Information:</b>					
26	Non Patent Literature	Examiners-reportAU-021909.pdf	72946 c5fce9df1ed1765e7548ba83fd391c17018aea2b	no	2
<b>Warnings:</b>					
<b>Information:</b>					
27	Non Patent Literature	Examiners-reportAU-040810.pdf	93691 8fe33c356b21368e3a370c30caab15eb4163008c	no	2
<b>Warnings:</b>					
<b>Information:</b>					

28	Non Patent Literature	Examiners-reportAU-070108.pdf	67011 cc8dba0f5b3eb02083bb637f55f6807d18cd51a9	no	2
<b>Warnings:</b>					
<b>Information:</b>					
29	Non Patent Literature	Examiners-reportAU-071509.pdf	70147 7c17c7654b2b6da142d09eedc6ac79a677ab9ce4	no	2
<b>Warnings:</b>					
<b>Information:</b>					
30	Non Patent Literature	forlines_dt lens.pdf	243766 d3bf40334869224435573e3ed22fb278eb588b1f	no	6
<b>Warnings:</b>					
<b>Information:</b>					
31	Non Patent Literature	Han_Talks_Jeff.pdf	103151 390bde3d1ea42cb09bc20165e7d8663ca73f05f5	no	1
<b>Warnings:</b>					
<b>Information:</b>					
32	Non Patent Literature	HTC_invalid ityclaim.pdf	5289446 a15c7b60bc8ca746594edfab349fcd5a2f55c89c	no	84
<b>Warnings:</b>					
<b>Information:</b>					
33	Non Patent Literature	HTC_invalid ityclaim_040512.pdf	5289446 a15c7b60bc8ca746594edfab349fcd5a2f55c89c	no	84
<b>Warnings:</b>					
<b>Information:</b>					
34	Non Patent Literature	Japanese-patent-issued-052011.pdf	49046 a30fce1252168d569b4dea1615b1a4efc84b704	no	1
<b>Warnings:</b>					
<b>Information:</b>					
35	Non Patent Literature	Karlson-et al_ApplLens.pdf	1113352 409da27c269c05053b64a213549c7701bb13cef b	no	10
<b>Warnings:</b>					
<b>Information:</b>					
36	Non Patent Literature	Mertz.pdf	789475 b83e28e7a25e9fc7a9a5e835120bc35f6fe9fb6	no	6
<b>Warnings:</b>					
<b>Information:</b>					

37	Non Patent Literature	Motorola_Mobility_Opposition.pdf	4420549 4d369682ecc7f948753759e3db8d42425e a6a7c	no	53
----	-----------------------	----------------------------------	--	----	----

**Warnings:****Information:****Total Files Size (in bytes):**

51481635

**This Acknowledgement Receipt evidences receipt on the noted date by the USPTO of the indicated documents, characterized by the applicant, and including page counts, where applicable. It serves as evidence of receipt similar to a Post Card, as described in MPEP 503.**

**New Applications Under 35 U.S.C. 111**

**If a new application is being filed and the application includes the necessary components for a filing date (see 37 CFR 1.53(b)-(d) and MPEP 506), a Filing Receipt (37 CFR 1.54) will be issued in due course and the date shown on this Acknowledgement Receipt will establish the filing date of the application.**

**National Stage of an International Application under 35 U.S.C. 371**

**If a timely submission to enter the national stage of an international application is compliant with the conditions of 35 U.S.C. 371 and other applicable requirements a Form PCT/DO/EO/903 indicating acceptance of the application as a national stage submission under 35 U.S.C. 371 will be issued in addition to the Filing Receipt, in due course.**

**New International Application Filed with the USPTO as a Receiving Office**

**If a new international application is being filed and the international application includes the necessary components for an international filing date (see PCT Article 11 and MPEP 1810), a Notification of the International Application Number and of the International Filing Date (Form PCT/RO/105) will be issued in due course, subject to prescriptions concerning national security, and the date shown on this Acknowledgement Receipt will establish the international filing date of the application.**

**IN THE UNITED STATES PATENT AND TRADEMARK OFFICE**

**Reexam Application No.:** 90/012,304  
**For:** US 7,469,381 B2  
**Filing Date:** 05-23-2012  
**Art Unit:** 3992  
**Examiner:** BONSHOCK, DENNIS G.  
**Attorney Docket No.:** P4304USREX2/120730-002US

**INFORMATION DISCLOSURE STATEMENT**

Mail Stop *Ex Parte Reexam*  
Central Reexamination Unit  
Commissioner for Patents  
P.O. Box 1450  
Alexandria, VA 22313-1450

Sir:

In accordance with the duty of disclosure provisions of 37 C.F.R. §1.56, there is hereby provided certain information which the Examiner may consider material to the reexamination of the subject U.S. patent. It is requested that the Examiner make this information of record if it is deemed material to the reexamination.

Enclosures accompanying this Information Disclosure Statement are:

- a. A list of all patents, publications, applications, or other information submitted for consideration by the office
- b. A legible copy of:
  - Each foreign patent;
  - Each publication or that portion which caused it to be listed on PTO-1449; and
  - all other information or portion which caused it to be listed on the PTO-1449
- c. if included, an English language copy search report(s) from a counterpart foreign application or PCT International search report.

This Information Disclosure Statement is filed under 37 C.F.R. §1.97(b)(3), before the mailing of first Office action on the merits. It is accordingly believed that no fee is required. If any fee is deemed required, the Commissioner is authorized to charge any additional fee required for this Information Disclosure Statement to Goldberg, Lowenstein & Weatherwax LLP Deposit Account No. 50-5927 (order no. 120730-001US).

Copies of each cited U.S. patent and each U.S. patent application publication are not enclosed, pursuant to the USPTO OG Notice dated 05 August 2003, waiving the requirement under 37 C.F.R. 1.98(a)(2)(i) for U.S. patent applications filed after June 30, 2003.

No admission is made that the information cited in this Statement is, or is considered to be, material to patentability nor a representation that a search has been made (other than a search report of a foreign counterpart application or PCT International Search Report if submitted herewith). 37 C.F.R. §§1.97(g) and (h).

Date: October 9, 2012

Respectfully Submitted,

/Kenneth J. Weatherwax/  
Kenneth J. Weatherwax (Reg. No. 54,528)  
Goldberg, Lowenstein & Weatherwax LLP  
1925 Century Park East, Suite 2120  
Los Angeles, California 90067  
(310) 203-9344