

EXHIBIT A-3



UNITED STATES PATENT AND TRADEMARK OFFICE

UNITED STATES DEPARTMENT OF COMMERCE
 United States Patent and Trademark Office
 Address: COMMISSIONER FOR PATENTS
 P.O. Box 1450
 Alexandria, Virginia 22313-1450
 www.uspto.gov

| APPLICATION NO. | FILING DATE | FIRST NAMED INVENTOR | ATTORNEY DOCKET NO. | CONFIRMATION NO. |
|-----------------|-------------|----------------------|---------------------------|------------------|
| 90/012,304 | 05/23/2012 | 7,469,381 | P4304USREX2/063266-5682US | 4807 |

61725 7590 10/15/2012
 Morgan Lewis & Bockius LLP/ AI
 2 Palo Alto Square
 3000 El Camino Real, Suite 700
 Palo Alto, CA 94306

| |
|----------|
| EXAMINER |
|----------|

BONSHOCK, DENNIS G

| | |
|----------|--------------|
| ART UNIT | PAPER NUMBER |
|----------|--------------|

3992

| | |
|-----------|---------------|
| MAIL DATE | DELIVERY MODE |
|-----------|---------------|

10/15/2012

PAPER

Please find below and/or attached an Office communication concerning this application or proceeding.

The time period for reply, if any, is set in the attached communication.



UNITED STATES PATENT AND TRADEMARK OFFICE

Commissioner for Patents
United States Patent and Trademark Office
P.O. Box 1450
Alexandria, VA 22313-1450
www.uspto.gov

DO NOT USE IN PALM PRINTER

(THIRD PARTY REQUESTER'S CORRESPONDENCE ADDRESS)

BRYAN CAVE LLP

1290 AVENUE OF THE AMERICAS

NEW YORK, NY 10104

EX PARTE REEXAMINATION COMMUNICATION TRANSMITTAL FORM

REEXAMINATION CONTROL NO. 90/012,304.

PATENT NO. 7,469,381.

ART UNIT 3992.

Enclosed is a copy of the latest communication from the United States Patent and Trademark Office in the above identified *ex parte* reexamination proceeding (37 CFR 1.550(f)).

Where this copy is supplied after the reply by requester, 37 CFR 1.535, or the time for filing a reply has passed, no submission on behalf of the *ex parte* reexamination requester will be acknowledged or considered (37 CFR 1.550(g)).

| | | |
|--|-----------------------------|---|
| Office Action in Ex Parte Reexamination | Control No. 90/012,304 | Patent Under Reexamination 7,469,381 |
| | Examiner DENNIS BONSHOCK | Art Unit 3992 |

-- The MAILING DATE of this communication appears on the cover sheet with the correspondence address --

- a Responsive to the communication(s) filed on _____. b This action is made FINAL.
c A statement under 37 CFR 1.530 has not been received from the patent owner.

A shortened statutory period for response to this action is set to expire 2 month(s) from the mailing date of this letter. Failure to respond within the period for response will result in termination of the proceeding and issuance of an *ex parte* reexamination certificate in accordance with this action. 37 CFR 1.550(d). **EXTENSIONS OF TIME ARE GOVERNED BY 37 CFR 1.550(c).** If the period for response specified above is less than thirty (30) days, a response within the statutory minimum of thirty (30) days will be considered timely.

Part I THE FOLLOWING ATTACHMENT(S) ARE PART OF THIS ACTION:

1. Notice of References Cited by Examiner, PTO-892. 3. Interview Summary, PTO-474.
2. Information Disclosure Statement, PTO/SB/08. 4. _____.

Part II SUMMARY OF ACTION

- 1a. Claims 1-20 are subject to reexamination.
1b. Claims _____ are not subject to reexamination.
2. Claims _____ have been canceled in the present reexamination proceeding.
3. Claims _____ are patentable and/or confirmed.
4. Claims 1-20 are rejected.
5. Claims _____ are objected to.
6. The drawings, filed on _____ are acceptable.
7. The proposed drawing correction, filed on _____ has been (7a) approved (7b) disapproved.
8. Acknowledgment is made of the priority claim under 35 U.S.C. § 119(a)-(d) or (f).
a) All b) Some* c) None of the certified copies have
1 been received.
2 not been received.
3 been filed in Application No. _____.
4 been filed in reexamination Control No. _____.
5 been received by the International Bureau in PCT application No. _____.
* See the attached detailed Office action for a list of the certified copies not received.
9. Since the proceeding appears to be in condition for issuance of an *ex parte* reexamination certificate except for formal matters, prosecution as to the merits is closed in accordance with the practice under *Ex parte* Quayle, 1935 C.D. 11, 453 O.G. 213.
10. Other: _____

cc: Requester (if third party requester)

Application/Control Number: 90/012,304
Art Unit: 3992

Page 2

NON-FINAL OFFICE ACTION

***ex parte* Reexamination**

This is an *ex parte* reexamination of U.S. Patent Number: 7,469,381. This action addresses patent claims 1-20 for which it has been determined in the Order Granting *ex parte* Reexamination mailed 7-25-2012 that a substantial new question of patentability was raised in the Request for *ex parte* reexamination filed 5-23-2012.

Availability of References as Prior Art:

Claims 1-20 are reexamined on the basis of the following references:

Lira – PCT Publication no. WO 03/081458 by Luigi Lira

Ording '975 - U.S. Patent No. 7,786,975 issued to Ording et al.

Van Den Hoven – PCT Publication no. WO 01/029702 by Elise A. W. H. Van Den

Hoven

Rejections:

The following rejections are utilized by the Examiner below, referencing the proposed prior art listed on pages 23-85 of the Request:

Rejection A: Claims 1-6, 8-12, 16, 19, and 20 as being anticipated by Lira

Rejection B: Claims 7 and 13-15 as being obvious over Lira

Rejection D: Claims 1-5, 7-13, and 15-20 as being anticipated by Ording

Application/Control Number: 90/012,304

Page 3

Art Unit: 3992

REJECTIONS OVER LIRA

With respect to the following rejections over Lira, the "edge of the electronic document" has been shown to be capable of being construed as an internal edge, as opposed to being limited to the outer edge of a document as a whole. The Courts agree with the Examiner's independently formulated interpretation, as can be seen in the April 4, 2012 Order Construing Disputed Claim Terms of the '381 Patent issued by the Federal District Court for the Northern District of California in *Apple Inc. v. Samsung Elecs. Co.*, 5:11-CV-01846-LHK, ECF No. 849 (Exhibit 7), where it was decided that "an electronic document can be embedded in another electronic document, and there for the "edge of an electronic document" is not limited to "external" edges." Under Lira, whole documents (webpages) further contain individual images and column based text portions (see page 11, line 27 through column 12, line 2 and in figure 8A), that are internal to the webpage as a whole, where bounce back is effected responsive to the window being misaligned with the column based sub-document content (see page 15, lines 18-31). Furthermore, under Lira, the column in which the display window is located over could be an outside column where when the window is moved away from the document and over an outside boundary, the bounce back could be responsive to the document as a whole, moving from the whitespace on the top, bottom, and sides of the webpage back over the webpage.

REJECTION A:

Application/Control Number: 90/012,304

Page 4

Art Unit: 3992

Claim Rejections - 35 USC § 102

The following is a quotation of the appropriate paragraphs of 35 U.S.C. 102 that form the basis for the rejections under this section made in this Office action:

A person shall be entitled to a patent unless –

(b) the invention was patented or described in a printed publication in this or a foreign country or in public use or on sale in this country, more than one year prior to the date of application for patent in the United States.

Claims 1-6, 8-12, 16, 19, and 20 are rejected under 35 U.S.C. 102(b) as being anticipated by Lira.

The following claim mappings in the Request are incorporated by reference:

Claims 1-6 (Request Pages 23-38, Exhibit 6, Part A, Pages 1-18)

Claims 8-12 (Request Pages 39-41, Exhibit 6, Part A, Pages 21-24)

Claim 16 (Request Pages 42-43, Exhibit 6, Part A, Page 26)

Claims 19-20 (Request Pages 26-37, Exhibit 6, Part A, Pages 26-30)

REJECTION B:

Claim Rejections - 35 USC § 103

The following is a quotation of 35 U.S.C. 103(a) which forms the basis for all obviousness rejections set forth in this Office action:

(a) A patent may not be obtained though the invention is not identically disclosed or described as set forth in section 102 of this title, if the differences between the subject matter sought to be patented and the prior art are such that the subject matter as a whole would have been obvious at the time the invention was made to a person having ordinary skill in the art to which said subject matter pertains. Patentability shall not be negated by the manner in which the invention was made.

Application/Control Number: 90/012,304

Page 5

Art Unit: 3992

Claims 7 and 13-15 are rejected under 35 U.S.C. 103(a) as being unpatentable over Lira.

The following claim mappings in the Request are incorporated by reference:

Claims 7 (Request Pages 43-44, Exhibit 6, Part B, Pages 1-6)

Claims 13-15 (Request Pages 45-47, Exhibit 6, Part B, Pages 1-2, 6-9)

REJECTIONS OVER ORDING

REJECTION D:

Claim Rejections - 35 USC § 102

The following is a quotation of the appropriate paragraphs of 35 U.S.C. 102 that form the basis for the rejections under this section made in this Office action:

A person shall be entitled to a patent unless –

(b) the invention was patented or described in a printed publication in this or a foreign country or in public use or on sale in this country, more than one year prior to the date of application for patent in the United States.

Claims 1-5, 9-13, and 15-20 are rejected under 35 U.S.C. 102(b) as being anticipated by Ording '975.

The following claim mappings in the Request are incorporated by reference:

Claims 1-5 (Request Pages 61-77, Exhibit 6, Part D, Pages 1-20)

Claims 9-13 (Request Pages 78-80, Exhibit 6, Part D, Pages 22-27)

Claims 15-18 (Request Pages 80-85, Exhibit 6, Part D, Pages 27-36)

Application/Control Number: 90/012,304

Page 6

Art Unit: 3992

Claims 19-20 (Request Pages 61-77, Exhibit 6, Part D, Pages 33-38)

Summary

Claims 1-20 are rejected.

Litigation Reminder

The patent Owner is reminded of the continuing responsibility under 37 CFR 1.565(a) to apprise the Office of any litigation activity, or other prior or concurrent proceeding, involving Patent Number: 7,469,381 throughout the course of this reexamination proceeding. The third part requester is also reminded of the ability to similarly apprise the Office of any such activity or proceeding throughout the course of this reexamination proceeding. See MPEP §§ 2207, 2282 and 2286.

Response to this Action

In order to ensure full consideration of any amendments, affidavits, or declarations, or other document as evidence of patentability, such documents must be submitted in response to this Office Action. Submissions after the next Office Action, which is intended to be a Final Action, will be governed by the requirements of 37 CFR 1.116, after final rejection and 37 CFR 41.33 after appeal, which will be strictly enforced.

Application/Control Number: 90/012,304
Art Unit: 3992

Page 7

Conclusion

Extensions of time under 37 CFR 1.136(a) do not apply in reexamination proceedings. The provisions of 37 CFR 1.136 apply only to "an applicant" and not to parties in a reexamination proceeding. Further, in 35 U.S.C. 305 and in 37 CFR 1.550(a), it is required that reexamination proceedings "will be conducted with special dispatch within the Office."

The patent owner is reminded of the continuing responsibility under 37 CFR 1.565(a) to apprise the Office of any litigation activity, or other prior or concurrent proceeding, involving this patent throughout the course of this reexamination proceeding. The requester is also reminded of the ability to similarly appraise the Office of any such activity or proceeding throughout the course of this reexamination proceeding. See MPEP § § 2207, 2282, and 2286.

All correspondence relating to this *ex parte* reexamination proceeding should be directed:

By Mail to: Mail Stop Ex Parte Reexam
Central Reexamination Unit
Commissioner for Patents
United States Patent & Trademark Office
P.O. Box 1450
Alexandria, VA 22313-1450

Application/Control Number: 90/012,304

Page 8

Art Unit: 3992

By FAX to: (571) 273-9900

Central Reexamination Unit

By hand: Customer Service Window

Randolph Building

401 Dulany Street

Alexandria, VA 22314

By EFS-Web:

Registered users of EFS-Web may alternatively submit such correspondence via the electronic filing system EFS-Web, at

<https://efs.uspto.gov/efile/myportal/efs-registered>

EFS-Web offers the benefit of quick submission to the particular area of the Office that needs to act on the correspondence. Also, EFS-Web submissions are “soft scanned” (i.e., electronically uploaded) directly into the official file for the reexamination proceeding, which offers parties the opportunity to review the content of their submissions after the “soft scanning” process is complete.

Any inquiry concerning this communication or earlier communications from the Reexamination Legal Advisor or Examiner, or as to the status of this proceeding, should be directed to the Central Reexamination Unit at telephone number (571) 272-7705.

Application/Control Number: 90/012,304

Page 9

Art Unit: 3992

/Dennis G. Bonshock/

Primary Examiner, Art Unit 3992

/FOF/

ALEXANDER J. KOSOWSKI
Supervisory Patent Reexamination Specialist
CRU -- Art Unit 3992



| | | |
|--|--|---|
| Search Notes  | Application/Control No. 90012304 | Applicant(s)/Patent Under Reexamination 7,469,381 |
| | Examiner DENNIS BONSHOCK | Art Unit 3992 |

| | | | |
|-----------------|-----------------|-------------|-----------------|
| SEARCHED | | | |
| Class | Subclass | Date | Examiner |
| | | | |

| | | |
|---------------------------------------|-------------|-----------------|
| SEARCH NOTES | | |
| Search Notes | Date | Examiner |
| Reviewed Previous Prosecution History | 7-23-12 | dgb |
| Reviewed Previous Prosecution History | 10-9-12 | dgb |

| | | | |
|----------------------------|-----------------|-------------|-----------------|
| INTERFERENCE SEARCH | | | |
| Class | Subclass | Date | Examiner |
| | | | |

| | |
|--|--|
| | |
|--|--|

| | | |
|---|--|---|
| Reexamination  | Application/Control No. 90012304 | Applicant(s)/Patent Under Reexamination 7,469,381 |
| | Certificate Date | Certificate Number |

Requester Correspondence Address:
 Patent Owner
 Third Party

BRYAN CAVE LLP
 1290 AVENUE OF THE AMERICAS
 NEW YORK, NY 10104

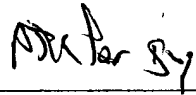
| | | |
|--|----------------------------|---|
| LITIGATION REVIEW <input checked="" type="checkbox"/> | DGB (examiner initials) | 07/23/2012 (date) |
| Case Name | | Director Initials |
| APPLE INC. v. SAMSUNG ELECTRONICS CO., LTD (N.D. CAL) Case N | |  |
| | | |
| | | |
| | | |
| | | |

| COPENDING OFFICE PROCEEDINGS | |
|------------------------------|--------|
| TYPE OF PROCEEDING | NUMBER |
| | |
| | |
| | |
| | |

| | |
|--|--|
| | |
|--|--|



UNITED STATES PATENT AND TRADEMARK OFFICE

UNITED STATES DEPARTMENT OF COMMERCE
United States Patent and Trademark Office
Address: COMMISSIONER FOR PATENTS
P.O. Box 1450
Alexandria, Virginia 22313-1450
www.uspto.gov

| APPLICATION NO. | FILING DATE | FIRST NAMED INVENTOR | ATTORNEY DOCKET NO. | CONFIRMATION NO. |
|-----------------|-------------|----------------------|---------------------------|------------------|
| 90/012,304 | 05/23/2012 | 7,469,381 | P4304USREX2/063266-5682US | 4807 |

61725 7590 10/26/2012
Morgan Lewis & Bockius LLP/ AI
2 Palo Alto Square
3000 El Camino Real, Suite 700
Palo Alto, CA 94306

EXAMINER

BONSHOCK, DENNIS G

| ART UNIT | PAPER NUMBER |
|----------|--------------|
| 3992 | |

| MAIL DATE | DELIVERY MODE |
|------------|---------------|
| 10/26/2012 | PAPER |

Please find below and/or attached an Office communication concerning this application or proceeding.

The time period for reply, if any, is set in the attached communication.



UNITED STATES PATENT AND TRADEMARK OFFICE

Commissioner for Patents
United States Patent and Trademark Office
P.O. Box 1450
Alexandria, VA 22313-1450
www.uspto.gov

DO NOT USE IN PALM PRINTER

(THIRD PARTY REQUESTER'S CORRESPONDENCE ADDRESS)

BRYAN CAVE LLP

1290 AVENUE OF THE AMERICAS

NEW YORK, NY 10104

EX PARTE REEXAMINATION COMMUNICATION TRANSMITTAL FORM

REEXAMINATION CONTROL NO. 90/012,304.

PATENT NO. 7,469,381.

ART UNIT 3992.

Enclosed is a copy of the latest communication from the United States Patent and Trademark Office in the above identified *ex parte* reexamination proceeding (37 CFR 1.550(f)).

Where this copy is supplied after the reply by requester, 37 CFR 1.535, or the time for filing a reply has passed, no submission on behalf of the *ex parte* reexamination requester will be acknowledged or considered (37 CFR 1.550(g)).



UNITED STATES DEPARTMENT OF COMMERCE

U.S. Patent and Trademark Office

Address : COMMISSIONER FOR PATENTS
P.O. Box 1450
Alexandria, Virginia 22313-1450

| APPLICATION NO./ CONTROL NO. | FILING DATE | FIRST NAMED INVENTOR / PATENT IN REEXAMINATION | ATTORNEY DOCKET NO. |
|---------------------------------|--------------|---|---------------------|
| 90/012,304 5682US | 23 May, 2012 | 7,469,381 | P4304USREX2/063266- |

| | | EXAMINER | |
|---|--|-----------------|----------|
| Morgan Lewis & Bockius LLP/ AI 2 Palo Alto Square 3000 El Camino Real, Suite 700 Palo Alto, CA 94306 | | DENNIS BONSHOCK | |
| | | ART UNIT | PAPER |
| | | 3992 | 20121023 |

DATE MAILED:

Please find below and/or attached an Office communication concerning this application or proceeding.

Commissioner for Patents

The Examiner notes that there was a typographical error on page 5 of the Non-Final Office Action mailed 10/15/12 in stating that the 102 rejection over Ording '975 was under 35 U.S.C. 102(b). The Rejection should have stated that "Claims 1-5, 9-13, and 15-20 are rejected under 35 U.S.C. 102(e) as being anticipated by Ording '975" in the heading, as well as have the appropriate 102(e) details displayed above that. This communication provides clarification as the proper section was provided in the incorporated by reference section just below the heading of the Non-Final Office Action.

/Alexander J Kosowski/
Supervisory Patent Examiner, Art Unit 3992

/Dennis G. Bonshock/
Primary Examiner, Art Unit 3992



UNITED STATES PATENT AND TRADEMARK OFFICE

UNITED STATES DEPARTMENT OF COMMERCE
 United States Patent and Trademark Office
 Address: COMMISSIONER FOR PATENTS
 P.O. Box 1450
 Alexandria, Virginia 22313-1450
 www.uspto.gov



Bib Data Sheet

CONFIRMATION NO. 4807

| | | | | |
|------------------------------------|---|---------------------|-------------------------------|---|
| SERIAL NUMBER 90/012,304 | FILING OR 371(c) DATE 05/23/2012 RULE | CLASS 715 | GROUP ART UNIT 3992 | ATTORNEY DOCKET NO. P4304USREX2/063266-5682US |
|------------------------------------|---|---------------------|-------------------------------|---|

APPLICANTS

7,469,381, Residence Not Provided;
 APPLE INC. (OWNER), CUPERTINO, CA;
 JOSEPH J. RICHETTI (3RD PTY. REQ.), NEW YORK, NY;
 BRYAN CAVE LLP, NEW YORK, NY

**** CONTINUING DATA *******

This application is a REX of 11/956,969 12/14/2007 PAT 7469381
 which claims benefit of 60/879,253 01/07/2007
 and claims benefit of 60/883,801 01/07/2007
 and claims benefit of 60/879,469 01/08/2007
 and claims benefit of 60/945,858 06/22/2007
 and claims benefit of 60/946,971 06/28/2007
 and claims benefit of 60/937,993 06/29/2007

**** FOREIGN APPLICATIONS *******

| | | | | | |
|---|-------------------------|-----------------------|---------------------------|--------------------------------|--|
| Foreign Priority claimed <input type="checkbox"/> yes <input type="checkbox"/> no | STATE OR COUNTRY | SHEETS DRAWING | TOTAL CLAIMS 20 | INDEPENDENT CLAIMS 3 | |
| 35 USC 119 (a-d) conditions met <input type="checkbox"/> yes <input type="checkbox"/> no <input type="checkbox"/> Met after Allowance | | | | | |
| Verified and Acknowledged | Examiner's Signature | Initials | | | |

ADDRESS

108491

TITLE

LIST SCROLLING AND DOCUMENT TRANSLATION, SCALING, AND ROTATION ON A TOUCH-SCREEN DISPLAY

| | | |
|------------------------------------|---|--|
| FILING FEE RECEIVED 2520 | FEES: Authority has been given in Paper No. _____ to charge/credit DEPOSIT ACCOUNT No. _____ for following: | <input type="checkbox"/> All Fees |
| | | <input type="checkbox"/> 1.16 Fees (Filing) |
| | | <input type="checkbox"/> 1.17 Fees (Processing Ext. of time) |
| | | <input type="checkbox"/> 1.18 Fees (Issue) |
| | | <input type="checkbox"/> Other _____ |
| | | <input type="checkbox"/> Credit |



UNITED STATES PATENT AND TRADEMARK OFFICE

UNITED STATES DEPARTMENT OF COMMERCE
 United States Patent and Trademark Office
 Address: COMMISSIONER FOR PATENTS
 P.O. Box 1450
 Alexandria, Virginia 22313-1450
 www.uspto.gov

| APPLICATION NUMBER | FILING OR 371(C) DATE | FIRST NAMED APPLICANT | ATTY. DOCKET NO./TITLE |
|--------------------|-----------------------|-----------------------|---------------------------|
| 90/012,304 | 05/23/2012 | 7,469,381 | P4304USREX2/063266-5682US |

CONFIRMATION NO. 4807

POWER OF ATTORNEY NOTICE

61725
 MORGAN, LEWIS & BOCKIUS LLP / AI
 2 PALO ALTO SQUARE
 3000 EL CAMINO REAL, SUITE 700
 PALO ALTO, CA 94306



Date Mailed: 11/15/2012

NOTICE REGARDING CHANGE OF POWER OF ATTORNEY

This is in response to the Power of Attorney filed 10/09/2012.

- The Power of Attorney to you in this application has been revoked by the assignee who has intervned as provided by 37 CFR 3.71. Future correspondence will be mailed to the new address of record(37 CFR 1.33).

/rbell/

Office of Data Management, Application Assistance Unit (571) 272-4000, or (571) 272-4200, or 1-888-786-0101



UNITED STATES PATENT AND TRADEMARK OFFICE

UNITED STATES DEPARTMENT OF COMMERCE
United States Patent and Trademark Office
 Address: COMMISSIONER FOR PATENTS
 P.O. Box 1450
 Alexandria, Virginia 22313-1450
 www.uspto.gov

| APPLICATION NUMBER | FILING OR 371(C) DATE | FIRST NAMED APPLICANT | ATTY. DOCKET NO./TITLE |
|--------------------|-----------------------|-----------------------|---------------------------|
| 90/012,304 | 05/23/2012 | 7,469,381 | P4304USREX2/063266-5682US |

108491
 Goldberg, Lowenstein & Weatherwax LLP
 1925 Century Park East
 Suite 2120
 Los Angeles, CA 90067

CONFIRMATION NO. 4807
POA ACCEPTANCE LETTER



Date Mailed: 11/15/2012

NOTICE OF ACCEPTANCE OF POWER OF ATTORNEY

This is in response to the Power of Attorney filed 10/09/2012.

The Power of Attorney in this application is accepted. Correspondence in this application will be mailed to the above address as provided by 37 CFR 1.33.

/rbell/

Office of Data Management, Application Assistance Unit (571) 272-4000, or (571) 272-4200, or 1-888-786-0101

IN THE UNITED STATES PATENT AND TRADEMARK OFFICE

In re: Ex Parte Reexamination of
U.S. Patent No. 7,469,381 B2 to Ording
Control No. 90/012,304

Reexam Request Filed: May 23, 2012

For: **LIST SCROLLING AND DOCUMENT
TRANSLATION, SCALING, AND
ROTATION ON A TOUCH-SCREEN
DISPLAY**

Confirmation No.: 4807

Group Art Unit: 3992

Examiner: Bonshock, Dennis G.

Atty. Docket:

P4304USREX2/120730-002US

**Patent Owner's Petition For Extension
Of Time Under 37 C.F.R. § 1.550(c)**

Mail Stop *Ex Parte* Reexam
Central Reexamination Unit
Commissioner for Patents
United States Patent and Trademark Office
P.O. Box 1450
Alexandria, VA 22313-1450

November 19, 2012

Sir:

Pursuant to 37 C.F.R. § 1.550(c), patent owner Apple Inc. hereby petitions for a one (1) month extension of time to reply to the first Office Action ("OA"), mailed October 15, 2012 and clarified by Office Communication mailed October 26, 2012, in the above case.

The current deadline with no extension is Monday, December 17, 2012. The requested deadline for response with a one month extension is **January 15, 2012**. The present petition is being filed with the petition fee specified under 37 C.F.R. § 1.17(g).

STATEMENT OF FACTS

1. On December 23, 2008, the patent at issue in this reexamination proceeding, U.S. Pat. No. 7,469,381 B2 ("381 Patent"), issued with 20 claims ("Issued Claims").
2. Patent Owner has filed infringement actions based on the '381 patent in two cases in the U.S. District Court for the District of Delaware and one case each in the Northern District of California and the U.S. International Trade Commission [Exhibit PE-1]. The WO 03/081458 A1 application ("*Lira*"), which forms a basis for rejections in the Office Action, is raised as an allegedly invalidating reference in at least the latter two cases. The California case resulted in a jury verdict on August 24, 2012 finding,

inter alia, the '381 Patent infringed and not invalid. The other U.S. cases are all the subject of settlement agreements and have either already been dismissed or will very shortly be the subject of motions to dismiss pursuant to settlement [Exhibit PE-2].

3. Patent Owner has filed foreign applications related to the '381 Patent application in at least six countries and the European Patent Office. Approximately twenty infringement litigation or opposition proceedings based on counterpart patents to the '381 patent are ongoing in six foreign countries, including Germany, Japan, Korea, the Netherlands, the United Kingdom and Australia [Ex. PE-1]. *Lira* is raised as an allegedly invalidating reference in all or virtually all of these foreign forums.
4. On April 28, 2010, a first request for ex parte reexamination (90/010,963) was filed at the Office in connection with the '381 Patent. On July 14, 2010, the Office issued a decision finding a substantial new question of patentability with respect to all Issued Claims on the basis of 5 references. The Office issued a first-action Notice of Intent to Issue Ex Parte Reexamination Certificate confirming the patentability of all 20 Issued claims on January 13, 2011, and issued that Certificate on April 26, 2011.
5. On May 23, 2012, this reexamination proceeding was initiated by the filing with the Office of an 86 page Request for Ex Parte Reexamination of the '381 Patent.
6. In this proceeding, on July 30, 2012, the Examiner mailed a 23 page decision ordering the reexamination of all 20 of the Issued Claims based on 3 references.
7. In this proceeding, on October 15, 2012, the Examiner mailed an Office Action entering non-final rejections of the 20 Issued Claims under reexamination based on two references, on two grounds of rejection for each claim except for claim 14, on stated grounds of § 102(b) and/or § 103(a). The Action incorporates by reference portions of and attachments to the Request For Ex Parte Reexamination totaling 163 pages (OA at 4, 5, 6), for a combined effective length of 172 pages.
8. In this proceeding, on October 23, 2012, the Examiner mailed a Communication noting that the Office Action erroneously stated the § 102 rejections of Claims 1-5, 9-13 and 15-20 over the *Ordling* '975 reference as under § 102(b) instead of (e).

DISCUSSION

An extension of time to respond to the first office action may be made only after the first office action on the merits in the reexamination is mailed and may be granted on a showing by the Patent Owner of "sufficient cause." 37 C.F.R. §1.550(c); M.P.E.P. § 2265. In making this determination, the Office balances the statutory requirement that the proceedings be conducted with special dispatch against "the desire to provide the patent owner with a fair opportunity to respond." M.P.E.P. § 2265.

Patent Owner appreciates the statutory requirement to proceed with special dispatch. However, the present *ex parte* reexamination is a complex proceeding involving multiple SNQs (SOF ¶¶ 5-6); an effectively 172-page office action that rejects all claims on multiple

bases and references and was corrected eleven days after mailing to change the stated basis for a rejection (SOF ¶¶ 7-8); and a patent and basis for rejection that have both been the subject of years of litigation in many domestic lawsuits and foreign counterpart litigation in at least nine forums in seven countries, all involving voluminous materials that must be gathered and reviewed (SOF ¶¶ 2-3). Furthermore, as explained below, Patent Owner is investigating and gathering support based on events over seven years ago for one or more Rule 131 declarations for signature, and one or more Rule 132 declarations for signature further supporting the novelty of the claims. The availability of declarants and counsel is significantly limited by the holiday season and international travel obligations. In spite of the diligent efforts and actions by the Patent Owner and its counsel to date, it has become clear that an additional one (1) month is needed to analyze and respond to the Office Action.

No extension of time has previously been requested in this proceeding.

I. The Office Action Included An Error That Went Unclarified For Eleven Days.

The Office Action mailed October 15, 2012 quotes § 102(b) and states that 16 Issued Claims “are rejected under 35 U.S.C. 102(b) as being anticipated by Ording ’975.” (OA at 5.) This rejection should have stated it was under § 102(e), not (b) (SOF ¶ 7). An Office Communication was mailed October 26, 2012 for the purpose of noting this error (SOF ¶ 8).

The eleven day delay in clarifying that this Office Action rejection is one that is susceptible to Rule 131 evidence contributed to the time needed to prepare such a response.

II. Additional Time Is Needed To Ensure Appraisal Of Prior And Concurrent Litigation Activities Under 37 C.F.R. § 1.565(a).

Reference is made to the statement set forth twice in the Office Action that “The Patent Owner is reminded of the continuing responsibility under 37 C.F.R. § 1.565(a) to apprise the Office of any litigation activity, or other prior or concurrent proceeding, involving Patent Number: 7,469,381 throughout the course of this reexamination proceeding” (OA at 6; *see also id.* at 7).

The effort required in this reexamination by Patent Owner and its counsel in this appraisal of prior and concurrent litigation activity is extraordinary because of the extraordinary amount of litigation activity pertaining to the subject matter of the patent in the Office Action. Four infringement suits based in part on the ’381 patent have been filed in the United States alone, one of which was recently the subject of a greater than \$1 billion jury verdict for infringement of the ’381 and other patents, one of which has already been

terminated by settlement, and two of which are the subject of a recent settlement agreement (SOF ¶ 2). What is more, many foreign counterpart patent applications have been filed in many other countries, and Patent Owner is involved in infringement litigation proceedings based on foreign counterparts to the '381 patent in six foreign countries, including Germany, Japan, Korea, the Netherlands, the United Kingdom, and Australia (SOF ¶ 3). A list of related litigations and oppositions, not including foreign prosecution, is attached [Ex. PE-1].

To prepare Patent Owner's response and satisfy its Rule 11.18(b) and other obligations in this proceeding, it is necessary to coordinate with more than a dozen law firms not involved in the reexamination, but representing Patent Owner in other proceedings involving the Patent or its counterparts, in order to collect and review many thousands of pages of documents written in at least four languages (and translations thereof), analyze them to determine what must be disclosed to the Office, determine which pertinent positions have been taken, and draft the response to be consistent with such positions. Many documents from the litigations have already been disclosed in the Information Disclosure Statement filed by Patent Owner on October 9, 2012. A supplemental IDS is in preparation.

The substantial effort required for this work is significantly increased by the fact that most of these worldwide litigations have involved assertions of at least the *Lira* reference relied upon by the Office Action as a basis for rejection. It is further greatly increased by the fact that Patent Owner and counsel in the various litigations are subject to significant differences in the scope of access to these materials as a result of differing confidentiality protections between the proceedings. The effort and time required are also increased by the need to avoid burdening the Office with voluminous immaterial documents. It is still further increased by the fact that litigation counsel in question are located in many non-English-speaking countries and spread across fourteen hours of time zones from Japan to Germany. Despite very diligent efforts, such collection and review efforts are still in progress.

III. Additional Time Is Needed For Preparation Of Rule 131 Affidavit Evidence.

The Office Action, as later clarified, enters a rejection of Claims 1-5, 9-13, and 15-20 under § 102(e) as being anticipated by *Ordling '975*. Patent Owner and its counsel are working diligently to investigate and assemble support for a Rule 131 Declaration in response to the § 102(e) rejection. An unusually long delay of over seven years has elapsed since the relevant time period for conception and reduction to practice, increasing the effort

needed to locate evidence supporting a declaration. Also, as noted below, the availability of the sole inventor, Mr. Ording, has been very limited in the period allowed for response.

IV. Additional Time Is Required For Preparation Of Rule 132 Affidavit Evidence.

Patent Owner is also preparing affidavits for signature under Rule 132 countering the many §§ 102(e) and 103(a) rejections. Such submissions have required a time-intensive process, including interaction with the inventor Mr. Ording, the finding and retention of one or more experts available to submit a declaration, and review by such declarants of the technology disclosed and claimed in the patent and the multiple grounds for rejection.

The time required for preparation of such Rule 132 evidence is increased by confidentiality and associated activity restrictions associated with the concurrent litigation proceedings, which impose limitations on which personnel, information, and counsel involved with the litigation may be involved with the reexamination. Indeed, for example, the expert retained by the Patent Owner who submitted testimony pertaining to the patent under reexamination in the United States litigation proceedings is restricted in connection with confidentiality orders from participation in reexamination proceedings.

V. The Availability Of Declarants During The Period For Response Is Limited.

The availability of the multiple persons expected to sign declarations accompanying the response or otherwise assist in supporting its preparation is being substantially limited by the holiday period and international travel. In particular, Mr. Ording, the sole inventor, has been and will be unavailable on foreign or domestic trips for large portions of the time between the time Patent Owner received the Office Action and the current December 17, 2012 due date for a response. This unavailability includes travel by Mr. Ording from October 21 to 31 and from December 7 to 10, and unavailability due to the main office of Patent Owner being shut down the entire week of November 18 to 24. Furthermore, as noted above, counsel availability is complicated by the fact, that as an unavoidable consequence of the worldwide litigation on this patent and its counterparts, counsel involved with one or more such proceedings include many law firms on numerous continents.

VI. The Patent Owner's rights to submit materials after this response are limited.

Reference is further made to the statement in the Office Action that, in light of intended strict enforcement of the provisions of 37 C.F.R. § 1.116, "[i]n order to ensure full consideration of any amendments, affidavits or declarations, or other documents as evidence of patentability, such documents must be submitted in response to this Office action" (OA at

6). The Patent Owner accordingly requests sufficient opportunity to complete its investigation and analysis before responding to the first Office Action on the merits.

VII. The Patent Owner's activity to date has been continuous and diligent.

As already set forth above in some detail, Patent Owner and its reexamination counsel have worked continuously and diligently in preparing the response to the Office Action and accompanying evidence. It is noted that the declaration of reexamination and Office Action modified the roster of proposed SNQs and accepted the proposed rejections only as to two of the three proposed references, which added to the complexity of forecasting the potential form of the Office Action. It is also noted that this proceeding is a "reexamination of a reexamination," M.P.E.P. § 2295, and that in the first reexamination (90/010,963), the first office action was a Notice Of Intent to Issue Reexamination Certificate confirming all claims (SOF ¶ 4). Nevertheless, between the July 30, 2012 Order Granting Reexamination and the October 19, 2012 receipt of the Office Action in the present second reexamination, substantial work was done with respect to the proposed rejections in the Request for Ex Parte Reexamination, including diligent work to become apprised of the facts associated with the patent file, Request, and concurrent domestic and foreign litigations and prosecutions; review and analysis of the proposed SNQs and rejections; study of the disclosure and references raised in the Request, analysis to the extent possible of the concurrent litigation proceedings; investigation of available declarants; and client and inventor meetings to work on and coordinate these tasks.

Pursuant to M.P.E.P. § 2265, details of events with respect to Patent Owner and its reexamination counsel since the Office Action was mailed is attached as Exhibit PE-3.

CONCLUSION AND RELIEF REQUESTED

Based on the foregoing, it is respectfully submitted that there is sufficient cause under 37 C.F.R. § 1.550(c) for a one (1) month extension of time, extending the time period to at least **January 15, 2012**, for Patent Owner to prepare its response to the pending Office Action and accompanying evidence. Such extension is hereby respectfully requested, and a favorable determination earnestly solicited.

Date: November 19, 2012

Respectfully Submitted,

/Kenneth J. Weatherwax/
Kenneth J. Weatherwax (Reg. No. 54,528)
Goldberg, Lowenstein & Weatherwax LLP

IN THE UNITED STATES PATENT AND TRADEMARK OFFICE

In re: Reexam of U.S. Patent No. 7,469,381 B2
Control No. 90/012,304
Filed: May 23, 2012
For: **LIST SCROLLING AND DOCUMENT
TRANSLATION, SCALING, AND
ROTATION ON A TOUCH-SCREEN
DISPLAY**

Confirmation No.: 4807
Art Unit: 3992
Examiner: Bonshock, Dennis G
Atty. Docket:
: P4304USREX2/120730-002US

Transmittal for Petition for Extension of Time

Mail Stop *Ex Parte* Reexam
Central Reexamination Unit
Commissioner for Patents
United States Patent and Trademark Office
P.O. Box 1450
Alexandria, VA 22313-1450

November 19, 2012

Sir:

Patent owner Apple Inc. ("Apple") hereby submits a petition requesting an extension of time to reply to the first Office Action, mailed October 15, 2012, in the above-captioned case. Enclosures accompanying this filing are:

1. Patent Owner's Petition for Extension of Time Under 37 C.F.R. § 1.550(c)
2. Exhibits PE-1 to PE-3
3. Certificate of Service

The petition for extension of time is accompanied by the \$200.00 petition fee required by 37 C.F.R. 1.17(g). If any additional fee is deemed required for this petition, the Commissioner is authorized to charge the additional fee to Deposit Account No. 50-5927.

Very truly yours,

/Kenneth J. Weatherwax/
Kenneth J. Weatherwax, Reg. No. 54,528
Goldberg, Lowenstein & Weatherwax LLP

IN THE UNITED STATES PATENT AND TRADEMARK OFFICE

In re: Reexam of U.S. Patent No. 7,469,381 B2
Control No. 90/012,304
Filed: May 23, 2012
For: **LIST SCROLLING AND DOCUMENT
TRANSLATION, SCALING, AND
ROTATION ON A TOUCH-SCREEN
DISPLAY**

Confirmation No.: 4807
Art Unit: 3992
Examiner: Bonshock, Dennis G
Atty. Docket:
: P4304USREX2/120730-002US

Certificate of Service

Mail Stop *Ex Parte* Reexam
Central Reexamination Unit
Commissioner for Patents
United States Patent and Trademark Office
P.O. Box 1450
Alexandria, VA 22313-1450

November 19, 2012

Sir:

In compliance with 37 C.F.R. §1.248, the undersigned, on behalf of the Patent Owner, hereby certifies that a copy of the following document is being served on the Third Party Requester by first class mail on November 19, 2012.

1. Patent Owner's Petition for Extension of Time Under 37 C.F.R. § 1.550(c)
2. Exhibits PE-1 to PE-3

The name and address of the party being served is as follows:

Joseph J. Richetti
BRYAN CAVE LLP
1290 Avenue of the Americas
New York, New York 10104

Very truly yours,

/Kenneth J. Weatherwax/
Kenneth J. Weatherwax, Reg. No. 54,528
Goldberg, Lowenstein & Weatherwax LLP

Electronic Patent Application Fee Transmittal

| | | | | |
|---|--|-----------------|---------------|-----------------------------|
| Application Number: | 90012304 | | | |
| Filing Date: | 23-May-2012 | | | |
| Title of Invention: | LIST SCROLLING AND DOCUMENT TRANSLATION, SCALING, AND ROTATION ON A TOUCH-SCREEN DISPLAY | | | |
| First Named Inventor/Applicant Name: | 7,469,381 | | | |
| Filer: | Kenneth James Weatherwax/Qing Ye | | | |
| Attorney Docket Number: | P4304USREX2/120730-002US | | | |
| Filed as Large Entity | | | | |
| ex parte reexam Filing Fees | | | | |
| Description | Fee Code | Quantity | Amount | Sub-Total in USD(\$) |
| Basic Filing: | | | | |
| Pages: | | | | |
| Claims: | | | | |
| Miscellaneous-Filing: | | | | |
| Petition: | | | | |
| Patent-Appeals-and-Interference: | | | | |
| Post-Allowance-and-Post-Issuance: | | | | |
| Extension-of-Time: | | | | |
| Petition fee- 37 CFR 1.17(g) (Group II) | 1463 | 1 | 200 | 200 |

| Description | Fee Code | Quantity | Amount | Sub-Total in USD(\$) |
|--------------------------|----------|----------|--------|----------------------|
| Miscellaneous: | | | | |
| Total in USD (\$) | | | | 200 |

Electronic Acknowledgement Receipt

| | |
|---|--|
| EFS ID: | 14270392 |
| Application Number: | 90012304 |
| International Application Number: | |
| Confirmation Number: | 4807 |
| Title of Invention: | LIST SCROLLING AND DOCUMENT TRANSLATION, SCALING, AND ROTATION ON A TOUCH-SCREEN DISPLAY |
| First Named Inventor/Applicant Name: | 7,469,381 |
| Customer Number: | 108491 |
| Filer: | Kenneth James Weatherwax/Qing Ye |
| Filer Authorized By: | Kenneth James Weatherwax |
| Attorney Docket Number: | P4304USREX2/120730-002US |
| Receipt Date: | 19-NOV-2012 |
| Filing Date: | 23-MAY-2012 |
| Time Stamp: | 19:36:28 |
| Application Type: | Reexam (Third Party) |

Payment information:

| | |
|--|-------------|
| Submitted with Payment | yes |
| Payment Type | Credit Card |
| Payment was successfully received in RAM | \$200 |
| RAM confirmation Number | 7927 |
| Deposit Account | |
| Authorized User | |

File Listing:

| Document Number | Document Description | File Name | File Size(Bytes)/ Message Digest | Multi Part /.zip | Pages (if appl.) |
|-----------------|----------------------|-----------|-------------------------------------|------------------|------------------|
|-----------------|----------------------|-----------|-------------------------------------|------------------|------------------|

| | | | | | |
|-------------------------------------|--------------------------------------|--|---|---------|---|
| 1 | Reexam Request for Extension of Time | 381_FINAL_Petition_for_Extension_1.pdf | 3188164 14a6e33e9cdd03afb6ed777e7575cb1f3b6a1e2 | no | 6 |
| Warnings: | | | | | |
| Information: | | | | | |
| 2 | Reexam Request for Extension of Time | 381_FINAL_Petition_for_Extension_ExPE-1.pdf | 298047 ff92278d9c3f65e54ee15e7203b34dc1ed433a71 | no | 2 |
| Warnings: | | | | | |
| Information: | | | | | |
| 3 | Reexam Request for Extension of Time | 381_FINAL_Petition_for_Extension_Ex_PE-2_1.pdf | 469817 700b974738ada77fce82f9bb378d6e5dabdee2a | no | 4 |
| Warnings: | | | | | |
| Information: | | | | | |
| 4 | Reexam Request for Extension of Time | 381_FINAL_Petition_for_Extension_ExPE-3_1.pdf | 581838 8e911e5edfbfd1362e2906124d241825bffe6c61 | no | 2 |
| Warnings: | | | | | |
| Information: | | | | | |
| 5 | Reexam Miscellaneous Incoming Letter | 381_CoverLetter_Petition_for_Extension_of_Time_1.pdf | 296974 ceda3b2662a6a740f753935647e9120ddeeb8a7c6 | no | 1 |
| Warnings: | | | | | |
| Information: | | | | | |
| 6 | Reexam Certificate of Service | 381_COS_Petition_for_Extension_of_Time_1.pdf | 257241 b08d85ba9d4c8c63264c6ecf7faf223bd91ac70e | no | 1 |
| Warnings: | | | | | |
| Information: | | | | | |
| 7 | Fee Worksheet (SB06) | fee-info.pdf | 30638 7dab09cc44123525c168323315957ec7f2d19e54 | no | 2 |
| Warnings: | | | | | |
| Information: | | | | | |
| Total Files Size (in bytes): | | | | 5122719 | |

This Acknowledgement Receipt evidences receipt on the noted date by the USPTO of the indicated documents, characterized by the applicant, and including page counts, where applicable. It serves as evidence of receipt similar to a Post Card, as described in MPEP 503.

New Applications Under 35 U.S.C. 111

If a new application is being filed and the application includes the necessary components for a filing date (see 37 CFR 1.53(b)-(d) and MPEP 506), a Filing Receipt (37 CFR 1.54) will be issued in due course and the date shown on this Acknowledgement Receipt will establish the filing date of the application.

National Stage of an International Application under 35 U.S.C. 371

If a timely submission to enter the national stage of an international application is compliant with the conditions of 35 U.S.C. 371 and other applicable requirements a Form PCT/DO/EO/903 indicating acceptance of the application as a national stage submission under 35 U.S.C. 371 will be issued in addition to the Filing Receipt, in due course.

New International Application Filed with the USPTO as a Receiving Office

If a new international application is being filed and the international application includes the necessary components for an international filing date (see PCT Article 11 and MPEP 1810), a Notification of the International Application Number and of the International Filing Date (Form PCT/RO/105) will be issued in due course, subject to prescriptions concerning national security, and the date shown on this Acknowledgement Receipt will establish the international filing date of the application.

UNITED STATES PATENT AND TRADEMARK OFFICE

UNITED STATES DEPARTMENT OF COMMERCE
 United States Patent and Trademark Office
 Address: COMMISSIONER FOR PATENTS
 P.O. Box 1450
 Alexandria, Virginia 22313-1450
 www.uspto.gov

| APPLICATION NO. | FILING DATE | FIRST NAMED INVENTOR | ATTORNEY DOCKET NO. | CONFIRMATION NO. | | | | |
|--|---------------|----------------------|--|------------------|-----------|---------------|--------------------|-------|
| 90/012,304 | 05/23/2012 | 7,469,381 | P4304USREX2/120730-002US | 4807 | | | | |
| 108491 | 7590 | 11/20/2012 | <table border="1"> <tr> <td colspan="2">EXAMINER</td> </tr> <tr> <td colspan="2">BONSHOCK, DENNIS G</td> </tr> </table> | | EXAMINER | | BONSHOCK, DENNIS G | |
| EXAMINER | | | | | | | | |
| BONSHOCK, DENNIS G | | | | | | | | |
| Goldberg, Lowenstein & Weatherwax LLP 1925 Century Park East Suite 2120 Los Angeles, CA 90067 | | | <table border="1"> <tr> <th>ART UNIT</th> <th>PAPER NUMBER</th> </tr> <tr> <td>3992</td> <td></td> </tr> </table> | | ART UNIT | PAPER NUMBER | 3992 | |
| ART UNIT | PAPER NUMBER | | | | | | | |
| 3992 | | | | | | | | |
| | | | <table border="1"> <tr> <th>MAIL DATE</th> <th>DELIVERY MODE</th> </tr> <tr> <td>11/20/2012</td> <td>PAPER</td> </tr> </table> | | MAIL DATE | DELIVERY MODE | 11/20/2012 | PAPER |
| MAIL DATE | DELIVERY MODE | | | | | | | |
| 11/20/2012 | PAPER | | | | | | | |

Please find below and/or attached an Office communication concerning this application or proceeding.

The time period for reply, if any, is set in the attached communication.



UNITED STATES PATENT AND TRADEMARK OFFICE

Commissioner for Patents
United States Patents and Trademark Office
P.O.Box 1450
Alexandria, VA 22313-1450
www.uspto.gov

THIRD PARTY REQUESTER'S CORRESPONDENCE ADDRESS
BRYAN CAVE LLP
1290 AVENUE OF THE AMERICAS
NEW YORK, NY 10104

Date:

EX PARTE REEXAMINATION COMMUNICATION TRANSMITTAL FORM

REEXAMINATION CONTROL NO. : 90012304
PATENT NO. : 7469381
ART UNIT : 3992

Enclosed is a copy of the latest communication from the United States Patent and Trademark Office in the above identified ex parte reexamination proceeding (37 CFR 1.550(f)).

Where this copy is supplied after the reply by requester, 37 CFR 1.535, or the time for filing a reply has passed, no submission on behalf of the ex parte reexamination requester will be acknowledged or considered (37 CFR 1.550(g)).

| | |
|--|-------------------------|
| Decision on Petition for Extension of Time in Reexamination | Control No.: 90/012,304 |
|--|-------------------------|

1. THIS IS A DECISION ON THE PETITION FILED 11/19/12.

2. THIS DECISION IS ISSUED PURSUANT TO:

A. 37 CFR 1.550(c) – The time for taking any action by a patent owner in an *ex parte* reexamination proceeding will be extended only for sufficient cause and for a reasonable time specified.

B. 37 CFR 1.956 – The time for taking any action by a patent owner in an *inter partes* reexamination proceeding will be extended only for sufficient cause and for a reasonable time specified.
The petition is before the Central Reexamination Unit for consideration.

3. FORMAL MATTERS

Patent owner requests that the period for responding to the Office action dated 10/15/12 which sets a two (2) month period for filing a response to the Office action, be extended by one (1) months.

A. Petition fee per 37 CFR §1.17(g):

i. Petition includes authorization to debit a deposit account.

ii. Petition includes authorization to charge a credit card account.

iii. Other: _____

B. Proper certificate of service was provided. (Not required in reexamination where patent owner is requester.)

C. Petition was timely filed.

D. Petition properly signed.

4. DECISION (See MPEP 2265 and 2665)

A. Granted or Granted-in-part, because petitioner provided a factual accounting that established sufficient cause. (See 37 CFR 1.550(c) and 37 CFR 1.956).

B. Other/comment:

C. Dismissed because:

i. Formal matters (See unchecked box(es) (A, B, C and/or D) in section 4 above).

ii. Petitioner failed to provide a factual accounting of reasonably diligent behavior by all those responsible for preparing a response to the outstanding Office action within the statutory time period.

iii. Petitioner failed to explain why, in spite of the action taken thus far, the requested additional time is needed.

iv. The statements provided fail to establish sufficient cause to warrant extension of the time for taking action (See attached).

v. The petition is moot.

vi. Other/comment:.

5. CONCLUSION

Telephone inquiries with regard to this decision should be directed to Alexander Kosowski at 571-272-3744.

/Alexander Kosowski/
[Signature]

SPE, AU 3992 Central Reexamination Unit
(Title)

IN THE UNITED STATES PATENT AND TRADEMARK OFFICE

| | | |
|--|-------------------|--------------------------|
| In the Reexamination of USP 7,469,381) | Confirmation No.: | 4807 |
| to Ording) | | |
| Control No.: 90/012,304) | Group Art Unit: | 3992 |
| Reexam Request Filed: 5/23/2012) | Examiner: | Bonshock, Dennis |
| For: LIST SCROLLING AND) | Attorney Docket: | |
| DOCUMENT TRANSLATION,) | | P4304USREX2/120730-002US |
| SCALING, AND ROTATION ON A) | | |
| TOUCH-SCREEN DISPLAY) | | |

Mail Stop Ex Parte Reexam
 Central Reexamination Unit
 Commissioner for Patents
 United States Patent & Trademark Office
 P.O. Box 1450
 Alexandria, VA 22313-1450

Declaration Of Bas Ording Under 37 CFR § 1.131

I, Bas Ording, declare as follows:

1. I am the sole named inventor of issued U.S. Patent No. 7,469,381 B2 (“the ‘381 patent”). I have prepared this declaration at the request of counsel in the reexamination of the ‘381 patent, to describe facts about my work at Apple Inc. (“Apple”) that led to my inventions described in the patent.
2. Since 1998, I have been an employee in Apple’s Human Interface group in Cupertino, California. My job title is User Interface Designer.
3. Over the course of several years until the iPhone was released to the public in 2007, I worked continuously and diligently with numerous other Apple employees in the Human Interface group, including my supervisor Greg Christie, Scott Forstall, and Apple

CEO Steve Jobs, on the confidential development of the user interface (“UI”) for a touch screen phone prototype that eventually became the iPhone.

4. My role in this work included working on user interface improvements that would facilitate the use of such a device to view content on the touch screen without operating a mouse or buttons (such as keys on a keyboard) to navigate.

5. During this period, the touch screen user interface improvements I was developing and testing included translating content on the touch screen by touching it with a finger placed on the screen and then moving the finger. The device would detect the finger and its movement, and respond by translating the document on the screen to follow the movement of the finger.

6. Since before I joined Apple, I have used an application known as Director to write code for UI operations that allows a user to interact with a computer, for example with a touch screen display, by, for example, swiping a finger on the touch screen display to translate a document on the touch screen. Director uses a form of C++ code called Lingo. Director allows me to very quickly implement code I have written and determine whether the UI works as I intended. I used Director to develop, demonstrate and successfully test the UI features that I discuss in this declaration on a computer with an attached touch screen display in my office at Apple. My demonstration and testing of the features of the UI this way was consistent with the way such user interfaces are normally demonstrated and tested at Apple.

7. When I was developing and testing code using Director on this computer throughout this period before May 15, 2005, I often discussed the UI tests with, and demonstrated them to, Mr. Christie (whose office was near mine), Mr. Jobs, or both.

8. In particular, for a period ending about May 15, 2005, I worked continuously and diligently on designing, writing code for, and successfully testing UI software that would implement a fully functioning scrollable list of contacts, such as in an address book, on a small phone-sized touch screen display on or attached to a computer.

9. Mr. Jobs had told me, Mr. Christie, and others that he wanted us to work on developing a multifunction touch screen mobile phone, with a smaller touch screen than I had been using in some earlier touch screen UI testing.

10. Specifically, Mr. Jobs asked me to program user interface features demonstrating how information for a list of persons – in this example a contact list or address book – could be displayed and navigated on this smaller touch screen, so that a user could, for example, select a person's name on the list and see additional information such as contact information.

11. Beginning then and until at least about May 15, 2005, I worked diligently on a day to day basis programming this functionality and testing it using Director.

12. In early tests, the list appeared on the display as a list of names running vertically down the screen separated by a regular amount of distance, with the background alternating between two shades changing halfway between each pair of names, so that each name appeared in a rectangular background having one of two shades.

13. Also in early tests, when the user scrolled to the top name or bottom name of this list, the UI was programmed so the list on the touch screen would stop scrolling when an end of the list reached the display window. In other words, scrolling the list did not display any space beyond the end of the list, because the scrolling would simply stop when the end of the list reached the display, and go no farther.

14. Sometime before May 15, 2005 while I was working on this scrolling list UI, I demonstrated to Mr. Christie, in person, how the contact list would scroll, including how it would simply stop, for example, if one end of the list was reached when scrolling this list of names on the touch screen.

15. While working on these scripts and tests, I repeatedly encountered a situation where I would attempt to scroll my displayed list by swiping my finger up or down the touch screen over the list and the list would not move in response to my gesture. When

this occurred, I wondered if my touch screen device was freezing because of an error, as would happen from time to time in the process of testing the new code I was writing.

16. What I often discovered was that, in fact, the code was still running, and that I had scrolled all the way to one end of the list without realizing it. The device was simply not letting me scroll past the end of the list. More precisely, for example, if the top of the list was fully visible, the device would not allow me, by moving my finger on the screen downward, to scroll the list any further downward, and thus would simply not respond to my downward finger movement. The analogous situation would occur at the bottom of the list.

17. I worked on ideas to solve this problem. Before about May 15, 2005, I thought of some ideas that, when I programmed and tested them using Director, worked to my satisfaction to solve the problem.

18. When I implemented, programmed, and successfully tested these ideas on the UI for my scrollable contact list, the result was that if a finger touch gesture was used to scroll the contact list, and an end of the list was reached while scrolling with the finger touch gesture, the list would move in the display much like it would have if it had been a physical object elastically connected to the edge of the display window. This functionality included the following steps:

- a. displaying a portion of the contact list,
- b. scrolling the contact list in response to finger movements to display another portion of the list,
- c. if the list was scrolled so the top or bottom of the list was reached while scrolling in response to finger movements, displaying an area beyond the edge of the list together with a smaller portion of the list, and
- d. when the finger was lifted off the screen, scrolling in the opposite direction until the area beyond the list was no longer displayed.

Like many others at Apple, I sometimes refer to UI functionality like this as “rubberbanding” for convenience, because this behavior can give the impression that a

scrolled list, for example, or translated web page, for another example, is connected to the edge of the display by a rubber band. The “rubberbanding” features I developed and successfully tested included damping or slowing movement in both directions, which helped strengthen the impression of elastic attachment.

19. During my programming and testing of the “rubberbanding” UI features I had conceived, I developed an early version of the code and personally used this code on Director to demonstrate to Mr. Jobs and Mr. Christie on my computer having a touch screen display, prior to about May 15, 2005, how the UI “rubberbanding” features I had developed worked. I let them scroll the list themselves so they could use the functionality and test how it worked. Messrs. Jobs and Christie tested my UI and saw for themselves how well the “rubberbanding” features worked for the user. They both expressed to me their approval of how these features worked.

20. Shortly after this demonstration, but before about May 15, 2005, Mr. Jobs told me that he wanted to have the phone touch screen device under development demonstrated at a confidential meeting of select Apple employees, and that it was important that my “rubberbanding” features be demonstrated in the UI at this demo. The demo was scheduled for about May 15, 2005.

21. Because of the importance of including this functionality in this upcoming demonstration (which people on the development team sometimes referred to as the “Big Demo”), I continued, for many days leading up to the demo, to refine and test my programming of the UI for the scrollable contact list using Director on the touch screen attached to my office computer.

22. On May 14, 2005, on the eve of the Big Demo, I finished my code revisions for the scrollable contact list UI, and ran them using Director to successfully demonstrate on my computer touch screen that the scrollable contact list was fully functional. Using Director, I tested the UI on the computer touch screen display to determine, for example, if the touch screen device would display the contact list; detect movement of the user’s finger, respond to movements of the user’s finger; display an area beyond the

end of the list if an end of the list was reached while responding to movements of the user's finger; and, upon liftoff of the user's finger, scroll the contact list in the opposite direction until the displayed area beyond the end of the list was no longer displayed. On the evening of May 14, 2005, after finishing my revisions, I successfully tested and demonstrated these features in front of Mr. Christie, who was actively helping me with the testing of the scrollable contact list, and he saw and voice approval of how they worked.

23. Here is an example of how the code I wrote and successfully tested in the presence of Mr. Christie on May 14, 2005 for use in the Big Demo worked.

24. The code I wrote defined a displayable list of items that included displayable images of names in a contact list or address book. The list appeared on the touch screen display as an alphabetical, vertical list of names displayed in adjoining white rectangular areas separated by horizontal lines. The contact list information came from a data file that included people's names, which appeared in alphabetical order, one name per rectangle. I defined the total vertical length of this list as equal to the distance from the top of the top margin of the list to the bottom of the bottom margin of the list, thus including the height of all the name items in between.

25. For example, I, as a user, started with the touch screen display window displaying a first portion of the list. When I, as the user, moved my finger touching the display window downward, the list moved downward in the touch screen display a distance and at a speed that depended on how far and how fast I moved my finger, and a different portion of the list was displayed. For example, I might move my finger slowly one inch down the display window, and the list would scroll equally slowly one inch down the display window, to reveal more content at the top of the display window as other content left the display at the bottom of the display window.

26. If the end of the list reached the display window while I used my finger to scroll downward in this manner, the list continued to scroll downward, displaying an area beyond the top margin of the list, and a third portion of the list that was smaller than the

first portion mentioned above. The area beyond the list appeared as a different color than the white background of the names on the list.

27. If I, as a user, then lifted my finger off the touch screen, my UI program detected the liftoff. In response to this liftoff, the list now moved upward in the display until the end of the list was flush with the top edge of the display window and then stopped there, so that the area beyond the end of the list was no longer displayed and a fourth portion of the list different from the first portion mentioned above, was displayed.

28. Analogous operations would occur at the other end of the list, with the directions being reversed.

29. In these operations, once the area beyond the list was displayed on the screen, the list would no longer scroll down as fast and as far as my finger moved on the display window, but would begin to go more slowly than my finger, appearing to meet some resistance to continued movement. When I lifted my finger, and the list scrolled back in the opposite direction in response, it scrolled in a damped manner, coming to a stop just at the point where the area beyond the edge could no longer be seen and the edge of the list was flush with the edge of the viewable area. This behavior, as noted above, gave the visual impression that the edge of the list was elastically attached to the edge of the display window.

30. Once I had used Director to run this code on my touch screen computer to demonstrate to my satisfaction that these rubberbanding UI features worked on May 14, 2005, and demonstrated it on the same day to Mr. Christie, in person, to his approval, the computer was prepared for use the next day, using Director to run the same code, to demonstrate the scrollable contact list at the Big Demo.

31. I was informed by Mr. Christie, and also by others, that the planned demonstration and testing of my scrollable contact list, including its UI “rubberbanding” features, had successfully been carried out at the “Big Demo” in front of a select group of Apple

employees, and that the demonstration of these features was well received by the audience.

32. For example, **Exhibit A** is an email dated May 15, 2005 from Mr. Christie to Scott Forstall of Apple, on which I was copied and which I received, about the demo that day. Under the heading "address book," Mr. Christie wrote in bold, italicized emphasis: "***all contacts is a fully functional scrolling list demo***".

address book

- the first time address book is opened you can't do anything for a 1/2 or 1 second while it loads
- any of the groups will take you to all contacts
- ***all contacts is a fully functional scrolling list demo***
- can go back to groups
- index letters work
- tap name to get card
- tap phone number to call
- back & forth between groups, all contacts, and single entry

I understand, and at the time understood, this statement by Mr. Christie to refer to the important demonstration of the fully functional rubberbanding contact list using my Director code. This email by Mr. Christie indicates that he had witnessed the demonstration and successful testing of the features of the rubberbanding scrollable contact list I had programmed and implemented.

33. After the Big demo, I and other team members continued confidentially developing the touch screen phone device, which was to include the rubberbanding UI features successfully tested at the Big Demo. By 2007, the touch screen phone had become the iPhone. I currently have an iPhone 5, and it has still has rubberbanding.

34. I have attached two examples, from two different times, of the UI code I wrote and tested in Director for the scrollable contact list discussed above. As discussed below, these electronic files include dated electronic file information identifying me as having created them and last modified them prior to May 15, 2005.

35. **Exhibit B** is a printout of the early version of my code for the scrollable contact list UI that I mentioned in paragraph 19 above. These scripts are from a Director file called 'tos + scroll10lk5 select.dir', which is a code file that I recently retrieved for the purpose of preparing this declaration from storage on the hard disk drive memory of my office computer, and which has been stored on hard disk in my office since I last modified it on a date before May 15, 2005. As I have explained, I personally wrote this code when I was working on developing my rubberbanding UI for the scrollable contact list. It includes scripts that, when executed using Director, serve as instructions for my touch screen computer to perform steps of a rubberbanding UI for a scrollable contact list.

36. **Exhibit C** is a printout of the desktop icon on my office computer desktop for the 'tos + scroll10lk5 select.dir' file, with a last modified date, redacted here, confirming that the file was last modified before May 15, 2005. **Exhibit D** is a printout of the file properties information for the 'tos + scroll10lk5 select.dir' file on my office computer as retrieved from the "Property Inspector" dialog of the copy of the Director application resident on my office computer, showing that I am the author of the .dir file. **Exhibit E** is a printout of the list of computer files found on the hard disk drive memory of my office computer in the file folder 'tos + scroll', showing that 'tos + scroll10lk5 select.dir' is in this folder on my computer, with a last-modified date, redacted here, that is the same date as that shown in **Exhibit C**.

37. **Exhibit F** is a printout of the scrollable contact list UI code file that, as I explained in paragraphs 30-31 above, Mr. Jobs actually used in his May 15, 2005 "Big Demo" to demonstrate the fully functional scrollable contact list. The scripts are in a Director file called 'addressBook 15q.dir', which I recently retrieved for the purpose of preparing this declaration from storage on the hard disk drive memory of my office computer, and which has been stored on hard disk in my office since I last modified it on May 14, 2005. As I have explained, this code was written by me and includes scripts that, when executed using Director, served as instructions for my touch screen computer to perform steps of a rubberbanding UI for a scrollable contact list as described in paragraphs 23-28 above.

38. **Exhibit G** is a printout of the desktop icon on my office computer desktop for the "addressBook 15q.dir" file, with a date confirming that the file was last modified on May 14, 2005 at 10:13 PM. **Exhibit H** is a printout of the file properties information for the 'addressBook 15q.dir' file on my office computer as retrieved from the "Property Inspector" dialog of the copy of the Director application resident on my office computer, showing that I am the author of the file. **Exhibit I** is a printout of the list of computer files found on the hard disk drive memory of a file folder of my office computer, showing that 'addressBook 15q.dir' is in this folder on my computer with the same last-modified date as **Exhibit G**.

39. I note that, like many people in Human Interface and elsewhere at Apple, most of my work and records are created on computers rather than paper. Moreover, partly because I am programming new code and devices, much of my work is done in local copies on computers in my office, rather than on remotely stored files backed up to companywide servers. These facts have been true of my work since before 2005.

40. Thus, by May 15, 2005, I conceived of and successfully tested the features of the "rubberbanding" invention, set forth in my scripts in 'addressBook 15q.dir' (see **Exhibit F**). The stored properties of the 'addressBook 15q.dir' file confirm that I am its author and last modified it on May 14, 2005 (see **Exhibits G-I**). Steve Jobs ran the scripts in 'addressBook 15q.dir' on May 15, 2005 to successfully test and demonstrate the rubberbanding features in the code, as witnessed by Mr. Christie and many other select Apple employees (see **Exhibit A**).

41. In preparing this declaration, I discussed the code in **Exhibits B** and **F** with counsel, and I provide the following additional information about Director and the code in 'addressBook 15q.dir'.

42. The 'addressBook 15q.dir' file contains numerous scripts that run on Director.

43. For running the "Big Demo," a dataset of contact names called "name list" was available to be accessed by the code in 'addressBook 15q.dir' in the "new" function and other functions it calls.

44. Where the 'addressBook 15q.dir' scripts define numerical lengths or positions, the numbers given represent screen pixels.

45. In the List Object script in 'addressBook 15q.dir', the "draw" function was called several times per second by "draw gListsObject" to redraw the object in the display.

46. When 'addressBook 15q.dir' was run on Director, the system called "TmouseDrag" several times per second to detect for movement to determine whether to perform a scroll operation. This was a function usually handled by a mouse, which Director would borrow for the touch screen.

47. When 'addressBook 15q.dir' was run on Director, the system called the "exitFrame" function several times per second.

48. I hereby declare that all statements made herein of my own knowledge are true and that all statements made on information and belief are believed to be true; and further that these statements were made with the knowledge that willful false statements and the like so made are punishable by fine or imprisonment, or both, under Section 1001 of the Title 18 of the United States Code and that such willful false statements may jeopardize the validity of the patent under reexamination.

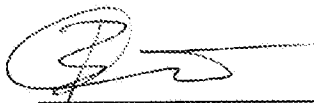

Bas Ording

Date: 15 JAN 2013

Application No. 90/012,304

Declaration Of Bas Ording Under 37 CFR § 1.131 (Jan. 15, 2013)

Exhibit

A

Subject: BIG demo notes

Date: Sun, 15 May 2005 02:35:56 -0700

From: "Greg Christie" <christie@apple.com>

To: "Scott Forstall" <forstall@apple.com>

Cc: "Bas Ording" <bas@apple.com>, "patrick coffman" <pcoffman@apple.com>

Message-ID: <56BC1839-935E-4A5B-800B-D40900165899@apple.com>

menu

- menu alternates where you are to menu -- use this to get out of anything

incoming call

- secret button is lower left corner for incoming call
- press and hold, screen blacks out
- tap the screen for an incoming call
- slide to unlock
- then accept or decline
- after call, screen re-locks
- press menu to go back to everything else

keypad

- clear works to erase a number
- call works
- when in a call
- tap to toggle hold
- tap to toggle speaker
- tap to end call

address book

- the first time address book is opened you can't do anything for a 1/2 or 1 second while it loads
- any of the groups will take you to all contacts
- *all contacts is a fully functional scrolling list demo*
- can go back to groups
- index letters work
- tap name to get card
- tap phone number to call
- back & forth between groups, all contacts, and single entry

speed dial

- any tap on the list calls john appleseed
- end call, go back to speed dial list
- tap on right side to show john appleseed's card
- can go back to speed dial
- any press in bottom bar does an "add"
- pick john appleseed, pick mobile number
- second tap in bottom bar puts in edit mode
- tap minus to remove last john appleseed; tap remove; then done

ipod

- opens in top level (iPod)
- the first time iPod is opened you can't do anything for a second or two while it loads.
- tap playlists, go back
- tap artists -> beatles -> Sgt. Pepper->Fixing a hole (back works in all of this)
- tap albums, go back
- *songs is a fully functional scrolling demo, index letters, etc..*
 - can play any song, go back to songs, play another, etc*
- Now playing display shows album art, progress bar, etc...

now playing only works in songs and in iPod
volume works everywhere
play/pause work everywhere

mail

- flip between split view and column view
- tap to get message from john appleseed
- tap name john appleseed to see his card, and go back
- tap info button to see addressees
- tap info button again to collapse addresses
- "file message" works. tap john appleseed in list again to get back to message
- delete works; tap john appleseed to go back to message
- "reply" works; hit any of the reply buttons brings up the reply; press info button, add an addressee; send this message or delete it
- new message works; press plus to add john appleseed; choose an email address; send this message or cancel it

sms

- tap person in the list to look at the sms message from john appleseed
- tap keyboard to add response
- tap keyboard to send it
- tap keyboard again to see reply
- at any time "delete" or go back to list
- create new sms message; tap plus button; tap addressee; pick phone number; tap keyboard to type; tap keyboard again to send
- go back to menu

ical

- just shows calendar

voicemail

- shows call in progress to voicemail server

web/safari

- shows a webpage
- tap to zoom
- tap for text field focus & show keyboard
- tap to dismiss keyboard
- tap zooms out

- demo loops from there

weather

- tap right edge to cycle right
- tap left edge to cycle left

stocks

- tap on any stock to see a chart
- drag through the list

yellow pages

- just shows yellow pages

calculator

- just shows calculator

unit converter

- just shows unit converter

translator

- just shows translator

tile puzzle

- just shows tile puzzle

slide show

- tap shows the index view
- tap any picture to show that picture; this will start the slide show
- tap to bring up OSD controls
- next/next or previous/previous or play/pause or go back to index
- OSD fades out after a few seconds
- as long as it is in play it will cross fade between slides

flight tracker

- just shows flight tracker

----- end message -----

Application No. 90/012,304

Declaration Of Bas Ording Under 37 CFR § 1.131 (Jan. 15, 2013)

Exhibit B

display object (Internal)

```
--global scrollPos, scrollSpeed, fingerRatio
property controlledByList

--property startYpos, lastYpos, startScroll, lastSpeed
--property lastLineSelect

property screenContext, nameBitmaps
property itemHeight, nameCount, viewHeight, listLength
property topSpace, bottomSpace
property intScroll, fineScroll, scrollSpeed, speedList
property scrollAtStart, touchPosAtStart, startTouchTime
property preSelectItem, selectedItem
property lastTouchPos, lastTouchTime, hasScrolled
property lastUpdateTime
property scrubbSelection, dontSelect

on new me
  controlledByList = []

  -----

  screenContext = member("screen buffer").image

  generateNameBitmaps me

  itemHeight = 21
  viewHeight = screenContext.height
  topSpace = 50
  bottomSpace = 50
  listLength = topSpace + (itemHeight * nameCount) + bottomSpace

  fineScroll = 0.0
  intScroll = integer(fineScroll)
  scrollSpeed = 0.0
  speedList = []

  lastUpdateTime = the milliseconds

  preSelectItem = 0
  selectedItem = 0

  drawList me

  return me
end
```

on generateNameBitmaps me

```

nameBitmaps = []
nameList    = member("name list").text
nameCount   = the number of lines of nameList

member("name item").width    = 208
member("name item").fontSize = 13

repeat with n = 1 to nameCount
  member("name item").text = line n of nameList
  add nameBitmaps, duplicate(member("name item").image)
end repeat

```

end

on drawList me

```
fill screenContext, screenContext.rect, rgb(255, 255, 255)
```

```
intScroll = integer(fineScroll)
```

```
yy = 50 - intScroll
```

```

repeat with n = 1 to nameCount
  if (yy + n * itemHeight > 0) then
    startN = n
    exit repeat
  end if
end repeat

```

```

endN = nameCount
repeat with n = startN + 1 to nameCount
  if (yy + (n - 1) * itemHeight >= viewHeight) then
    endN = n
    exit repeat
  end if
end repeat

```

```
g = integer(255 * 0.9)
```

```
repeat with n = startN to endN
```

```

y      = yy + (n - 1) * itemHeight
nameTag = nameBitmaps[n]
r      = nameTag.rect
cof    = (itemHeight - r.height) / 2 + 2

```

```
--draw screenContext, rect(0, y + itemheight, 193, y + itemheight + 1), rgb(g, g, g)
```

```
if (n mod 2 = 1) then
  fill screenContext, rect(0, y, 208, y + itemheight), rgb(g, g, g)
  --draw screenContext, rect(0, y + itemheight, 193, y + itemheight + 1), rgb(g, g, g)
end if
```

```
if (n = preSelectItem) then
  fill screenContext, rect(0, y, 208, y + itemheight), rgb(191, 207, 241)
end if
```

```
copyPixels screenContext, nameTag, r.offset(16, y + cof), r, [#bgcolor: 255]
```

```
if (n = selectedItem) then
  fill screenContext, rect(0, y, 208, y + itemheight), rgb(0, 64, 200)

  copyPixels screenContext, nameTag, r.offset(16, y + cof), r, [#bgcolor: 0]
end if
```

```
end repeat
```

```
end
```

```
on update me
```

```
  currentTime = the milliseconds
```

```
if (scrollSpeed <> 0.0) then
```

```
  dt = currentTime - lastUpdateTime
```

```
  if (dt > 0) then
```

```
    repeat with n = 1 to dt
```

```
      scrollSpeed = scrollSpeed * 0.998
```

```
      fineScroll = fineScroll - scrollSpeed
```

```
      -- if (fineScroll < 0) then
```

```
        -- fineScroll = 0
```

```
        -- scrollSpeed = 0.0
```

```
        -- end if
```

```
      -- if (fineScroll > listLength - viewHeight) then
```

```
        -- fineScroll = listLength - viewHeight
```

```
        -- scrollSpeed = 0.0
```

```
        -- end if
```

```
    end repeat
```

```
  end if
```

```
    drawList me
end if
--else

if (fineScroll < 0          ) then
    fineScroll = (7.0 * fineScroll + 0) / (8.0)
    scrollSpeed = 0.5 * scrollSpeed
    drawList me
end if
if (fineScroll > listLength - viewHeight) then
    fineScroll = (7.0 * fineScroll + (listLength - viewHeight)) / (8.0)
    scrollSpeed = 0.5 * scrollSpeed
    drawList me
end if

if (abs(scrollSpeed) < 0.05) then scrollSpeed = 0.0

--end if

lastUpdateTime = currentUpdateTime
end
```

```
on startPress me, pos

    scrollAtStart    = intScroll
    touchPosAtStart = pos

    lastTouchPos = pos

    hasScrolled = FALSE

    startTouchTime = the milliseconds
    lastTouchTime  = the milliseconds

    preSelectItem = 0

    scrubbSelection = FALSE

    vList = [scrollSpeed]

    dontSelect = ( abs(scrollSpeed) > 0.05 )
end
```

```
on movePressed me, pos
```



```
currentTouchTime = the milliseconds

if (scrubbSelection) then

    dy = integer(lastTouchPos.locV) - sprite(10).top + intScroll - topSpace
    preSelectItem = dy / itemHeight + 1
    drawList me

    scrollSpeed = 0.0

    jogg = pos.locV - touchPosAtStart.locV
    jogDD = 40

    if (jogg > 0) then

        if (jogg > jogDD) then
            jogg = jogg - jogDD
            scrollSpeed = -jogg / 100.0
        end if

    else

        if (jogg < -jogDD) then
            jogg = jogg + jogDD
            scrollSpeed = -jogg / 100.0
        end if

    end if

else -- check to start scroll of scrubb

    currentFineScroll = fineScroll

    if (not hasScrolled) then

        scrollSpeed = 0.0

        if ( abs(pos.locV - touchPosAtStart.locV) > 10 ) then
            hasScrolled = TRUE

            touchPosAtStart = lastTouchPos

            preSelectItem = 0
        else
```

```

if (dontSelect) then
    --beep
else
    if (currentTime - startTouchTime > 300) then
        dy = integer(lastTouchPos.locV) - sprite(10).top + intScroll - topSpace
        preSelectedItem = dy / itemHeight + 1
        drawList me
        scrubbSelection = TRUE
    end if
end if
end if
end if

-- should calculate total travel including H direction
if (hasScrolled) then
    newScroll = scrollAtStart - (pos.locV - touchPosAtStart.locV) * 1.0
    if (newScroll < 0) then newScroll = (1.0 * newScroll + 0) / (2.0)
    if (newScroll > listLength - viewHeight) then newScroll = (1.0 * newScroll +
(listLength - viewHeight)) / (2.0)

    dt = currentTime - lastTouchTime
    if (dt > 0) then
        repeat with k = 1 to dt
            fineScroll = (20.0 * fineScroll + 1.0 * newScroll) / (20.0 + 1.0)
        end repeat

        newSpeed = 1.0 * (currentFineScroll - fineScroll) / dt
        add speedList, newSpeed

        c = count(speedList)
        if (c > 5) then deleteAt speedList, 1
    end if

    scrollSpeed = 0.0

    drawList me
end if
end if

```

```
    lastTouchPos = pos
    lastTouchTime = currentTime
end
```

```
on releaseFinger me
```

```
    if (not hasScrolled) then
```

```
        if (dontSelect) then
```

```
            selectedItem = 0
            preSelectedItem = 0
```

```
            drawList me
```

```
        else
```

```
            -- YES: selection
```

```
            dontSelect = FALSE
            scrollSpeed = 0.0
```

```
            if (the milliseconds - startTouchTime > 50) then -- really select
```

```
                dy = integer(lastTouchPos.locV) - sprite(10).top + intScroll - topSpace
                selectedItem = dy / itemHeight + 1
                preSelectedItem = 0
```

```
                if (selectedItem < 1 or selectedItem > count(nameBitmaps)) then selectedItem = 0
```

```
                drawList me
```

```
                if (selectedItem <> 0) then -- tapped on a name
```

```
                    global contactObject
                    setNameTagImg contactObject, duplicate(nameBitmaps[selectedItem])
```

```
                    showContact me
```

```
                end if
```

```
            end if
```

```
        end if
```

```
    else
```

```
        c = count(speedList)
```

```
if (c > 0) then

  -- speed
  avSpeed = 0.0
  repeat with n = 1 to c
    avSpeed = avSpeed + speedList[n]
  end repeat
  avSpeed = avSpeed / c

  -- acceleration
  if (c > 1) then
    --alist = []
    avAcc = 0
    repeat with n = 2 to c
      acc = speedList[n] - speedList[n - 1]
      avAcc = avAcc + acc
      --add alist, acc
    end repeat
    avAcc = avAcc / c

    --avAcc = vList[c] - vList[c - 1]

    --put avAcc

    avSpeed = avSpeed + 1.0 * avAcc
  end if

  --scrollSpeed = lastSpeed
  scrollSpeed = avSpeed
end if

dontSelect = TRUE

end if

end

on showContact me

global buttonObject

slideOpen buttonObject

-- global displayObject, widgetObject, buttonObject, contactObject
--
-- --if (slideMode = #open) then
-- -- fromPrc = 0
-- -- toPrc = 208
-- -- dur = 250.0
-- -- buttonObject.slideMode = #closed
```

```

-- --     else
-- fromPrc = 208
-- toPrc   = 0
-- dur     = 250.0
-- buttonObject.slideMode = #open
-- --     end if
--
--
-- st = the milliseconds - 16
-- repeat while (TRUE)
--   t = the milliseconds - st
--
--   if (t > 0) then
--     if (t < dur) then
--       progress = t / dur
--       ease     = 0.5 - 0.5 * cos(PI * progress)
--       prc      = fromPrc + (toPrc - fromPrc) * ease
--     else
--       progress = 1.0
--       prc      = toPrc
--     end if
--
--     sprite(10).loch = 900 + prc
--     sprite(11).loch = 900 + prc - 208
--
--     update displayObject
--     update contactObject --widgetObject
--
--     updatestage
--
--     if (progress = 1) then exit repeat
--   end if
--
-- end repeat

```

end

```

-----

on tryUsing me, byWhom
  if (count(controlledByList) = 0) then
    add controlledByList, byWhom
  
```

```
    return me
  else
    return 0
  end if
end
```

```
on stopUsing me, byWhom
  p = getPos(controlledByList, byWhom)
  if (p <> 0) then deleteAt controlledByList, p
end
```

Application No. 90/012,304

Declaration Of Bas Ordning Under 37 CFR § 1.131 (Jan. 15, 2013)

Exhibit C

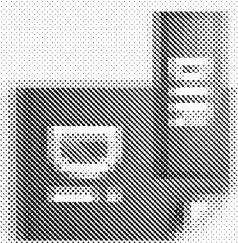

tos + scroll101k5 sel... 2.2 MB
Modified: [REDACTED] PM

Application No. 90/012,304

Declaration Of Bas Ording Under 37 CFR § 1.131 (Jan. 15, 2013)

Exhibit D

Property Inspector

Macintosh HD:Users:basording:Desktop:tos + scroll10lk5 select.dir

Di

Guides Movie Display Template

Stage Size: 1024 X 768

Channels: 128

Color: #000000

Palette: System - Mac

RGB Index

Enable Edit Shortcuts

Preferred 3D Renderer: Auto

Active 3D Renderer: #openGL

About:

Copyright:

Created By: Bas Ording - Apple Computer, Inc.

Modified By: Apple Apple - Apple

Font Map: Save Load

Application No. 90/012,304

Declaration Of Bas Ordng Under 37 CFR § 1.131 (Jan. 15, 2013)

Exhibit E

| Name | Date Modified | Date Created | Size |
|-----------------------------|---------------|--------------|--------|
| tos + scro/110.dir | 6:09 PM | 6:09 PM | 973 KB |
| tos + scro/110k.dir | 5:10 PM | 5:10 PM | 1.3 MB |
| tos + scro/110k2.dir | 5:26 PM | 5:26 PM | 1.5 MB |
| tos + scro/110k3.dir | 5:31 PM | 5:31 PM | 1.4 MB |
| tos + scro/110k4.dir | 7:21 PM | 7:21 PM | 1.5 MB |
| tos + scro/110k5.select.dir | 3:07 PM | 3:07 PM | 2.2 MB |
| tos + scro/110k5.dir | 8:13 PM | 8:13 PM | 1.8 MB |
| tos + scro/110k5widg.dir | 8:57 PM | 8:57 PM | 2 MB |

Application No. 90/012,304

Declaration Of Bas Ording Under 37 CFR § 1.131 (Jan. 15, 2013)

Exhibit F

1 (Internal)

```
global gListObject, giveMeAGo
```

```
on startMovie
```

```
  if ( not voidP(gListObject) ) then
    doSetUp
  else
    giveMeAGo = TRUE
  end if
```

```
end
```

```
on keepGoing
```

```
  doSetUp
```

```
end
```

```
on doSetUp
```

```
  init
  startScrollView
```

```
  go "list"
```

```
end
```

```
--on prepareMovie
```

```
--
```

```
--  init
```

```
--
```

```
--  the floatPrecision = 8
```

```
--
```

```
--  startScrollView
```

```
--
```

```
--end
```

```
on slideGroupsToList
```

```
    go (label("groups") + 1)
end

on slideListToGroups
    go (label("list") - 1)
end

on slideListToCard
    go (label("list") + 1)
end

on slideCardToList
    go (label("card") - 1)
end

on fixList

    member("screen buffer 2").image = duplicate(member("screen buffer").image)
    member("screen buffer 2").regPoint = point(0, 0)

    gListObject.selectedID = 0
    draw gListObject

end

on startScrollView

    if (voidP(gListObject)) then gListObject = new(script("list object"), member("screen
buffer").image)

        setFineScroll gListObject, 0

        draw gListObject

end

on buildCard

    orgCardMem = member("card orig")
    cardMem     = member("card")

    cardMem.image     = duplicate(orgCardMem.image)
    cardMem.regPoint = point(0, 0)
```

list object (Internal)

property pDrawBuffer, pViewWidth, pViewHeight
 property listLength, scrollPos, fineScrollPos

property topSpace, bottomSpace
 property pNameXstart, pNameXend
 property pLastNameList, pFirstNameList, pNameCount
 property pItemHeight, pMaxNameWidth, pElypsisWidth
 property pLastNameStrings, pNameStrings, pNameBitmaps, pLastNameOffsets
 property pCapImgList, pAltCapImgList
 property pBlueBarImg, pBlueBadgeImg
 property pCurrentStrip, pLastNameStrip, pFirstNameStrip

property pIndexImg, hasIndexStrip

property selectedID

on new me, bufferRef

pDrawBuffer = bufferRef

pViewWidth = pDrawBuffer.width
 pViewHeight = pDrawBuffer.height

topSpace = 50
 bottomSpace = 50

pItemHeight = 31 --32

pNameXstart = 12 --+ 18
 pNameXend = pViewWidth - 8 - 8 - 3
 pMaxNameWidth = pNameXend - pNameXstart

fineScrollPos = 0.0
 scrollPos = integer(fineScrollPos)

pLastNameList = member("name list").text
 pFirstNameList = member("first name list").text
 pNameCount = pLastNameList.lines.count

selectedID = 0

--generateNameBitmaps me
 generateBoldNameBitmaps me

generateIndexLetters me

generateLastnameStrip me

```
pCurrentStrip = pLastNameStrip

listLength = topSpace + pCurrentStrip.myLength + bottomSpace

-- generateFirstnameStrip me
-- alternateColors pFirstNameStrip
-- listLength = topSpace + pFirstNameStrip.myLength + bottomSpace

fitInHeight = pViewHeight - 15 - 15
pIndexImg = generateIndexStrip(fitInHeight)
hasIndexStrip = TRUE

return me
end

on setFineScroll me, scr

  fineScrollPos = scr

  scrollPos = integer(fineScrollPos)

end

on draw me

  draw pCurrentStrip, rect(0, 0, pViewWidth, pViewHeight), - scrollPos + topSpace
  --draw pFirstNameStrip, rect(0, 0, pViewWidth, pViewHeight), scrollPos - topSpace

  tRect = pIndexImg.rect.offset(pViewWidth - 18, 15)
  copyPixels pDrawBuffer, pIndexImg, tRect, pIndexImg.rect

end

on selectItemAt me, ps

  --put "clickAt" && ps

  y = ps.locV + scrollPos - topSpace

  selectItemIn pLastNameStrip, y

end
```

F-5

```
on getScrollForIndexY me, y
  i = 1 + integer(26.0 * (y - 15) / pIndexImg.rect.height - 0.5)
  if (i < 1) then i = 1
  if (i > 26) then i = 26

  scr = topSpace

  lc = count(pCurrentStrip.myLetterGroups)
  repeat with k = 1 to lc
    num = pCurrentStrip.myLetterGroups[k].myLetterNum
    if (num >= i) then
      exit repeat
    else
      scr = scr + pCurrentStrip.myLetterGroups[k].myLength
    end if
  end repeat

  -- limit scroll
  max = listLength - pViewHeight
  if (scr < 0 ) then scr = 0
  if (scr > max) then scr = max

  return scr
end
```

```
on generateFirstnameStrip me -- FIRST name

  sortNums = value(field("sort first name nums"))

  pFirstNameStrip = new(script("strip object"), me)

  letterGroup    = 0
  lastLetterNum  = 0

  repeat with p = 1 to pNameCount
    n = sortNums[p]
```

```

theName = pNameStrings[n]

letterNum = the charToNum of (char 1 of theName)

if (letterNum > 96) then letterNum = letterNum - 96
if (letterNum > 64) then letterNum = letterNum - 64

if (letterNum <> lastLetterNum) then
  lastLetterNum = letterNum

  if (letterGroup <> 0) then
    calcGroupLength letterGroup
    add pFirstNameStrip.myLetterGroups, letterGroup
  end if

  -- start new group
  letterGroup = new(script("alt letter group object"), me, letterNum)
  letterGroup.myItemheight = pItemHeight
end if

add letterGroup.myItems, n

end repeat

if (letterGroup <> 0) then
  calcGroupLength letterGroup
  --letterGroup.myLength = letterGroup.myHeaderH + pItemHeight * itemCount
  add pFirstNameStrip.myLetterGroups, letterGroup
end if

calcStripLength pFirstNameStrip

end

on generateLastnameStrip me -- LAST name

pLastNameStrip = new(script("strip object"), me)

letterGroup = 0
lastLetterNum = 0

repeat with n = 1 to pNameCount
  theName = pLastNameStrings[n]

  letterNum = the charToNum of (char 1 of theName)

  if (letterNum > 96) then letterNum = letterNum - 96
  if (letterNum > 64) then letterNum = letterNum - 64

```

F-7

```
if (letterNum <> lastLetterNum) then
  lastLetterNum = letterNum

  if (letterGroup <> 0) then
    calcGroupLength letterGroup
    add pLastNameStrip.myLetterGroups, letterGroup
  end if

  -- start new group
  letterGroup = new(script("letter group object"), me, letterNum)
  letterGroup.myItemheight = pItemHeight
end if

add letterGroup.myItems, n

end repeat

if (letterGroup <> 0) then
  calcGroupLength letterGroup
  add pLastNameStrip.myLetterGroups, letterGroup
end if

calcStripLength pLastNameStrip

end
```

```
on generateIndexLetters me
```

```
pCapImgList = []
capTagMem = member("cap item")
```

```
pAltCapImgList = []
altCapTagMem = member("alt cap item")
```

```
caps = "ABCDEFGHIJKLMNOPQRSTUVWXYZ"
```

```
repeat with n = 1 to 26
  capTagMem.text = char n of caps
  add pCapImgList, duplicate(capTagMem.image)

  altCapTagMem.text = char n of caps
  add pAltCapImgList, duplicate(altCapTagMem.image)
end repeat
```

```
pBlueBarImg = duplicate(member("blue bar").image)
pBlueBadgeImg = duplicate(member("bluebadge").image)
```

end

on generateBoldNameBitmaps me

```

pNameStrings      = []
pLastNameStrings = []

pNameBitmaps      = []
pLastNameOffsets  = []

tagMem             = member("name tag")
tagMem.width       = pMaxNameWidth
tagMem.height      = 23
tagMem.fontSize    = 17
tagMem.text        = ",Ä¶ "
pElysisWidth      = tagMem.charPosToLoc(2).locH

```

repeat with n = 1 to pNameCount

```

theName           = line n of pLastNameList
theFirstName      = line n of pFirstNameList

```

```

add pLastNameStrings, theName
add pNameStrings, theFirstName

```

```

tagMem.text       = theFirstName & " "
tagMem.fontStyle  = []

```

```

c = theName.word.count

```

```

lastNameLtrPos = 0

```

```

if (c = 1) then
  --tagMem.fontStyle = [#bold]
else
  if (c = 2) then
    if (theFirstName.word[2] = theName.word[1]) then
      tagMem.word[2].fontStyle = [#bold]
      lastNameLtrPos = theFirstName.word[1].chars.count
    else
      --tagMem.fontStyle = [#bold]
    end if
  else

```

```

    if (c = 3) then

```

```

      if (theFirstName.word[3] = theName.word[1]) then

```

```
tagMem.word[3].fontStyle = [#bold]
lastNameLtrPos = theFirstName.word[1..2].chars.count

if (theFirstName.word[2] = theName.word[2]) then
  tagMem.word[2].fontStyle = [#bold]
  lastNameLtrPos = theFirstName.word[1].chars.count
end if

else

  if (theFirstName.word[3] = theName.word[2]) then

    if (theFirstName.word[2] = theName.word[1]) then
      tagMem.word[2].fontStyle = [#bold]
      lastNameLtrPos = theFirstName.word[1].chars.count
    else
      tagMem.word[3].fontStyle = [#bold]
      lastNameLtrPos = theFirstName.word[1..2].chars.count
    end if

  end if

end if

else

  if (c = 4) then
    if (theFirstName.word[4] = theName.word[1]) then
      tagMem.word[4].fontStyle = [#bold]
      --lastNameLtrPos = the number of chars of theFirstName.word[1..3]
      lastNameLtrPos = theFirstName.word[1..3].chars.count
    end if
  end if

end if

end if
end if

if (lastNameLtrPos = 0) then tagMem.fontStyle = [#bold]

c      = tagMem.text.chars.count
nameWidth = tagMem.charPosToLoc(c).loch

if (nameWidth > pMaxNameWidth) then
  tooMuch = (nameWidth - pMaxNameWidth) + pElypsisWidth

  if (lastNameLtrPos > 0) then -- first name trunc
    startPos = lastNameLtrPos + 1
  else -- end trunc
```

```

    startPos = c
end if

x2 = tagMem.charPosToLoc(startPos).locH
pos = startPos - 1

repeat while (TRUE)
    x1 = tagMem.charPosToLoc(pos).locH
    if (x2 - x1 > tooMuch) then exit repeat
    pos = pos - 1
end repeat

a = pos + 1
b = startPos - 1
delete tagMem.char[a..b]
tagMem.char[pos] = ",Ä¶"

if (lastNameLtrPos > 0) then lastNameLtrPos = a - 1
end if

delete tagMem.char[c]

tagMem.width = nameWidth

add pNameBitmaps, duplicate(tagMem.image)

if (lastNameLtrPos > 0) then
    lastNameOffset = tagMem.charPosToLoc(lastNameLtrPos + 2).locH
else
    lastNameOffset = 0
    --tagMem.char[1].fontStyle = [#bold]
    --tagMem.fontStyle = [#bold]

    --    tagMem.text = tagMem.text & " "
    --    tagMem.fontStyle = [#bold]
    --
    --    c = the number of chars of tagMem.text
    --    lastNameOffset = tagMem.charPosToLoc(c).locH / 2
    --    delete tagMem.char[c]
end if

add pLastNameOffsets, lastNameOffset
end repeat

end

```

on generateNameBitmaps me

```

pNameStrings      = []
pLastNameStrings = []

pNameBitmaps     = []
pLastNameOffsets = []

tagMem           = member("name tag")
tagMem.width     = pMaxNameWidth
tagMem.height    = 23
tagMem.fontSize  = 17
tagMem.text      = ",Ä¶ "
pElypsisWidth   = tagMem.charPosToLoc(2).loch

```

repeat with n = 1 to pNameCount

```

theName      = line n of pLastNameList
theFirstName = line n of pFirstNameList

```

```

add pLastNameStrings, theName
add pNameStrings, theFirstName

```

```

tagMem.text      = theFirstName & " "
tagMem.fontStyle = []

```

```

c = theName.word.count

```

```

lastNameLtrPos = 0

```

```

if (c = 1) then

```

```

else

```

```

  if (c = 2) then

```

```

    if (theFirstName.word[2] = theName.word[1]) then

```

```

      lastNameLtrPos = theFirstName.word[1].chars.count

```

```

    end if

```

```

  else

```

```

    if (c = 3) then

```

```

      if (theFirstName.word[3] = theName.word[1]) then

```

```

        lastNameLtrPos = theFirstName.word[1..2].chars.count

```

```

      if (theFirstName.word[2] = theName.word[2]) then

```

```

        lastNameLtrPos = theFirstName.word[1].chars.count

```

```

      end if

```

```

    else

```



```

if (theFirstName.word[3] = theName.word[2]) then

  if (theFirstName.word[2] = theName.word[1]) then
    lastNameLtrPos = theFirstName.word[1].chars.count
  else
    lastNameLtrPos = theFirstName.word[1..2].chars.count
  end if

end if

end if

else

  if (c = 4) then
    if (theFirstName.word[4] = theName.word[1]) then
      lastNameLtrPos = theFirstName.word[1..3].chars.count
    end if
  end if

end if

end if
end if

c      = tagMem.text.chars.count
nameWidth = tagMem.charPosToLoc(c).loch

if (nameWidth > pMaxNameWidth) then
  tooMuch = (nameWidth - pMaxNameWidth) + pElypsisWidth

  if (lastNameLtrPos > 0) then -- first name trunc
    startPos = lastNameLtrPos + 1
  else -- end trunc
    startPos = c
  end if

  x2 = tagMem.charPosToLoc(startPos).loch
  pos = startPos - 1

  repeat while (TRUE)
    x1 = tagMem.charPosToLoc(pos).loch
    if (x2 - x1 > tooMuch) then exit repeat
    pos = pos - 1
  end repeat

  a = pos + 1
  b = startPos - 1
  delete tagMem.char[a..b]
  tagMem.char[pos] = ",Ä¶"

```

```
    if (lastNameLtrPos > 0) then lastNameLtrPos = a - 1
end if

delete tagMem.char[c]

tagMem.width = nameWidth

add pNameBitmaps, duplicate(tagMem.image)

if (lastNameLtrPos > 0) then
    lastNameOffset = tagMem.charPosToLoc(lastNameLtrPos + 2).locH
else
    lastNameOffset = 0
end if

add pLastnameOffsets, lastNameOffset
end repeat

end
```

strip object (Internal)

property mySuper

property myLetterGroups, grpCount, myLength
property kLightBGcol

on new me, ms
mySuper = ms

kLightBGcol = rgb(245, 248, 254)

myLetterGroups = []
myLength = 0

return me
end

on calcStriplength me
myLength = 0

repeat with grp in myLetterGroups
myLength = myLength + grp.myLength
end repeat

grpCount = count(myLetterGroups)
end

on alternateColors me
repeat with n = 1 to grpCount
if (n mod 2 = 0) then
myLetterGroups[n].mBgCol = rgb(225, 225, 225)
else
myLetterGroups[n].mBgCol = rgb(255, 255, 255)
end if
end repeat
end

on selectItemIn me, posY

--y = pos.locV - scrollPos + topSpace

--selectItemAt pLastNameStrip, y

--put "click pos down list" && posY

```
yy = 0
```

```
repeat with n = 1 to grpCount
```

```
  grp = myLetterGroups[n]
```

```
  if ((posY >= yy) and (posY < yy + grp.myLength)) then
```

```
    selectItemAtY grp, posY - yy
```

```
    exit repeat
```

```
  end if
```

```
  yy = yy + grp.myLength
```

```
end repeat
```

```
end
```

```
on draw me, inRect, scrollPos
```

```
  y = scrollPos
```

```
  if (y > 0) then
```

```
    r = duplicate(mySuper.pDrawBuffer.rect)
```

```
    r.bottom = y
```

```
    fill mySuper.pDrawBuffer, r, kLightBGcol
```

```
  end if
```

```
  startN = 0
```

```
  repeat with n = 1 to grpCount
```

```
    grp = myLetterGroups[n]
```

```
    if (y + grp.myLength > inRect.top) then
```

```
      startN = n
```

```
      exit repeat
```

```
    else
```

```
      y = y + grp.myLength
```

```
    end if
```

```
  end repeat
```

```
  inRectFilled = FALSE
```

```
if (startN > 0) then
  repeat with n = startN to grpCount
    grp = myLetterGroups[n]

    draw grp, inRect, y

    y = y + grp.myLength

    if (y > inRect.bottom) then
      inRectFilled = TRUE
      exit repeat
    end if
  end repeat
end if

if (not inRectFilled) then
  if (y < inRect.bottom) then
    r = duplicate(mySuper.pDrawBuffer.rect)
    r.top = y
    fill mySuper.pDrawBuffer, r, kLightBGcol
  end if
end if

end

--on draw me, inRect, scrollPos
--
-- y = -scrollPos
--
--
-- if (y > 0) then
--   r = duplicate(mySuper.pDrawBuffer.rect)
--   r.bottom = y
--   fill mySuper.pDrawBuffer, r, kLightBGcol
-- end if
--
--
-- drawing      = FALSE
-- inRectFilled = FALSE
--
-- repeat with n = 1 to grpCount
--
--   grp = myLetterGroups[n]
--
--   if (not drawing) then
--     if (y + grp.myLength > inRect.top) then drawing = TRUE
--   end if
```

F-17

```
--  
--   if (drawing) then draw grp, inRect, y  
--  
--   y = y + grp.myLength  
--  
--   if (y > inRect.bottom) then  
--     inRectFilled = TRUE  
--     exit repeat  
--   end if  
--  
-- end repeat  
--  
--  
-- if (not inRectFilled) then  
--   if (y < inRect.bottom) then  
--     r = duplicate(mySuper.pDrawBuffer.rect)  
--     r.top = y  
--     fill mySuper.pDrawBuffer, r, kLightBGcol  
--   end if  
-- end if  
--  
--end
```

letter group object (Internal)

property mySuper

property myLetterNum, myItems, myLength, myItemHeight
property myHeaderH

on new me, ms, letterNum
mySuper = ms

myLetterNum = letterNum
myItemHeight = 0

myItems = []
myLength = 0

myHeaderH = 33

return me
end

on calcGroupLength me
myLength = myHeaderH + myItemHeight * count(myItems)
end

on selectItemAtY me, posY

--put "letNum: " & myLetterNum && posY

if (posY <= myHeaderH) or (posY > myLength) then

--put "out of range"

else

posY = posY - myHeaderH

q = integer(1.0 * posY / myItemHeight + 0.5)

itemRef = myItems[q]

--put mySuper.pNameStrings[itemRef]

mySuper.selectedID = itemRef

end if

end

```
on draw me, inRect, yy

context = mySuper.pDrawBuffer

y = yy

-- fill bg
r = rect(0, 0, inRect.width, myLength).offset(0, y)
fill context, r, rgb(255, 255, 255)

-- draw names
c = count(myItems)
if (c > 0) then
  startN = integer(1.0 * (inRect.top - (yy + myHeaderH)) / myItemHeight + 0.5)
  if (startN < 1) then startN = 1
  if (startN > c) then startN = c

  x = mySuper.pNameXstart

  repeat with n = startN to c
    y = (yy + myHeaderH) + (n - 1) * myItemHeight

    if (y > inRect.bottom) then exit repeat

    -- top line
    --fill context, rect(0, y, inRect.width, y + 1), rgb(240, 240, 240)

    -- name tag
    nameID = myItems[n]
    nameImg = mySuper.pNameBitmaps[nameID]
    nameRect = nameImg.rect
    cof = (myItemHeight - nameRect.height) / 2 --- 2

    if (nameID = mySuper.selectedID) then
      fill context, rect(0, y, inRect.width, y + myItemHeight), rgb( 0, 82, 233 )
      copyPixels context, nameImg, nameRect.offset(x, y + cof), nameRect, [#bgColor: 0]
    else
      copyPixels context, nameImg, nameRect.offset(x, y + cof), nameRect, [#bgColor: 255]
      -- bottom line
      fill context, rect(0, y + myItemHeight - 1, inRect.width, y + myItemHeight), rgb(
240, 240, 240 )
    end if

  end repeat
end if
```



```
-- draw header

y = yy

if (y < inRect.top)           then y = inRect.top
if (y > yy + myLength - myHeaderH) then y = yy + myLength - myHeaderH

hRect = rect(0, 0, inRect.width, myHeaderH).offset(0, y)

copyPixels context, mySuper.pBlueBarImg, hRect, rect(0, 0, 1, myHeaderH), [#blendLevel :
255 * 80 / 100]

-- draw index letter

x = mySuper.pNameXstart - 6
blueBadgeImg = mySuper.pBlueBadgeImg

copyPixels context, blueBadgeImg, blueBadgeImg.rect.offset(x, y + 1), blueBadgeImg.rect

capImg = mySuper.pCapImgList[myLetterNum]
copyPixels context, capImg, capImg.rect.offset(x + 11, y + 3), capImg.rect, [#bgcolor: 0,
#blendLevel: 255]

end
```

14 (Internal)

```
global gListObject
global TmouseLoc, TmouseLocFine
```

```
property startScrollPos, touchPosAtStart
property scrollSpeed, lastUpdateTime, dontSelect
property startTouchTime, lastTouchTime, lastTouchPos
property scrollTriggered
property hitSelectID
```

```
property indexMode
property dragging
```

```
on beginSprite me
    scrollSpeed      = 0.0
    lastUpdateTime  = the milliseconds
    scrollTriggered  = FALSE
    indexMode       = FALSE
    dragging        = FALSE
end
```

```
on TmouseDown me
```

```
    dragging        = TRUE
    lastTouchTime   = the milliseconds
    startTouchTime  = the milliseconds
```

```
    if (TmouseLoc.locH < sprite(me.spriteNum).right - 30) then
```

```
        indexMode = FALSE
```

```
        dontSelect      = ( abs(scrollSpeed) > 0.05 )
        if (scrollSpeed = 0.0) then scrollTriggered = FALSE
```

```
        startScrollPos  = gListObject.fineScrollPos
        touchPosAtStart = TmouseLocFine
        lastTouchPos    = TmouseLocFine
```

```
        hitSelectID = 0
```

```
    else
```

```
        indexMode = TRUE
```

```
        scrollSpeed      = 0.0
        scrollTriggered  = FALSE
```

```
newScroll = gListObject.getScrollForIndexY(TmouseLoc.locV - sprite(me.spriteNum).top)

setFineScroll gListObject, newScroll
draw gListObject

end if

end

on TmouseDrag me

if (indexMode) then

    newScroll = gListObject.getScrollForIndexY(TmouseLoc.locV - sprite(me.spriteNum).top)

    setFineScroll gListObject, newScroll
    draw gListObject

    exit
end if

currentTouchTime = the milliseconds
currentTouchPos = TmouseLocFine
currentFineScroll = gListObject.fineScrollPos

if (not scrollTriggered) then

    if (currentTouchTime - startTouchTime > 150) then
        if (hitSelectID = 0) then
            sp = sprite(me.spriteNum)
            selectItemAt gListObject, TmouseLoc - point(sp.left, sp.top)
            hitSelectID = gListObject.selectedID
            draw gListObject
        end if
    end if

    if ( abs(currentTouchPos.locV - touchPosAtStart.locV) > 10 ) then
        scrollTriggered = TRUE
        touchPosAtStart = lastTouchPos
        gListObject.selectedID = 0
    end if

    if ( abs(currentTouchPos.locH - touchPosAtStart.locH) > 20 ) then
        dontSelect = TRUE
        gListObject.selectedID = 0
        draw gListObject
    end if
end if
```

```

end if
end if

```

```

if (scrollTriggered) then

```

```

    dt = currentTime - lastTouchTime

```

```

    if (dt > 0) then

```

```

        newScroll = startScrollPos - (currentTouchPos.locV - touchPosAtStart.locV) * 1.0

```

```

        maxScroll = gListObject.listLength - gListObject.pViewHeight

```

```

        if (newScroll < 0) then newScroll = newScroll + 0.5 * (0 - newScroll)

```

```

        if (newScroll > maxScroll) then newScroll = newScroll + 0.5 * (maxScroll - newScroll)

```

```

        repeat with n = 1 to dt

```

```

            newScroll = newScroll + 0.05 * (gListObject.fineScrollPos - newScroll)

```

```

        end repeat

```

```

        scrollSpeed = 1.0 * (newScroll - gListObject.fineScrollPos) / dt

```

```

        setFineScroll gListObject, newScroll

```

```

        draw gListObject

```

```

    end if

```

```

end if

```

```

lastTouchPos = currentTouchPos

```

```

lastTouchTime = currentTime

```

```

end

```

```

on TmouseUpOutside me

```

```

    TmouseUp me

```

```

end

```

```

on TmouseUp me

```

```

    dragging = FALSE

```

```

    if (indexMode) then

```

```

        newScroll = gListObject.getScrollForIndexY(TmouseLoc.locV - sprite(me.spriteNum).top)

```

```

        setFineScroll gListObject, newScroll

```

```

        draw gListObject

```

```
exit
end if
```

```
if (not scrollTriggered) then
```

```
  if (dontSelect) then
```

```
  else
```

```
    --select item
```

```
    sp = sprite(me.spriteNum)
```

```
    selectItemAt gListObject, TmouseLoc - point(sp.left, sp.top)
```

```
    draw gListObject
```

```
    dontSelect = FALSE
```

```
    if (gListObject.selectedID <> 0) then
```

```
      buildCard
```

```
      slideListToCard
```

```
    end if
```

```
  end if
```

```
else
```

```
  selectedID = 0
```

```
  if (abs(scrollSpeed) < 0.25) then
```

```
    scrollSpeed = 0.0
```

```
    scrollTriggered = FALSE
```

```
    dontSelect = FALSE
```

```
  else
```

```
    dontSelect = TRUE
```

```
  end if
```

```
end if
```

```
end
```

```
on exitFrame me
```

```
  currentUpdateTime = the milliseconds
```

```
  dt = currentUpdateTime - lastUpdateTime
```

```
  if (dt > 0) then
```

```

if (not dragging) then
  newScroll = gListObject.fineScrollPos

  maxScroll = gListObject.listLength - gListObject.pViewHeight
  repeat with n = 1 to dt
    scrollSpeed = 0.998 * scrollSpeed
    newScroll = newScroll + scrollSpeed

    if (newScroll < 0) then
      newScroll = newScroll + 0.01 * (0 - newScroll)
      scrollSpeed = 0.990 * scrollSpeed
    end if
    if (newScroll > maxScroll) then
      newScroll = newScroll + 0.01 * (maxScroll - newScroll)
      scrollSpeed = 0.990 * scrollSpeed
    end if
  end repeat

  setFineScroll gListObject, newScroll
  draw gListObject
end if
end if

lastUpdateTime = currentUpdateTime

end

```

Application No. 90/012,304

Declaration Of Bas Ording Under 37 CFR § 1.131 (Jan. 15, 2013)

Exhibit G

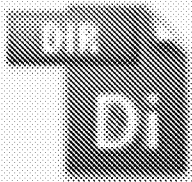

addressBook 15q.dir

2.4 MB

Modified:



PM

Application No. 90/012,304

Declaration Of Bas Ording Under 37 CFR § 1.131 (Jan. 15, 2013)

Exhibit H

Property Inspector

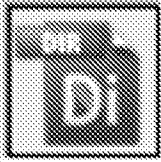

Macintosh HD:Users:basording:Desktop:addressBook 15q.dir



Guides Movie Display Template

Stage Size: 652 X 652

Channels: 128

Color: #000000

Palette: System - Mac

RGB Index

Enable Edit Shortcuts

Preferred 3D Renderer:

Auto

Active 3D Renderer: #openGL

About:

Copyright:

Created By: Bas Ording - Apple



























Modified By: N/A - N/A

Font Map: Save Load

Application No. 90/012,304

Declaration Of Bas Ording Under 37 CFR § 1.131 (Jan. 15, 2013)

Exhibit I

| Name | Date Modified | Date Created | Size |
|--|-----------------------|-----------------------|--------|
|  addressBook 15q.dir | May 14, 2005 10:13 PM | May 14, 2005 10:13 PM | 2.4 MB |
|  basic01.dir | May 12, 2005 3:49 PM | May 12, 2005 3:49 PM | 134 KB |
|  calculator 01.dir | May 13, 2005 11:58 AM | May 13, 2005 11:58 AM | 273 KB |
|  calendar 01.dir | May 13, 2005 5:45 PM | May 13, 2005 5:45 PM | 220 KB |
|  calls dial 05.dir | May 14, 2005 10:17 PM | May 14, 2005 10:17 PM | 2 MB |
|  converter 01.dir | May 13, 2005 5:44 PM | May 13, 2005 5:44 PM | 218 KB |
|  flight 01.dir | May 12, 2005 3:49 PM | May 12, 2005 3:49 PM | 233 KB |
|  incom lock 04.dir | May 14, 2005 7:52 PM | May 14, 2005 7:52 PM | 3.6 MB |
|  Mail 2.dir | May 14, 2005 6:30 PM | May 14, 2005 6:30 PM | 6.1 MB |
|  menu.dir | May 17, 2005 5:08 PM | May 17, 2005 5:08 PM | 483 KB |
|  minScreen.dir | May 12, 2005 6:20 PM | May 12, 2005 6:20 PM | 54 KB |
|  Multitouch | Jun 11, 2004 11:37 AM | Jun 11, 2004 11:37 AM | 15 KB |
|  puzzle 01.dir | May 13, 2005 5:46 PM | May 13, 2005 5:46 PM | 321 KB |
|  slideshow 08.dir | May 14, 2005 12:41 AM | May 14, 2005 12:41 AM | 6.4 MB |
|  SMS 5.dir | May 14, 2005 6:30 PM | May 14, 2005 6:30 PM | 4.4 MB |
|  soundCast | May 17, 2005 3:43 PM | May 17, 2005 3:43 PM | 2 KB |
|  Speed Dial 3.dir | May 14, 2005 10:16 PM | May 14, 2005 10:16 PM | 4.9 MB |
|  starter.dir | May 9, 2005 6:36 PM | May 9, 2005 6:36 PM | 36 KB |
|  starter.osx | May 9, 2005 6:36 PM | May 9, 2005 6:36 PM | 4 MB |
|  stocks 01.dir | May 14, 2005 6:12 PM | May 14, 2005 6:12 PM | 1.7 MB |
|  tiny.dir | May 17, 2005 3:28 PM | May 17, 2005 3:28 PM | 10 KB |
|  translator 01.dir | May 13, 2005 5:45 PM | May 13, 2005 5:45 PM | 252 KB |
|  voiceMail 01.dir | May 14, 2005 10:15 PM | May 14, 2005 10:15 PM | 222 KB |
|  weather 03.dir | May 14, 2005 6:26 PM | May 14, 2005 6:26 PM | 778 KB |
|  web.dir | May 14, 2005 6:29 PM | May 14, 2005 6:29 PM | 6.1 MB |
|  yellowpages 01.dir | May 13, 2005 11:57 AM | May 13, 2005 11:57 AM | 203 KB |

IN THE UNITED STATES PATENT AND TRADEMARK OFFICE

| | | |
|--|-------------------|---------------------------------|
| In the Reexamination of USP 7,469,381) | Confirmation No.: | 4807 |
| to Ording) | | |
| Control No.: 90/012,304) | Group Art Unit: | 3992 |
| Reexam Request Filed: 5/23/2012) | Examiner: | Bonshock, Dennis |
| For: LIST SCROLLING AND) | Attorney Docket: | |
| DOCUMENT TRANSLATION,) | | P4304USREX2/120730-002US |
| SCALING, AND ROTATION ON A) | | |
| TOUCH-SCREEN DISPLAY) | | |
| _____) | | |

Mail Stop Ex Parte Reexam
 Central Reexamination Unit
 Commissioner for Patents
 United States Patent & Trademark Office
 P.O. Box 1450
 Alexandria, VA 22313-1450

Declaration Of Greg Christie Under 37 CFR § 1.131

I, Greg Christie, declare as follows:

1. I am the head of the Human Interface group at Apple Inc., and have been since before 2005.
2. I have worked closely with Bas Ording for many years. His office at Apple in Cupertino is in close physical proximity to my own and he has been one of the senior employees under me in Human Interface since before 2005.
3. Much of my work and the work of Mr. Ording and other people working in Human Interface is devoted to improving computer device user interfaces ("UI"). The way that such user interfaces are generally tested, by their very nature, is by operating them and using them. In other words, during testing, a user uses the UI to interface with a computer device in a desired manner and evaluate whether it works as intended.

4. During the time before on or about May 15, 2005, I was working with Mr. Ording, Apple CEO Steve Jobs, and many other persons at Apple on the highly confidential development of a multi-function touch screen device that eventually became the iPhone. At Mr. Jobs' request, team members including Mr. Ording had recently started focusing on developing such a device with a phone-sized touch screen small enough that the device screen could be the size of a mobile phone.

5. During that time, to my personal knowledge as head of the Human Interface group, Mr. Ording had been working for years with an application called Director that allows programming, testing, and interactive demonstration of user interface programming on computer devices.

6. During the time before on or about May 15, 2005, to my personal knowledge, Mr. Ording had been writing UI code and testing it with a touch screen device attached to his computer in his office, and I often discussed or tested such UIs he developed with him as part of my job as head of the Human Interface group.

7. During that time, Mr. Ording did a demonstration for me of some UI functions involving scrolling a list of names on the touch screen by swiping his finger up or down the screen to move the list up or down respectively. The names in the vertical list appeared alphabetically in rectangles of alternating shades. When he scrolled to the top of this list, the list would not scroll beyond the top of the list, and when he scrolled to the bottom of this list, the list would not scroll beyond the bottom of the list. In other words, there was no space displayed beyond the borders of the list: scrolling would stop at the extremity of the list and go no farther.

8. Sometime after the demonstration mentioned above but before about May 15, 2005, Mr. Ording did further demonstration tests for me, as well as Mr. Jobs, of an improved UI, involving the contact list described above, that let the user scroll past the top edge or bottom edge of the list.

9. Mr. Ording let me operate these new UI features successfully, and see how they worked. I personally thought they were useful and appealing.

10. Mr. Jobs told me and Mr. Ording that he wanted the touch screen device demonstrated, including these UI features on the scrollable contact list, at a meeting of dozens of select Apple employees to be held in May 2005. Mr. Ording continued to refine his program for this functionality, and from time to time before about May 15, 2005, would demonstrate to me the current functionality of the scrollable contact list's UI features.

11. On May 14, 2005 and into the evening, soon before the "Big Demo," which by now the team referred to as "the Big Demo," Mr. Ording finished his code revisions, worked closely with me on testing them, and demonstrated to me, in person, using Director on his computer having an attached touch screen, the refined functionality of this UI, having "rubberbanding" features that made it appear as if the edges of the list were attached to the edges of the screen by rubber bands. "Rubberbanding" is one of the names used at Apple as convenient shorthand to refer to these features. These were the same features that would be demonstrated, on the same computer, using Director running the same code.

12. Working closely with Mr. Ording on this testing on the evening of May 14, 2005, I personally witnessed and verified that the UI code that Mr. Ording prepared the evening before the demonstration to be used at the "Big Demo," successfully demonstrated at least the following features: When the user scrolled to reveal additional content from the top of the screen (by swiping his finger downward to move the list of items downward on the screen), the top of the list eventually reached the display window. While his finger continued to move downward, the list would continue down the screen in damped fashion, as if it were meeting some resistance, and an additional area of a different color would come into view above the list. Instead of the list filling the display window as before, part of the display window displayed a portion of the list and part of the display window displayed an additional area beyond the portion of the list, so the portion of the list we could see then was smaller than the portions we could see previously. Then, when the finger was lifted off the screen, the list promptly moved back upward, in a damped fashion, until the area beyond the list could no longer be seen, and all that could be seen was the list flush against the top of the screen.

Analogous operations occurred at the bottom of the list, with the directions being reversed.

13. Having personally witnessed and verified the tests of this functionality on or about May 15, 2005, I emailed Scott Forstall at Apple on May 15, 2005, copying, among other people, Mr. Ording, a list of my notes of the features of the demonstration. Under the heading "address book," I made the following statement, which I emphasized in my email with italics and bold type to emphasize that the tests I had personally witnessed of the scrolling contacts list with the "rubberbanding" UI had been successful:

all contacts is a fully functional scrolling list demo

A true copy of my email containing this statement is attached as Exhibit A which shows that I witnessed this successful test by about May 15, 2005.

14. I was informed that, with approximately 100 Apple employees in attendance, including Mr. Jobs, a demonstration test was successfully performed of Mr. Ording's fully functional scrollable contact list UI, using the same computer, touch screen display, and code that had been used for the successful test of the same UI that I had personally witnessed on the previous day.

15. After this demonstration, Mr. Jobs, Mr. Ording, I, and the rest of the team continued developing the phone device, including the "rubberbanding" UI, into the product that became the iPhone.

16. All the events described above took place in California, in the United States.

17. I hereby declare that all statements made herein of my own knowledge are true and that all statements made on information and belief are believed to be true; and further that these statements were made with the knowledge that willful false statements and the like so made are punishable by fine or imprisonment, or both, under Section 1001 of the Title 18 of the United States Code and that such willful false statements may jeopardize the validity of the patent under reexamination.

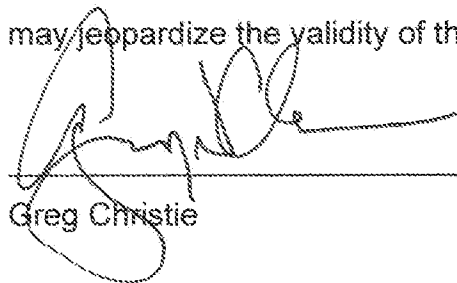

Greg Christie

Date: 1/15/2013

Application No. 90/012,304

Declaration Of Greg Christie Under 37 CFR § 1.131

Exhibit A

Subject: BIG demo notes

Date: Sun, 15 May 2005 02:35:56 -0700

From: "Greg Christie" <christie@apple.com>

To: "Scott Forstall" <forstall@apple.com>

Cc: "Bas Ording" <bas@apple.com>, "patrick coffman" <pcoffman@apple.com>

Message-ID: <56BC1839-935E-4A5B-800B-D40900165899@apple.com>

menu

- menu alternates where you are to menu -- use this to get out of anything

incoming call

- secret button is lower left corner for incoming call
- press and hold, screen blacks out
- tap the screen for an incoming call
- slide to unlock
- then accept or decline
- after call, screen re-locks
- press menu to go back to everything else

keypad

- clear works to erase a number
- call works
- when in a call
- tap to toggle hold
- tap to toggle speaker
- tap to end call

address book

- the first time address book is opened you can't do anything for a 1/2 or 1 second while it loads
- any of the groups will take you to all contacts
- *all contacts is a fully functional scrolling list demo*
- can go back to groups
- index letters work
- tap name to get card
- tap phone number to call
- back & forth between groups, all contacts, and single entry

speed dial

- any tap on the list calls john appleseed
- end call, go back to speed dial list
- tap on right side to show john appleseed's card
- can go back to speed dial
- any press in bottom bar does an "add"
- pick john appleseed, pick mobile number
- second tap in bottom bar puts in edit mode
- tap minus to remove last john appleseed; tap remove; then done

ipod

- opens in top level (iPod)
- the first time iPod is opened you can't do anything for a second or two while it loads.
- tap playlists, go back
- tap artists -> beatles -> Sgt. Pepper->Fixing a hole (back works in all of this)
- tap albums, go back
- *songs is a fully functional scrolling demo, index letters, etc..*
 - can play any song, go back to songs, play another, etc*
- Now playing display shows album art, progress bar, etc...

now playing only works in songs and in iPod
volume works everywhere
play/pause work everywhere

mail

- flip between split view and column view
- tap to get message from john appleseed
- tap name john appleseed to see his card, and go back
- tap info button to see addressees
- tap info button again to collapse addresses
- "file message" works. tap john appleseed in list again to get back to message
- delete works; tap john appleseed to go back to message
- "reply" works; hit any of the reply buttons brings up the reply; press info button, add an addressee; send this message or delete it
- new message works; press plus to add john appleseed; choose an email address; send this message or cancel it

sms

- tap person in the list to look at the sms message from john appleseed
- tap keyboard to add response
- tap keyboard to send it
- tap keyboard again to see reply
- at any time "delete" or go back to list
- create new sms message; tap plus button; tap addressee; pick phone number; tap keyboard to type; tap keyboard again to send
- go back to menu

ical

- just shows calendar

voicemail

- shows call in progress to voicemail server

web/safari

- shows a webpage
- tap to zoom
- tap for text field focus & show keyboard
- tap to dismiss keyboard
- tap zooms out

- demo loops from there

weather

- tap right edge to cycle right
- tap left edge to cycle left

stocks

- tap on any stock to see a chart
- drag through the list

yellow pages

- just shows yellow pages

calculator

- just shows calculator

unit converter

- just shows unit converter

translator

- just shows translator

tile puzzle

- just shows tile puzzle

slide show

- tap shows the index view
- tap any picture to show that picture; this will start the slide show
- tap to bring up OSD controls
- next/next or previous/previous or play/pause or go back to index
- OSD fades out after a few seconds
- as long as it is in play it will cross fade between slides

flight tracker

- just shows flight tracker

----- end message -----

Application No. 90/012,304

Declaration under 35 U.S.C § 132 of Prof. Brad A. Myers, Ph.D.

Exhibit 1

Brad A. Myers

Office:

Human-Computer Interaction Institute
 School of Computer Science
 Carnegie Mellon University
 Pittsburgh, PA 15213-3891
 (412) 268-5150
 FAX: (412) 268-1266
 E-mail: bam@cs.cmu.edu
 WWW: <http://www.cs.cmu.edu/~bam>

- [Research Interests](#)
- [Experience](#)
 - [Consulting](#)
 - [Legal Consulting](#)
- [Education](#)
- [Awards and Honors](#)
- [Research Grants](#)
- [Publications](#)
- [Articles About Me](#)
- [Professional Activities](#)
- [CMU Activities](#)
- [Teaching](#)
- [Students](#)
- [Invited Presentations](#)

Research Interests:

User Interface Software, Hand-held computers, Demonstrational Interfaces, User Interface Design, Window Managers, Visual Programming, Programming Environments, End-User Software Engineering.

Experience:

Human Computer Interaction Institute

Professor, 2004 - present.

Associate Research Professor, 2003 - 2004.

Senior Research Scientist, 1995 - 2003.

Computer Science Department

Senior Research Computer Scientist, 1992 - 1995.

Research Computer Scientist, July 1987- 1992.

School of Computer Science, Carnegie Mellon University, Pittsburgh, PA

Principal investigator for the Natural Programming Project, funded by NSF and industry, which is creating new programming languages, environments and tools that are easier to learn, more effective, and less error prone. We are taking a human-centered approach, first studying how people perform their tasks and then designing languages and environments around people's natural tendencies. We focus on all kinds of programming, including professional programmers, novice programmers who are trying to learn to be experts, and end users, who program to support other jobs or activities.

Principal investigator for the Pebbles PDA project, funded by DARPA, NSF, SEI and industry, which is investigating the use of hand-held computers like Android smartphones, Pocket PC/Windows CE and PalmOS devices synchronously with PCs. By "synchronously," we mean that one or more hand-helds will be connected to a computer or computerized device, so that the hand-helds will be in continuous two-way communication with the main computer and with each other.

Principal investigator for the Silver Project, funded as part of the second Digital Libraries Initiative, which is investigating authoring with digital video.

Principal investigator for the User Interface Software Project, funded by DARPA and industry, which developed

sophisticated user interface development environments to help build graphical user interfaces. Garnet, our earlier system, is in Lisp, and introduced encapsulating mouse and keyboard behaviors into abstract "interactors." Amulet, the second system, is in C++ and runs on Unix, Windows NT and 95, and Macintosh. Amulet is downloaded about 10,000 times a year, and incorporates novel object, constraint, input, output, undo, command and animation models to provide high-level support for highly-interactive, multi-media applications for one or multiple users. An important focus is high-level graphical editors which allow the user interface designer to draw all graphical aspects of user interfaces, and to demonstrate most of the behavior of the user interface.

Principal investigator for the Demonstrational Interfaces project, funded by NSF and industry. In a "demonstrational interface," the user gives an example of how the system should operate, and the system automatically generalizes from the example to produce a parameterized procedure. For instance, in the Macintosh Finder, the user might move "foo.PS" and then "bar.PS" to the trash can. The system might notice that a similar operation was performed twice and automatically create a procedure to delete all the "*.PS" files. We are developing a demonstrational visual shell (iconic desktop), a text formatter, an editor for business charts, an editor for dynamic world-wide-web pages, and an architecture for programs that support demonstrational interfaces.

MacGnome project (1987-1988): designed a system that creates visualizations for Pascal data structures.

Consultant

1984-present:

1. **White & Case LLP**, New York, NY
2. **Rothwell, Figg, Ernst & Manbeck, P.C.**, Washington, DC
3. **Klemchuk Kubasta LLP**, Dallas, TX
4. **Feinberg Day Alberti & Thompson, LLP**, Palo Alto, CA
5. **Finnegan, Henderson, Farabow, Garrett & Dunner, LLP**, Washington, DC
6. **Rubin/Anders Scientific, Inc.**, Brookline, MA
7. **Kellogg, Huber, Hansen, Todd, Evans & Figel, P.L.L.C.**, Washington, DC
8. **Oblon, Spivak, McClelland, Maier & Neustadt, L.L.P.**, Alexandria, VA
9. **McDermott Will & Emery LLP**, Irvine, CA
10. **Mayer Brown LLP**, Palo Alto, CA
11. **IMS ExpertServices**, Pensacola, FL
12. **Sughrue Mion, PLLC**, Washington, DC
13. **Simmons & Simmons**, London, United Kingdom
14. **Latham & Watkins LLP**, Los Angeles, CA
15. **Sidley Austin LLP**, Dallas, TX
16. **Ropes & Gray LLP**, Washington, DC
17. **Adobe Systems Inc.**, San Jose, CA
18. **National Expert Witness Network**, Paradise, CA
19. **McKool Smith**, Austin, TX
20. **Morris, Nichols, Arsht & Tunnell**, Wilmington, DE
21. **Thompson & Knight L.L.P.**, Dallas, TX
22. **Emerson Process Management**, Austin, TX
23. **Clairvoyance Corporation**, Pittsburgh, PA
24. **Wilmer Cutler Pickering Hale and Dorr LLP**, Boston, MA
25. **University of Pittsburgh Dept. of Nursing**, Pittsburgh, PA
26. **Cooley Godward LLP**, Reston, VA
27. **Level 3 Communications**, Broomfield, CO
28. **Cesari and McKenna**, Boston, MA
29. **Fish & Richardson**, Boston, MA, San Diego, CA and Washington, D.C.
30. **Darby & Darby**, New York, NY

31. **Samsung Electronics**, Seoul, Republic of Korea
32. **Morrison & Foerster**, San Diego, CA
33. **Jones, Day, Reavis & Pogue**, Dallas, Texas
34. **Weil, Gotshal & Manges**, Menlo Park, CA
35. **Fenwick & West**, Palo Alto, CA
36. **Kirkland & Ellis**, Los Angeles, CA
37. **Silicon Valley Expert Witness Group Inc.**, Mountain View, CA
38. **Jenkins & Gilchrist**, Dallas, TX
39. **Merchant & Gould**, Minneapolis, MI
40. **GlobalOne**, Reston, VA
41. **Lindquist & Vennum**, Minneapolis, MI
42. **Wilson Sonsini Goodrich & Rosati**, Palo Alto, CA
43. **Klarquist, Sparkman & Campbell**, Portland, OR
44. **Leydig, Voit & Mayer, Ltd**, Chicago, IL
45. **Maya Design Group** Pittsburgh, PA
46. **McDonnell Boehnen Hulbert & Berghoff**, Chicago, IL
47. **Serviceware, Inc.**, Pittsburgh, PA
48. **Secure Computing Corp.**, Roseville, MN
49. **Venable, Baetjer and Howard, LLP**, Baltimore, MD
50. **AT&T General Solicitor Organization**, NJ
51. **Signal Software**, Pittsburgh, PA
52. **Visual Interface**, Pittsburgh, PA
53. **Nixon & Vanderhuyse P.C.**, Arlington, VA
54. **PROMIS Systems Corp.**, Toronto, Ont, Canada
55. **Emerson Advanced Materials Ctr**, Columbus, OH
56. **Boeing Advanced Tech. Center**, Seattle, WA
57. **Virtual Prototypes, Inc.** Montreal, Canada
58. **Apple Computer, Inc.** Cupertino, CA
59. **Teklicon, Inc.** Mountain View, CA
60. **EJV Partners**, New York, NY
61. **Horizon Research, Inc.** Waltham, MA
62. **Carnegie Group, Inc.** Pittsburgh, PA
63. **Brown and Bain**, Palo Alto, CA
64. **Microsoft**, Redmond, WA
65. **Formative Technologies, Inc.** Pittsburgh, PA
66. **MegaScan**, Gibsonia, PA
67. **Expert Technologies, Inc.**, Pittsburgh, PA
68. **Behavioural Team**, Toronto, Canada
69. **Ashton-Tate, Inc.** Torrance, CA
70. **Eaton Corporation**, Los Angeles, CA
71. **Program Products Ltd**, London, England
72. **Institute for Defense Analyses**, Alexandria, VA
73. **Infodetics**, Anaheim, CA
74. **Ventura Technologies**, Toronto, Canada
75. **PERQ Systems Corporation**, Pittsburgh, PA

Advise on user interface design, user interface software, window manager design and implementation. Perform usability analyses and redesign of products.

Intellectual property consulting for software and user interface patents. Reports, depositions and trial testimony on claim construction, infringement, prior art, and validity. [A list of my testimony is in a separate document.](#)

[PhotoByte Inc.](#), San Francisco, CA
Advisor, UI/UX, 2012-present

SachManya LLC, Sunnyvale, CA

Strategic User Interface Advisor, Web and Mobile, 2010-present

Manchester Business School, The University of Manchester, Manchester, UK

Visiting Professor, 2007-2008.

EkaTetra Corporation, (formerly Clarinet Keyboard Corporation), Portland, OR

Technical Member of the Advisory Committee, 2001-present

Helium Networks, Pittsburgh, PA

Member of the Scientific Advisory Board, 2004-2006

SCIconics, Inc., Pittsburgh, PA

Member of the Advisory Board, 2002-2005

Eizel Corporation, Pittsburgh, PA

Member of the Advisory Board, 2001-2003

PERQ Systems Corporation, Pittsburgh, PA

(formerly **Three Rivers Computer Corporation**)

Senior Software Engineer, 1980-1983.

Designed and implemented the Sapphire Window Manager, which was one of the first commercial window systems and featured full covered windows, a novel use of icons and percent-done progress indicators. Designed and implemented the PERQ directory structure for a hierarchical file system including a Scavenger program to correct file system inconsistencies. Also designed and implemented the PERQ's Pascal debugger, a comprehensive user interface package, various graphical editors, demonstration programs, and games.

Xerox Palo Alto Research Center, Palo Alto, CA

Research Intern, Summer 1977, Summer 1978, and Summer/Fall 1979

Developed a system called Incense which automatically created graphical, pictorial displays for data structures based on their types. Implemented Ethernet protocols in Smalltalk.

Education:

University of Toronto, Toronto, Ontario, Canada

1983-1987.

PhD in Computer Science, May, 1987. Was a Teaching Assistant for computer graphics courses. Grade point average for course work = A+.

Massachusetts Institute of Technology, Cambridge, Massachusetts

1975-1980.

Received Master of Science in Computer Science and Bachelor of Science in Computer Science and Engineering in 1980. Did Master's thesis on Incense while an intern at Xerox PARC. Worked at MIT Architecture Machine Group, 1976-1979. Final grade point average: 5.0 out of 5.0 (A+)

Awards and Honors:

IEEE Fellow, 2013, "for development of software tools for human-computer interaction." [IEEE 2013 List](#), and the [CMU press release](#).

[Most Influential Paper Award](#) for important influences on VL/HCC research or commerce over the last 10+/-1

years by the *IEEE Symposium on Visual Languages and Human-Centric Computing* in 2012, for "Using HCI techniques to design a more usable programming system", Pane, J.F., Myers, B.A., and Miller, L.B., from *HCC'2002*

Nominated for Most Influential Paper Award for important influences on VL/HCC research or commerce over the last 10+/-1 years by the *IEEE Symposium on Visual Languages and Human-Centric Computing* in 2012, for "Development and evaluation of a model of programming errors", Ko, A.J. and Myers, B.A., from *HCC 2003*.

Nominated for the Most Influential Paper Award for important influences on VL/HCC research or commerce over the last 10+/-1 years by the *IEEE Symposium on Visual Languages and Human-Centric Computing* in 2011, for "Tabular and textual methods for selecting objects from a group", Pane, J.F. and Myers, B.A., from *VL'2000*

Honorable Mention Award in the Best Paper Contest at the International Conference on Intelligent User Interfaces (IUI 2010) for: Andrew Faulring, Brad Myers, Ken Mohnkern, Bradley Schmerl, Aaron Steinfeld, John Zimmerman, Asim Smailagic, Jeffery Hansen, and Daniel Siewiorek. "Agent-Assisted Task Management that Reduces Email Overload," Hong Kong, China. Feb 7–10, 2010.

First place in the "Yahoo! Undergraduate Research Awards" competition at Carnegie Mellon University, May 6, 2009, for Daniel S. Eisenberg, Jeffrey Stylos, and Brad Myers, "Apatite: An Associative Search Tool for Exploring the Java API".

Best Research Award, Non-Physician Category at ISHLT: The International Society for Heart & Lung Transplantation, April 9-12, 2008, for: A. DeVito Dabbs, M.A. Dew, B.A. Myers, R.P. Hawkins, D. Ren, A. Begey, R. Zomak, K.L. Lo Coco, K.R. McCurry. "A Randomized Controlled Pilot Trial of PocketPATH on Early Self-Care Behaviors and HRQoL After Lung Transplant."

ACM SIGSOFT Distinguished Paper Award at the 30th International Conference on Software Engineering (ICSE'2008) for "Debugging, Reinvented: Asking and Answering Why and Why Not Questions about Program Behavior" by Andrew J. Ko and Brad A. Myers. May, 2008.

University of Pittsburgh School of Nursing's Nursing Excellence in Teaching and Technology (NETT) Award for 2007 to PocketPATH, by Annette De Vito Dabbs, Brad A. Myers, Kenneth R. McCurry, Jacqueline Dunbar-Jacob, Robert P. Hawkins, Mary Amanda Dew.

CHI 2006 Best Paper, awarded by SIGCHI, for "Trackball Text Entry for People with Motor Impairments," by Jacob O. Wobbrock and Brad A. Myers.

Designated an *ACM Fellow*, 2005. ([citation](#)) and ([press release](#))

Elected to the CHI Academy, April, 2004, as one of the top 25 "principal leaders of the field" of HCI.

Distinguished Paper Award at the 27th International Conference on Software Engineering (ICSE'05) for "Eliciting Design Requirements for Maintenance-Oriented IDEs: A Detailed Study of Corrective and Perfective Maintenance Tasks" by Andrew J. Ko, Htet Htet Aung, and Brad A. Myers. May, 2005.

Elected to the grade of Senior Member, IEEE (September, 2004).

First place in the 2004-2005 NISH National Scholar Awards for Workplace Innovation & Design, to Jacob Wobbrock, supervised by Brad Myers. Press release as [pdf](#)

Best Paper Award at the ACM SIGACCESS Conference on Computers and Accessibility (ASSETS '04) for "Text Entry from Power Wheelchairs: EdgeWrite for Joysticks and Touchpads" by Jacob O. Wobbrock, Brad A. Myers, Htet Htet Aung, and Edmund F. LoPresti. October 2004.

Best Student Paper award at USENIX 2000 Annual Technical Conference for "Integrating a Command Shell into a Web Browser" by Robert Miller and Brad Myers. June 2000.

Outstanding Paper Award at USENIX 1999 Annual Technical Conference for "Lightweight Structured Text Processing" by Robert C. Miller and Brad A. Myers. June 1999.

Winner, first place in the "Personal Productivity" category in the ACM Quest for Windows CE Applications, 1999.

Listed in *Marquis Who's Who in America, 2007, 2009, Marquis Who's Who in Finance and Industry, 2004-2005, Marquis Who's Who in the East, 1995-2000, Marquis Who's Who in the World, 1996, Marquis Who's Who in the Media and Communications, 1997-1999, and Marquis Who's Who in Science and Engineering, 1998-2001*. Included in *2000 Outstanding Scientists of the 20th Century*, International Biographical Centre, Cambridge, England.

PhD thesis nominated for ACM annual best dissertation contest. Selected to join Eta Kappa Nu and Tau Beta Pi. IEEE Student Paper contest winner 1978 and 1979. Awarded University of Toronto Open Fellowship. Graduated First Honor Student from Isadore Newman High School, 1975.

My Place in Some Listings:

One of the most published authors in HCI, according to heibib.org and [Microsoft Academic Search](http://academic.research.microsoft.com).

Ranked in the top 5 for all years and in the top 15 for the last 10 years in [Microsoft's Academic Search listing for HCI](http://academic.research.microsoft.com/CSDirectory/author_category_12.htm) based on "H-Index" (http://academic.research.microsoft.com/CSDirectory/author_category_12.htm).

Listed in [The h Index for Computer Science](http://www.cs.ucla.edu/~palsberg/h-number.html): Computer Science researchers who have an h index of 40 or higher according to Google Scholar (<http://www.cs.ucla.edu/~palsberg/h-number.html>).

Research Grants:

- Microsoft Research, 2012, \$1,500 equipment, "Natural Programming for handhelds."
- Adobe Systems Incorporated, 2012: \$24,000 cash; 2011: \$8,500 cash and \$12,995 equipment; and 2007: \$70,000 cash, for "Making Programming Interactive Behaviors More Natural"
- SAP, Inc., 2011: \$160,000 & 2010: \$160,000 & 2009: \$160,000 & 2007: \$160,000. API Usability.
- Software Engineering Institute (SEI), "Edge-Enabled Tactical Systems: User Controlled System Adaptation." Ed Morris, Grace Lewis, Brad Myers, Soumya Simanta, Gene Cahill. 2011-2012.
- Adobe Systems Incorporated, to the Human Computer Interaction Institute as part of the Adobe Academic Alliance. 2012: \$26,250 equipment; 2011: \$56,000 equipment; 2010: \$41,000 equipment; 2009: \$24,520 equipment; 2008: \$53,800 equipment
- NSF. IIS-1116724 "HCC: Small: Better Tools for Authoring Interactive Behaviors," 8/1/2011 - 7/31/2014, \$495,153.
- DARPA ENGAGE Program, "Active Science Learning Through Games", Scott M. Stevens, Michael G. Christel, Christopher Klug, Jesse Schell, Brad Myers, Vincent A.W.M.M. Aleven, Sharon McCoy Carver, Award #N0001412C0071. 6/15/2011 - 2/14/2014. \$1,900,000.
- Microsoft Research, Software Engineering Innovation Foundation (SEIF) Awards 2011, "Better Tools for Authoring Interactive Behaviors", \$35,000. ([Microsoft announcement](#))
- National Instruments, LabVIEW Materials, 2011, \$2860 equipment.
- Software Engineering Institute (SEI) Independent Research and Development (IRAD) project, "Edge-Enabled Tactical Systems." Ed Morris, Soumya Simanta, Dan Plakosh, Brad Myers, Dennis Smith, Scott Tilley. 2010-2011. [web site](#)
- Microsoft Corporation to the Human Computer Interaction Institute, Expression Suite and training, 2010,

- \$14,585 equipment.
- Google. AndroidEDU grant for Pebbles Project, March, 2010. \$1120 equipment.
 - NSF. IGERT. 2009. "Carnegie Mellon Usable Privacy and Security Doctoral Training Program". (Supporting Faculty)
 - NSF. IIS-0936440 "REU to CPA-SEL: Betters Tools for Software Understanding", 05/01/2009, \$16,000, Research Experiences for Undergraduates.
 - NSF. IIS-0936407 "REU to CreativeIT: Pilot: Exploratory Programming for Interactive Behaviors: Unleashing Interaction Designers' Creativity", 05/01/2009, \$16,000, Research Experiences for Undergraduates.
 - NIH/NINR. R01NR010711, "Phase III Trial of PocketPATH: A Computerized Intervention to Promote Self-Care," 07/01/2008-04/30/2013. \$2,076,909. (PI is Prof. Annette DeVito Dabbs at Univ. Pitt)
 - NSF. CCF-0811610, "CPA-SEL: Betters Tools for Software Understanding", 7/1/08-6/30/11, \$300,000.
 - NSF. IIS-0757511 "CreativeIT: Pilot: Exploratory Programming for Interactive Behaviors: Unleashing Interaction Designers' Creativity", 05/01/2008-04/30/2010, \$200,000.
 - EEC-0540865, "Quality of Life Technology Engineering Research Center". 5/17/2006-5/31/2011. \$15,000,000.
 - Microsoft Research, Support for the Pebbles Project. 2007: \$10,939 equipment; 2006: \$80,000 cash and \$2,500 equipment; 2004: \$4,000 equipment; 2003: \$8,500 equipment; 2002: \$80,000 cash; 2001: \$70,000 cash; 2000: \$70,000 cash; 1999: \$150,000 cash; 1998: \$100,000 cash + \$2,600 equipment.
 - IBM. 2006 Eclipse Innovation Award. "Program Understanding and Debugging in Eclipse". \$27,000
 - NSF. EEC-0540865, "Quality of Life Technology Engineering Research Center". 5/17/2006-5/31/2011. \$15,000,000.
 - NSF. IIS-0534349. "Automatically Generating Consistent User Interfaces for Multiple Appliances." 12/1/05-11/30/08. \$412,000.
 - NACME/Philip D. Reed Undergraduate Fellowship. (The National Action Council for Minorities in Engineering). \$2,000 for Ivan Gonzalez, Brad Myers. 2005-2006.
 - General Motors. "Using Handheld Devices for Information and Control in Vehicles." 2006: \$87,365. 2005: \$83,678. 2004: \$83,678. 2003: \$83,678; Summer, 2002: \$5000.
 - Synaptics, Inc. 2004. Equipment: \$600.
 - Nokia Research Center, Finland. 2004. Equipment: \$2000.
 - AT Sciences, LLC. 2004. Equipment: \$1300.
 - SMART Technologies, Inc.. 2000: Equipment: \$2998. 2004: Equipment: \$50.
 - Lutron, Inc. "Remote Control of UPnP Devices". 2003. \$2000.
 - Lantronix, Inc. "Remote Control of UPnP Devices". 2003. \$1144.
 - NSF. IIS-0329090. "Lowering the Barriers to Successful Programming." Brad Myers and Randy Pausch. 2003-2007. \$1,200,000
 - NSF ITR CCR-0324770: "Collaborative Research: Dependable End-User Software". 2003-2007. Margaret M. Burnett, Gregg Rothermel, Brad Myers, Martin Erwig, Margaret L. Niess, Sebastian Elbaum, Mary Beth Rosson, Mary Shaw, Susan Wiedenbeck. \$2,640,000. CMU Portion: \$324,000.
 - IBM Canada, Ltd. "Update Pebbles for new Palms." 2003. Equipment: USD \$1,792.09
 - DARPA. "Evolutionary Development of Self-Aware Learning Agents." Dan Siewiorek, Jaime Carbonell, Tom Mitchell, Manuela Veloso, Brad Myers, Randy Pausch, Alex Waibel, Eric Nyberg, Bill Scherlis, Raj Reddy, Howard Wactlar. \$38,765,940. 2003 - 2007.
 - NEC Foundation of America. "Handhelds as Assistive Technologies for People with Muscular Disabilities." 2003. \$50,000.
 - NSF. UA-0308065. "Using Handhelds to Help People with Motor Impairments." 2003-2007. \$475,232.
 - NSF. EIA-0205301. "ITR: Collaborative Research: Putting a Face on Cognitive Tutors: Bringing Active Inquiry into Active Problem Solving." Albert Corbett, Kenneth Koedinger, Scott Stevens, and Brad Myers. \$2,414,648. 10/01/02 - 09/30/07.
 - Mitsubishi Electric Research Laboratory. "Remote Control of HAVi Appliances in Pebbles." Mitsubishi WS-65909 65" Integrated HDTV Diamond Series television and Mitsubishi HS-HD2000U High Definition Digital VCR. 2002. \$6,500 plus \$1,500 for VividLogic HAVi toolkit.
 - NSF. IIS-0223945. "Research Experiences for Undergraduates (REU) Supplement to IIS-0117658: Making it Easier to Interact with Technology Through Handheld Personal Universal Controllers." Summer, 2002. \$6000.

- NSF. IIS-0117658. "Making it Easier to Interact with Technology Through Handheld Personal Universal Controllers." 2001-2004. \$505,867.
- TDK Systems Europe, LTD. 2001. Six BlueTooth modules, \$700.
- Pittsburgh Digital Greenhouse, Brad Myers and Jodi Forlizzi, "Using Mobile Devices as Universal Personal Controllers," 2000-2002, \$167,000.
- Hewlett Packard, "Ubiquitous Computing at Carnegie Mellon; Delivering Innovative Classroom Applications Using Handheld Devices", Diana Bajzek, Tracy Futhey, Kim Jordan, Dr. Brad Myers, Dr. Dan Sieworick, Dr. Randy Weinberg, Dr. David Yaron. 2000. Equipment: 330 Jornada computers, \$304,170.
- Lucent Technologies, "Ubiquitous Computing at Carnegie Mellon; Delivering Innovative Classroom Applications Using Handheld Devices", Diana Bajzek, Tracy Futhey, Kim Jordan, Dr. Brad Myers, Dr. Dan Sieworick, Dr. Randy Weinberg, Dr. David Yaron. 2000. Equipment: about 300 Wavelan wireless network PCMCIA cards for the HP Jornada's, approx. \$45,000.
- Symbol Technologies, Inc., Support for the Pebbles Project. 2000. Equipment: \$7300.
- CMU Small Undergraduate Research Grant (SURG). For work by Geoffrey Washburn: "A Graphics Library for Introductory Programming." Fall, 1999: \$425. Summer, 1999: \$3000.
- Palm Computing, Inc. Using Handhelds for the Handicapped, 2001: Equipment: \$516. Studying Multiple People using Pebbles Software and Hand-helds in Education, 2000: Equipment: \$4,788; 1999: Equipment: \$3,690.
- IBM. Studying Multiple People using Pebbles Software. 1999. Equipment: \$3,725.
- DARPA. "Adding Features to Pebbles," 1999. \$40,000.
- NSF, etc. (Interagency program). Digital Library Initiative-2, IIS-9817527. 1999-2002. "An Intelligent Authoring Tool for Non-Programmers Using the Informedia Video Library," Brad Myers, Scott Stevens and Al Corbett. \$450,000.
- USENIX Association's Scholastic Committee grant for "Lightweight Structured Text Editing," (work of PhD student Rob Miller). 2000-2001: \$19,800. 1999-2000: \$18,300. 1998-1999: \$17,700.
- NSF. IRI-9900452. 1999-2002. "A More Natural Programming Environment for Children," Brad Myers and Al Corbett. \$400,000.
- DARPA under the Command Post of the Future program. "High Bandwidth Command and Control." With Bill Scherlis, Alex Waibel, Randy Pausch and Jie Yang. 1998-2002. \$2,706,000.
- Dupont Corporation. Educational Aid Program. 1998. \$10,000.
- NSF. IRI-9319969. 1994-1997. Demonstrational Interfaces for Visualization and End-User Programming. \$240,000.
- ARPA. Contract N66001-94-C-6037, ARPA Order No. B326. 1994 - 1998. Creating User Interface Software. \$1,733,469.
- Siemens Corporation. Unrestricted. 1995: \$20,000. 1990: \$20,000.
- NEC. Unrestricted. 1993: \$5000. 1989: \$15,000.
- NSF. IRI-9020089. 1991-1993 (two years). Using Demonstration in Interfaces. \$269,061.
- DARPA. Contract F33615-90-C-1465, ARPA Order No. 7597. 1990-1993. Creating Graphical Interfaces. \$1,704,000.
- General Electric. 1990-1991. Postscript and Visualization in Garnet. \$20,000.
- Apple Computer, Inc. 1990. Garnet on a Macintosh. \$7000.
- Apple Computer, Inc. 1989-1991. Demonstrational Interfaces. Equipment \$18,978, cash \$50,000.

Publications:

Books:

1. Allen Cypher, Daniel C. Halbert, David Kurlander, Henry Lieberman, David Maulsby, Brad A. Myers and Alan Turransky, eds. *Watch What I Do: Programming by Demonstration*. Cambridge, MA: The MIT Press, 1993. [web page](#).
2. Brad A. Myers, ed. *Languages for Developing User Interfaces*. Boston: Jones and Bartlett, 1992. ISBN:

0867204508. <http://www.cs.cmu.edu/~bam/langbook.html>

3. Brad A. Myers. *Creating User Interfaces by Demonstration*. Boston, MA: Academic Press, May 1988. ISBN: 0125123051.

Book Sections:

(Does not include reprints of conference articles listed below.)

4. Brad A. Myers, "User Interfaces for Handheld Devices," sidebar in *The UX Book: Process and Guidelines for Ensuring a Quality User Experience*, by: Rex Hartson & Pardha S. Pyla. Waltham, MA: Elsevier/Morgan Kaufmann, 2012. pp. 690-1.
5. Brad A. Myers, "Legal and Intellectual Property Issues," sidebar in *The UX Book: Process and Guidelines for Ensuring a Quality User Experience*, by: Rex Hartson & Pardha S. Pyla. Waltham, MA: Elsevier/Morgan Kaufmann, 2012. pp. 851-2.
6. Chris Scaffidi, Brad Myers, and Mary Shaw. "Trial By Water: Creating Hurricane Katrina 'Person Locator' Web Sites" *Leadership at a Distance: Research in Technologically-Supported Work S*. Weisband, ed, Lawrence Erlbaum, 2008. pp. 209-222.
7. Jacob O. Wobbrock and Brad A. Myers, "Adding gestural text entry to input devices for people with motor impairments", Chapter 14 in J. Lazar (ed.), *Universal Usability*. New York: John Wiley & Sons. 2007. pp. 421-456.
8. John F. Pane and Brad A. Myers, "More Natural Programming Languages and Environments," in *End User Development*, vol. 9 of the Human-Computer Interaction Series, Henry Lieberman, Fabio Paterno, and Volker Wulf, eds. Dordrecht, The Netherlands: Springer, 2006, pp. 31-50.
9. Brad A. Myers. "Graphical User Interface Programming," chapter 48 of *Computer Science Handbook -- Second Edition*. Allen B. Tucker, editor in chief. Boca Raton, FL: Chapman & Hall/CRC Press, Inc., 2004. pp. 48-1 - 48-29. [pdf](#)
10. Brad Myers, Scott E. Hudson, and Randy Pausch, "Past, Present and Future of User Interface Software Tools," in John M. Carroll, ed. *HCI In the New Millennium*. New York: ACM Press, Addison-Wesley, 2001. pp. 213-233. [ACM.ref](#)
11. Brad Myers and Richard McDaniel. "Demonstrational Interfaces: Sometimes You Need a Little Intelligence; Sometimes You Need a Lot." *Your Wish is My Command*. Henry Lieberman, Ed. San Francisco: Morgan Kaufmann, 2001. pp. 45-60.
12. David Wolber and Brad Myers. "Stimulus-Response PBD: Demonstrating When as Well as What." *Your Wish is My Command*. Henry Lieberman, Ed. San Francisco: Morgan Kaufmann, 2001. pp. 321-344.
13. Brad A. Myers, Rich McDaniel, and Rob Miller, "The Amulet Prototype-Instance Framework," in *Domain-Specific Application Frameworks*, edited by Mohamed Fayad and Ralph E. Johnson. New York: John Wiley & Sons, 2000. ISBN# 0-471-332801. pp. 529-546. <http://www.cs.cmu.edu/~amulet/papers/amulettappframe.pdf>
14. Brad A. Myers, Rich McDaniel, Rob Miller, Brad Vander Zanden, Dario Giuse, David Kosbie and Andrew Mickish, "The Prototype-Instance Object Systems in Amulet and Garnet," *Prototype Based Programming: Concepts, Languages and Applications*, James Noble, Antero Taivalsaari and Ivan Moore, eds. Singapore: Springer-Verlag, 1999. pp. 141-176. ISBN 981-4021-25-3. [pdf](#)
15. Brad A. Myers. "User Interface Management Systems," *Wiley Encyclopedia of Electrical and Electronics Engineering, Volume 23*. John G. Webster, editor. New York: John Wiley & Sons, 1999. pp. 42-58.
16. Brad A. Myers. "Interface Software Technology," chapter 72 of *CRC Handbook of Computer Science and Engineering*. Allen B. Tucker, editor in chief. Boca Raton, FL: CRC Press, Inc., 1997. pp. 1571-1595.
17. Brad A. Myers. "Program Visualization," *Encyclopedia of Software Engineering*. John J. Marciniak, ed. New York: John Wiley & Sons, Inc., 1994. pp. 877-892.
18. Brad A. Myers. "User Interface Software," *Encyclopedia of Computer Science and Technology*. Allen Kent and James G. Williams, editors. Vol. 33, no. 18. New York: Marcel Dekker, Inc., 1995. pp. 371-405. and *Encyclopedia of Microcomputers*. Allen Kent and James G. Williams, editors. New York: Marcel Dekker, Inc., 1996. pp. 223-257.
19. Brad A. Myers. "State of the Art in User Interface Software Tools," *Advances in Human-Computer Interaction, Volume 4*. Edited by H. Rex Hartson and Deborah Hix. Norwood, NJ: Ablex Publishing, 1993. pp. 110-150. Reprinted in: R.Baecker, J.Grudin, W.Buxton, and S. Greenberg, eds. *Readings in Human-Computer Interaction: Toward the Year 2000*. Second Edition. San Francisco: Morgan Kaufmann

- Publishers, Inc., 1995. pp. 344-356.
20. Brad A. Myers. "Peridot: Creating User Interfaces by Demonstration," *Watch What I Do: Programming by Demonstration*, Allen Cypher, et. al., eds. Cambridge, MA: The MIT Press, 1993. pp. 125-153. [html \(without pictures\)](#)
 21. Brad A. Myers. "Garnet: Uses of Demonstrational Techniques," *Watch What I Do: Programming by Demonstration*, Allen Cypher, et. al., eds. Cambridge, MA: The MIT Press, 1993. pp. 219-236. [html](#)
 22. Brad A. Myers. "Tourmaline: Text Formatting by Demonstration," *Watch What I Do: Programming by Demonstration*, Allen Cypher, et. al., eds. Cambridge, MA: The MIT Press, 1993. pp. 309-321. [html](#)
 23. Francesmary Modugno and Brad A. Myers. "Graphical Representation and Feedback in a PBD System," *Watch What I Do: Programming by Demonstration*, Allen Cypher, et. al., eds. Cambridge, MA: The MIT Press, 1993. pp. 415-422. [html](#)
 24. David S. Kosbie and Brad A. Myers. "PBD Invocation Techniques: A Review and Proposal," *Watch What I Do: Programming by Demonstration*, Allen Cypher, et. al., eds. Cambridge, MA: The MIT Press, 1993. pp. 423-431. [html](#)
 25. David S. Kosbie and Brad A. Myers. "A System-Wide Macro Facility Based on Aggregate Events: A Proposal," *Watch What I Do: Programming by Demonstration*, Allen Cypher, et. al., eds. Cambridge, MA: The MIT Press, 1993. pp. 433-444. [html](#)
 26. Brad A. Myers. "Demonstrational Interfaces: A Step Beyond Direct Manipulation," *Watch What I Do: Programming by Demonstration*, Allen Cypher, et. al., eds. Cambridge, MA: The MIT Press, 1993. pp. 485-512. [html](#)
 27. Brad A. Myers and David Maulsby. "Glossary," *Watch What I Do: Programming by Demonstration*, Allen Cypher, et. al., eds. Cambridge, MA: The MIT Press, 1993. pp. 593-603. [html](#)
 28. Brad A. Myers. "Introduction," *Languages for Developing User Interfaces*. Boston: Jones and Bartlett, 1992. pp. 1-20.
 29. Brad A. Myers. "Ideas from Garnet for Future User Interface Programming Languages," *Languages for Developing User Interfaces*. Boston: Jones and Bartlett, 1992. pp. 147-157.
 30. Brad A. Myers, David Canfield Smith, and Bruce Horn. "Report of the 'End-User Programming' Working Group," *Languages for Developing User Interfaces*. Boston: Jones and Bartlett, 1992. pp. 343-366.
 31. Brad A. Myers. "Demonstrational Interfaces: A Step Beyond Direct Manipulation," *People and Computers VI*. Dan Diaper and Nick Hammond, eds. Cambridge, England: Cambridge University Press, 1991. pp. 11-30.
 32. Brad A. Myers. "Using AI Techniques to Create User Interfaces by Example," in Joseph W. Sullivan, ed, *Intelligent User Interfaces*. Reading, MA: Addison-Wesley/ACM Press, 1991. pp. 385-401.
 33. Brad A. Myers. "Issues in Window Manager Design and Implementation," ch. 6 of *Methodology of Window Management*, F. Robert A. Hopgood, et. al., eds. Berlin: Springer-Verlag, 1986. pp. 59-71. [html](#) (Also contributed to other chapters, especially pp. 181-187. [html](#))

Refereed Journal Articles:

34. Karen A. Kovach, Jill Ann Aubrecht, Alex Begey, Mary Amanda Dew, Brad Myers, Annette DeVito Dabbs. "Data Safety and Monitoring for Research Involving Remote Health Monitoring." *Telemedicine and eHealth*. Vol. 17, no. 7, Sept, 2011. pp. 574-579. [pubmed](#).
35. Andrew J. Ko, Robin Abraham, Laura Beckwith, Alan Blackwell, Margaret Burnett, Martin Erwig, Joseph Lawrance, Henry Lieberman, Brad Myers, Mary Beth Rosson, Gregg Rothermel, Chris Scaffidi, Mary Shaw, Susan Wiedenbeck. "The State of the Art in End-User Software Engineering", *ACM Computing Surveys*. 43(3), Article 21, (April 2011). 44 pages. [ACM DL](#) and [local pdf](#)
36. Andrew J. Ko and Brad A. Myers. "Extracting and Answering Why and Why Not Questions about Java Program Output" *ACM Transactions on Software Engineering and Methodology (TOSEM)*. 20(2), Article 4, (August 2010). 36 pages. [ACM DL](#) and [local pdf](#)
37. Chris Scaffidi, Chris Bogart, Margaret Burnett, Allen Cypher, Brad Myers, Mary Shaw, "Using Traits of Web Macro Scripts to Predict Reuse", *Journal of Visual Languages and Computing*, vol. 21, no. 5, 2010. pp. 277-291. [pdf](#)
38. Jeffrey Nichols and Brad A. Myers. "Creating a Lightweight User Interface Description Language: An Overview and Analysis of the Personal Universal Controller Project". *ACM Transactions on Computer-Human Interaction*, special issue User Interface Description Languages for Next Generation User

- Interfaces. Vol. 16, no. 4, (November 2009). pp. 1-37. [ACM DL](#)
39. Andrew Faulring, Ken Mohnkern, Aaron Steinfeld, and Brad A. Myers, "Design and Evaluation of User Interfaces for the RADAR Learning Personal Assistant". *AI Magazine*. AAAI Press. 30(4). Winter, 2009. 74-84. [on-line](#) or [local.pdf](#)
 40. Brad A. Myers, Sae Young Jeong, Yingyu Xie, Jack Beaton, Jeff Stylos, Ralf Ehret, Jan Karstens, Arkin Efeoglu, Daniela K. Busse. "Studying the Documentation of an API for Enterprise Service-Oriented Architecture". *The Journal of Organizational and End User Computing, JOEUC*, a publication of the Information Resources Management Association, IGI Publishing. Special Issue on End-User Development. vol. 22, no. 1, Jan-Mar, 2010. pp. 23-51. [IGI global](#), DOI: 10.4018/joeuc.2010101903.
 41. Jacob O Wobbrock, Brad A Myers, Htet Htet Aung, "The Performance of Hand Postures in Front- and Back-of-Device Interaction for Mobile Computing". *International Journal of Human-Computer Studies*, Special issue on mobility and human-computer interaction. 2008. Volume 66, Issue 12, December 2008, Pages 857-875. [on-line](#) or [local.pdf](#)
 42. Christopher Scaffidi, Allen Cypher, Sebastian Elbaum, Andhy Koesnandar, Brad Myers. "Using Scenario-Based Requirements to Direct Research on Web Macro Tools". *Journal of Visual Languages and Computing*. Vol. 19, No. 4, Aug, 2008, 485-498. [pdf](#)
 43. Jacob O. Wobbrock and Brad A. Myers. "Enabling Devices, Empowering People: The Design and Evaluation of Trackball EdgeWrite," *Disability and Rehabilitation: Assistive Technologies*, special issue on Accessibility. Volume 3 Issue 1, January, 2008, pp. 35-56.
 44. Andrew J. Ko, Brad A. Myers, Michael Coblenz, and Htet Htet Aung. "An Exploratory Study of How Developers Seek, Relate, and Collect Relevant Information during Software Maintenance Tasks", *IEEE Transactions on Software Engineering*. Vol. 32, No. 12, Dec, 2006. pp. 971-987. [pdf](#)
 45. Jeffrey Nichols and Brad A. Myers, "Controlling Home and Office Appliances with Smartphones". *IEEE Pervasive Computing*, special issue on SmartPhones, Vol. 5, No. 3, July-Sept, 2006. pp. 60-67. [pdf](#)
 46. Jacob O. Wobbrock and Brad A. Myers. "Analyzing the Input Stream for Character-level Errors in Unconstrained Text Entry Evaluations." *ACM Transactions on Computer Human Interaction*. Vol. 13, no. 4, December, 2006, pp. 458 - 489. [pdf](#)
 47. Ben Shneiderman, Gerhard Fischer, Mary Czerwinski, Mitch Resnick, Brad Myers, "Creativity Support Tools: Report from a U.S. National Science Foundation Sponsored Workshop". *International Journal of Human-Computer Interaction*, 20(2), 2006, pp. 61-77.
 48. Andrew J. Ko and Brad A. Myers, "A Framework and Methodology for Studying the Causes of Software Errors in Programming Systems". *Journal of Visual Languages and Computing*, Volume 16, no. 1. Feb, 2005. pp. 41-84. [pdf](#)
 49. Brad A. Myers, Jeffrey Nichols, Jacob O. Wobbrock, and Robert C. Miller. "Taking Handheld Devices to the Next Level." *IEEE Computer*. December, 2004. vol. 37, no. 12. pp. 36-43. [pdf](#) or [html](#)
 50. Jacob O. Wobbrock, Htet Htet Aung, Brad A. Myers, and Edmund F. LoPresti. "Integrated Text Entry from Power Wheelchairs." *Behaviour and Information Technology*. Vol. 24, no. 3. May-June 2005. pp. 187-203. [BIT online](#)
 51. Bradley T. Vander Zanden, Richard Halterman, Brad A. Myers, Rob Miller, Pedro Szekely, Dario A. Giuse, David Kosbie, and Rich McDaniel. "Lessons learned from programmers' experiences with one-way constraints," *Software: Practice and Experience*. John Wiley & Sons, Inc. 2005. vol. 35, no. 13. pp. 1275-1298. [DOI](#)
 52. Brad A. Myers. "Using Handhelds for Wireless Remote Control of PCs and Appliances," *Interacting with Computers*, Elsevier Science Journals. 2005. Volume 17, Issue 3, May 2005, Pages 251-264. [DOIref](#) or [local.pdf](#)
 53. Brad A. Myers, John F. Pane and Andy Ko, "Natural Programming Languages and Environments". *Communications of the ACM*. (special issue on End-User Development). Sept, 2004, vol. 47, no. 9. pp. 47-52. [pdf](#)
 54. Brad A. Myers. "Using Hand-Held Devices and PCs Together," *Communications of the ACM*. Volume 44, Issue 11. November, 2001. pp. 34 - 41. <http://www.cs.cmu.edu/~pebbles/papers/pebblescacm.pdf>
 55. Bradley T. Vander Zanden, Richard Halterman, Brad A. Myers, Rich McDaniel, Rob Miller, Pedro Szekely, Dario Giuse, and David Kosbie. "Lessons Learned About One-Way, Dataflow Constraints in the Garnet and Amulet Graphical Toolkits." *ACM Transactions on Programming Languages and Systems (TOPLAS)*. Vol. 23, No. 6, November 2001, Pages 776-796. [PDF](#)
 56. James Landay and Brad Myers. "Sketching Interfaces: Toward More Human Interface Design", *IEEE*

- Computer*, March, 2001. Vol. 34, No. 3. pp. 56-64. <http://www.cs.cmu.edu/~garnet/silk-ieee-published.pdf>
57. Bernhard Suhm, Brad Myers and Alex Waibel, "Multi-Modal Error Correction for Speech User Interfaces," *ACM Transactions on Computer Human Interaction*, vol. 8, no. 1, March 2001, pp. 60-98.
 58. John F. Pane, Chotirat "Ann" Ratanamahatana, and Brad A. Myers, "Studying the Language and Structure in Non-Programmers' Solutions to Programming Problems", *International Journal of Human-Computer Studies (IJHCS)*. Special Issue on Empirical Studies of Programmers, vol. 54, no. 2, February 2001, pp. 237-264.
<http://www.cs.cmu.edu/~pane/IJHCS.html>
 59. Brad A. Myers. "Using Multiple Devices Simultaneously for Display and Control." *IEEE Personal Communications* special issue on "Smart Spaces and Environments." vol. 7, no. 5, Oct. 2000. pp. 62-65.
[pdf](#).
 60. Brad Myers, Richard McDaniel and David Wolber. "Programming by example: Intelligence in Demonstrational Interfaces," *Communications of the ACM*. March, 2000. vol. 43, no. 3. pp. 82-89. [pdf](#)
 61. Brad Myers, Scott E. Hudson, and Randy Pausch, "Past, Present and Future of User Interface Software Tools," *ACM Transactions on Computer Human Interaction*. March, 2000. Vol. 7, no. 1. pp. 3-28. [ACM ref](#) or [ACM pdf](#) or [draft pdf](#).
 62. Brad A. Myers, Rich McDaniel, Rob Miller, Brad Vander Zanden, Dario Giuse, David Kosbie, and Andrew Mickish, "Our Experience with Prototype-Instance Object-Oriented Programming in Amulet and Garnet." *Interfaces*, Issue No. 39 (August 1998), ISSN: 1351-119X. A Publication of the [British HCI Group](#). pp. 4-9.
 63. Brad A. Myers. "A Brief History of Human Computer Interaction Technology." *ACM interactions*. Vol. 5, no. 2, March, 1998. pp. 44-54. [pdf](#)
 64. Francesmary Modugno, Albert T. Corbett, and Brad A. Myers. "Graphical Representation of Programs in a Demonstrational Visual Shell -- An Empirical Evaluation," *ACM Transactions on Computer-Human Interaction*. Sept, 1997, vol. 4, no. 3. pp. 276-308.
 65. Francesmary Modugno and Brad A. Myers. "Visual Programming in a Visual Shell -- A Unified Approach," *Journal of Visual Languages and Computing*, Volume 8, no. 5/6. Oct/Dec, 1997. pp. 491-522.
 66. Brad A. Myers, Richard G. McDaniel, Robert C. Miller, Alan Ferrency, Andrew Faulring, Bruce D. Kyle, Andrew Mickish, Alex Klimovitski, and Patrick Doane. "The Amulet Environment: New Models for Effective User Interface Software Development", *IEEE Transactions on Software Engineering*, Vol. 23, no. 6. June, 1997. pp. 347-365. [IEEE pdf](#) or [tech report postscript](#) or [abstract only](#)
 67. Brad A. Myers, Jim Hollan, Isabel Cruz, et. al.. "Strategic Directions in Human Computer Interaction," *ACM Computing Surveys*, vol. 28, no. 4, December, 1996. pp. 794-809.
<http://www.cs.cmu.edu/~bam/nsfworkshop/hcireport.html>
 68. Brad A. Myers. "User Interface Software Technology," *ACM Computing Surveys*. Vol. 28, no. 1, March, 1996. pp. 189-191. <http://www.cs.cmu.edu/~amulet/papers/uims handbook uidesign.ps>
 69. Brad Vander Zanden and Brad A. Myers. "Demonstrational and Constraint-Based Techniques for Pictorially Specifying Application Objects and Behaviors," *ACM Transactions on Computer-Human Interaction*. Vol. 2, no. 4, Dec, 1995. pp. 308-356.
 70. Brad A. Myers. "User Interface Software Tools," *ACM Transactions on Computer-Human Interaction*. vol. 2, no. 1, March, 1995. pp. 64-103. [ACM DL](#), [pdf](#), [tech report \(ps\)](#)
 71. Brad Vander Zanden, Brad A. Myers, Dario Giuse and Pedro Szekely. "Integrating Pointer Variables into One-Way Constraint Models," *ACM Transactions on Computer-Human Interaction*. vol. 1, no. 2, June, 1994. pp. 161-213. [ACM Ref](#)
 72. Brad A. Myers. "Challenges of HCI Design and Implementation," *ACM Interactions*. vol. 1, no. 1. January, 1994. pp. 73-83. <http://reports-archive.adm.cs.cmu.edu/anon/1993/CMU-CS-93-183.ps>
 73. Robert J.K. Jacob, John J. Leggett, Brad A. Myers, and Randy Pausch. "Interaction Styles and Input/Output Devices," *Behaviour and Information Technology*. March-April, 1993. vol. 12, no. 2. pp. 69-79.
 74. Dan R. Olsen, Jr., James D. Foley, Scott E. Hudson, James Miller, and Brad Myers. "Research Directions for User Interface Software Tools," *Behaviour and Information Technology*. March-April, 1993. vol. 12, no. 2. pp. 80-97.
 75. Brad A. Myers. "Demonstrational Interfaces: A Step Beyond Direct Manipulation," *IEEE Computer*.

- August, 1992. vol. 25, no. 8. pp. 61-73.
76. Brad A. Myers and Brad Vander Zanden. "Environment for Rapid Creation of Interactive Design Tools," *The Visual Computer; International Journal of Computer Graphics*. vol. 8, no. 2, February, 1992. pp. 94-116.
 77. Brad A. Myers. "A New Model for Handling Input," *ACM Transactions on Information Systems*. vol. 8, no. 3. July, 1990. pp. 289-320.
 78. Brad A. Myers, Dario A. Giuse, Roger B. Dannenberg, Brad Vander Zanden, David S. Kosbie, Ed Pervin, Andrew Mickish, and Philippe Marchal. "Garnet: Comprehensive Support for Graphical, Highly-Interactive User Interfaces," *IEEE Computer*. vol. 23, no. 11. November, 1990. pp. 71-85. Translated into Japanese and reprinted in *Nikkei Electronics*, No. 522, March 18, 1991, pp. 187-205. Also reprinted in: R.Baecker, J.Grudin, W.Buxton, and S. Greenberg, eds. *Readings in Human-Computer Interaction: Toward the Year 2000*. Second Edition. San Francisco: Morgan Kaufmann Publishers, Inc., 1995. pp. 357-372. [pdf](#)
 79. Brad Vander Zanden and Brad A. Myers. "A Constraints Primer," *IEEE Computer*. vol. 23, no. 11. November, 1990. pp. 74-75.
 80. Brad A. Myers. "Creating User Interfaces Using Programming-by-Example, Visual Programming, and Constraints," *ACM Transactions on Programming Languages and Systems*. vol. 12, no. 2, April, 1990. pp. 143-177.
 81. Brad A. Myers. "Taxonomies of Visual Programming and Program Visualization," *Journal of Visual Languages and Computing*. vol. 1, no. 1. March, 1990. pp. 97-123. (A draft version is available in [pdf format](#))
 82. Brad A. Myers. "User Interface Tools: Introduction and Survey," *IEEE Software*, vol. 6, no. 1, Jan, 1989. pp. 15-23. Reprinted in *Milestones in Software Evolution*, Paul W. Oman and Ted G. Lewis, ed. Los Alamitos, CA: IEEE Computer Society Press, 1990. pp. 261-269.
 83. Brad A. Myers. "A Taxonomy of User Interfaces for Window Managers," *IEEE Computer Graphics and Applications*, vol. 8, no. 5, Sept, 1988. pp. 65-84. [IEEE DL](#) or [local pdf](#)
 84. Brad A. Myers. "Creating Interaction Techniques by Demonstration," *IEEE Computer Graphics and Applications*, vol. 7, no. 9, Sept, 1987. pp. 51-60. [pdf](#) Reprinted in *Visual Programming Environments: Paradigms and Systems*, Ephraim P. Glinert, ed. Los Alamitos, CA: IEEE Computer Society Press, 1990. pp. 378-387.
 85. John R. Dance, Tamar E. Granor, Ralph D. Hill, Scott E. Hudson, Jon Meads, Brad A. Myers, and Andrew Schulert. "The Run-time Structure of UIMS-Supported Applications," *Computer Graphics*. vol. 21, no. 2, April, 1987. pp. 97-101. Reprinted in *The Separable User Interface*, Ernest Edmonds, ed. Academic Press, 1992. pp. 213-225.
 86. Brad A. Myers. "A Complete and Efficient Implementation of Covered Windows," *IEEE Computer*. vol. 19, no. 9. Sept, 1986. pp. 57-67. [IEEE dl](#) or [local pdf](#)
 87. Brad A. Myers. "The User Interface for Sapphire," *IEEE Computer Graphics and Applications*. vol. 4, no. 12, Dec, 1984. pp. 13-23.

Major Refereed Conference Papers:

88. Stephen Oney, Brad A. Myers, Joel Brandt, "ConstraintJS: Programming Interactive Behaviors for the Web by Integrating Constraints and States", *UIST'2012: ACM Symposium on User Interface Software and Technology*, October 7-10, 2012. Cambridge, MA. pp. 229-238. [ACM DL](#) or [local pdf](#).
89. Cyrus Omar, YoungSeok Yoon, Thomas D. LaToza, Brad A. Myers, "Active Code Completion." *ICSE'2012: 34th International Conference on Software Engineering*, Zurich, Switzerland, 2-9 June 2012. pp. 859-869. [local pdf](#).
90. Kerry Chang and Brad Myers, "WebCrystal: Understanding and Reusing Examples in Web Design", *Proceedings CHI'2012: Human Factors in Computing Systems*. Austin, TX, May 5-10, 2012. pp. 3205-3214. [ACM DL](#) or [local pdf](#)
91. Thomas D. LaToza, Brad A. Myers, "Visualizing Call Graphs", *2011 IEEE Symposium on Visual Languages and Human-Centric Computing (VL/HCC'11)*, Pittsburgh, PA, Sept. 18-22, 2011. pp. 117-124. [local pdf](#).
92. Mathew Mooty, Andrew Faulring, Jeffrey Stylos and Brad Myers. "Calcite: Completing Code Completion for Constructors using Crowds," *2010 IEEE Symposium on Visual Languages and Human-Centric*

- Computing (VL/HCC'10)*, Leganés-Madrid, Spain, 21-25 September 2010. pp. 15-22. [IEEE DL](#) or [local pdf](#)
93. Daniel S. Eisenberg, Jeffrey Stylos, Andrew Faulring, Brad A. Myers. "Using Association Metrics to Help Users Navigate API Documentation," *2010 IEEE Symposium on Visual Languages and Human-Centric Computing (VL/HCC'10)*, Leganés-Madrid, Spain, 21-25 September 2010. pp. 23-30. [IEEE DL](#) or [local pdf](#)
94. Thomas D. LaToza and Brad Myers. "Developers Ask Reachability Questions", *ICSE'2010: 32nd International Conference on Software Engineering*, Cape Town, South Africa, 2-8 May 2010. pp. 185-194. [pdf](#)
95. Kursat Ozenc, Miso Kim, John Zimmerman, Stephen Oney, and Brad Myers. "How to Support Designers in Getting Hold of the Immaterial Material of Software". *Proceedings CHI'2010: Human Factors in Computing Systems*. Atlanta, GA, April 10-15, 2010. pp. 2513-2522. [local pdf](#)
96. Daniel S. Eisenberg, Jeffrey Stylos, and Brad A. Myers, "Apatite: A New Interface for Exploring APIs" *Proceedings CHI'2010: Human Factors in Computing Systems*. Atlanta, GA, April 10-15, 2010. pp. 1331-1334. [local pdf](#) and [local movie](#)
97. Andrew Faulring, Brad Myers, Ken Mohnkern, Bradley Schmerl, Aaron Steinfeld, John Zimmerman, Asim Smailagic, Jeffery Hansen, and Daniel Siewiorek. "Agent-Assisted Task Management that Reduces Email Overload," *Proceedings of the International Conference on Intelligent User Interfaces (IUI 2010)*. Hong Kong, China. Feb 7-10, 2010. pp. 61-70. **Honorable Mention Award in the Best Paper Contest.** [local pdf](#) and [ACM DL](#)
98. Stephen Oney and Brad Myers. "FireCrystal: Understanding Interactive Behaviors in Dynamic Web Pages". *2009 IEEE Symposium on Visual Languages and Human-Centric Computing, VL/HCC'09*. Sept. 20-24, 2009. Corvallis, Oregon. pp. 105-108. [IEEE DL pdf](#) or [local pdf](#)
99. Chris Scaffidi, Chris Bogart, Margaret Burnett, Allen Cypher, Brad Myers, Mary Shaw. "Predicting Reuse of End-User Web Macro Scripts" *IEEE Symposium on Visual Languages and Human-Centric Computing, VL/HCC'09*. Sept. 20-24, 2009. Corvallis, Oregon. pp. 93-100. [IEEE DL pdf](#) or [local pdf](#)
100. Jeffrey Stylos, Andrew Faulring, Zizhuang Yang, Brad A. Myers. "Improving API Documentation Using API Usage Information". *IEEE Symposium on Visual Languages and Human-Centric Computing, VL/HCC'09*. Sept. 20-24, 2009. Corvallis, Oregon. pp. 119-126. [IEEE DL pdf](#) or [local pdf](#)
101. Annette DeVito Dabbs, Brad A. Myers, Kenneth R. McCurry, Jacqueline Dunbar-Jacob, Robert P. Hawkins, Alex Begey, Mary Amanda Dew, "User-Centered Design and the Development of an Interactive Health Technology for Patients". *Computers In Nursing*. May/June 2009, Volume 27, Issue 3. pp 175-183. [on-line](#) and [local pdf](#)
102. DeVito Dabbs A, Dew MA, Myers B, Begey A, Hawkins R, Ren D, Dunbar-Jacob J, Oconnell E, McCurry KR. "Evaluation of a hand-held, computer-based intervention to promote early self-care behaviors after lung transplant." *Clinical Transplantation*. 2009(23): pp: 537-545. John Wiley & Sons A/S.
103. Andrew J. Ko and Brad A. Myers. "Finding Causes of Program Output with the Java Whyline", *Proceedings CHI'2009: Human Factors in Computing Systems*. Boston, MA, April 4-9, 2009. pp. 1569-1578. [pdf](#)
104. Chris Scaffidi, Brad Myers, Mary Shaw. "Intelligently Creating and Recommending Reusable Reformatting Rules". *IUI'2009: Intelligent User Interfaces Conference*, Sanibel Island, Florida, 8-11 February 2009. pp. 297-306. [pdf](#)
105. Jeffrey Stylos, Brad A. Myers. "The Implications of Method Placement on API Learnability," *Sixteenth ACM SIGSOFT Symposium on Foundations of Software Engineering (FSE 2008)*. Atlanta, GA, November 9-14, 2008. 105-112. [pdf](#) or [ACM version](#)
106. Jack Beaton, Sae Young Jeong, Yingyu Xie, Jeffrey Stylos, Brad A. Myers. "Usability Challenges for Enterprise Service-Oriented Architecture APIs," *2008 IEEE Symposium on Visual Languages and Human-Centric Computing, VL/HCC'08*. Sept 15-18, 2008, Herrsching am Ammersee, Germany. pp. 193-196. [pdf](#)
107. Brad Myers, Sunyoung Park, Yoko Nakano, Greg Mueller, Andrew Ko, "How Designers Design and Program Interactive Behaviors," *2008 IEEE Symposium on Visual Languages and Human-Centric Computing, VL/HCC'08*. Sept 15-18, 2008, Herrsching am Ammersee, Germany. pp. 177-184. [pdf](#). See also [the original survey](#).
108. Sunyoung Park, Brad Myers, Andrew Ko. "Designers' Natural Descriptions of Interactive Behaviors,"

- 2008 *IEEE Symposium on Visual Languages and Human-Centric Computing, VL/HCC'08*. Sept 15-18, 2008, Herrsching am Ammersee, Germany. pp. 185-188. [pdf](#)
109. Michael Freed, Jaime Carbonell, Geoff Gordon, Brad Myers, Dan Siewiorek, Steve Smith, Aaron Steinfeld, Anthony Tomasic. "RADAR: A Personal Assistant that Learns to Reduce Email Overload", *Twenty-Third AAAI Conference on Artificial Intelligence: AAAI-08 Integrated Intelligence Track*. Chicago, Illinois, July 13-17, 2008. pp. 1287-1293. [pdf](#)
110. Christopher Scaffidi, Brad Myers, Mary Shaw, "Topes: Reusable Abstractions for Validating Data." *ICSE'2008: 30th International Conference on Software Engineering*, Leipzig, Germany, 10 - 18 May 2008. pp. 1-10. [IEEE DL pdf](#)
111. Andrew J. Ko and Brad A. Myers, "Debugging, Reinvented: Asking and Answering Why and Why Not Questions about Program Behavior" *ICSE'2008: 30th International Conference on Software Engineering*, Leipzig, Germany, 10 - 18 May 2008. pp. 301-310. **Winner, Distinguished Paper Award.** [pdf](#)
112. Duen Horng Chau and Brad Myers. "What to Do When Search Fails: Finding Information by Association," *Proceedings CHI'2008: Human Factors in Computing Systems*. Florence, Italy, April 5-10, 2008. pp. 999-1008. [pdf](#)
113. Andrew Faulring, Ken Mohnkern, Aaron Steinfeld, Brad A. Myers, "Successful User Interfaces for Radar," *CHI'2008 workshop on Usable Artificial Intelligence*, April 5-6, 2008, Florence, Italy. [pdf](#)
114. Jeffrey Stylos and Brad Myers, "Mapping the Space of API Design Decisions," *2007 IEEE Symposium on Visual Languages and Human-Centric Computing, VL/HCC'07*. Sept 23-27, 2007, Coeur d'Alene, Idaho. pp. 50-57. [pdf](#)
115. Christopher Scaffidi, Allen Cypher, Sebastian Elbaum, Andhy Koesnandar, Brad Myers. "Scenario-Based Requirements for Web Macro Tools" *2007 IEEE Symposium on Visual Languages and Human-Centric Computing, VL/HCC'07*. Sept 23-27, 2007, Coeur d'Alene, Idaho. pp. 197-204. [pdf](#)
116. Thomas D. LaToza, David Garlan, James D. Herbsleb, Brad A. Myers, "Program comprehension as fact finding", *ESEC/FSE 2007: ACM SIGSOFT Symposium on the Foundations of Software Engineering*, Dubrovnik, Croatia, September 3-7, 2007, pp. 361-370. [pdf](#)
117. Ivan E. Gonzalez, Jacob O. Wobbrock, Duen Horng Chau, Andrew Faulring, and Brad A. Myers, "Eyes on the Road, Hands on the Wheel: Thumb-based Interaction Techniques for Input on Steering Wheels" *Graphics Interface 2007*, May 28-30, 2007, Montreal, Canada. pp. 95-102. [pdf](#)
118. Jeffrey Nichols, Duen Horng Chau, Brad A. Myers, "Demonstrating the Viability of Automatically Generated User Interfaces" *Proceedings CHI'2007: Human Factors in Computing Systems*. San Jose, CA, April 28 - May 3, 2007. pp. 1283-1292. [pdf](#)
119. Jacob O. Wobbrock, Duen Horng Chau and Brad A. Myers, "An Alternative to Push, Press, and Tap-tap-tap: Gesturing on an Isometric Joystick for Mobile Phone Text Entry" *Proceedings CHI'2007: Human Factors in Computing Systems*. San Jose, CA, April 28 - May 3, 2007. pp. 667-667. [pdf](#)
120. Brian Ellis, Jeffrey Stylos, and Brad Myers. "The Factory Pattern in API Design: A Usability Evaluation". *International Conference on Software Engineering (ICSE'2007)*. May 20-26, 2007. Minneapolis, MN. pp. 302-312. [ACM](#) or [local pdf](#)
121. Jacob O. Wobbrock and Brad A. Myers, "From Letters to Words: Efficient Stroke-based Word Completion for Trackball Text Entry", *8th International ACM SIGACCESS Conference on Computers and Accessibility, ASSETS'06*, Portland, OR, Oct. 23-25, 2006. pp. 2-9. [pdf](#)
122. Michael J. Coblenz, Andrew J. Ko and Brad A. Myers, "JASPER: An Eclipse Plug-In to Facilitate Software Maintenance Tasks", *Eclipse Technology eXchange (ETX) Workshop at OOPSLA 2006*, Portland, Oregon, October 22-23, 2006. pp. 65-69. [pdf](#) and [ACM DOI](#)
123. Jacob O. Wobbrock, Brad A. Myers, and Duen Horng Chau, "In-stroke Word Completion". *ACM Symposium on User Interface Software and Technology, UIST'06*, October 15-18, 2006, Montreux, Switzerland. pp. 333-336. [pdf](#)
124. Jeffrey Nichols, Brandon Rothrock, Duen Horng Chau, Brad A. Myers. "Huddle: Automatically Generating Interfaces for Systems of Multiple Connected Appliances" *ACM Symposium on User Interface Software and Technology, UIST'06*, October 15-18, 2006, Montreux, Switzerland. pp. 279-288. [pdf](#)
125. Andrew J. Ko, Brad A. Myers, and Duen Horng Chau, "A Linguistic Analysis of How People Describe Software Problems" *2006 IEEE Symposium on Visual Languages and Human-Centric Computing, VL/HCC'06*. Sept 4-8, 2006, Brighton, UK. pp. 127-134. [pdf](#)
126. Christopher Scaffidi, Andrew Ko, Brad Myers, Mary Shaw, "Dimensions Characterizing the Usage of Programming Features by Information Workers" *2006 IEEE Symposium on Visual Languages and*

- Human-Centric Computing, VL/HCC'06*. Sept 4-8, 2006, Brighton, UK. pp. 59-62. [pdf](#)
127. Jeffrey Stylos and Brad A. Myers. "Mica: A Programming Web-Search Aid". *2006 IEEE Symposium on Visual Languages and Human-Centric Computing, VL/HCC'06*. Sept 4-8, 2006, Brighton, UK. pp. 195-202. [pdf](#)
128. Brad Myers, David A. Weitzman, Andrew J. Ko, and Duen Horng Chau, "Answering Why and Why Not Questions in User Interfaces," *Proceedings CHI'2006: Human Factors in Computing Systems*. Montreal, Canada, April 22-27, 2006. pp. 397-406. [pdf](#) and [video](#)
129. Jacob O. Wobbrock and Brad A. Myers, "Trackball Text Entry for People with Motor Impairments," *Proceedings CHI'2006: Human Factors in Computing Systems*. Montreal, Canada, April 22-27, 2006. pp. 479-488. **Winner, CHI 2006 Best Paper Award.** [pdf](#)
130. Andrew J. Ko and Brad A. Myers, "Barista: An Implementation Framework for Enabling New Tools, Interaction Techniques and Views in Code Editors," *Proceedings CHI'2006: Human Factors in Computing Systems*. Montreal, Canada, April 22-27, 2006. pp. 387-396. [pdf](#)
131. Jeffrey Nichols, Brad A. Myers, Brandon Rothrock, "UNIFORM: Automatically Generating Consistent Remote Control User Interfaces," *Proceedings CHI'2006: Human Factors in Computing Systems*. Montreal, Canada, April 22-27, 2006. pp. 611-620. [pdf](#)
132. Jacob O. Wobbrock, Brad A. Myers and Brandon Rothrock, "Few-key Text Entry Revisited: Mnemonic Gestures on Four Keys," *Proceedings CHI'2006: Human Factors in Computing Systems*. Montreal, Canada, April 22-27, 2006. pp. 489-492. [pdf](#)
133. Andrew J. Ko and Brad A. Myers. "Citrus: A Toolkit for Simplifying the Creation of Structured Editors for Code and Data." *ACM Symposium on User Interface Software and Technology, UIST'05*, October 23-26, 2005, Seattle, WA. pp. 3-12. [pdf](#) or [ACM ref video](#)
134. Christopher Scaffidi, Mary Shaw, Brad Myers. "Estimating the Numbers of End Users and End User Programmers," 2005 IEEE Symposium on Visual Languages and Human-Centric Computing (VL/HCC'05), Dallas, Texas, USA, 20-24 September 2005. pp. 207-214. [pdf](#)
135. Andrew J. Ko, Htet Htet Aung, and Brad A. Myers. "Eliciting Design Requirements for Maintenance-Oriented IDEs: A Detailed Study of Corrective and Perfective Maintenance Tasks". *27th International Conference on Software Engineering*. St. Louis, MO. 15-21 May, 2005. pp. 126-135. **Winner, Distinguished Paper Award.** [pdf](#)
136. Jeffrey Stylos, Brad A. Myers, Andrew Faulring, "Citrine: Providing Intelligent Copy-and-Paste." *ACM Symposium on User Interface Software and Technology, UIST'04*, October 24-27, 2004, Santa Fe, NM. pp. 185-188. [pdf](#) and [video](#)
137. Jacob O. Wobbrock, Brad A. Myers, Htet Htet Aung, and Edmund F. LoPresti. "Text Entry from Power Wheelchairs: EdgeWrite for Joysticks and Touchpads." *Proceedings of the ACM SIGACCESS Conference on Computers and Accessibility (ASSETS '04)*. October 18-20, 2004. Atlanta, GA. pp. 110-117. **Winner, Best Paper Award.** [pdf](#)
138. Andrew J. Ko, Brad A. Myers, and Htet Htet Aung, "Six Learning Barriers in End-User Programming Systems." *VL/HCC'04: IEEE Symposium on Visual Languages and Human-Centric Computing*, Rome, Italy, September 26-29, 2004. pp. 199-206. [pdf](#)
139. Jacob O. Wobbrock, Brad A. Myers, and Htet Htet Aung. "Writing with a Joystick: A Comparison of Date Stamp, Selection Keyboard, and EdgeWrite," *Graphics Interface GI'2004*. Canadian Human-Computer Communications Society. May 17-19, 2004, London, Ontario, Canada. pp. 1-8. [pdf](#)
140. Andrew Jensen Ko and Brad A. Myers, "Designing the Whyline: A Debugging Interface for Asking Questions about Program Failures," *Proceedings CHI'2004: Human Factors in Computing Systems*. Vienna, Austria, April 24-29, 2004. pp. 151-158. [pdf](#)
141. Jeffrey Nichols, Brad A. Myers and Kevin Litwack. "Improving Automatic Interface Generation with Smart Templates," *ACM IUI'04*, Jan. 13-16, 2004, Madeira, Funchal, Portugal. pp. 286-288. [pdf](#)
142. Andrew J. Ko and Brad A. Myers. "Development and Evaluation of a Model of Programming Errors". 2003. *IEEE Symposium on End-User and Domain-Specific Programming (EUP'03)*, part of the *IEEE Symposia on Human-Centric Computing Languages and Environments, (HCC'03)*. October 28-31, 2003. Auckland, New Zealand. pp. 7-14. [pdf](#). Judged to be one of the two best papers.
143. Jacob O. Wobbrock, Brad A. Myers, and John Kembel. "EdgeWrite: A Stylus-Based Text Entry Method Designed for High Accuracy And Stability of Motion," *CHI Letters: ACM Symposium on User Interface Software and Technology, UIST'03*, Nov. 2-5, 2003, Vancouver, British Columbia, Canada. pp. 61-70. [pdf](#)
144. Jeffrey Nichols and Brad A. Myers. "Studying The Use of Handhelds to Control Smart Appliances".

- International Workshop on Smart Appliances and Wearable Computing. IWSAWC 2003*. In the Proceedings of the 23rd IEEE Conference on Distributed Computing Systems Workshops (*ICDCS'03*). May 19-22, 2003, Providence, Rhode Island. pp. 274-279. [pdf](#)
145. Jacob O. Wobbrock, Brad A. Myers, and Scott E. Hudson. "Exploring Edge-based Input Techniques for Handheld Text Entry". *International Workshop on Smart Appliances and Wearable Computing. IWSAWC 2003*. In the Proceedings of the 23rd IEEE Conference on Distributed Computing Systems Workshops (*ICDCS'03*). May 19-22, 2003, Providence, Rhode Island. pp. 280-282. [pdf](#)
146. Brad Myers, Robert Malkin, Michael Bett, Alex Waibel, Ben Bostwick, Robert C. Miller, Jie Yang, Matthias Denecke, Edgar Seemann, Jie Zhu, Choon Hong Peck, Dave Kong, Jeffrey Nichols, Bill Scherlis. "Flexi-modal and Multi-Machine User Interfaces", *IEEE Fourth International Conference on Multimodal Interfaces*, Pittsburgh, PA. October 14-16, 2002. pp. 343-348. [pdf](#)
147. Jeffrey Nichols, Brad Myers, Thomas K. Harris, Roni Rosenfeld, Stefanie Shriver, Michael Higgins, Joseph Hughes. "Requirements for Automatically Generating Multi-Modal Interfaces for Complex Appliances," *IEEE Fourth International Conference on Multimodal Interfaces*, Pittsburgh, PA. October 14-16, 2002. pp. 377-382. [pdf](#)
148. Jeffrey Nichols, Brad A. Myers, Michael Higgins, Joe Hughes, Thomas K. Harris, Roni Rosenfeld, Mathilde Pignol. "Generating Remote Control Interfaces for Complex Appliances." *CHI Letters: ACM Symposium on User Interface Software and Technology, UIST'02*, 27-30 Oct. 2002, Paris, France. pp. 161-170. [pdf](#)
149. Jacob O. Wobbrock, Jodi Forlizzi, Scott E. Hudson, Brad A. Myers, "WebThumb: Interaction Techniques for Small-Screen Browsers," *CHI Letters: ACM Symposium on User Interface Software and Technology, UIST'02*, 27-30 Oct. 2002, Paris, France. pp. 205-208. [pdf](#)
150. Brad A. Myers. "Mobile Devices for Control," *The Fourth Symposium on Human-Computer Interaction for Mobile Devices, Mobile HCI'02*. (Keynote speech), September 18-20, 2002, Pisa, Italy. pp. 1-8. <http://www.cs.cmu.edu/~pebbles/papers/pebblesMobileHCI2002.pdf>
151. J.F. Pane, B.A. Myers, and L.B. Miller, "Using HCI Techniques to Design a More Usable Programming System," *2002 IEEE Symposia on Human Centric Computing Languages and Environments (HCC'02)*. Arlington, VA, September 3-6, 2002. pp. 198-206. <http://www.cs.cmu.edu/~pane/handsdesign.html>
152. Juan Casares, Brad A. Myers, A. Chris Long, Rishi Bhatnagar, Scott M. Stevens, Laura Dabbish, Dan Yocum, and Albert Corbett. "Simplifying Video Editing Using Metadata." In *Proceedings of Designing Interactive Systems (DIS 2002)*, London, UK, June 2002. pp. 157-166. [Acrobat \(pdf\)](#)
153. Brad A. Myers, Jacob O. Wobbrock, Sunny Yang, Brian Yeung, Jeffrey Nichols, and Robert Miller. "Using Handhelds to Help People with Motor Impairments", *Fifth International ACM SIGCAPH Conference on Assistive Technologies; ASSETS 2002*. July 8-10, 2002. Edinburgh, Scotland. pp. 89-96. <http://www.cs.cmu.edu/~pebbles/papers/pebbleshandicapped.pdf>.
154. Robert C. Miller and Brad A. Myers, "Multiple Selections in a Smart Text Editor". *2002 International Conference on Intelligent User Interfaces: IUI'2002*. San Francisco, CA, January 13-16, 2002. pp. 103 - 110. [PDF](#)
155. Brad A. Myers, Rishi Bhatnagar, Jeffrey Nichols, Choon Hong Peck, Dave Kong, Robert Miller, and A. Chris Long. "Interacting At a Distance: Measuring the Performance of Laser Pointers and Other Devices." *Proceedings CHI'2002: Human Factors in Computing Systems*. Minneapolis, Minnesota, April 20-25, 2002. pp. 33-40. [pdf](#).
156. Robert C. Miller and Brad A. Myers. "Outlier Finding: Focusing User Attention on Possible Errors," *CHI Letters: ACM Symposium on User Interface Software and Technology, UIST'01*, November 11-14, 2001. Orlando, Florida. pp. 81-90. Available as [HTML](#) and [PDF](#)
157. Brad A. Myers, Choon Hong Peck, Jeffrey Nichols, Dave Kong, and Robert Miller, "Interacting At a Distance Using Semantic Snarfing," *UbiComp'2001: Ubiquitous Computing*, G. Abowd, B. Brummit, and S. Shafer, ed. ACM. Springer. Sept 30 - Oct 2, 2001, Atlanta, Georgia. pp. 305-314. [pdf](#).
158. Brad A. Myers, Juan P. Casares, Scott Stevens, Laura Dabbish, Dan Yocum, Albert Corbett, "A Multi-View Intelligent Editor for Digital Video Libraries.", *The First ACM+IEEE Joint Conference on Digital Libraries, JCDL'01*, June 24-28, 2001, Roanoke, VA. pp. 106-115. [PDF](#) or [Postscript](#)
159. Robert C. Miller and Brad A. Myers. "Interactive Simultaneous Editing of Multiple Text Regions." *USENIX 2001 Annual Technical Conference*, Boston, MA, June 2001. pp. 161-174. [html](#) or [pdf](#)
160. John Pane and Brad Myers, "Tabular and Textual Methods for Selecting Objects from a Group," *IEEE Symposium on Visual Languages, VL'2000*, Seattle, Washington, September 10-14, 2000. pp. 157-164.

- <http://www.cs.cmu.edu/~pane/study3.html>
161. Brad A. Myers, Robert C. Miller, Benjamin Bostwick, and Carl Evankovich, "Extending the Windows Desktop Interface With Connected Handheld Computers," *4th USENIX Windows Systems Symposium*, August 3-4, 2000, Seattle, WA. pp. 79-88. <http://www.cs.cmu.edu/~pebbles/papers/pebblesone.ps> or <http://www.cs.cmu.edu/~pebbles/papers/pebblesone.pdf>.
 162. Robert C. Miller and Brad A. Myers. "Integrating a Command Shell into a Web Browser." *USENIX 2000 Annual Technical Conference*, San Diego, CA, June 2000. pp 171-182. Tied for "Best Student Paper" award. [html](#), [pdf](#)
 163. Brad Myers, Kin Pou ("Leo") Lie and Bo-Chieh ("Jerry") Yang, "Two-Handed Input Using a PDA and a Mouse", *Proceedings CHI'2000: Human Factors in Computing Systems*. April 1-6, 2000. The Hague, The Netherlands. pp. 41-48. <http://www.cs.cmu.edu/~pebbles/papers/pebbles2handexp.ps> or <http://www.cs.cmu.edu/~pebbles/papers/pebbles2handexp.pdf>.
 164. Robert C. Miller and Brad A. Myers, "Synchronizing Clipboards of Multiple Computers," *CHI Letters: ACM Symposium on User Interface Software and Technology, UIST'99*, vol. 1, no. 1. November 7-10, 1999. Asheville, NC. pp. 65-66. [pdf](#).
 165. Robert C. Miller, Brad A. Myers, "Lightweight Structured Text Processing." *1999 Usenix Annual Technical Conference*, June 6-11, 1999, Monterey, California. pp 131-144. Winner of "Outstanding Paper Award." [html](#) or [pdf](#)
 166. Richard G. McDaniel and Brad A. Myers, "Getting More Out Of Programming-By-Demonstration." *Proceedings CHI'99: Human Factors in Computing Systems*. Pittsburgh, PA, May 15-20, 1999. pp. 442-449. [pdf](#) and [video](#)
 167. Bernhard Suhm, Brad Myers and Alex Waibel, "Model-based and Empirical Evaluation of Multimodal Interactive Error Correction." *Proceedings CHI'99: Human Factors in Computing Systems*. Pittsburgh, PA, May 15-20, 1999. pp. 584-591. <http://www.cs.cmu.edu/~bsuhm/papers/chi99.ps>
 168. Brad A. Myers, Herb Stiel, and Robert Gargiulo. "Collaboration Using Multiple PDAs Connected to a PC," *Proceedings CSCW'98: ACM Conference on Computer-Supported Cooperative Work*, November 14-18, 1998, Seattle, WA. pp. 285-294. <http://www.cs.cmu.edu/~pebbles/papers/pebblesCSCW.ps> <http://www.cs.cmu.edu/~pebbles/papers/pebblesCSCW.pdf>
 169. Brad A. Myers. "Scripting Graphical Applications by Demonstration," *Proceedings CHI'98: Human Factors in Computing Systems*. Los Angeles, CA, April 18-23, 1998. pp. 534-541. [pdf](#) [video](#). (Topaz)
 170. Richard G. McDaniel and Brad A. Myers. "Building Applications Using Only Demonstration," *IUI'98: 1998 International Conference On Intelligent User Interfaces*, January 6-9, 1998, San Francisco, CA. pp. 109-116. [pdf](#) and [video](#)
 171. Brad A. Myers, Robert C. Miller, Rich McDaniel, and Alan Ferrency, "Easily Adding Animations to Interfaces Using Constraints." *ACM Symposium on User Interface Software and Technology, UIST'96*, November 6-8, 1996. Seattle, WA. pp. 119-128. [ACM ref](#) [postscript](#)
 172. Bernhard Suhm, Brad Myers and Alex Waibel, "Interactive Recovery from Speech Recognition Errors in Speech User Interfaces," *Proceedings of the International Conference on Spoken Language Processing, ICSLP'96*, Philadelphia PA, Oct. 1996, Vol.2, pp. 861-864. <http://www.cs.cmu.edu/~bsuhm/papers/icslp96.ps>
 173. Brad A. Myers and David Kosbie. "Reusable Hierarchical Command Objects," *Proceedings CHI'96: Human Factors in Computing Systems*. Vancouver, BC, Canada. April 13-18, 1996. pp. 260-267. http://www.acm.org/sigs/sigchi/chi96/proceedings/papers/Myers/bam_com.htm <http://www.cs.cmu.edu/~amulet/papers/commandsCHI.html> and <ftp://ftp.cs.cmu.edu/afs/cs.cmu.edu/project/amulet/www/papers/commandsCHI.ps>
 174. Francesmary Modugno, Albert T. Corbett and Brad A. Myers. "Evaluating Program Representation in a Demonstrational Visual Shell." *Experimental Studies of Programmers Sixth Workshop*. Jan. 5-7, 1996. Alexandria, VA. Wayne Gray and Deborah Boehm-Davis, editors. Ablex Publishing corporation, Norwood, NJ. pp 131-146. [Abstract](#) [Compressed Postscript](#)
 175. James Landay and Brad A. Myers. "Interactive Sketching for the Early Stages of User Interface Design," *Proceedings CHI'95: Human Factors in Computing Systems*. Denver, CO. May, 1995. pp. 43-50. ftp://ftp.cs.cmu.edu/afs/cs.cmu.edu/user/landay/pub/www/research/publications/SILK_CHI/SILK_CHI.ps
 176. Francesmary Modugno and Brad A. Myers. "A State-Based Visual Language for a Demonstrational Visual Shell," *1994 IEEE Workshop on Visual Languages*. St. Louis, MO. pp. 304-311. [Abstract](#) [Compressed Postscript](#)

177. Francesmary Modugno, T.R.G. Green and Brad A. Myers. "Visual Programming in a Visual Domain: A Case Study of Cognitive Dimension," *Human-Computer Interaction '94, People and Computers*. Glasgow, Scotland, August, 1994. pp. 91-108. [Abstract](#) or [pdf](#)
178. Francesmary Modugno and Brad A. Myers. "Exploring Graphical Feedback in a Demonstrational Visual Shell," *The 1994 East-West International Conference on Human-Computer Interaction (EWHCI'94)*. St. Petersburg, Russia, August, 1994. pp. 262-272. An updated version appears in *Lecture Notes in Computer Science 876*. Brad Blumenthal, Juri Gornostaev and Claus Unger, Editors. Springer-Verlag, 1994. [Abstract](#) [Compressed Postscript](#)
179. David S. Kosbie and Brad A. Myers, "Extending Programming By Demonstration With Hierarchical Event Histories," *The 1994 East-West International Conference on Human-Computer Interaction*. St. Petersburg, Russia, August, 1994. pp. 147-157. <http://reports-archive.adm.cs.cmu.edu/anon/1994/CMU-CS-94-156.ps> [Abstract only](#)
180. Brad A. Myers, Jade Goldstein, and Matthew A. Goldberg. "Creating Charts by Demonstration," *Proceedings CHI'94: Human Factors in Computing Systems*. Boston, MA, Apr. 24-28, 1994. pp. 106-111. [pdf](#) and [video](#)
181. Brad A. Myers, Richard G. McDaniel, and David S. Kosbie. "Marquise: Creating Complete User Interfaces by Demonstration," *Proceedings INTERCHI'93: Human Factors in Computing Systems*. Amsterdam, The Netherlands, April 24-29, 1993. pp. 293-300. [pdf](#) or [video](#)
182. Osamu Hashimoto and Brad A. Myers. "Graphical Styles For Building User Interfaces by Demonstration," *ACM Symposium on User Interface Software and Technology: UIST'92*, Monterey, CA, Nov. 16-18, 1992. pp. 117-124. [pdf](#) or [video \(54 sec. no sound\)](#)
183. Brad A. Myers, Dario A. Giuse, and Brad Vander Zanden. "Declarative Programming in a Prototype-Instance System: Object-Oriented Programming Without Writing Methods," *Proceedings OOPSLA'92: ACM Conference on Object-Oriented Programming Systems, Languages, and Applications*. October 18-22, 1992. Vancouver, BC, Canada. *SIGPLAN Notices*, vol. 27, no. 10. pp. 184-200.
184. Brad A. Myers and Mary Beth Rosson. "Survey on User Interface Programming," *Proceedings SIGCHI'92: Human Factors in Computing Systems*. Monterey, CA, May 3-7, 1992. 195-202. [ps](#) or [pdf](#)
185. Brad A. Myers. "Separating Application Code from Toolkits: Eliminating the Spaghetti of Call-Backs," *ACM Symposium on User Interface Software and Technology: UIST'91*, Hilton Head, SC, Nov. 11-13, 1991. pp. 211-220. [pdf](#) or [video](#)
186. Brad Vander Zanden, Brad A. Myers, Dario Giuse and Pedro Szekely. "The Importance of Pointer Variables in Constraint Models," *ACM Symposium on User Interface Software and Technology: UIST'91*, Hilton Head, SC, Nov. 11-13, 1991. pp. 155-164.
187. Keiji Kojima and Brad A. Myers. "Parsing Graphic Function Sequences," *1991 IEEE Workshop on Visual Languages*. Kobe, Japan, October 9-11, 1991. pp. 111-117.
188. Brad A. Myers. "Text Formatting by Demonstration," *Proceedings SIGCHI'91: Human Factors in Computing Systems*. New Orleans, LA. April 28-May 2, 1991. pp. 251-256.
189. Brad A. Myers. "Graphical Techniques in a Spreadsheet for Specifying User Interfaces," *Proceedings SIGCHI'91: Human Factors in Computing Systems*. New Orleans, LA. April 28-May 2, 1991. pp. 243-249. [ACM ref](#) or [video](#)
190. Brad Vander Zanden and Brad A. Myers. "The Lapidary Graphical Interface Design Tool," *Proceedings SIGCHI'91: Human Factors in Computing Systems*. New Orleans, LA. April 28-May 2, 1991. pp. 465-466. [video excerpt](#)
191. Brad A. Myers. "Invisible Programming," *1990 IEEE Workshop on Visual Languages*. Skokie, Ill, October 4-6, 1990. pp. 203-208.
192. Brad Vander Zanden and Brad A. Myers, "Automatic, Look-and-Feel Independent Dialog Creation for Graphical User Interfaces," *Proceedings SIGCHI'90: Human Factors in Computing Systems*. Seattle, WA, April 1-5, 1990. pp. 27-34. [ACM ref](#)
193. Brad A. Myers, Brad Vander Zanden, and Roger B. Dannenberg. "Creating Graphical Interactive Application Objects by Demonstration," *ACM Symposium on User Interface Software and Technology: UIST'89*, Williamsburg, VA, Nov. 13-15, 1989. pp. 95-104. [ACM ref](#)
194. Brad A. Myers. "Encapsulating Interactive Behaviors," *Proceedings SIGCHI'89: Human Factors in Computing Systems*. Austin, Texas, April 30 - May 4, 1989, pp. 319-324. [ACM ref](#)
195. Brad A. Myers, Ravinder Chandhok, and Atul Sareen. "Automatic Data Visualization for Novice Pascal Programmers," *1988 IEEE Workshop on Visual Languages*. Pittsburgh, PA, October 10-12, 1988, pp.

- 192-198. [pdf](#).
196. Pedro Szekely and Brad Myers. "A User Interface Toolkit Based on Graphical Objects and Constraints," *OOPSLA '88: Conference on Object-Oriented Programming: Systems, Languages and Applications*, San Diego, CA, September 25-30, 1988. *Sigplan Notices*, vol. 23, no. 11, November, 1988. pp. 36 - 45.
197. Brad A. Myers. "Creating Dynamic Interaction Techniques by Demonstration," *Proceedings SIGCHI+GI '87: Human Factors in Computing Systems*. Toronto, Ont. Apr. 5-9, 1987. pp. 271-278. [pdf](#)
198. Brad A. Myers and William Buxton. "Creating Highly Interactive and Graphical User Interfaces by Demonstration," *Computer Graphics: SIGGRAPH '86 Conference Proceedings*. vol. 20, no. 4, August 18-22, 1986. Dallas, Texas. pp. 249-258. Reprinted in R.M. Baecker and W.A.S. Buxton, eds, *Readings in Human-Computer Interaction*, Los Altos, CA: Morgan Kaufmann Publishers, 1987. pp. 595-604. [pdf](#)
199. Brad A. Myers. "Visual Programming, Programming by Example, and Program Visualization; A Taxonomy," *Proceedings SIGCHI '86: Human Factors in Computing Systems*. Boston, MA. April 13-17, 1986. pp. 59-66. Reprinted in *Visual Programming Environments: Paradigms and Systems*, Ephraim P. Glinert, ed. Los Alamitos, CA: IEEE Computer Society Press, 1990. pp. 33-40. [pdf](#)
200. William Buxton and Brad Myers. "A Study in Two-Handed Input," *Proceedings SIGCHI '86: Human Factors in Computing Systems*. Boston, MA. April 13-17, 1986. pp. 321-326. [html](#) and [video](#).
201. Brad A. Myers. "The Importance of Percent-Done Progress Indicators for Computer-Human Interfaces," *Proceedings SIGCHI '85: Human Factors in Computing Systems*. San Francisco, CA. Apr. 14-18, 1985. pp. 11-17. Reprinted as *Datapro Report* no. AS40-300-301, Dec, 1986. [pdf](#)
202. Brad A. Myers. "Incense: A System for Displaying Data Structures," *Computer Graphics: SIGGRAPH '83 Conference Proceedings*. vol. 17, no. 3, July, 1983. Detroit, MI. pp. 115-125. [pdf](#)

Minor Refereed Conference Papers:

203. Philippe Palanque, Fabio Paterno, Jeffrey Nichols, Nuno Jardim Nunes, Brad A. Myers, "The Role of Engineering Work in CHI," CHI'2013 Special Interest Group Meeting. *Extended Abstracts, CHI'2013*, Paris, France, April 27-May 2, 2013. To appear.
204. YoungSeok Yoon and Brad A. Myers, "An Exploratory Study of Backtracking Strategies Used by Developers," *Cooperative and Human Aspects of Software Engineering (CHASE)*, An ICSE 2012 Workshop. Zurich, Switzerland, June 2, 2012. pp. 138-144. [pdf](#)
205. Andrew Faulring, Brad A. Myers, Yaad Oren, Keren Rotenberg. "A Case Study of Using HCI Methods to Improve Tools for Programmers," *Cooperative and Human Aspects of Software Engineering (CHASE)*, An ICSE 2012 Workshop. Zurich, Switzerland, June 2, 2012. pp. 37-39. [pdf](#)
206. Chris Scaffidi, Joel Brandt, Margaret Burnett, Andrew Dove, Brad Myers. "SIG: End-User Programming" CHI'2012 Special Interest Group Meeting. *Extended Abstracts, CHI'2012*, Austin, TX, May 5-10, 2012. pp. 1193-1196.
207. YoungSeok Yoon and Brad A. Myers, "Capturing and Analyzing Low-Level Events from the Code Editor", *PLATEAU 2011: Evaluation and Usability of Programming Languages and Tools*, workshop at the Onward! 2011 and Splash 2011 conferences, Portland, Oregon, October 24, 2011. [On-line pdf](#) or [local pdf](#).
208. Thomas D. LaToza and Brad A. Myers, "Designing Useful Tools for Developers", *PLATEAU 2011: Evaluation and Usability of Programming Languages and Tools*, workshop at the Onward! 2011 and Splash 2011 conferences, Portland, Oregon, October 24, 2011. [On-line pdf](#) or [local pdf](#).
209. Cyrus Omar, YoungSeok Yoon, Thomas D. LaToza, Brad A. Myers, "Active Code Completion," poster at *2011 IEEE Symposium on Visual Languages and Human-Centric Computing (VL/HCC'11)*, Pittsburgh, PA, Sept. 18-22, 2011. pp. 261-262. [local pdf](#).
210. Stephen Oney, John Barton, Brad Myers, Tessa Lau, Jeff Nichols. "Playbook: Revision Control and Comparison for Interactive Mockups", *IS-EUD'2011: Third International Symposium on End-User Development*, June 7-10, 2011. Torre Canne (Brindisi), Italy. Springer-Verlag, Berlin Heidelberg. *Lecture Notes in Computer Science*, 2011, Volume 6654/2011, pp. 295-300 DOI: 10.1007/978-3-642-21530-8_29. [springerlink](#) or [local pdf](#)
211. Thomas D. LaToza and Brad A. Myers. "Hard-to-Answer Questions about Code," *Proceedings of the Second Workshop on Evaluation and Usability of Programming Languages and Tools (PLATEAU'2010)* at SPLASH/Onward! 2010, October 18, 2010, Reno, NV. [pdf](#)
212. Thomas D. LaToza, Brad A. Myers. "Searching Across Paths", *SUITE'10: 2nd International Workshop on*

- Search-Driven Development - Users, Infrastructure, Tools & Evaluation*, An ICSE 2010 Workshop. May 2, 2010. Cape Town, South Africa. pp. 185-194. [pdf](#)
213. Thomas D. LaToza, Brad A. Myers. "On the Importance of Understanding the Strategies that Developers Use", *Cooperative and Human Aspects of Software Engineering (CHASE)*, An ICSE 2010 Workshop. May 2, 2010. Cape Town, South Africa. pp. 72-75. [pdf](#)
214. Brad A. Myers, Margaret M. Burnett, Andrew J. Ko, Mary Beth Rosson, Christopher Scaffidi, and Susan Wiedenbeck. "End User Software Engineering: CHI'2010 Special Interest Group Meeting". *Extended Abstracts, CHI'2010*, Atlanta, GA, April 10-15, 2010. pp. 3189-3192. [pdf](#)
215. Bass, Len; Lewis, Grace; Smith, Dennis; Myers, Brad; "SEEUP 2009: Workshop on software engineering foundations for end-user programming", *ICSE-Companion: 31st International Conference on Software Engineering*, Companion Volume, Vancouver, Canada. 16-24 May, 2009 p. 486. [pdf](#)
216. Jeffrey Stylos, Brad A. Myers, Zizhuang Yang. "Jadeite: Improving API Documentation Using Usage Information" *Extended Abstracts, CHI'2009*, (Work in Progress Poster). Boston, MA, April 4-9, 2009. pp. 4429-4434. [pdf](#)
217. John M. Daughtry, Jeffrey Stylos, Umer Farooq, Brad A. Myers. "API Usability: CHI'2009 Special Interest Group Meeting". *Extended Abstracts, CHI'2009*, Boston, MA, April 4-9, 2009. pp. 2771-2774. [pdf](#)
218. Brad A. Myers, Margaret M. Burnett, Susan Wiedenbeck, Mary Beth Rosson, Andrew J. Ko. "End User Software Engineering: CHI'2009 Special Interest Group Meeting". *Extended Abstracts, CHI'2009*, Boston, MA, April 4-9, 2009. pp. 2731-2734. [pdf](#)
219. Stephen Oney, Brad Myers, and John Zimmerman. "Visions for Euclase: Ideas for Supporting Creativity through Better Prototyping of Behaviors". *ACM CHI 2009 Workshop on Computational Creativity Support*. Saturday, April 4th, 2009, Boston, MA. [pdf](#)
220. Brad A. Myers and Andrew J. Ko, "The Past, Present and Future of Programming in HCI". *Human-Computer Interaction Consortium (HCIC'09)*, Winter Park, CO. February 4th - 8th, 2009. 2 pages. [pdf](#)
221. Christopher Scaffidi, Brad Myers, Mary Shaw, "Fast, Accurate Creation of Data Validation Formats by End-User Developers", *Second International Symposium on End User Development (IS-EUD'2009)*, March 2-4, 2009. Siegen, Germany. Springer-Verlag, LNCS 5435. pp. 242-261.
222. Sae Young Jeong, Yingyu Xie, Jack Beaton, Brad A. Myers, Jeff Stylos, Ralf Ehret, Jan Karstens, Arkin Efeoglu, Daniela K. Busse, "Improving Documentation for eSOA APIs Through User Studies", *Second International Symposium on End User Development (IS-EUD'2009)*, March 2-4, 2009. Siegen, Germany. Springer-Verlag, LNCS 5435, pp. 86-105. [pdf](#)
223. Andrew Faulring, Brad Myers, and Aaron Steinfeld, "Success of an Agent-Assisted System that Reduces Email Overload," *Proceedings of the Workshop on Users' Preferences Regarding Intelligent User Interfaces: Differences Among Users and Changes Over Time at the International Conference on Intelligent User Interfaces, (IUI 2009)*. Sanibel Island, Florida, USA. February 8, 2009. pp. 297-306. [pdf](#)
224. Michael Freed, Jaime Carbonell, Geoff Gordon, Jordan Hayes, Brad Myers, Daniel Siewiorek, Stephen Smith, Aaron Steinfeld and Anthony Tomasic. "RADAR: A Personal Assistant that Learns to Reduce Email Overload", *AAAI 2008 Workshop on Enhanced Messaging* at AAAI 2008, July 13, 2008, Chicago, IL. pp. 15-21.
225. Annette DeVito Dabbs, Mary Amanda Dew, Brad A. Myers, Alex Begey, Robert P. Hawkins, Jacqueline Dunbar-Jacob, Kenneth R. McCurry. "Methods for Involving Patients in the Development of Patient-Centered Health Informatics Technologies". Podium session presented at the *Council for the Advancement of Nursing Science. State of the Science Congress in Nursing Research*. Washington DC. 2008.
226. Chris Scaffidi, Chris Bogart, Margaret Burnett, Allen Cypher, Brad Myers, Mary Shaw. "Characterizing Reusability of End-User Web Macro Scripts". *Intl Workshop on Recommendation Systems for Software Engineering (RSSE'08)*, co-located with ACM SIGSOFT'08 / FSE 16, Atlanta, Georgia, 10 Nov 2008
227. Andrew Faulring, Brad Myers, Ken Mohnkern and Michael Freed. "A Demonstration of the RADAR Personal Assistant". Demonstration at: *Association for the Advancement of Artificial Intelligence*, July 13-18, 2008, Chicago, Ill. pp. 1976-1977. [pdf](#)
228. Jack Beaton, Brad A. Myers, Jeffrey Stylos, Sae Young (Sophie) Jeong, Yingyu (Clare) Xie. "Usability Evaluation for Enterprise SOA APIs" *2nd International Workshop on Systems Development in SOA Environments, (SDSOA 2008)*, Co-located with ICSE 2008, Leipzig, Germany. May 12, 2008. pp. 29-34. [pdf](#)
229. Brad A. Myers, Andrew Ko, Sun Young Park, Jeffrey Stylos, Thomas D. LaToza, Jack Beaton, "More

- Natural End-User Software Engineering", *Fourth Workshop on End-User Software Engineering, (WEUSE II)*, Co-located with ICSE 2008, Leipzig, Germany. May 12, 2008. pp. 30-34. [pdf](#)
230. Chris Scaffidi, Allen Cypher, Sebastian Elbaum, Andhy Koesnandar, James Lin, Brad Myers, Mary Shaw. "Using Topes to Validate and Reformat Data in End-User Programming Tools", *Fourth Workshop on End-User Software Engineering, (WEUSE IV)*, Co-located with ICSE 2008, Leipzig, Germany. May 12, 2008. pp. 11-15.
231. Andrew Ko and Brad Myers. "Source-Level Debugging with the Whyline". *Cooperative and Human Aspects of Software Engineering (CHASE)*, An ICSE 2008 Workshop. May 13, 2008, Leipzig, Germany, pp. 69-72. [pdf](#)
232. Duen Horng Chau, Brad Myers, and Andrew Faulring, "Feldspar: A System for Finding Information by Association," *CHI 2008 Workshop on Personal Information Management: PIM 2008*, April 5-6, 2008, Florence, Italy. [pdf](#)
233. Caitlin Kelleher, Brad A. Myers, Daniel P. Siewiorek, Dennis Cosgrove, Jeffrey S. Pierce, Matt Conway, Don Marinelli. "Special Session in Honor of Randy Pausch", *Extended Abstracts, CHI'2008*, Florence, Italy, April 5-10, 2008. pp. 3997-4001. [pdf](#)
234. Anker Helms Jørgensen, Brad A. Myers, "User Interface History: An Initial Seed", Special Interest Group meeting, *Extended Abstracts, CHI'2008*, Florence, Italy, April 5-10, 2008. pp. 2415-2418. [pdf](#)
235. Joerg Beringer, Gerhard Fisher, Piero Mussio, Brad Myers, Fabio Paternò, Boris de Ruyter. "The Next Challenge: from Easy-to-Use to Easy-to-Develop, Are You Ready?" *Extended Abstracts, CHI'2008*, Florence, Italy, April 5-10, 2008. pp. 2257-2260. [pdf](#)
236. Brad A. Myers, Margaret M. Burnett, Mary Beth Rosson, Andrew J. Ko, Alan Blackwell. "End User Software Engineering: CHI'2008 Special Interest Group Meeting" *Extended Abstracts, CHI'2008*, Florence, Italy, April 5-10, 2008. pp. 2371-2374. [pdf](#)
237. Christopher Scaffidi, Brad Myers, Mary Shaw, "Toped: Enabling End-User Programmers to Validate Data". *Extended Abstracts, CHI'2008*. Florence, Italy, April 5-10, 2008. pp. 3519-3524. [pdf](#)
238. Christopher Scaffidi, Brad Myers, Mary Shaw, "Tool Support for Data Validation by End-User Programmers", formal demo at *ICSE'2008: 30th International Conference on Software Engineering*, Leipzig, Germany, 10 - 18 May 2008. pp. 867-870. [IEEE DL pdf](#) or [local pdf](#)
239. DeVito Dabbs, A.J., Dew, M.A., Myers, B., Hawkins, R., Ren, D., Begey, A. & McCurry, K.R. "Randomized controlled trial of Pocket PATH: Personal assistant for tracking health on early self-care and HRQoL after Lung Transplant." (Abstract). *American Journal of Respiratory & Critical Care Medicine*. 177,7, 2008. A 508.
240. A. DeVito Dabbs, M.A. Dew, B.A. Myers, R.P. Hawkins, D. Ren, A. Begey, R. Zomak, K.L. Lo Coco, K.R. McCurry. "A Randomized Controlled Pilot Trial of PocketPATH on Early Self-Care Behaviors and HRQoL After Lung Transplant," Abstact in Proceedings of *ISHLT: The International Society for Heart & Lung Transplantation*, April 9-12, 2008, Boston, MA. Appears as:
A. DeVito Dabbs, M.A. Dew, B.A. Myers, R.P. Hawkins, D. Ren, A. Begey, R. Zomak, K.L. Lo Coco, K.R. McCurry. (Abstract). "A Randomized Controlled Trial of Pocket PATH Versus Standard Care on Self-Care Behaviors after Lung Transplant." *The Journal of Heart and Lung Transplantation*, 27(2), Supplement 1; 2008; S209. **Winner, Best Research Award, Non-Physician Category**
241. Brad A. Myers, Margaret M. Burnett, Susan Wiedenbeck, and Andrew J. Ko, "End User Software Engineering: CHI'2007 Special Interest Group Meeting," *Extended Abstracts CHI'2007*. San Jose, CA, April 28 - May 3, 2007. pp. 2125-2128.
242. Christopher Scaffidi, Brad Myers, Mary Shaw, "Challenges, Motivations, and Success Factors in the Creation of Hurricane Katrina 'Person Locator' Web Sites". *18th annual Psychology of Programming Workshop: PPIG'06*, Sept 7-8, 2006, Brighton, UK. [pdf](#)
243. De Vito Dabbs AJ, Dew MA, Myers B, Mc Curry R. "PocketPATH: Providing Patients with Pocket PCs to Promote After Transplant Healthd," (abstract) *Pennsylvania Thoracic Society 2006 Annual Scientific Sessions*, Pittsburgh PA, 2006.
244. Andrew J. Ko, Brad A. Myers, Michael J. Coblenz, and Jeffrey Stylos, "End-User Programming Productivity Tools", *The Next Step: From End-User Programming to End-User Software Engineering (WEUSE II)* at CHI'2006, Montreal, Canada, April 23, 2006. [pdf](#).
245. Chris Scaffidi, Mary Shaw, Brad Myers, "Games Programs Play: Obstacles to Data Reuse" *The Next Step: From End-User Programming to End-User Software Engineering (WEUSE II)* at CHI'2006, Montreal, Canada, April 23, 2006. [pdf](#)

246. Margaret M. Burnett, Brad Myers, Mary Beth Rosson, Susan Wiedenbeck, "The Next Step: From End-User Programming to End-User Software Engineering" *Extended Abstracts, CHI'2006*. Montreal, Canada, April 22-27, 2006. pp. 1699-1702. [pdf](#).
247. Brad A. Myers, Andrew J. Ko, Margaret M. Burnett, "Invited Research Overview: End-User Programming." *Extended Abstracts, CHI'2006*. Montreal, Canada, April 22-27, 2006. pp. 75-80. [pdf](#). See also the talk slides as a [color pdf](#) or a [black-and-white pdf](#)
248. Andrew Faulring and Brad A. Myers. "Availability Bars for Calendar Scheduling." *Extended Abstracts, CHI'2006*. Montreal, Canada, April 22-27, 2006. pp. 760-765. [pdf](#)
249. Duen Horng Chau, Jacob O. Wobbrock, Brad A. Myers, Brandon Rothrock. "Integrating Isometric Joysticks into Mobile Phones for Text Entry". *Extended Abstracts, CHI'2006*. Montreal, Canada, April 22-27, 2006. pp. 640-645. [pdf](#)
250. Brandon Rothrock, Brad A. Myers, Sophie H. Wang. "Unified Associative Information Storage and Retrieval". *Extended Abstracts, CHI'2006*. Montreal, Canada, April 22-27, 2006. pp. 1271-1276. [pdf](#)
251. Annette DeVito Dabbs, Mary Amanda Dew, Kenneth R. McCurry, and Brad A. Myers, "Designing a Consumer-Centric Technology-based Intervention to Promote Self-care after Lung Transplant", *The 18th Annual Scientific Sessions of the Eastern Nursing Research Society, New Momentum for Nursing Research: Multidisciplinary Alliances*, Cherry Hill, NJ, April 20-22, 2006. [abstract](#)
252. Ivan E. Gonzalez, Jake Wobbrock, and Brad A. Myers. "Text Entry for Automobiles", *ACM 2005 Richard Tapia Celebration of Diversity in Computing Conference*, Albuquerque, NM, October 19-22, 2005. (Poster presentation, Abstract only).
253. Jacob O. Wobbrock and Brad A. Myers. "Gestural text entry on multiple devices." Demonstration Abstract. *Proceedings of the ACM SIGACCESS Conference on Computers and Accessibility (ASSETS '05)*. Baltimore, Maryland (October 9-12, 2005). pp. 184-185. [pdf](#)
254. Michael J. Coblenz, Andrew J. Ko, and Brad A. Myers, "Using Objects of Measurement to Detect Spreadsheet Errors," *2005 IEEE Symposium on Visual Languages and Human-Centric Computing (VL/HCC'05)*, Dallas, Texas, USA, 20-24 September 2005. pp. 314-316. [pdf](#) or [IEEE ref](#)
255. Brad Myers and Jacob Wobbrock. "Text Input to Handheld Devices for People with Physical Disabilities." 11th International Conference on Human-Computer Interaction ([HCI Interactional 2005](#)). July 22-27, 2005. Las Vegas, NV. vol. 4, pp. 1962-1970. [pdf](#)
256. Jacob O. Wobbrock and Brad A. Myers. "EdgeWrite: A New Text Entry Technique Designed for Stability." *Proceedings of the 28th Annual Conference of the Rehabilitation Engineering and Assistive Technology Society of North America (RESNA'05)*. Atlanta, Georgia (June 23-27, 2005). [pdf](#)
257. Jacob O. Wobbrock and Brad A. Myers. "Accessible Handheld And Desktop Text Entry For People With Motor Impairments," *2005 NISH National Training & Achievement Conference*, New Orleans, May 22-24, 2005. First place Winner, National Scholar Award for Workplace Innovation & Design. [pdf](#)
258. Andrew J. Ko and Brad A. Myers, "Human Factors Affecting Dependability in End-User Programming," *1st Workshop on End-User Software Engineering (WEUSE 2005)* at ICSE 05, Saint Louis, MO, May 21st 2005. pp. 62-65.
259. Christopher Scaffidi, Mary Shaw, and Brad A. Myers, "An Approach for Categorizing End User Programmers to Guide Software Engineering Research." *1st Workshop on End-User Software Engineering (WEUSE 2005)* at ICSE 05, Saint Louis, MO, May 21st 2005. pp. 1-5. [pdf](#)
260. Brad A. Myers and Andy Ko, "More Natural and Open User Interface Tools," *Workshop on the Future of User Interface Design Tools*, Workshop #17 at ACM CHI'2005.
261. Andrew Faulring and Brad A. Myers, "Enabling Rich Human-Agent Interaction for a Calendar Scheduling Agent" (Interactive Poster). *Extended Abstracts CHI'2005: Human Factors in Computing Systems*. Portland, OR, April 2-7, 2005. pp. 1367-1370. [pdf](#). [ACM ref](#)
262. Brad A. Myers, Margaret Burnett and Mary Beth Rosson, "End Users Creating Effective Software." (Special Interest Group). *Extended Abstracts CHI'2005: Human Factors in Computing Systems*. Portland, OR, April 2-7, 2005. pp. 2047-2048. [pdf](#). [ACM ref](#)
263. Jacob O. Wobbrock, Htet Htet Aung, Brandon Rothrock and Brad A. Myers. "Maximizing the Guessability of Symbolic Input" (Short Talk). *Extended Abstracts CHI'2005: Human Factors in Computing Systems*. Portland, OR, April 2-7, 2005. pp. 1869-1872. [pdf](#). [ACM ref](#)
264. Andrew J. Ko, Htet Htet Aung, and Brad A. Myers. "Design Requirements for More Flexible Structured Editors from a Study of Programmers' Text Editing." (Short Talk). *Extended Abstracts CHI'2005: Human Factors in Computing Systems*. Portland, OR, April 2-7, 2005. pp. 1557-1560. [pdf](#). [ACM ref](#)

265. Jeffrey Nichols and Brad A. Myers, "Generating Consistent Interfaces for Appliances," in the *Second Workshop on Multi-User and Ubiquitous User Interfaces (MU3I) at Intelligent User Interfaces IUI'05*. January 9, 2005. San Diego, CA. pp. 9-10. [pdf](#)
266. De Vito Dabbs AJ, McCurry KR & Myers BA. "Designing and Testing Prototypes for Technology- Based Interventions; PocketPath: Using Pocket PCs to Promote After Transplant Health," (abstract) *Proceedings 2004 State of the Science Congress: Nursing Science: Working Toward a Healthier Nation: State of the Science*. CD-ROM: Washington D.C., September, 2004.
267. Jeffrey Nichols, Brad A. Myers, Kevin Litwack, Michael Higgins, Joseph Hughes, Thomas K. Harris. "Describing Appliance User Interfaces Abstractly with XML," in *Workshop on Developing User Interfaces with XML: Advances on User Interface Description Languages*, Satellite Workshop at Advanced Visual Interfaces 2004. 25 May, 2004, Gallipoli, Italy. pp, 9-16. [pdf](#)
268. Brad A. Myers and Margaret Burnett, "End-Users Creating Effective Software." *Extended Abstract CHI'2004: Human Factors in Computing Systems*. (Special Interest Group Meeting Abstract). Vienna, Austria, April 24-29, 2004. pp. 1592-1593. [pdf](#)
269. Jacob O. Wobbrock, Brad A. Myers, and Htet Htet Aung. "Joystick Text Entry Using Date Stamp, Selection Keyboard, and EdgeWrite." *Extended Abstracts CHI'2004: Human Factors in Computing Systems*. (Poster Abstract). Vienna, Austria, April 24-29, 2004. p. 1550. [pdf](#)
270. Jeffrey Nichols and Brad A. Myers, "Automatically Generating Interfaces for Multi-Device Environments" *UbiComp 2003 Workshop on Multi-Device Interfaces for Ubiquitous Peripheral Interaction*. October 12, 2003. Seattle, WA. [html](#).
271. Brad Myers and Andrew Ko. "Studying Development and Debugging To Help Create a Better Programming Environment". *CHI 2003 Workshop on Perspectives in End User Development*. April 6, 2003. pp. 65-68. [pdf](#)
272. A. Chris Long, Juan Casares, Brad A. Myers, Rishi Bhatnagar, Scott M. Stevens, Laura Dabbish, Dan Yocum, and Albert Corbett. "SILVER: Simplifying Video Editing With Metadata," *Extended Abstract CHI'2003: Human Factors in Computing Systems*. (Demonstration Abstract). Fort Lauderdale, Florida, April 5-10, 2003. pp. 628-629. [pdf](#)
273. Jeffrey Nichols, Brad A. Myers, Michael Higgins, Joseph Hughes, Thomas K. Harris, Roni Rosenfeld, Kevin Litwack. "Personal Universal Controllers: Controlling Complex Appliances With GUIs and Speech," *Extended Abstract CHI'2003: Human Factors in Computing Systems*. (Demonstration Abstract). Fort Lauderdale, Florida, April 5-10, 2003. pp. 624-625. [pdf](#)
274. Brad A. Myers, Jeffrey Nichols, Jacob O. Wobbrock, Kevin Litwack, Michael Higgins, Joe Hughes, Thomas K. Harris, Roni Rosenfeld, Mathilde Pignol. "Handheld Devices for Control". *Human-Computer Interaction Consortium (HCIC'2003)*, Winter Park, CO, Feb 5-9, 2003. [pdf](#)
275. J.F. Pane and B.A. Myers, "The Impact of Human-Centered Features on the Usability of a Programming System for Children." *Extended Abstract CHI'2002: Human Factors in Computing Systems*. (Interactive Poster Abstract). Minneapolis, Minnesota, April 20-25, 2002. pp. 684-685.
276. Juan Casares, A. Chris Long, Brad A. Myers, Scott M. Stevens, Albert Corbett, "Simplifying Video Editing with Silver." *Extended Abstract CHI'2002: Human Factors in Computing Systems*. (Interactive Poster Abstract). Minneapolis, Minnesota, April 20-25, 2002. pp. 672-673. [PDF](#)
277. Robert C. Miller and Brad A. Myers. "LAPIS: Smart Editing With Text Structure." *Extended Abstract CHI'2002: Human Factors in Computing Systems*. (Demonstration Abstract). Minneapolis, Minnesota, April 20-25, 2002. pp. 496-497.
278. Brad A. Myers, Jeff Nichols, Rob Miller. "User Interfaces that Span Hand-Held and Fixed Devices" Workshop on Distributed and Disappearing User Interfaces in Ubiquitous Computing at CHI'2001, Seattle, WA. Albrecht Schmidt, Peter Ljungstrand, and Anind Dey, editors. University of Karlsruhe Faculty of Information Technical Report 2001-6. ISSN 1432-7864. <http://www.cs.cmu.edu/~pebbles/papers/chi2001workshop4.html>
279. Jeffrey Nichols, Brad A. Myers, Rob Miller. "Personal Interfaces in Ubiquitous Environments". Workshop on Building the Ubiquitous Computing User Experience at CHI'2001, Seattle, WA. <http://www.cs.cmu.edu/~pebbles/papers/chi2001workshop10.html>
280. Brad A. Myers. "Collaboration Using Multiple PDAs Connected to a PC," Workshop on Shared Environments to Support Face-to-Face Collaboration at CSCW'2000, Philadelphia, PA. <http://www.cs.cmu.edu/~pebbles/papers/cscw2000workshop/>
281. John Pane and Brad Myers, "The Influence of the Psychology of Programming on a Language Design:

- Project Status Report." *12th Annual Workshop of the Psychology of Programming Interest Group, PPIG 2000*, Corigliano Calabro, Italy. Apr. 10-13, 2000. pp. 193-205.
<http://www.cs.cmu.edu/~pane/PoPInfluence.html>
282. Brad Myers. "Past, Present and Future of User Interface Software Tools", (extended abstract). *Proceedings of the IEA 2000/ HFES 2000 Congress*, July 29 - August 4, 2000, San Diego, CA. p. 1-315.
283. John F. Pane and Brad A. Myers, B. A. "Improving User Performance on Boolean Queries." *Adjunct Proceedings CHI'2000: Human Factors in Computing Systems*. April 1-6, 2000. The Hague, The Netherlands. pp. 269-270. <http://www.cs.cmu.edu/~pane/BooleanQueries.html>.
284. Brad Myers, "The Pebbles Project: Using PCs and Hand-held Computers Together; Demonstration Extended Abstract." *Adjunct Proceedings CHI'2000: Human Factors in Computing Systems*. April 1-6, 2000. The Hague, The Netherlands. pp. 14-15.
285. Brad A. Myers, "Authoring Interactive Behaviors for Multimedia," *Proceedings of the 9th NEC Research Symposium: The Human-Centric Multimedia Community*, edited by T. Ishiguro. Aug 30-Sep 1, 1998, Nara, Japan. (CD Rom proceedings). [local pdf](#)
286. Brad A. Myers, "The Amulet User Interface Development Environment," (Special Interest Group Meeting), *CHI'97 Conference Companion: Human Factors in Computing Systems*. Atlanta, GA. March 22-27, 1997. p. 134.
287. Brad A. Myers, Richard G. McDaniel, Robert C. Miller, Alan Ferreny, Ellen Borison, Andrew Faulring, Andy Mickish, Patrick Doane, and Alex Klimovitski, "The Amulet User Interface Development Environment," (Video abstract), *CHI'97 Conference Companion: Human Factors in Computing Systems*. Atlanta, GA. March 22-27, 1997. pp. 214-215.
288. James A. Landay and Brad A. Myers. "Sketching Storyboards to Illustrate Interface Behaviors," *CHI'96 Conference Companion: Human Factors in Computing Systems*. Vancouver, British Columbia, Canada. April 13-18, 1996. pp. 193-194.
289. Brad A. Myers. "The Amulet User Interface Development Environment," *CHI'96 Conference Companion: Human Factors in Computing Systems*. Vancouver, British Columbia, Canada. April 13-18, 1996. p. 327.
290. Brad A. Myers, Francesmary Modugno, Rich McDaniel, David Kosbie, Andrew Werth, Robert C. Miller, John Pane, James Landay, Jade Goldstein, and Matthew A. Goldberg, "The Demonstrational Interfaces Project at CMU," *1996 AAAI Spring Symposium on Acquisition, Learning and Demonstration: Automating Tasks for Users*. March 25-27, 1996, Stanford, CA. Technical Report SS-96-02, pp. 85-91.
<ftp://ftp.cs.cmu.edu/afs/cs/project/garnet/www/pbd-group/papers/aaai96workshop.ps.Z>
291. Francesmary Modugno, Albert T. Corbett, and Brad A. Myers. "Evaluating Program Representations in a Demonstrational Visual Shell," *CHI'95 Conference Companion: Human Factors in Computing Systems*. Denver, CO. May, 1995. pp. 234-235. [video](#)
292. Brad A. Myers. "The Garnet and Amulet User Interface Development Environments," *CHI'95 Conference Companion: Human Factors in Computing Systems*. Denver, CO. May, 1995. p. 334.
293. Noi Sukaviriya, Srdjan Kovacevic, James D. Foley, Brad A. Myers, Dan R. Olsen, Jr., and Matthias Schneider-Hufschmidt, "Model-based User Interfaces: What are They and Why Should We Care?" *ACM Symposium on User Interface Software and Technology, UIST'94*, November, 1994. Los Angeles, CA. pp. 133-135.
294. Brad A. Myers. "The Garnet User Interface Development Environment: Demonstration Abstract," *CHI'94 Conference Companion*. Boston, MA, Apr. 24-28, 1994. pp. 25-26.
295. Brad A. Myers and Dan R. Olsen, Jr. "User Interface Tools: Tutorial Description" *CHI'94 Conference Companion*. Boston, MA, Apr. 24-28, 1994. pp. 421-422.
296. Francesmary Modugno and Brad A. Myers. "Pursuit: Graphically Representing Programs in a Demonstrational Visual Shell," *CHI'94 Conference Companion*. Boston, MA, Apr. 24-28, 1994. pp. 455-456. [video](#)
297. Brad A. Myers, Dario Giuse, Andrew Mickish, Brad Vander Zanden, David Kosbie, Richard McDaniel, James Landay, Matthew Goldberg, and Rajan Parthasarathy. "The Garnet User Interface Development Environment: Video Abstract," *CHI'94 Conference Companion*. Boston, MA, Apr. 24-28, 1994. pp. 455-456.
298. Gurminder Singh, Mark Linton, Brad A. Myers, and Marti Szczur. "From Research Prototypes to Usable, Useful Systems: Lessons Learned in the Trenches," *Proceedings ACM Symposium on User Interface Software and Technology: UIST'93*. Atlanta, GA, Nov 3-5, 1993. pp. 139-143.

299. Brad A. Myers, Richard Wolf, Kathy Potosnak, and Chris Graham. "Heuristics in Real User Interfaces," *Proceedings INTERCHI'93: Human Factors in Computing Systems*. Amsterdam, The Netherlands, April 24-29, 1993. pp. 304-307.
300. Andrew J. Werth and Brad A. Myers. "Tourmaline: Macrostyles by Example," *Proceedings INTERCHI'93: Human Factors in Computing Systems*. Amsterdam, The Netherlands, April 24-29, 1993. p. 532. [video](#)
301. James A. Landay and Brad A. Myers. "Extending an Existing User Interface Toolkit to Support Gesture Recognition," *Adjunct Proceedings of INTERCHI'93*. Amsterdam, The Netherlands, April 24-29, 1993. pp. 91-92.
302. Brad A. Myers. "The Garnet Gilt Interface Builder: Graphical Styles and Tabs and Techniques for Reducing Call-Back Procedures," Application Builder Session, *Seventh Annual X Technical Conference*, Boston, Massachusetts, January 18, 1993.
303. Brad A. Myers, Allen Cypher, David Maulsby, David C. Smith, and Ben Shneiderman. "Demonstrational Interfaces: Coming Soon?" *Proceedings SIGCHI'91: Human Factors in Computing Systems*. New Orleans, LA. April 28-May 2, 1991. pp. 393-396.
304. Brad A. Myers. "An Object-Oriented, Constraint-Based, User Interface Development Environment for X in CommonLisp," *Fourth Annual X Technical Conference*, Boston, Massachusetts, January 15-17, 1990.
305. Charles Wiecha, Stephen Boies, Mark Green, Scott Hudson, and Brad Myers. "Direct Manipulation or Programming: How Should We Design Interfaces?" *ACM Symposium on User Interface Software and Technology: UIST'89*, Williamsburg, VA, Nov. 13-15, 1989. pp. 124-126.
306. Brad A. Myers. "AI In Demonstrational User Interfaces," *A New Generation of Intelligent Interfaces: IJCAI-89 Workshop*, Detroit, MI. August 22, 1989, pp. 84-91.
307. Brad A. Myers. "Using AI Techniques to Create User Interfaces by Example," *Proceedings, AAAI Workshop on Architectures for Intelligent Interfaces*. March 29-April 1, 1988. Monterey, CA. pp. 305-321.
308. Brad A. Myers. "The State of the Art in Visual Programming and Program Visualization," *Proceedings: Graphics Tools for Software Engineering: Visual Programming & Program Visualization*. London, England. March 16, 1988. The British Computer Society Computer Graphics and Displays Group, International State of the Art Symposium. Reprinted in Alistair Kilgour and Rae Earnshaw, eds, *Graphics Tools for Software Engineers*. Cambridge, UK: Cambridge University Press, 1989. pp. 3-26.
309. Dan R. Olsen, David J. Kasik, Peter Tanner, Brad Myers, and Jim Rhyne. "Software Tools for User Interface Management," *Computer Graphics: SIGGRAPH '87 Conference Proceedings*. vol. 21, no. 4, July 27-31, 1987. Anaheim, CA. pp. 337-338.
310. Brad A. Myers. "Gaining General Acceptance for UIMSs," *ACM SIGGRAPH Workshop on Software Tools for User Interface Development*. November 17-19, 1986. Seattle, Washington. Reprinted in *Computer Graphics*. vol. 21, no. 2, April, 1987. pp. 130-134.
311. Brad A. Myers. "What are Visual Programming, Programming by Example, and Program Visualization?" *Proceedings Graphics Interface '86*. Vancouver, British Columbia, Canada. May 26-30, 1986. pp. 62-65.
312. Brad A. Myers. "Using Percent-Done Progress Indicators to Enhance User Interfaces," *Proceedings Graphics Interface '85*. Montreal, Quebec, Canada. May 27-31, 1985. pp. 167-170.
313. Brad A. Myers. "Strategies for Creating an Easy to Use Window Manager with Icons," *Proceedings Graphics Interface '84*. Ottawa, Ontario, Canada. May 28-June 1, 1984. pp. 227-233.

Refereed Published Videotapes:

314. Michel Beaudouin-Lafon and Wendy Mackay, "UIST 2.0 Interviews - Brad Myers", *UIST 20th Anniversary*, Newport, RI, October, 2007. [interview](#).
315. Brad Myers, David A. Weitzman, Andrew J. Ko, and Duen Horng Chau, "The Crystal Framework and Editor for Answering Why and Why Not Questions". Video Figure (3:48 min). CHI'06. [video](#)
316. Brad A. Myers, Jeffery Stylos, Andrew Faulring. "The Citrine Intelligent Copy and Paste System." 4:44 minute video. [quicktime format](#) (57 megabytes). *ACM Symposium on User Interface Software and Technology, UIST'04*, October 24-27, 2004, Santa Fe, NM.
317. Brad A. Myers, Richard G. McDaniel, Robert C. Miller, Alan Ferrency, Ellen Borison, Andrew Faulring, Andy Mickish, Patrick Doane, and Alex Klimovitski, *The Amulet User Interface Development Environment*. 8 minute video. Technical Video Program of the CHI'97 conference. ACM, 0-89791-876-2.

OpenVideo version

318. Brad A. Myers, Dario Giuse, Andrew Mickish, Brad Vander Zanden, David Kosbie, Richard McDaniel, James Landay, Matthew Goldberg, and Rajan Parthasarathy. *The Garnet User Interface Development Environment*. Technical Video Program of the CHI'94 conference. *SIGGRAPH Video Review*, Issue 97, no. 13. ACM, ISBN 0-89791-940-8.
319. Francesmary Modugno and Brad A. Myers. "Pursuit: A Demonstrational Visual Shell," Technical Video Program of the CHI'94 conference. *SIGGRAPH Video Review*, Issue 97, no. 12. [video](#)
320. Andrew J. Werth and Brad A. Myers. "Tourmaline: Macrostyles by Example," Technical Video Program of the INTERCHI'93 conference. Amsterdam, The Netherlands, April 24-29, 1993. *SIGGRAPH Video Review*, Issue 89, no. 17. [video](#)
321. Brad A. Myers, Andrew Mickish and Osamu Hashimoto. "The Garnet Gilt Interface Builder: Graphical Styles and Tabs and Techniques for Reducing Call-Back Procedures," Application Builder Video Session, *Seventh Annual X Technical Conference*, Boston, Massachusetts, January 18, 1993. 10 minutes. [video](#)
322. Brad Vander Zanden and Brad A. Myers. *Creating Graphical Interactive Application Objects by Demonstration: The Lapidary Interface Design Tool*. 12 minute videotape. Technical Video Program of the SIGCHI'91 conference, New Orleans, LA. April 28-May 2, 1991. *SIGGRAPH Video Review*, Issue 64, no. 1. [video](#)
323. Brad A. Myers. *Some of the Widgets*. 17 minute videotape. Technical Video Program of Interact'90. Cambridge, England. August 27-31, 1990.
324. Brad A. Myers. *All the Widgets*. 2 hour, 15 min videotape. Technical Video Program of the SIGCHI'90 conference, Seattle, WA. April 1-4, 1990. *SIGGRAPH Video Review*, Issue 57. ISBN 0-89791-930-0. [wmv file \(600MB\)](#). Formerly available as ACM Order Number 608903 from [ACM Press](#) (out of print). (Some segments are available in the [open video collection](#), search down for "All the widgets"). [SIGCHI reference](#).
325. Brad A. Myers, editor. *CHI'90 Formal Video Program*. Technical Video Program of the SIGCHI'90 conference, Seattle, WA. April 1-4, 1990. *SIGGRAPH Video Review*, Issues 55-56. ISBN 0-89791-928-9.
326. Brad A. Myers, editor. *SIGGRAPH Video Review*, Issues 58-59.
327. Brad A. Myers. *Creating User Interfaces by Demonstration: The Peridot UIMS*. Technical Video Program of the SIGCHI'88 Conference, Washington, D.C., May 15-19, 1988. and IFIP Interact '87 Conference on Human-Computer Interaction. Stuttgart, West Germany. Sept. 1-4, 1987. *SIGGRAPH Video Review*, Issue 59, no. 2. 18 minutes. [8-min video](#), or [15-min video](#)
328. Brad A. Myers. *Percent-Done Progress Indicators in Practice and Experiments*, Videotape shown at SIGCHI '85. San Francisco, CA. Apr. 14-18, 1985. *SIGGRAPH Video Review*, Issue 19, no. 6.
329. Brad A. Myers. "The User Interface for Sapphire," Videotape. *Human Factors in Computing Systems; SIGCHI '85 Videotape Review*. San Francisco, CA. Apr 14-18, 1985. Also shown at the Annual Meeting of the American Society for Information Science. Las Vegas, Nev. October 20-24, 1985. *SIGGRAPH Video Review*, Issue 19, no. 5.

Technical Reports:

330. Len Bass, Grace A. Lewis, Brad Myers, & Dennis B. Smith, *Proceedings of the Workshop on Software Engineering Foundations for End-User Programming (SEEUP 2009)*. CMU/SEI-2009-SR-015. Carnegie Mellon University, Software Engineering Institute, Research, Technology, and System Solutions (RTSS) Program. November, 2009. [abstract](#) and [pdf](#).
331. Christopher Scaffidi, Brad Myers, and Mary Shaw. "An Editor and Parser for Data Formats in End-User Programming". CMU-ISRI-07-104 and CMU-HCII-07-100. Carnegie Mellon University School of Computer Science, May, 2007. [pdf](#)
332. Margaret Burnett, Brad Myers, Mary Beth Rosson, Susan Wiedenbeck, and Adam Leibel. "Workshop Report: From End-User Programming to End-User Software Engineering (a CHI'06 Workshop)". Oregon State University School of Electrical Engineering and Computer Science Technical Report TR CS07-60-04, April, 2007. [abstract](#) and [pdf](#)
333. Chris Scaffidi, Allen Cypher, Sebastian Elbaum, Anndy Koesnandar, Brad Myers. "The EUSES Web Macro Scenario Corpus, Version 1.0". November 2006, CMU-HCII-06-105. [pdf](#)
334. Anthony Tomasic, R. Martin McGuire, and Brad Myers. "Workflow by example: Automating database interactions via induction." Technical report CMU-ISRI-06-103, Carnegie Mellon University, March

2006. [pdf](#)
335. Christopher Scaffidi, Andrew Ko, Brad Myers, Mary Shaw, "Identifying Types of End Users: Hints from an Informal Survey". Carnegie Mellon University ISRI Technical Report, no. CMU-HCII-05-101 and Human Computer Interaction Institute Technical Report CMU-ISRI-05-110. April, 2005.
336. Christopher Scaffidi, Mary Shaw, Brad Myers. "The "55M End-User Programmers" Estimate Revisited". Carnegie Mellon University ISRI Technical Report, no. CMU-ISRI-05-100 and Human Computer Interaction Institute Technical Report CMU-HCII-05-100. February, 2005. [pdf](#)
337. Franklin Chen, Brad Myers and David Yaron, *Using Handheld Devices for Tests in Classes*. Carnegie Mellon University School of Computer Science Technical Report, no. CMU-CS-00-152 and Human Computer Interaction Institute Technical Report CMU-HCII-00-101. July, 2000.
<http://www.cs.cmu.edu/~pebbles/papers/CMU-CS-00-152.pdf> or
<http://www.cs.cmu.edu/~pebbles/papers/CMU-CS-00-152.ps>
338. Brad A. Myers. *An Implementation Architecture to Support Single-Display Groupware*. Carnegie Mellon University School of Computer Science Technical Report, no. CMU-CS-99-139 and Human Computer Interaction Institute Technical Report CMU-HCII-99-101. May, 1999.
<http://www.cs.cmu.edu/~pebbles/papers/pebblesarchtr.ps>
<http://www.cs.cmu.edu/~pebbles/papers/pebblesarchtr.pdf>
339. John F. Pane, Chotirat "Ann" Ratanamahatana, and Brad A. Myers. *Analysis of the Language and Structure in Non-Programmers' Solutions to Programming Problems*. Carnegie Mellon University School of Computer Science Technical Report, no. CMU-CS-98-160 and Human Computer Interaction Institute Technical Report CMU-HCII-98-102. September, 1998.
340. Brad A. Myers. *The Case for an Open Data Model*. Carnegie Mellon University School of Computer Science Technical Report, no. CMU-CS-98-153 and Human Computer Interaction Institute Technical Report CMU-HCII-98-101. August, 1998. <http://reports-archive.adm.cs.cmu.edu/anon/1998/CMU-CS-98-153.ps> <http://reports-archive.adm.cs.cmu.edu/anon/1998/CMU-CS-98-153.pdf>
341. Brad A. Myers. *Natural Programming: Project Overview and Proposal*. Carnegie Mellon University School of Computer Science Technical Report, no. CMU-CS-98-101 and Human Computer Interaction Institute Technical Report CMU-HCII-98-100. January, 1998. [html](#) or [pdf](#)
342. Robert C. Miller, Brad A. Myers. *Creating Dynamic World Wide Web Pages by Demonstration*. Carnegie Mellon University School of Computer Science Technical Report, no. CMU-CS-97-131 and Human Computer Interaction Institute Technical Report CMU-HCII-97-101. May, 1997. [postscript](#) or [pdf](#)
343. Brad A. Myers, Ellen Borison, Alan Ferency, Rich McDaniel, Robert C. Miller, Andrew Faulring, Bruce D. Kyle, Patrick Doane, Andy Mickish, and Alex Klimovitski. *The Amulet V3.0 Reference Manual*. Carnegie Mellon University School of Computer Science Technical Report, no. CMU-CS-95-166-R2 and Human Computer Interaction Institute Technical Report CMU-HCII-95-102-R2. March, 1997. [HTML version](#)
344. Richard G. McDaniel and Brad A. Myers, *Improving Demonstration Using Better Interaction Techniques*. Carnegie Mellon University School of Computer Science Technical Report CMU-CS-97-103 and Human Computer Interaction Institute Technical Report CMU-HCII-97-100, January, 1997. <http://reports-archive.adm.cs.cmu.edu/anon/1997/CMU-CS-97-103.ps>
345. Brad A. Myers. *A Brief History of Human Computer Interaction Technology*. Carnegie Mellon University School of Computer Science Technical Report CMU-CS-96-163 and Human Computer Interaction Institute Technical Report CMU-HCII-96-103, December, 1996.
<http://www.cs.cmu.edu/~amulet/papers/uihistory.tr.html> or [postscript](#). (View this report in Romanian courtesy of [azoff](#))
346. Brad A. Myers, Rich McDaniel, Rob Miller, Alan Ferency, Patrick Doane, Andrew Faulring, Ellen Borison, Andy Mickish, and Alex Klimovitski *The Amulet Environment: New Models for Effective User Interface Software Development*. Carnegie Mellon University School of Computer Science Technical Report CMU-CS-96-189 and Human Computer Interaction Institute Technical Report CMU-HCII-96-104, November, 1996. <http://reports-archive.adm.cs.cmu.edu/anon/1996/CMU-CS-96-189.ps>
<http://www.cs.cmu.edu/~amulet/papers/amuletcn.ps> [abstract only:](#)
<http://www.cs.cmu.edu/~amulet/papers/amuletcn.abs.html>
347. John Pane and Brad Myers. *Usability Issues in the Design of Novice Programming Systems*, Carnegie Mellon University School of Computer Science Technical Report CMU-CS-96-132. and Human Computer Interaction Institute Technical Report CMU-HCII-96-101, August, 1996.

- <http://www.cs.cmu.edu/~pane/cmu-cs-96-132.html> <http://reports-archive.adm.cs.cmu.edu/anon/1996/CMU-CS-96-132.ps>
348. Brad A. Myers, Alan Ferreny, Rich McDaniel, Robert C. Miller, Patrick Doane, Andy Mickish, Alex Klimovitski. *The Amulet V2.0 Reference Manual*. Carnegie Mellon University School of Computer Science Technical Report, no. CMU-CS-95-166-R1 and Human Computer Interaction Institute Technical Report CMU-HCII-95-102-R1. February, 1996. [html](#)
349. James A. Landay and Brad A. Myers. *Just Draw It! Programming by Sketching Storyboards*. Carnegie Mellon University School of Computer Science Technical Report, no. CMU-CS-95-199 and Human Computer Interaction Institute Technical Report CMU-HCII-95-106. November, 1995. <http://reports-archive.adm.cs.cmu.edu/anon/1995/CMU-CS-95-199.ps>
<http://www.cs.cmu.edu/afs/cs.cmu.edu/user/landay/pub/www/research/publications/storyboard-tr/storyboard.html>
350. Rich McDaniel and Brad A. Myers. *A Dynamic And Flexible Prototype-Instance Object And Constraint System In C++*. Carnegie Mellon University School of Computer Science Technical Report, no. CMU-CS-95-176 and Human Computer Interaction Institute Technical Report CMU-HCII-95-104. July, 1995. <http://reports-archive.adm.cs.cmu.edu/anon/1995/CMU-CS-95-176.ps>
351. Brad A. Myers, Rich McDaniel, Alan Ferreny, Andy Mickish, Alex Klimovitski, and Amy McGovern. *The Amulet Reference Manuals*. Carnegie Mellon University School of Computer Science Technical Report, no. CMU-CS-95-166 and Human Computer Interaction Institute Technical Report CMU-HCII-95-102. June, 1995. [postscript](#)
352. Nobuhisa Yoda and Brad A. Myers. *An Architectural Design of A Toolkit for Synchronous Groupware Applications*. Carnegie Mellon University School of Computer Science Technical Report, no. CMU-CS-94-226 and Human Computer Interaction Institute Technical Report CMU-HCII-94-109. December 1994.
353. Brad A. Myers. *User Interface Software Tools*. Carnegie Mellon University School of Computer Science Technical Report, no. CMU-CS-94-182 and Human Computer Interaction Institute Technical Report CMU-HCII-94-107. August 1994. <http://reports-archive.adm.cs.cmu.edu/anon/1994/CMU-CS-94-182.ps>
354. James A. Landay and Brad A. Myers. *Interactive Sketching for the Early Stages of User Interface Design*. Carnegie Mellon University School of Computer Science Technical Report, no. CMU-CS-94-176 and Human Computer Interaction Institute Technical Report CMU-HCII-94-104. July 1994.
355. David S. Kosbie and Brad A. Myers. *Extending Programming by Demonstration with Hierarchical Event Histories*. Carnegie Mellon University School of Computer Science Technical Report, no. CMU-CS-94-156 and Human Computer Interaction Institute Technical Report CMU-HCII-94-102. May 1994. <http://reports-archive.adm.cs.cmu.edu/anon/1994/CMU-CS-94-156.ps>
356. Brad A. Myers, Dario A. Giuse, Andrew Mickish, and David S. Kosbie. *Making Structured Graphics and Constraints Practical for Large-Scale Applications*. Carnegie Mellon University School of Computer Science Technical Report, no. CMU-CS-94-150 and Human Computer Interaction Institute Technical Report CMU-HCII-94-100. May 1994. <http://reports-archive.adm.cs.cmu.edu/anon/1994/CMU-CS-94-150.ps>
357. Francesmary Modugno and Brad A. Myers. *Pursuit: Visual Programming in a Visual Domain*. Carnegie Mellon University School of Computer Science Technical Report, no. CMU-CS-94-109. January 1994.
358. Brad A. Myers. *Why are Human-Computer Interfaces Difficult to Design and Implement?* Carnegie Mellon University School of Computer Science Technical Report, no. CMU-CS-93-183 July 1993. <http://reports-archive.adm.cs.cmu.edu/anon/1993/CMU-CS-93-183.ps>
359. Francesmary Modugno and Brad A. Myers. *Visual Representations as Feedback in a Programmable Visual Shell*. Carnegie Mellon University School of Computer Science Technical Report, no. CMU-CS-93-133. March 1993.
360. Francesmary Modugno and Brad A. Myers. *Typed Output and Programming in the Interface*. Carnegie Mellon University School of Computer Science Technical Report, no. CMU-CS-93-134. March 1993.
361. Brad A. Myers, editor. *The Second Garnet Compendium: Collected Papers, 1990-1992*. Carnegie Mellon University School of Computer Science Technical Report, no. CMU-CS-93-108, February, 1993. 135 pages.
362. Bonnie E. John, Philip L. Miller, Brad A. Myers, Christine M. Neuwirth, and Steven A. Shafer, eds. *Human-Computer Interaction in the School of Computer Science*. Carnegie Mellon University School of Computer Science Technical Report, no. CMU-CS-92-193, October, 1992.
363. Brad A. Myers. *State of the Art in User Interface Software Tools*. Carnegie Mellon University School of

- Computer Science Technical Report, no. CMU-CS-92-114, February, 1992.
364. Brad A. Myers and Mary Beth Rosson. *Survey on User Interface Programming*. Carnegie Mellon University School of Computer Science Technical Report, no. CMU-CS-92-113, February, 1992. Also published as IBM Research Report RC17624.
 365. Brad A. Myers. *Demonstrational Interfaces: A Step Beyond Direct Manipulation*. Carnegie Mellon University School of Computer Science Technical Report, no. CMU-CS-90-162, August, 1990.
 366. Brad A. Myers, editor. *The Garnet Compendium: Collected Papers, 1989-1990*. Carnegie Mellon University School of Computer Science Technical Report, no. CMU-CS-90-154, August, 1990.
 367. Brad A. Myers, Dario Giuse, Andrew Mickish, Brad Vander Zanden, David Kosbie, James A. Landay, Richard McDaniel, Rajan Parthasarathy, Matthew Goldberg, Roger B. Dannenberg, Philippe Marchal, Ed Pervin. *The Garnet Reference Manuals*. Carnegie Mellon University Computer Science Department Technical Report, no. CMU-CS-90-117-R5, Sep. 1994. Revised from CMU-CS-90-117-R4, Oct. 1993, CMU-CS-90-117-R3, Nov. 1992, CMU-CS-90-117-R2, May 1992, CMU-CS-90-117-R, June 1991, CMU-CS-90-117, March, 1990, and CMU-CS-89-196, Nov. 1989.
 368. Brad A. Myers. *The Garnet User Interface Development Environment; A Proposal*. Carnegie Mellon University Computer Science Department Technical Report, no. CMU-CS-88-153, Sept, 1988.
 369. Brad A. Myers. "The State of the Art in Visual Programming and Program Visualization," Carnegie Mellon University Computer Science Department Technical Report, no. CMU-CS-88-114, Feb, 1988.
 370. Brad A. Myers, editor. *Speculations on The Personal Computer of the Year 2000*. Carnegie Mellon University Computer Science Department Technical Report, no. CMU-CS-88-115, Feb, 1988.
 371. Brad A. Myers. *Tools for Creating User Interfaces: An Introduction and Survey*, Carnegie Mellon University Computer Science Department Technical Report, no. CMU-CS-88-107, Jan, 1988.
 372. Brad A. Myers. *Creating User Interfaces by Demonstration*. PhD Thesis. May, 1987. Technical Report CSRI-196, Computer Systems Research Institute, University of Toronto, Toronto, Ontario, Canada, M5S 1A1.
 373. Brad A. Myers. "Position Paper for the SIGCHI Workshop on Classification of Dialog Techniques," *Report of the ACM SIGCHI+GI '87 Workshop on Classification of Dialog Techniques*, Toronto, Canada, April 6, 1987. Jacob Nielsen, ed. Technical Report ID-TR-1987-25, Department of Computer Science, Technical University of Denmark, Bldg. 344, DK-2800 Lyngby Copenhagen, Denmark, 1987. pp. 49-51. Summary of workshop appears in *SIGCHI Bulletin*, vol. 19, no. 2, Oct, 1987, pp. 30-35.
 374. J.E. Ball, B. Bruegge, H. Mauersberg, and B.A. Myers. *Spice Symbols: Accessing Type Information in High Level Languages*. Technical Report, Corporate Technology and Research, Siemens Corporation. Nov, 1981.
 375. Brad A. Myers. *Displaying Data Structures for Interactive Debugging*. XEROX Palo Alto Research Center Technical Report CSL-80-7. June, 1980. 97 pages. <http://www.cs.cmu.edu/~bam/MyersCSL-80-7.pdf>

Other Publications:

376. Brad Myers, Alexander Repenning, Peter Lucas, Walter van Roggen, Allen Cypher, Andrew Dove, and Ofer Brandes, "Successful Visual and End-User Programming Systems from Industry," Invited panel at the *2011 IEEE Symposium on Visual Languages and Human-Centric Computing (VL/HCC'11)*, Pittsburgh, PA, Sept. 18–22, 2011. p. 5. [local.pdf](#)
377. Brad A. Myers, *Commentary on 'Visual Representation' by Alan Blackwell*. Interaction-Design.org. January 31, 2011. http://www.interaction-design.org/encyclopedia/visual_representation.html#brad+a.+myers.
378. Grace Lewis, Dennis Smith, Len Bass, Brad Myers, "Report of the Workshop on Software Engineering Foundations for End-User Programming," *ACM SIGSOFT Software Engineering Notes*, Volume 34, no. 5, September 2009, pp. 51-54. [ACM DL](#)
379. Andrew J. Ko, Robin Abraham, Margaret M. Burnett, Brad A. Myers, "End-User Software Engineering: Guest Editors' Introduction", *IEEE Software*, vol 26, no. 5, September/October, 2009, pp. 16-17. [IEEE DL pdf](#)
380. Brad Myers, "Engineering More Natural Interactive Programming Systems," (invited keynote talk abstract). *ACM SIGCHI Symposium on Engineering Interactive Computing Systems (EICS'2009)*, Pittsburgh, PA, July 14-17, 2009. p. 1. [pdf of talk slides with references](#)

381. John M. Daughtry, Umer Farooq, Brad A. Myers and Jeffrey Stylos. "API usability: Report on Special Interest Group at CHI". *Software Engineering Notes*. vol. 34, no. 4, July, 2009. pp. 27-29. [pdf](#) or [ACM DL](#)
382. Andrew Sears, Vicki L. Hanson, Brad Myers, "Introduction to the Special Issue on Computers and Accessibility", *ACM Transactions on Computer Human Interaction*, Vol. 14, no. 3, Sep, 2007, pp. 11-1 - 11-3.
383. M. H. Burnett, G. Engels, B. A. Myers, G. Rothermel (Eds.), *End-User Software Engineering*, Dagstuhl Seminar Proceedings 07081, 18.02. - 23.02.2007, ISSN 1862 - 4405. [html](#) or [pdf](#)
384. Ben Shneiderman, Gerhard Fischer, Mary Czerwinski, Brad Myers, and Mitch Resnick, editors, *Creativity Support Tools*, Report of a Workshop sponsored by the National Science Foundation. (75 pages). [pdf](#).
385. Mitch Resnick, Brad Myers, and Randy Pausch, Kumiyo Nakakoji, Ben Shneiderman, Randy Pausch, Ted Selker, and Mike Eisenberg, "Design Principles for Tools to Support Creative Thinking," in *Creativity Support Tools*. pp. 25-36. [pdf](#), or [html](#)
386. Brad A. Myers and Michael Beigl, "Handheld Computing" (Guest Editors' Introduction), *IEEE Computer*, September, 2003, vol. 36, no. 9, pp. 27-29. [pdf](#)
387. Brad Myers, "Towards More Natural Functional Programming Languages," (invited keynote talk abstract). *The Seventh ACM SIGPLAN International Conference on Functional Programming, ICFP 2002*. October 4-6, 2002, Pittsburgh, PA. p. 1.
388. Brad A. Myers and Jeffrey Nichols, "Communication Ubiquity Enables Ubiquitous Control," 'Booster' for *Human-Computer Interaction Consortium (HCIC'2002)*, Winter Park, CO, Feb 1, 2002. [html](#)
389. Bernhard Suhm, Brad Myers and Alex Waibel, "Multi-Modal Error Correction for Speech User Interfaces; Research Alert," *ACM Interactions*. vol. 8, no. 1. jan+feb, 2001. pp. 16-17.
390. Brad Myers, Scott E. Hudson, and Randy Pausch, "Past, Present and Future of User Interface Software Tools; Research Alert," *ACM Interactions*. vol. 7, no. 6. nov+dec, 2000. pp. 15-16.
391. Brad A. Myers. Review of Jon O'Brien, Tom Rodden, Mark Rouncefield, and John Hughes, "At Home with the Technology: An Ethnographic Study of a Set-Top-Box Trial", *ACM Computing Reviews*, April, 2000. p. 216.
392. Brad A. Myers. Review of Jakob Nielsen, "User Interface Directions for the Web," *ACM Computing Reviews*, June, 1999. p. 313.
393. Brad A. Myers. Review of Andruid Kerne, "Cultural Representation in Interface Ecosystems: Amendments to the ACM/Interactions Design Awards Criteria." *ACM Computing Reviews*, December, 1998. p. 624.
394. Brad A. Myers. Review of Benjamin Watson, Neff Walker, Larry Hodges, and Aileen Worden, "Managing Level of Detail through Peripheral Degradation: Effects on Search Performance in a Head-Mounted Display." *ACM Computing Reviews*, August, 1998. p. 427.
395. Brad A. Myers. "Programmability and Heuristics in the User Interface" *ACM Computing Surveys*, vol. 28A(4), December 1996, <http://www.cs.cmu.edu/~bam/nsfworkshop/mystatement.html>
396. Brad A. Myers. Review of Saul Greenberg, "Teaching human computer interaction to programmers." *ACM Computing Reviews*, July, 1997. vol. 38, no. 7. p. 361.
397. Brad A. Myers. Review of Jeff A. Johnson, "Creating Presentation Slides: a Study of User Preferences for Task-Specific versus Generic Software." *ACM Computing Reviews*, Oct, 1996. vol. 37, no. 10. p. 539.
398. Brad A. Myers. Review of Y.K. Leung and M.D. Apperley, "A Review and Taxonomy of Distortion-Oriented Presentation Techniques." *ACM Computing Reviews*, Vol. 3, no. 4, April, 1995. p. 217.
399. Shannon Ford and Brad A. Myers, eds. *The Human-Computer Interaction Institute*. Carnegie Mellon University. April, 1995. 81 pages.
400. Brad Myers. "The Design for the Amulet User Interface Toolkit," Human-Computer Interaction Consortium, Winter Park, CO. February 15-19, 1995. 8 pages. Available as: <ftp://ftp.cs.cmu.edu/afs/cs/project/amulet/www/amulethicic.ps>
401. Brad Myers. *Guide for New Faculty in the School of Computer Science*. May, 1994 (revised from version of August 30, 1993.) Memorandum circulated to the CMU CS and RI faculty.
402. Bill Hefley, John Rheinfrank, and Brad A. Myers. "Interactions: A New ACM User Interface Magazine" *SIGCHI Bulletin*, vol. 25, no. 2, April, 1993. pp. 15-19.
403. Brad A. Myers, "Report on the CHI'91 Workshop on Languages for Developing User Interfaces," *SIGCHI Bulletin*, vol. 25, no. 2, April, 1993. pp. 20-23.
404. Brad A. Myers, "Report on the CHI'91 Workshop on Languages for Developing User Interfaces,"

SIGPLAN Notices, vol. 27, no. 12, Dec, 1992. pp. 8-12.

405. Tyson R. Henry, Scott E. Hudson, Andrey K. Yeatts, Brad A. Myers, and Steven Feiner. "A Nose Gesture Interface Device: Extending Virtual Realities," *ACM Symposium on User Interface Software and Technology*, Hilton Head, SC, Nov. 11-13, 1991. pp. 65-68. Reprinted in *Presence*, MIT Press Journals, vol. 1, no. 2, April, 1992. [PDF](#)
406. Brad A. Myers and Mary Beth Rosson, "User Interface Programming Survey" *SIGCHI Bulletin*. vol. 23, no. 2. April, 1991. pp. 27-30. also in *SIGPLAN Notices*, vol. 26, no. 8, Aug, 1991. pp. 19-22.
407. Brad A. Myers, "Status Report on the User Interface Magazine" *SIGCHI Bulletin*. vol. 23, no. 2. April, 1991. pp. 10-12.
408. Brad A. Myers. "Making it Easy to Create Highly-Interactive, Graphical Applications in Lisp," *XNextEvent: The Official Newsletter of XUG, the X User's Group*. vol. 3, no. 1. May, 1990. pp. 1, 16-22.
409. Brad A. Myers, "A New Magazine on Computer-Human Interaction?" *SIGCHI Bulletin*. April, 1990. pp. 8-11.
410. Brad A. Myers, Andrew Schulert, Smokey Wallace, Owen Densmore, and David Goldsmith, "User Interface Toolkits: Present and Future," *SIGGRAPH '88 Panels Proceedings*, Atlanta, GA, August 1-5, 1988.
411. Bill Heil, Brad A. Myers and Larry S. Rosenstein. "Software for a Versatile Message Display System," *IEEE 1979-1980 Student Papers*, TT0114-9. pp. 5-12.

Patents:

412. Brad A. Myers and Andrew J. Ko. "Debugging Interface." US Patent Number 7,735,066. Issued: June 8, 2010. Filed October 7, 2005, claiming priority to provisional filed October 8, 2004. [pdf](#)
413. Jacob O. Wobbrock and Brad A. Myers. "Using Edges and Corners for Character Input." US Patent No. 7,729,542, issued June 1, 2010, Filed March 29, 2004, claiming priority to provisional filed April 4, 2003. [pdf](#)
414. Brad A. Myers, Jade Goldstein, and Matthew A. Goldberg. "Creating Charts and Visualizations by Demonstration." Patent Number 5,581,677. Filed April 22, 1994. [pdf](#)

Submitted for Publication:

415. YoungSeok Yoon, Sebon Koo and Brad A. Myers, "A Selective Undo Mechanism for Code Editors"
416. Erik Harpstead, Brad Myers, Vincent Aleven, "In Search of Learning: Facilitating Data Analysis in Educational Games"
417. Brad A. Myers, Mi-Kyung Song, Mary Amanda Dew, Alex Begey, Jill Aubrecht, Lorrienne Nault, Ruosha Li, and Annette DeVito Dabbs, "Pocket PATH: Handheld and Web Applications to Improve Self-Care Behaviors"
418. Kerry S. Chang, Brad A. Myers, Gene M. Cahill, Soumya Simanta, Edwin Morris and Grace Lewis. "Listpad: Creating Customized Structured Data on Mobile Devices"
419. Annette DeVito Dabbs, Mi-Kyung Song, Brad Myers, Lauren Terhorst, Robert P. Hawkins, Yoshiya Toyoda, Jill Aubrecht, Joseph M. Pilewski, Christian A. Bermudez, Mary Amanda Dew. "Unique Considerations for Conducting RCTs of Health IT Interventions or Conducting RCTs to Evaluate Interventions involving Health Information Technology"
420. Christian Dörner, Brad A. Myers. "EUKLAS: Supporting Copy-and-Paste Strategies for Integrating Example Code"
421. Thomas D. LaToza, Brad A. Myers, Jonathan Aldrich. "Searching Along Control Flow Paths"

Unpublished

422. Andrew Faulring and Brad A. Myers, "Visualizing and Manipulating Complex Calendar Scheduling Information" [pdf](#)
423. Jeffrey Nichols and Brad Myers. *Report on the INCITS/V2 AIAP-URC Standard*. 2004. [pdf](#)
424. A. Chris Long, Brad A. Myers, Juan Casares, Scott M. Stevens, and Albert Corbett. "Video Editing Using Lenses and Semantic Zooming". 2003. [pdf](#)

425. Brad A. Myers, Yu Shan A. Chuang, Marsha Tjandra, Mon-chu Chen, and Chun-Kwok Lee. "Floor Control in a Highly Collaborative Co-Located Task." 2000.
<http://www.cs.cmu.edu/~pebbles/papers/pebblesfloorcontrol.pdf>
426. Karen Cross, Adrienne Warmack, and Brad Myers. "Lessons Learned: Using Contextual Inquiry Analysis to Improve PDA Control of Presentations". 1999.
<http://www.cs.cmu.edu/~pebbles/papers/pebblesslideshowci.pdf>
427. Richard G. McDaniel and Brad A. Myers, "Gamut: Creating Complete Applications Using Only Programming-by-Demonstration." 1999. [postscript](#).
428. Brad A. Myers and Kenneth A. Strickland. "Easily Adding Sound Output to Interfaces." 1998.
<http://www.cs.cmu.edu/~amulet/papers/soundinamulet.pdf>
<http://www.cs.cmu.edu/~amulet/papers/soundinamulet.ps>
429. John Huebner and Brad A. Myers. "Easily Programmable Shared Objects For Peer-To-Peer Distributed Applications." 1998. <http://www.cs.cmu.edu/~amulet/papers/Submitted-sharedobj.ps>
<http://www.cs.cmu.edu/~amulet/papers/Submitted-sharedobj.pdf>
<http://www.cs.cmu.edu/~amulet/papers/Submitted-sharedobj.html>
430. Ilhwan Kwon and Brad A. Myers. "Defining and Editing Constraints Graphically by Treating Constraints as Objects." 1998.
431. Brad A. Myers, Neal Altman, Khalil Amiri, Matthew Centurion, Fay Chang, Chienhao Chen, Herb Derby, John Huebner, Rich Kaylor, Ralph Melton, Robert O'Callahan, Matthew Tarpy, Konur Unyelioglu, Zhenyu Wang, and Randon Warner. "Using Benchmarks to Teach and Evaluate User Interface Tools." 1997. <http://www.cs.cmu.edu/~amulet/papers/benchmarks.pdf>
432. Brad A. Myers, Alan Ferrency, Rich McDaniel and Roger Dannenberg. "Debugging Interactive Applications." 1996. <http://www.cs.cmu.edu/~amulet/papers/debugpaper.pdf>

World Wide Web Pages:

1. Brad Myers [home page](#). Including [List of Systems and Their Acronyms](#) and [CHI Conference Badges](#)
2. *Natural Programming Project Pages* <http://www.cs.cmu.edu/~NatProg>
3. *Pebbles Project Pages* <http://www.cs.cmu.edu/~pebbles>. Featured in the January 6, 2003, Vol. 5, no. 15, issue of the *Innovative Teaching Newsletter* on "PDAs in the Classroom".
4. *User Interface Software Tools*. <http://www.cs.cmu.edu/~bam/toolnames.html>
A list of tools for creating user interfaces. (Awarded Editor's Choice, LookSmart Directory, a subsidiary of *The Reader's Digest*, Jan 22, 1997. Links2Go Key Resource award in the GUI topic, 22 Jul 98.)
5. *Computer Almanac - Numbers About Computers* <http://www.cs.cmu.edu/~bam/numbers/>
Interesting and Useful Numbers about Computers. (Top link on the original The Microsoft Network "Look it Up" page; selected for the "Exclusive Kool Sites" award from Komputer Klinik for June 14, 1996; Awarded four stars by Anbar Electronic Intelligence Computing Cool Sites for the January'98 Computing Milieux; Listed in Mexico's FirstNews: Internet at Home, Computers, Information and Opinion Articles, March'98; Earned the "Duke of URL Classy Site Pick Award," May, 1998; included in Addison Wesley Longman Publishing Company's on-line text books by [Neil A. Weiss on Statistics](#). Featured link in [LibrarySpot's Almanac Page](#), April, 2000.)
6. *Amulet Project Pages* <http://www.cs.cmu.edu/~amulet>
7. *Demonstrational Interfaces Project Pages* <http://www.cs.cmu.edu/~bydemo>
8. *Garnet Project Pages* <http://www.cs.cmu.edu/~garnet>
9. *Command Post of the Future (CPOF) Project Pages* <http://www.cs.cmu.edu/~cpof>
10. *Silver Multi-media Editing Project Pages* <http://www.cs.cmu.edu/~silver>

Articles by Others Quoting Me or About My Work:

1. Byron Spice, "IEEE Confers Prestigious Fellow Status On Four Carnegie Mellon Faculty Members", CMU Press Release, December 5, 2012, [on-line](#), and [local copy](#).
2. "News Brief: HCII Paper of 2002 Named 'Most Influential'", CMU Press Release, September 25, 2012,

- [html](#).
- "Myers, two alumni recognized for 'most influential' paper", *The Link*, Fall, 2012, issue 7.0, p. 37. [on-line version](#).
 - A shorter version [mentioned here](#).
3. Bianca Bosker, "Meet The iPad 13: Imagining The iPad, Decades From Now", *The Huffington Post*, 3/8/2012, [html](#) or [local pdf](#)
 4. Byron Spice, "Symposium explores how computer programs can be made easier to write and understand", Press Release, 6-Jul-2011. [CMU](#) and [SCS](#) and [HCIL](#), or [local pdf](#). Picked up by:
 1. [EurekAlert!](#)
 5. Rob Knies, "April in Paris: European Software Focus", *Microsoft Research Press Release*, April 14, 2011, [html](#) and [local pdf](#). (quoted in: *R&D Mag*, April 25, 2011, [html](#)). Mentioned in CMU news item: [html](#).
 6. Jessica Mintz, "Designs with a Deeper Purpose: Software specialist Bill Buxton wants designers to think more carefully about which innovations to pursue," *Technology Review*, April 21, 2011. [html](#) and [local pdf](#)
 7. Paul Krill, "Microsoft, IBM highlight software development advances", *InfoWorld*, 07/09/2009, [html](#), and [local pdf](#).
 8. Byron Spice, "Carnegie Mellon develops Java programming tools employing human-centered design techniques", Press Release, 17-Jun-2009. [CMU](#) and [SCS](#) and [HCIL](#), or [local pdf](#). Picked up by:
 1. Paul Leahy, "A Better Way to Search the Java API?", *About.com:Java*, June 18, 2009, [html](#) or [local pdf](#)
 2. Alpha Doggs, "What's behind Carnegie Mellon's cool new Java acronyms: Java tools employ human-centered design methods", *NetworkWorld.com*, 06/17/09, [html](#) or [local pdf](#)
 3. Dr. Dobb's, "[Finding Java API Methods and Classes](#)", June 17, 2009
 4. Tania Andersen, "Nyt værktøj finder nålen i API-høstakken" (in Danish), *Version2*, June 23, 2009, [html](#), [Google's translation](#), or [local pdf](#) or [local image](#)
 5. Paolo Raviola, "Orientarsi tra classi e metodi di Java" (in Italian), *Programmazione.it v6.2*, June 24, 2009, [html](#), [Google's translation](#), or [local pdf](#)
 6. Liz Tay, "Java tool trebles developer speed", *itnews for Australian Business*, June 26, 2009, [html](#) or [local pdf](#)
 7. [EurekAlert](#)
 8. [ScienceBlog](#)
 9. [GUI PROGRAM NEWS](#)
 10. [Science Centric](#)
 11. [BrightSurf.com](#)
 12. [Congo](#)
 13. [MacTech Magazine](#)
 14. [PhysOrg.com](#)
 15. [Website gear](#)
 16. [Insciences](#)
 17. [Macsimunnews](#)
 18. [el Science News](#)
 19. [Topix](#)
 20. [RocketNews](#)
 21. [ScienceWeek](#)
 22. [Science Daily](#)
 23. [ACM TechNews](#)
 24. [Fred Palma](#)
 25. [suka \(tidak\) suka](#)
 26. [Science News Daily](#)
 27. [socialmedian](#)
 28. [Science Blips: Jadeite](#)
 29. [Science Blips: Apatite](#)
 30. [IndicThreads.com](#)
 31. [news.csdn.net](#) (in Chinese) or ([Google's translation](#)) or ([local pdf](#)).
 32. [Software Development Tools Directory](#)

33. [eWeek.com](#)
34. [IT Pub.net \(in Chinese\)](#) or ([Google's translation](#)) or ([local pdf](#)).
9. Kojo Nnamdi, "The Kojo Nnamdi Show", *Life Lesson's: Randy Pausch*, radio show on WAMU 88.5FM (Washington, DC) and some NPR stations, July 28, 2008, 1:43pm-2:00pm. [Also available online](#) and [my local mp3 copy](#).
10. Chris Douce, "Natural Programming Project," *Psychology of Programming Interest Group (PPIG) Newsletter*, January, 2008. <http://www.ppig.org/newsletters/2008-01.html>
11. Luca Chittaro, "THE DISAPPEARING DESKTOP. An interview with Jaime Teevan (Microsoft) and William Jones (Univ. Washington)", *Interattivo*, 06/04/08, (discusses Feldspar at the PIM workshop at CHI'2008), [html](#).
12. Olga Kharif, "Google's Orkut: A World of Ambition", [BusinessWeek.com](#), October 8, 2007. Reprinted at [MSNBC](#).
13. Virginia Gold, "ACM Names 34 Fellows for Contributions to Computing and IT", January 10, 2006. [html](#); and *ACM MemberNet*, Volume 4, Issue 6, January 2006. [html](#)
14. Ivanhoe Broadcast News, "Hi-Tech Typing", *Discoveries and Breakthroughs in Science*. (1:25 min. video and web story). October, 2005. [html](#)
15. Aaron Marcus, "When in Rome, do as the Romans do: HCII 2005 recap", *ACM Interactions*, Volume 12, Issue 6, November + December 2005. pp. 48 - ff. ("why were such luminaries as ... Brad Myers from Carnegie-Mellon University in attendance?") [html](#) or [local pdf](#)
16. Eric Smalley, "View from the High Ground: CMU's Brad Myers", *Technology Review News*, August 22, 2005. [html](#).
 - o Summarized by *ACM TechNews*, Volume 7, Issue 833: August 24, 2005. [html of the summary](#).
17. Alan Cohen, "Software Is Too Buggy and Unreliable," part of the special section on "The Ten Biggest Problems in Computing and How We'll Solve Them", *PC Magazine*, August 23, 2005. Vol. 24, no. 14, pp. 86-87. Also on [PCMag.com](#).
18. (TR Staff), "Write Steady", *Technology Review*, vol. 108, no. 8, August, 2005, p. 27. [html](#)
19. Anne Watzman, "Ko, Aung and Myers Win Best Paper Award At International Conference on Software Engineering". CMU Press Release. May 23, 2005. [html](#)
20. Anne Watzman, "Myers and Wobbrock to Showcase Projects At Microsoft Research Tech Fair 2005". CMU Press Release. April 27, 2005. [html](#) and [pictures](#)
21. Bongshin Lee, Mary Czerwinski, George Robertson, Benjamin B. Bederson. "Understanding Research Trends in Conferences using PaperLens," *Proceeding of the SIGCHI Conference On Human Factors In Computing Systems: CHI'2005*, Portland, Oregon, April 02 - 07, 2005. pp. 1969-1972. [pdf](#).
"For example, the most prolific author is Brad Myers who has published 41 papers.... For End User Programming, Brad Myers was the most frequently cited author.... For example, Card and Myers are connected indirectly to each other because they have each co-authored a paper with Shneiderman."
22. "Copy-and-paste goes natural", *Technology Research News*, January 12/19, 2005. [html](#).
23. ACM TechNews, "Taking Handheld Devices to the Next Level", Volume 7, Issue 744: Friday, January 21, 2005. [html](#)
24. Christine Tomasino, "[A Presenter's Friend](#)" and "[Handheld Software for Student Collaboration](#)". *For What It's \$\$Worth\$\$*. Friday, January 21, 2005.
25. Byron Spice, "Text with an edge," *Pittsburgh Post-Gazette*, Monday, Nov. 29, 2004. p. A-6. [html](#)
26. Aaron Ricadela, "Trying to Make the Pen as Mighty as the Keyboard," *The New York Times*, November 11, 2004. p. E5. [html](#)
27. "Home is where the future is", *The Economist*, Sep 16, 2004. Print edition and [on-line](#)
28. The "Knowledge Encapsulation System", a commercial product of [Software Theories](#), specifically references [our paper](#) as an influence.
29. Mike Crissey, "Researchers aim to make debugging simpler", Associated Press, July 26, 2004. Appears in [Salon.com](#) and [MSNBC](#) and [CNN](#) and [CBSNews.com](#) and [Forbes.com](#) and [USAToday.com](#), and [Detroit News \(August 15, 2004\)](#), and [Melbourne, Victoria, Australia Herald Sun](#), and [Gadgetopia](#), and [404 Magazine \(in German\)](#), etc.
30. Sebastian Rupley, "Debugging for the Masses", *PC Magazine Online*, May 14, 2004. [html](#). Reprinted in Yahoo News
31. David Hart, "Researchers to Help Exterminate Bugs in Spreadsheets, Web Applications." NSF Press Release NSF PR 04-065 - May 05, 2004. [html](#). Also reprinted in:

- [Innovations Report, May 06, 2004](#)
 - [Eureka!ert, May 5th, 2004](#)
 - [Newswise, May 5th, 2004](#)
32. Calvin Leske, "The Pittsburg Pebbles PDA Project" [sic], *The NSDL Scout Report for Math, Engineering, and Technology*. Volume 2, Number 19, September 26, 2003. [html](#)
 33. Mark Boslet, "THE BIG IDEA: Microsoft Labs Searches For Legacy," *Dow Jones Newswires*, 22 September 2003.
 34. Kim Peterson. "Inventions' wonderful world on display at Microsoft fair," *Seattle Times*. Wednesday, July 30, 2003. pp. E-1 and E-3. [html](#)
 35. Microsoft PressPass Press Release, "It's Academic: Microsoft Research Collaboration Projects Fuel Technology Innovation at Universities". Redmond, Wash., July 28, 2003. [html](#)
 36. Dan Gillmor, "Dan Gillmor: Designing new handhelds to improve human-computer interaction," *SiliconValley.Com; The San Jose Mercury News*, April 9, 2003. [html](#)
 37. Kimberly Patch, "Handhelds Gain Space," *Technology Research News*, February 26/March 5, 2003, p. 4. [html](#)
 38. Walter McKenzie, "PDAs in the Classroom," *Innovative Teaching Newsletter*, Vol. 5, no. 15, January 6, 2003, [html](#)
 39. Ann Light, "Pebbles Project connects PDAs up Smartly," *UsabilityNews.com*, 17 December 2002. [html](#)
 40. Michael Yeomans, "CMU Scientists Improving Computers' People Skills," *Pittsburgh Tribune-Review*, Tuesday, October 22, 2002. pages B7, B10. [html](#)
 41. Mike Crissey, "Designers Work on All-in-One Remote," *Associated Press*, August 27, 2002. [html](#)
 42. John Zyskowski, "Handhands in a new world order," *Federal Computer Week*, March 18, 2002. [html](#)
 43. Kimberly Patch, "Correction choices key for speech software," *Technology Research News*, September 5, 2001. [html](#)
 44. Catherine Zandonella, "How to Snarf with the Geeks," *The New Scientist*, vol. 172, no. 2311, October 6, 2001. p. 24.
 45. Anthony Violanti, "Revolution in a Box: How 20 years of Personal Computers changed the world," *Buffalo News*, August 12, 2001. pp. A1, A8.
 46. Jennie Borodko Stack, "Palm Pilot Connects Girl with Classroom," *QUEST*, Volume 8, Number 1, February 2001. pp. 48-49. [html](#)
 47. Paul Beebe, "Software Marketed to trade under CMU brand name," *Pittsburgh Tribune-Review*, vol. 112, no. 285, Nov. 14, 2000.
 48. Leander Kahney, "Prettying Up Linux," *Wired News*, Feb. 25, 2000. page 2. [html](#)
 49. Andrew Wilson. "Computer Conference Set to Make Programming Easier," *Allegheny Business News*, vol. 6, no. 20, Nov 27-Dec 11, 1991. p. A5, A7.
 50. "Look before you leap," *Computing*. June 13, 1991. p. 4.
 51. Laurent Belsie. "Picture This: Visual Programming," *The Christian Science Monitor*. March 13, 1991. p. 12. also printed as "Researchers simplify computer programming," in *Grand Rapids Press*, MI. May 2, 1991.
 52. Tony Durham. "Programming by Example and Interface Without Tears," *Computing*. April 7, 1988. pp. 22-23.
-

Professional Activities:

Chair:

- Vice-Chair, VL/HCC Conference Steering Committee, 2011-2012
- Chair, [SIGCHI Achievement Awards committee](#), 2010-2012.
- General Conference Chair, [IEEE VL/HCC 2011](#). IEEE Symposium on Visual Languages and Human-Centric Computing, September 18–22, 2011, Pittsburgh, PA.
- Corporate Sponsors Co-Chair, UIST'2008, UIST'2007.
- Co-Organizer, "[End-User Software Engineering](#)" Dagstuhl Conference, 18.02.07 - 23.02.07, Seminar

- 07081, Organizers: Margaret M. Burnett, Gregor Engels, Brad A. Myers, Gregg Rothermel
- Corporate Sponsors Chair, UIST'2006, UIST'2005, UIST'2004, UIST'2003, UIST'2002, UIST'2001, UIST'2000 and UIST'1999: the ACM Symposium on User Interface Software and Technology.
- Associate Chair, Product Design and Usability (PDU) Consortium, at Carnegie Mellon University, Pittsburgh, PA.
- Co-organizer, NSF Workshop on Creativity Support Tools, June 13-14, 2005. Radisson Barcelo Hotel in Washington, DC.
- Program Co-Chair (with Jamie Frankel, MERL), Human Computer Interaction Consortium (HCIC'04), Fraser, CO, 2004.
- Co-Chair, Human-Computer Interaction working group at the ACM & NSF Workshop on Strategic Directions in Computing Research, June 14-15, 1996.
- General Conference Chair for UIST'95: the ACM Symposium on User Interface Software and Technology.
- Video Chair, 1990 and 1992 ACM SIGCHI Conferences.
- Organizer, SIGCHI'91 two-day Workshop: Computer Languages for Programming User Interface Software, April 28-29, 1991.
- Displays Chair, 1988 IEEE Workshop on Visual Languages.
- Chair, ACM SIGCHI User Interface Magazine Committee, 1990-1991.

Editorial:

- Editorial Board, *Human-Computer Interaction Journal*, 1990-present.
- Computer Sciences Special Editorial Board of *Interacting with Computers*. 1996 - present.
- Associate Editor, *Journal of Visual Languages and Computing*, Academic Press. 1989 (Founding) - present.
- Guest co-editor, Special Issue of *IEEE Software* on End-User Software Engineering, September/October 2009.
- Guest co-editor, Special Issue of *ACM Transactions on Computer-Human Interaction (TOCHI)* on Web Accessibility, 2006.
- Associate Editor, *ACM interactions* magazine. 1993 (Founding) - 2007
- Associate Editor, *ACM Transactions on Computer-Human Interaction*. 1993 (Founding) - 2006
- Guest co-editor, Special issue on Handheld Computing of *IEEE Computer*, September, 2003.
- Editorial Board, *inScight*, Academic Press Daily Science News Service on the Internet, 1998.
- Associate Editor, *ACM Transactions on Information Systems*, 1991-1993.
- Advisory Editor, Jones and Bartlett Publishers, Inc. 1991-1993.
- Guest editor, Special issue on User Interface Software of *ACM Transactions on Information Systems*, July, 1990.

Program Committees:

- Program Committee, LIVE 2013: Workshop on Live Programming, at ICSE'2013, San Francisco, CA, May 19, 2013.
- Program Committee, IEEE Symposium on Visual Languages and Human-Centric Computing (VL/HCC), 2012, 2010, 2009.
- Program Committees, ACM SIGCHI Symposium on Engineering Interactive Computing Systems, EICS'2010, EICS'2009
- Organizing Committee, Software Engineering Foundations for End User Programming (SEEUP) Workshop at ICSE'2009.
- Program Committee, Second International Symposium on End User Development (IS-EUD'2009), March 2-4, 2009. Siegen, Germany.
- Program Committee, The Fourth Workshop on End-User Software Engineering (WEUSE IV), Co-located with ICSE 2008, Leipzig, Germany. May 12, 2008.
- Organizing Committee, Dagstuhl Seminar 07081, "End-User Software Engineering", M. M. Burnett, G. Engels, B. A. Myers, G. Rothermel. Schloss Dagstuhl International Conference And Research Center For

- Computer Science, Germany. Feb 18, 2007 - Feb 23, 2007.
- Organizing Committee, 2nd Workshop on End-User Software Engineering (WEUSE II) at CHI'2006, Montreal, Canada, April 23, 2006.
- Program Committee, Workshop on The Many Faces of Consistency in Cross-platform Design at CHI'2006, April 23, 2006, Montreal.
- Program Committee, 2005, 2000, 1990, and 1989 ACM Symposia on User Interface Software and Technology (UIST).
- Program Committee, 1st Workshop on End-User Software Engineering (WEUSE 2005) at ICSE 05, Saint Louis, MO, May 21st 2005.
- Program Committee, Third IEEE Symposium on End-User Programming and Domain Specific Programming, October 28-31, 2003, Auckland, New Zealand.
- Program Committee, MobileHCI'03: Fifth International Symposium on Human Computer Interaction with Mobile Devices and Services, Udine (Italy), 23-26 September 2003
- Program Committee, International Workshop on Visual Languages and Computing, VLC'03, Florida International University, Miami, Florida, September 24-26, 2003.
- Program Committee, CHI'2003 Workshop on Perspectives in End User Development.
- Program Committee, ICMI'2002: International Conference on Multimodal Interfaces.
- Program Committee, IUI'2002: International Conference on Intelligent User Interfaces (IUI), 2002.
- Program Committee, Shared Environments to Support Face-to-Face Collaboration Workshop at CSCW'2000.
- Program Committee, ADL'2000: IEEE Advances in Digital Libraries Conference, May 22-24, 2000, Washington, D.C.
- Program Committee, 4th USENIX Windows Systems Symposium. August 3-4, 2000, Seattle, Washington.
- Program Committee, DSL'99: 2nd Usenix Conference on Domain Specific Languages. Oct 6-9, 1999 in Austin, Texas.
- Doctoral Consortium Committee, 1997 ACM SIGCHI Conference.
- Short Papers & Interactive Posters: CHI'95.
- Videos: ACM CHI'91, and INTERCHI'93 Conferences.
- Papers: ACM SIGCHI+GI'87, CHI'89, CHI'91, and CHI'99 Conferences.
- Program: 1988, 1989 and 1990 IEEE Workshops on Visual Languages.
- Program: First (1990) and Second (1991) EUROGRAPHICS Workshops on Object Oriented Graphics.

Other Committees:

- ISAT/DARPA Fostering Adoption of Programming Languages Workshop, February 11-12, 2013, Philadelphia, PA
- Member, VL/HCC Conference Steering Committee, 2009-present
- Member of the International Advisory Board of the Master Program in Human Computer Interaction (HCI) at the University of Siegen, Siegen, Germany, 2009-present.
- IEEE Senior Member Review Panel, 2009
- Microsoft Consumer Productivity Experiences Group Advisory Council. 2006-2008.
- Microsoft Research University Relations Faculty Advisory Board. 2003.
- DARPA HCI Workshop, October 28-29, 1992, Pittsburgh, PA.
- DARPA ISAT Study Group: Gentle Slope Systems. August, 1992, Woods Hole, MA.
- DARPA ISAT Study Group: Intelligent Interfaces. August, 1991, Woods Hole, MA.
- NSF Workshop: An Agenda for Human-Computer Interaction Research: Science and Engineering Serving Human Needs. Washington, D.C. March 4-5, 1991.
- SIGCHI Publications Committee, 1989-1994.
- SIGCHI Committee on Flagship Publications, 1989-1990.

Reviewer:

- NSF Panel Reviewer (various programs), 1997, 2000, 2004, 2005, 2007, 2008.

- Grant proposals for the National Science Foundation (NSF) of the USA, SBIR program, and National Science and Engineering Research Council (NSERC) of Canada.
- Government of Quebec, Ministere du Conseil executif, Fonds de developpement technologique.
- Book manuscripts for Academic Press, Morgan-Kaufmann, Addison-Wesley, Prentiss-Hall, Benjamin Cummings, etc.
- Papers for: SIGCHI, SIGGRAPH, UIST, TOCHI, HCI, IwC, IEEE CG&A, IEEE Computer, IEEE Software, IEEE Transactions on Software Engineering, ACM TOG, HICSS, IJCAI, TOPLAS, The Visual Computer, Software Practice & Experience, etc.

Societies:

SIGCHI, ACM (Fellow), IEEE Computer Society, IEEE (Fellow), Electronic Frontier Foundation (EFF), American Association of University Professors (AAUP).

CMU Activities:

- SCS Faculty Reappointment and Promotion Committee, ad hoc member, 2012-2013.
 - Organizer for the HCI Seminar Series, 1992-1993, and 1999-present.
 - HCII Committee on Forming a Minor in HCI, 2012.
 - Faculty Senator: representing HCII, 2012 - present; representing Computer Science, 1994 - 1996.
 - Admissions Committee, HCI Institute's Master's Program, 1995-1996, 2009-2011.
 - Admissions Committee, HCI Institute's PhD Program, 1999-2003, 2009-2010.
 - Participant, Interdisciplinary Research Training Opportunities in Assistive Technology at CMU and the University of Pittsburgh (IGERT Program), 2003-2007.
 - Member, HCII Executive Committee, 2004-2009.
 - Marshall of the SCS Masters Students, CMU Commencement, May 20, 2007.
 - Co-Leader, (with Michael Boninger) of the Human-System Interaction Thrust of the Quality of Life Technology (QoLT) Engineering Research Center, 2005-2007
 - Member, Quality of Life Technology Engineering Research Center, (QoLT), 2005-2007.
 - Member, HCII Twelfth Anniversary Committee, 2005-2006.
 - Member, General Motors Collaborative Laboratory, 2003-2007.
 - Member, Center for Wireless and Broadband Networking, 2001-2006.
 - Member, MERITS of Pittsburgh: Medical Robotics and Information Technology for Medicine and Surgery, 2001-2005.
 - Faculty Judge, CMU first round of the Microsoft Imagine Cup Contest, April, 2004.
 - Facilities Advisory Committee for the School of Computer Science, 2002-2003.
 - Faculty sponsor for CMU's participation in the "ACM Quest for Windows CE Applications" contest, 1999, which won first place in the "Personal Productivity" team category.
 - PhD for HCI Students Committee, 1998-1999.
 - Steering Committee of the Human-Computer Interaction Institute, 1994-1997.
 - Developed the *Guide for New Faculty in the School of Computer Science*, August, 1993 and May, 1994.
 - CS Committee on Non-Tenured Reappointments and Promotions, 1993.
 - CS Faculty Hiring Committee, 1992-1994.
 - CS HCI Faculty Recruitment Coordinator, 1992-1994.
 - Member, School of Computer Science Policy Committee, 1992-1996.
 - Member, Computing Advisory Committee of the Faculty Senate, 1990-1992.
 - Organizer for the 1989-90 Programming Systems Seminar Series.
 - Faculty sponsor for CMU's participation in Apple Computer's 1987 "PC of the Year 2000" contest.
-

Teaching:

Courses

- 05-773A4: Computer Science Perspectives in HCI. Spring, mini 4, 2013
- 05-830: Advanced User Interface Software. Spring, 2013
- 05-863/08-763/46-863: Introduction to Human Computer Interaction for Technology Executives, Fall, Mini-2, 2012. 60 students.
- 95-763 Z5: Introduction to Human Computer Interaction for Technology Executives, Summer, Mini-5, 2012. (For the Heinz Executive Ed program). 12 students.
- 08-702, 08-703: Contextual Design, User Interface Design and Testing. For MSIT eBusiness program, Fall, 2012. 47 students.
- 05-671: Masters HCI Project, Spring, 2012. 51 students
- 05-863/08-763/46-863: Introduction to Human Computer Interaction for Technology Executives, Fall, Mini-2, 2011. 58 students.
- 08-702, 08-703: Contextual Design, User Interface Design and Testing. For MSIT eBusiness program, Fall, 2011. 48 students.
- 05-899D: Human Aspects of Software Development (HASD), Spring, 2011. 7 students for credit, plus 5 audit.
- 05-863/08-763/46-863: Introduction to Human Computer Interaction for Technology Executives. Fall, Mini 2, 2010. 65 students.
- 08-702, 08-703: Contextual Design, User Interface Design and Testing. For MSIT eBusiness program, Fall, 2010. 47 students.
- 05-671/672: Masters HCI Project. Spring/Summer, 2010. 12/48 units. 50 students.
- 05-863/08-763/46-863: Introduction to Human Computer Interaction for Technology Executives. Fall, Mini 2, 2009. 32 students.
- 08-702, 08-703: Contextual Design, User Interface Design and Testing. For MSIT eBusiness program, Fall, 2009. 24 students.
- 05-830: Advanced User Interface Software. Spring, 2009. 6 students.
- 05-863/08-763/46-863: Introduction to Human Computer Interaction for Technology Executives. Fall, Mini 2, 2008. 59 students.
- 08-702, 08-703: Contextual Design, User Interface Design and Testing. For MSIT eBusiness program, Fall, 2008. 38 students.
- 05-863/08-763/46-863: Introduction to Human Computer Interaction for Technology Executives. Fall, Mini 2, 2007. 39 students.
- 08-702, 08-703: Contextual Design, User Interface Design and Testing. For MSIT eBusiness program, Fall, 2007. 27 students.
- 05-671/672: Masters HCI Project. Spring/Summer, 2007.
- 08-702, 08-703: Contextual Design, User Interface Design and Testing. For MSIT eBusiness program, Fall, 2006. 32 students.
- 17-770 / 46-863: Introduction to Human Computer Interaction for Technology Executives. Fall, Mini 1, 2006. 12 students.
- 05-671/672: Masters HCI Project. Spring/Summer, 2006. 29 students.
- 96-766, 96-768: Contextual Design, User Interface Design and Testing. For MSIT eBusiness program, Fall, 2005. 28 students.
- 96-766, 96-768, 96-771: Contextual Design, User Interface Design and Testing. For MSIT eBusiness program, Fall, 2004. 40 students.
- 05-830: Advanced User Interface Software, Fall, 2004. 7 students.
- 20-790: Human-Computer Interaction for eCommerce. Summer Session Two, 2004. (Taught for the UTC Flex-Mode distance-ed program) 19 students.
- 20-790: Human-Computer Interaction for eCommerce. Mini-6, Summer Session Two, 2004. 31 students.
- 05-630 / 05-430: Programming Usable Interfaces, Spring, 2004. 18 grad, 18 undergrad students.
- 05-830: Advanced User Interface Software, Spring, 2003. 5 students.
- 96-766: CMU West Campus - Information Technology Masters of eBusiness Technology, Contextual Design, User Interface Design and Testing, Fall, 2002 and Spring 2003. 6 students.
- 20-790: Human-Computer Interaction for eCommerce. Spring, first mini, 2003. 12 students. (Taught for the UTC Flex-Mode distance-ed program)

- 20-790: Human-Computer Interaction for eCommerce. Fall, second mini, 2002. 25 students.
- Human-Computer Interaction in eCommerce. June 26 - August 9, 2002. 34 students.
- 20-790: Human-Computer Interaction for eCommerce. Fall, second mini, 2001. 32 students.
- 05-631 Software Architecture for User Interfaces, Fall, 2001. 13 students.
- Human-Computer Interaction in eCommerce. June 25 - August 10, 2001. 45 students.
- 05-830, Advanced User Interface Software, Spring, 2001. Enrollment: 15 (8 PhD, 4 MS, 3 undergrad)
- 05-830, User Interface Software, Spring, 2000. Enrollment: 8 (5 MS, 1 PhD, 2 undergrad)
- 05-689, Evaluating Usability of Pebbles (Independent Study), Summer, 1999. Enrollment: 4 MS HCII.
- 05-830, User Interface Software, Spring, 1999. Enrollment: 12 (3 MS, 2 PhD, 6 undergrad, 1 staff)
- 05-830, User Interface Software, Spring, 1998. Enrollment: 9 (4 MS, 1 PhD, 3 undergrad, 1 staff)
- 05-830, User Interface Software, Spring, 1997. Enrollment: 14 (5 MS, 5 PhD, 1 undergrad, 1 special)
- 15-621 and 15-499(A), Intro to User Interface Programming, taught with Dan Olsen, Fall, 1996. Enrollment: 20 (10 HCII MS, 10 undergrad).
- HCI2: HCI Software Tools, A one day short course in the Carnegie Mellon Summer School of Computer Science, June, 1996.
- 15-820 (B) Advanced Topics in HCI: User Interface Software, Spring, 1996. Enrollment: 12 (1 undergrad, 4 PhD, 4 MSE, and 3 INI MS).
- 17-698B and 15-499A, Introduction to User Interface Programming, taught with Jim Morris, Fall, 1995. Enrollment: about 15 undergrad, 3 HCII MS.
- 15-820(C) and 15-499(B), Advanced Topics in HCI: User Interface Software. Spring, 1994. Enrollment: about 18 undergrad and 2 MS.
- 15-810A: Topics in User Interface Software, Spring, 1989. Enrollment: about 20, none for credit.

Independent Study

- *Slideshow Commander on Blackberry*, Haijie Gu, Fall, 2009.
- *Slideshow Commander on iPhone*, Steven Chou, Fall, 2009.
- *Apatite*, Dan Eisenberg, Fall, 2008, Spring, 2009, Fall, 2009. *Winner, First place in the "Yahoo! Undergraduate Research Awards" competition at Carnegie Mellon University, May 6, 2009, and Honorable Mention for the CRA Outstanding Undergraduate Research Awards 2010.*
- *SAP API Studies*, Yingyu Xie (Clare), Sae Young (Sophie) Jeong, Spring, 2008.
- *Study of Designer's Expressions*, Sunyoung Park, Fall, 2007.
- *US version of Korean Cyworld*, Myung-Joo Ko, Fall, 2004.
- *Pebbles on Nokia Phones*, Ivan Gonzalez, Spring, 2004.
- *TA for 20-790*, Sue Young Chung, Summer, 2004.
- *Creating a Simulator for a General Motors Navigation System*, Pegeen Shen, Fall, 2003.
- *New Features for Pebbles PocketPC*, Yuhua Li, Fall, 2003.
- *Implementing USB in Pebbles*, Dave Kong, Spring, 2002.
- *Evaluating HANDS*, Luis J. Cota, Fall, 2001.
- *Evaluating the Silver Video Editor*, Rishi Bhatnagar, Summer, 2001.
- *Evaluating the use of handhelds for the handicapped*, Sunny Ya-Ting Yang and Brian Yeung, Spring, 2001.
- *Evaluating the Usability of the Hands Language*, Leah Miller, Spring, 2001.
- *Using Laser Pointers in Meetings*, Choon Hong Peck, Fall, 2000 and Spring, 2001.
- *Personal Universal Controller*, Marc Khadpe, Summer, 2000.
- *Design for the Hands Language for Children*, Ruben Carbonell and Joonhwan Lee, Spring, 2000.
- *Evaluating Floor Control for Small Groups with Palms*, Yu Shan Chuang and Marsha Tjandra, Spring, 2000.
- *Evaluation Natural Expression of Algorithms*, Aristiwidya B. Hardjanto ("IKA"), Spring, 1999.
- *Using the PalmPilot in Meetings*. Herbert Stiel, Fall, 1997, Undergrad CS.
- *Networking in Amulet*. John Huebner, Summer and Fall, 1997, MSE.
- *Interactive Specification of Constraints*. Ilhwan Kwon, Spring and Summer, 1997. Undergrad ECE.
- *The Design of the Atacama Desert Trek Interface*. Jennifer Gutwacks and Clark Slater, Spring, 1997. MS HCI.
- *Natural Programming*. John Chang, Spring, 1997. Undergrad CS.

- *Interface Builder for Amulet*. William Moher, Spring, 1996. Undergrad CS.
 - *Interpreting Football Plays Sketched by Demonstration*, Patrick Rogan, Spring, 1996. Undergrad Psychology.
 - *Creating Macintosh Games by Example*, Andrew Tepper, Spring, 1989, Undergrad CS.
-

Students:

PhD Students

- Erik Harpstead
- YoungSeok Yoon
- Kerry Shih-Ping Chang
- Stephen Oney
- Thomas LaToza. PhD, May, 2012, *Answering Reachability Questions*. [pdf](#). Currently, PostDoc at University of California at Irvine.
- Jeffrey Stylos. PhD, May, 2009, *Making APIs More Usable with Improved API Designs, Documentation and Tools*. [pdf](#).
- Andrew Ko. PhD, May, 2008, *Asking and Answering Questions about the Causes of Software Behavior*. [pdf](#). Currently, Assistant Professor at University of Washington.
- Jeff Nichols. PhD, December, 2006, *Automatically Generating High-Quality User Interfaces for Appliances*. [pdf](#). Currently, Research Staff Member at IBM's Almaden Research Center.
- Jake Wobbrock. PhD, August, 2006, *EdgeWrite: A Versatile Design for Text Entry and Control*. [Abstract and PDF](#). Winner, 2007 SCS Dissertation Award. Currently, Assistant Professor at University of Washington.
- Rob Miller. PhD, May, 2002, *Lightweight Structure in Text*. [PDF](#). Thesis won SCS Doctoral Dissertation Award for 2002 and ACM Doctoral Dissertation Award Honorable Mention. Currently, Associate Professor at MIT.
- John Pane. PhD, May, 2002. [A Programming System for Children that is Designed for Usability](#). Currently at Rand Corporation.
- Rich McDaniel. PhD, May, 1999, *Building Whole Applications Using Only Demonstration*. Currently at Siemens Corporate Research, Princeton, NJ.
- James Landay. PhD, Dec. 1996, *Interactive Sketching for the Early Stages of User Interface Design*. Currently, Short-Dooley Professor at Univ. Washington.
- Francesmary Modugno. PhD, May, 1995, *Extending End-User Programming in a Visual Shell With Programming by Demonstration and Graphical Language Techniques*. Currently, Assistant Professor, Department of Epidemiology, University of Pittsburgh

Masters Students

- Michael Coblenz, MS in CS, August, 2006, *JASPER: Facilitating Software Maintenance Activities With Explicit Task Representations*. [Abstract](#), [pdf](#).
- Andrew Faulring, MS in CS, December, 2005.
- Rajesh Seenichamy, MS in INI, August, 2003, *Communicating With X-10 And Vehicle Functions To Enable Two-Way Remote Control*.
- Juan Casares, MS in HCI, May 2002.
- Nobuhisa Yoda, MS in CMU's Information Networking Institute, Dec, 1994: *An Architectural Design of A Toolkit for Synchronous Groupware Applications*.
- David Kosbie. MS CSD.
- Andrew Werth, MS in INI, Oct. 1992, *Tourmaline: Formatting Document Headings by Example*.

CSD BS Thesis Students

- Ivan Gonzalez, BS, May, 2006. *Thumb Based Interaction Techniques for Input on a Steering Wheel*
- Michael Coblenz, BS, May, 2005. *Using Objects of Measurement to Detect Spreadsheet Errors*. CMU-CS-05-150, CMU-HCII-05-102. [Abstract](#), [pdf](#).
- Andrew Faulring, BS, May, 1999. *Gold: Charting by Demonstration*
- Chotirat ("Ann") Ratanamahatana, BS, May, 1998. *A Textual Programming Language and Environment for Beginners*
- Rajan Parthasarathy, BS, May, 1994, *Garnette: An Interactive User Interface Tool*.

CMU SCS PhD Thesis committee

- Larry Maccherone (ISR PhD in progress)
- Joshua Sunshine (ISR PhD in progress)
- Leong Hwee Teo (HCII PhD, 2011), "Modeling Goal-Directed User Exploration in Human-Computer Interaction". [pdf](#)
- Marwan Abi-Antoun (ISR PhD, 2009)
- Uri Dekel (ISR PhD, 2009)
- Chris Scaffidi (ISR PhD, 2009)
- Michael Gleicher (PhD CSD, 1994)
- Dean Rubine (PhD CSD, 1991)
- Tom Lane (PhD CSD, 1990)

External member, Thesis committee

- Doug Wightman, (PhD in progress, School of Computing, Queen's University, Canada)
- Xiang Cao (PhD in Computer Science, University of Toronto, 2008)
- Peter Tandler, (PhD, 2004, Computer Science, Darmstadt University of Technology, Germany)
- Jan Reinhardt, (PhD, 2003, Civil and Environmental Engineering, Carnegie Mellon University)
- Sailesh Panchang, (MS, 2002, Dept. of Rehabilitation Science and Technology, University of Pittsburgh)
- Linda McIver, (PhD, 2001, in Computer Science, School of Computer Science and Software Engineering, Monash University, Australia)
- Bernhard Suhm (PhD, 1998, University of Karlsruhe, Germany)
- T. Paul McCartney (PhD, 1996, Washington University in St. Louis, Computer Science Department)
- Martin R. Frank (PhD, 1995, Georgia Institute of Technology, College of Computing).
- David Maulsby (PhD, 1994, University of Calgary, Department of Computer Science)
- David Kurlander (PhD, 1993, Columbia University, Computer Science Department)

Visitors Supervised:

- Christian Doerner, Postdoc (Humbolt Scholar), 2010-2011.
- A. Chris Long, Postdoc, 2001-2002.
- Prof. Yoshihiro Tsujino, Department of Information and Computer Sciences, Osaka University, May, 1996 to March, 1997.
- Alex Klimovitski, November, 1994 to April, 1995.
- Keiji Kojima, Hitachi, October, 1990 to June, 1991.
- Osamu Hashimoto, NEC Corporation, July, 1990 to August, 1991.
- Brad Vander Zanden, Postdoc, August, 1988 to July, 1990.
- Philippe Marchal, 1987 to 1988

Invited Presentations:

Keynote Talks:

1. Opening Keynote Speaker, British HCI 2013 Conference, London, England, Sept 11, 2013.
2. Keynote speaker, 21st IEEE International Conference on Program Comprehension ([ICPC2013](#)), San Francisco, CA, May 20-21, 2013.
3. Opening Keynote, [SEIF 2012 Day](#), (annual Software Engineering Innovation Foundation (SEIF) Workshop of Microsoft Research), July 18, 2012, Redmond, Washington. "Improving Software Development through Human-Centered Approaches." See [pdf of talk slides](#).
4. Keynote speaker, Workshop on the Evaluation and Usability of Programming Languages and Tools ([PLATEAU](#)) 2011, with the Onward!2011 and Splash 2011 conferences in Portland, Oregon, October 24, 2011. "Inherent vs. Accidental vs. Intentional Difficulties in Programming". [pdf of slides](#).
5. Keynote speaker, the ACM SIGCHI Symposium on Engineering Interactive Computing Systems ([EICS'2009](#)), Pittsburgh, PA, July 14-17, 2009. "Engineering More Natural Interactive Programming Systems". [pdf of talk slides with references](#)
6. Opening Invited Speaker, IBM Almaden's "New Paradigms for Using Computers" Workshop on The Future of Design and Software Development ([NPUC2009](#)), July 9, 2009, San Jose, CA, "End-User Design and Development". [video of the talk](#), or [another video of the talk](#)
7. Dinner keynote speaker, [Accel 2008](#), Vocollect's Global Conference on Voice in the Supply Chain. Pittsburgh, PA, April 14-16, 2008. "User Interfaces of the Future"
8. Keynote speaker, AAAI 2007 Spring Symposium on [Interaction Challenges for Intelligent Assistants](#), 26-28 March 2007, Stanford University, CA. "A User Acceptance Equation for Intelligent Assistants". [Abstract](#) and [pdf of PowerPoint slides](#).
9. Invited Research Overview, "End-User Programming". CHI 2006, April 22-27, 2006, Montreal, Canada.
10. Keynote speaker, [Third International Conference On Mobile And Ubiquitous Multimedia](#), MUM2004, October 27 - 29, 2004, College Park, Maryland. "Mobile Devices for Control of Ubiquitous Multimedia".
11. Keynote speaker, [The Seventh ACM SIGPLAN International Conference on Functional Programming](#), ICFP 2002. October 4-6, 2002, in Pittsburgh, PA. "Towards More Natural Functional Programming Languages."
12. Keynote speaker, [The Fourth Symposium on Human-Computer Interaction for Mobile Devices](#), Mobile HCI'02. September (18-20) in Pisa, Italy. "Mobile Devices for Control."
13. Keynote speaker, [IEEE Symposium on Visual Languages](#), VL'2000, Seattle, Washington, September 10-14, 2000. "Creating More Natural Programming Languages."
14. Keynote speaker, 14th Triennial Congress of the International Ergonomics Association, in conjunction with the 44th Annual Meeting of the Human Factors and Ergonomics Society. July 30 - August 4, 2000, San Diego, CA. "Past, Present and Future of User Interface Software Tools"
15. Keynote speaker, DSL'99: 2nd Usenix Conference on Domain Specific Languages, Austin, TX, October 3-6, 1999. "Towards More Natural Domain-Specific Languages."
16. Keynote speaker, ACM Multimedia 97 conference. Nov 11-13, 1997 in Seattle, WA. "Authoring Interactive Behaviors."
17. Keynote speaker, HCI '91: The British Computer Society Specialist Group in HCI Annual Conference, Aug 21, 1991, Edinburgh, UK.
18. Keynote speaker, 1990 IEEE Conference on Visual Languages, Chicago, Ill, October 6, 1990.
19. Keynote speaker, "The State of the Art in Visual Programming and Program Visualization," The British Computer Society Computer Graphics and Displays Group, International State of the Art Symposium on *Graphics Tools for Software Engineering: Visual Programming & Program Visualization*. London, England. March 16, 1988.

Other Talks and Colloquia:

1. CSE Colloquium Speaker, "Improving Software Development through Human-Centered Approaches", Computer Science & Engineering, University of Nebraska–Lincoln, Lincoln, NE, January 10, 2013. [Talk announcement](#).
2. Invited speaker, SAP Labs seminar, Palo Alto, CA, July 25, 2012, "Improving SAP's Development Tools and APIs through Human-Centered Approaches"
3. Invited "Lightening Talk" speaker, [SEIF 2012 Day](#), (annual Software Engineering Innovation Foundation (SEIF) Workshop of Microsoft Research), July 18, 2012, Redmond, Washington. "Better Tools for Authoring Interactive Behaviors for the Web"

4. Invited Speaker, [China Symposium on Human Computer Interaction](#), sponsored by ACM SIGCHI China Chapter and Microsoft Research Asia, Beijing, China, June 18-19, 2012, "Programmers are People Too: Applying HCI to Software Developers"
5. Invited speaker, Software Engineering Horizons track of [ICSE 2012](#), the 34th International Conference on Software Engineering, (one of five invited speakers in 2012). Zurich, Switzerland, June 2-9, 2012. "Software Engineers are People Too: Applying Human Centered Approaches to Improve Software Development." See [pdf of slides](#).
6. Google Tech Talk, Pittsburgh, PA, 3/6/2012, "Improving APIs using HCI Techniques".
7. HCII Seminar Series, Carnegie Mellon University, 2/01/12, "HCI and Intellectual Property"
8. Invited speaker, ETH Zurich [Computer Science Colloquium](#), "[Improving the Usability of Programming Languages and Environments](#)," Informatik (Computer Science), Swiss Federal Institute of Technology, Zurich, Switzerland, October 3, 2011.
9. Discussion Group Speaker, "Unraveling the Mystery of Today's Computer Terminology - Terms Like Facebook, Twitter, Texting, WiFi, YouTube, etc.," Rodef Shalom Levy Hall, Pittsburgh, PA, February 11, 2010.
10. Invited speaker, (Given by Jeff Stylos) [3rd Annual SAP Sponsored Academic Research Conference](#), Mountain View, CA, "API Usability for Web Services", August 21, 2009.
11. Special USER Seminar, IBM Almaden Research Labs, "More Natural Programming Through User Studies", San Jose, CA, July 10, 2009.
12. Invited speaker, SAP Labs seminar, Palo Alto, CA, "More Natural Programming Through User Studies", July 8, 2009.
13. Invited speaker, CreativeIT Principal Investigators Meeting and Exhibition, January 15-16, 2009, NSF, Arlington, VA
14. Invited speaker, [DGPis40: Scientific Workshop & 40th Anniversary Reunion](#), University of Toronto, May 28-30, 2008. [video of talk](#) (1hr, 10min)
15. Invited speaker, Fourth Workshop on End-User Software Engineering (WEUSE IV) In conjunction with ICSE 2008, "End-User Tools for Creating Dependable Software", May 12, 2008, Leipzig, Germany
16. CS547: Stanford University Human-Computer Interaction Seminar on People, Computers, and Design, September 28, 2007, Palo Alto, CA. "More Natural Programming Through User Studies". [Talk announcement](#) and [streaming video of the full talk](#) (1hr24min).
17. Google Technical Seminar, "Update on the Natural Programming Project", September 26, 2007, Mountain View, CA. [Google Video \(1 hr\)](#)
18. Invited speaker, with Larry Masinter, at the Adobe Principal Scientist Council Briefing: "Survey: Past and Current Art of Making Programming Easier." San Francisco, CA. June 26, 2007.
19. Invited speaker, [SAP Academic Symposium](#), June 7, 2007, Mountain View, CA, "API Usability"
20. Distinguished Lecture Series, Department of Computer Science, University of Illinois at Urbana-Champaign, "More Natural Programming Through User Studies", April 9, 2007.
21. Invited speaker, SAP Labs seminar, Palo Alto, CA, "More Natural Programming Through User Studies", March 28, 2007.
22. Celebrity Judge, at "[Usability Game Show - Pittsburgh](#)" as part of [World Usability Day](#), November 14, 2006.
23. Colloquium, Brown University Department of Computer Science, "More Natural Programming Through User Studies", November 2, 2006.
24. EUSES Consortium Workshop: End Users Shaping Effective Software, "Report of the CMU Natural Programming Group". Lincoln, Nebraska, October 25-27, 2006 and October 5-7, 2005.
25. Accenture. "More Natural Programming Through User Studies", September 8, 2006. Chicago, IL.
26. Google Technical Seminar, "More Natural Programming Through User Studies", October 27, 2005, Mountain View, CA.
27. Carnegie Mellon West, "Great Product Innovations" Speaker Series, "How the Human Interface Can Make or Break Great Product Innovations," October 27, 2005, Moffet Field, CA.
28. Microsoft Research Faculty Summit 2005, "Visions of Mobile Devices Beyond Their Current Role" in the session on "Enhanced Computing with Mobile Devices". July 19, 2005.
29. "Overview of Computer Science Support for Creativity" (with Randy Pausch) at [NSF Workshop on Creativity Support Tools](#), June 13-14, 2005. Radisson Barcelo Hotel in Washington, DC.
30. Microsoft Research Seminar, June 2, 2005. Redmond, WA. "More Natural Programming Through User

Studies".

31. "End Users in End-User Software Engineering: Where HCI Cross Cuts SE", at the 1st Workshop on End-User Software Engineering ([WEUSE 2005](#)) at ICSE 05, Saint Louis, MO, May 21, 2005.
32. "University Relations--Mobile Computing and User Interface Research," at the Microsoft Research Tech Fair, April 27, 2005, Library of Congress, Washington, D.C. ([some pictures with Congressmen](#))
33. EUSES Consortium Workshop: End Users Shaping Effective Software, "Project Marlalade". Pittsburgh, PA September 8-10, 2004.
34. Microsoft Research Seminar, August 4, 2004. Redmond, WA. "Review of Recent Research: Citrine Smart Clipboard, WhyLine Interrogative Debugging, EdgeWrite Text Entry, and Pebbles PocketPC Software".
35. [HCIL Seminar Series](#), University of Maryland, College Park, MD. October 21, 2003. "Mobile Devices for Control."
36. University of New Orleans, LA, September 12, 2003. "Mobile Devices for Control."
37. Microsoft Research Seminar, July 30, 2003. Redmond, WA. "An Update on the Pebbles Project: PocketPCs, Smartphones and TabletPCs for Universal Remote Control and A New Input Method for Small Devices".
38. Microsoft Research Faculty Summit 2003, Innovation Excellence Plenary Session, July 28, 2003, and DemoFest session, July 29, 2003, "Mobility: Handhelds for Universal Remote Control".
39. MIT AI Lab, [HCI Seminar Series](#), May 9, 2003, "[Mobile Devices for Control](#)"
40. Mitsubishi Electric Research Laboratory, May 8, 2003, Cambridge, MA. "Mobile Devices for Control."
41. CS547: Stanford University Human-Computer Interaction Seminar on People, Computers, and Design, November 22, 2002, Palo Alto, CA. "Mobile Devices for Control". [Talk announcement](#) and [streaming video of the full talk \(1hr26min\)](#). (*Warning: video link crashes Netscape 4.7*)
42. [CMU Tech Bytes](#) Seminar, Sheraton Palo Alto, Palo Alto, CA. Nov. 21, 2002. "Mobile Devices for Control".
43. Invited Speaker, Workshop on [End-User Development](#) of the European Community Network of Excellence. Sept. 23, 2002. Pisa, Italy. "Making Programming Easier by Making it More Natural."
44. Microsoft Research Seminar, July 31, 2002. Redmond, WA. "PocketPCs as Controllers for Computers and Appliances; Update on The Pebbles Project"
45. Invited speaker, InterNational Committee for Information Technology Standards (INCITS) Technical Committee [V2 Meeting](#), June 27, 2002, Minneapolis, MN. "Pebbles PUC Automatic UI Generation Project."
46. Invited speaker, [State University of New York Technical Conference 2002](#). Educational Technology Officers Association. June 17 - 19, 2002. Hudson Valley Resort Convention Center in Kerhonkson, NY. "The Pebbles Project General Overview: Using Hand-Held Computers and PCs Together" and "Using Handhelds to Enhance Classrooms and to Help the Handicapped"
47. Computer Science Colloquium Series, Kent State University, Kent, OH. February 20, 2002. "The Pebbles Project: Using Hand-Held Computers and PCs Together"
48. Guest speaker, [Pittsburgh Pocket PC User Group](#), February 6, 2002. Pittsburgh, PA. "The Pebbles Project: Using Hand-Held Computers and PCs Together"
49. Guest speaker, Ohio State University Dept. of Computer and Info. Science, Columbus, Ohio, August, 7, 2001, "The Pebbles Project: Using Hand-Held Computers and PCs Together."
50. Invited speaker, [Grid on the Go](#), May 20-22, 2001, NCSA, University of Illinois at Urbana-Champaign. "Using Wireless Handheld Devices in the Classroom, Office and Home."
51. Microsoft Research Seminar, April 6, 2000. Redmond, WA. "Update on The Pebbles Project: Using a Handheld as a Personal Universal Controller and to Augment a Laser Pointer in Meetings"
52. HCI Seminar Series, Carnegie Mellon University, 2/07/01, "Using Hand-Held Computers and PCs Together: The Pebbles Project"
53. Symbol Technologies, Inc. lunchtime presentation, August 25, 2000. Pittsburgh, PA. "The Pebbles Project: Using Hand-Held Computers and PCs Together"
54. Microsoft Research Seminar, August 2, 2000. Redmond, WA. "Using Windows CE Computers in Classrooms; and Public-Private Data Sharing Using a PC and PocketPCs; Update on The Pebbles Project"
55. Microsoft Research Seminar, December 7, 1999. Redmond, WA. "Towards More Natural Programming Languages".
56. HCI Seminar Series, Carnegie Mellon University, 11-17-99, "Using Handheld Computers and PCs Together". Click [here](#) to see a video of this talk.

57. Computer Science Colloquium, Brown University, Nov. 4, 1999. "Using Hand-Held Computers and PCs Together."
58. Invited speaker, IFIP Working Group 2.7/13.4 (User Interface Engineering), May 13, 1999, Pittsburgh, PA. "The Architectural Issues in Amulet."
59. Invited speaker, Human Computer Interaction Consortium (HCIC'99), Fraser, CO, Feb 3-9, 1999, "Prospects and Visions for User Interface Software Tools."
60. Invited speaker, The Ninth Annual NEC Research Symposium: Human Centric Multimedia Community, Nara, Japan, Aug. 30-Sept. 1, 1998.
61. Boeing Shared Services, Seattle, WA. June 17, 1998, "Amulet: Comprehensive Support for Graphical, Highly-Interactive User Interfaces"
62. Microsoft Research, Redmond, WA. June 15, 1998, "Collaboration Using Multiple PDAs Connected to a PC"
63. Invited speaker, CHI-Squared, The Chicago CHI Local Group, Chicago, IL, June 9, 1998.
64. Colloquium speaker, Lucent Labs, Naperville, IL, June 9, 1998. "Using PalmPilots Synchronously in Meetings."
65. Invited speaker, Human Computer Interaction Consortium (HCIC'98), Fraser, CO, March 4-8, 1998. "Natural Programming for Knowledge Management."
66. Colloquium speaker, IBM Thomas J. Watson Research Center, Hawthorne, NY, February 13, 1998. "Using PalmPilots Synchronously in Meetings."
67. Distinguished Lecture Series, University of Tennessee, Knoxville, TN, Nov. 3, 1997.
68. Colloquium speaker, Electric Boat Division of General Dynamics, Groton, Conn, May 1, 1997.
69. Invited speaker at the AAAI Spring Symposium on "Acquisition, Learning and Demonstration: Automating Tasks for Users", presented overview of "Demonstrational Interfaces." Stanford, CA, March 25-27, 1996.
70. Computer Science Colloquium, Washington University in St. Louis, MO, January 19, 1996.
71. Distinguished Lecture Series, University of Maryland, College Park, MD, February 28, 1995.
72. Invited Speaker, Software Engineering Tools and Techniques Conference, Los Angeles, CA, February 24 1995.
73. Distinguished Lecture Series, University of Toronto, Toronto, Canada, December 6, 1994.
74. Colloquium speaker, Toronto Computer Human Interaction (TORCHI) society, Toronto, Canada, December 5, 1994.
75. Distinguished Lecture Series, University of York, Toronto, Canada, February 11, 1994.
76. ARPA Workshop on HCI Architecture and Toolkits, 11-14 January, 1994, San Diego, CA.
77. Colloquium speaker, Georgia Tech, Atlanta, GA. July 28, 1993.
78. Colloquium speaker, University of Virginia, Charlottesville, VA. February 24, 1992.
79. Invited Speaker, "Workshop on Programming by Example," sponsored by Apple Computer Inc., March 11-12, 1992. Cupertino, CA.
80. Lecturer, "Extending Direct Manipulation: Demonstrational Interfaces and User Interface Development Environments," User Interfaces Strategies'92, A live Satellite TV Broadcast, from the University of Maryland, December 12, 1991.
81. Colloquium speaker, Xerox Palo Alto Research Center, Palo Alto, CA. June 20, 1991.
82. Colloquium speaker, Adobe Systems, Inc., Mountain View, CA. June 20, 1991.
83. Colloquium speaker, Hewlett Packard Software Engineering Systems. Sunnyvale, CA. January 29, 1991.
84. Colloquium speaker, Apple Computer, Inc. Cupertino, CA. January 28, 1991.
85. Colloquium speaker, Waterloo University, Waterloo, Ontario, Canada, November 14, 1990.
86. Colloquium speaker, Lotus Corporation, Cambridge, MA, November 7, 1990.
87. Colloquium speaker, Siemens Corporate Research, Princeton, New Jersey, May 14, 1990.
88. Visiting Distinguished Engineer under the IBM Visiting Scholar Program, Northeastern University, Department of Industrial Engineering and Information Systems, April 19, 1990.
89. Colloquium speaker, University of Toronto, Toronto, Ontario, Canada, August 8, 1989.
90. Colloquium speaker, Boeing Corporation, Seattle, WA, July 17-18, 1989.
91. Colloquium speaker, Microsoft Corporation, Seattle, WA, Dec. 5-6, 1988.
92. Invited speaker, The Toronto Exxperience; A Conference Celebrating Twenty Years of Computer Science Research at the University of Toronto. Toronto, Canada. May 9-13, 1988.
93. Invited speaker, AAAI Workshop on Architectures for Intelligent Interfaces. March 29-April 1, 1988. Monterey, CA.

94. Colloquium speaker, Department of Computer Science, York University, York, England. March 18, 1988.
95. Colloquium speaker, Department of Computer Science, University of Glasgow, Glasgow, Scotland, Great Britain. March 17, 1988.
96. Colloquium speaker, Department of Computer Science, Queen Mary College, London, England. March 17, 1988.
97. Colloquium speaker, Department of Computer Science, Rensselaer Polytechnic Institute, Albany, New York. January 28, 1988.
98. Colloquium speaker, Department of Electrical Engineering and Computer Science, The George Washington University, Washington, D.C. October 14, 1987.
99. Invited speaker, *ACM SIGGRAPH Workshop on Software Tools for User Interface Development*. Seattle, Washington. November 17-19, 1986.
100. Invited speaker, *Alvey MMI Workshop on Window Management*. Abingdon, Oxfordshire, England. April 29-May 1, 1985.

Tutorials:

- "User Interface Tools," tutorial #36 presented at *CHI'94*. Boston, MA. April 24-28, 1994.
- "User Interface Tools," tutorial #27 presented at *INTERCHI'93*. Amsterdam, The Netherlands. April 24-29, 1993.
- "The State of the Art in User Interface Development Environments," tutorial presented at HCI '91: The British Computer Society Specialist Group in HCI Annual Conference, Aug 20, 1991, Edinburgh, UK.
- "Visual Computing Environments," tutorial #23 presented at *SIGCHI '90*. Seattle, WA, April 1-5, 1990.
- "User Interface Design and Implementation," March 26, 1990 at Carnegie Group, Inc., Pittsburgh, PA.
- "Visual Computing Environments," tutorial #17 presented at *SIGGRAPH '89*. Boston, MA, July 31-August 4, 1989.
- "Visual Computing Environments," tutorial #14 presented at *SIGCHI '89*. Austin, Texas, April 30-May 4, 1989.
- "Human-Computer Interaction Technologies and Techniques," tutorial #11 presented at *SIGCHI '88*. Washington, D.C. May 15-19, 1988.
- "Workshop on Visual Programming" at Xerox EuroPARC, supported by Rank Xerox and Apple Computer in association with the British Computer Society Displays and HCI Specialist Groups. Cambridge, England. March 15, 1987.
- "Human-Computer Interaction: Selected Theories, Technologies and Techniques," tutorial #21 at *SIGGRAPH '87*. Anaheim, CA. July 27-31, 1987.

Panels:

- Panelist, "Studying API Usability for Enterprise Service-Oriented Architectures (eSOA)" in the panel on "Support for the Uptake of User-Developed-Services - Business Versus Community Models", *VL/HCC'2010*, 24 September, 2010, Leganes-Madrid, Spain.
- Invited panelist, "The Role of Interactive Systems in Universal Access," NSF Interactive Systems Grantees Workshop: ISGW '97, August 17-19, 1997, Stevenson, Washington.
- Panelist, "Model-based User Interfaces: What is it and why should I care?" *ACM Symposium on User Interface Software and Technology, UIST'94*, November, 1994. Los Angeles, CA.
- Panelist, "From Research Prototypes to Usable, Useful Systems: Lessons Learned in the Trenches," *ACM Symposium on User Interface Software and Technology, UIST'93*, November 3-5, 1993. Atlanta, GA.
- Organizer and Panelist, "Heuristics in Real User Interfaces," *INTERCHI'93*, Amsterdam, The Netherlands. April 24-29, 1993.
- Organizer and Panelist, "User Interface Design Tools," *1991 Lisp Users and Vendors Conference*, Gaithersburg, MD, Oct 28-Nov 1, 1991.
- Panelist, "HCI: Past and Future," *HCI '91: The British Computer Society Specialist Group in HCI Annual Conference*, Aug 23, 1991, Edinburgh, UK.
- Moderator and Panelist, "Demonstrational Interfaces, Coming Soon?" *SIGCHI'91*, New Orleans, LA. April 28-May 2, 1991.

- Panelist, "Direct Manipulation or Programming: How Should We Design Interfaces?" *ACM Symposium on User Interface Software and Technology, UIST'89*, Williamsburg, VA, Nov. 13-15, 1989.
- Moderator and Panelist, "User Interface Toolkits: Present and Future," *SIGGRAPH '88*, Atlanta, GA, August 1-5, 1988.
- Panelist, "Software Tools for User Interface Management," *SIGGRAPH '87*. Anaheim, CA. July 27-31, 1987.
- Panelist, "The Future of Window Systems," *SIGGRAPH '86*. Dallas, Texas. August 18-22, 1986.
- Panelist, "User Interface Management Systems," *Graphics Interface '84*. Ottawa, Ontario. May 28-June 1, 1984.

Invited Participation in Workshops:

(when not a speaker or organizer)

- Google Faculty Summit, July 25-27, 2012, Mountain View, CA
- Microsoft Research Faculty Summit, July 16-17, 2012, Redmond, WA
- Microsoft Research Faculty Summit, July 18-20, 2011, Redmond, WA
- CCC/CRA Interactive System Architecture Workshop, August 11-13, 2010, Jackson Hole, Wyoming
- Second North American SAP Academic Research Conference: Academic Innovation and Enterprise Applications, August 25, 2008, Mountain View, California
- CHASE 2008: Cooperative and Human Aspects of Software Engineering, Workshop at ICSE'2008. Tuesday, 13 May 2008. Leipzig, Germany
- "Adobe Education Designer and Developer Conference", March 2-4, 2008. San Francisco, CA
- "2007 Summer Institute on the Human Side of Software Development", co-sponsored by the University of Washington and Microsoft Research. August 12-17, 2007, Skamania Lodge, Stevenson, WA.
- Microsoft Research Faculty Summit, July 16-17, 2007, Redmond, WA
- "NSF Human-Centered Computing (HCC) Workshop", Arlington, Virginia, September 18-19, 2006
- Microsoft Research Faculty Summit, July 16-18, 2006, Redmond, WA
- Microsoft Research Faculty Summit, August 2-3, 2004, Redmond, WA
- "User Interfaces that Span Hand-Held and Fixed Devices," CHI'2001 Workshop on Distributed and Disappearing User Interfaces in Ubiquitous Computing, Seattle, WA, March 31-April 1, 2000.
- "Future Mobile Device User Interfaces" at CHI'2000, April 1, 2000. The Hague, The Netherlands. Matthias Schneider-Hufschmidt, organizer.
- "Handheld CSCW Workshop at CSCW'98," Seattle, November 14. Hans Gellersen and Albrecht Schmidt, organizers. <http://www.teco.edu/hcscw/>
- "CHI 98 Workshop On Learner-Centered Design," April 20, 1998. Sherry Hsi and Elliot Soloway, organizers.

Discussant:

- "Automated Selection of Remote Control User Interfaces in Pervasive Smart Spaces," by Nirali Desai, Khomkrit Kaowthumrong, John Lebsack, Nishant Shah, Richard Han. Human Computer Interaction Consortium (HCIC'02), Fraser, CO, Jan 30-Feb 3, 2002.
- "The Next Generation of Ubiquitous Computing," by Gregory Abowd and Elizabeth Mynatt. Human Computer Interaction Consortium (HCIC'99), Fraser, CO, Feb 3-9, 1999.
- "Tools and Environments for U.I. Design," SIGCHI'89. Austin, Texas. May 4, 1989.
- "Input," SIGCHI+GI'87. Toronto, Ontario, Canada. April 8, 1987.

IN THE UNITED STATES PATENT AND TRADEMARK OFFICE

| | | | |
|--|-------------------|-------------------|-----------------------------------|
| In the Reexamination of USP 7,469,381 to Ording |) | Confirmation No.: | 1195 |
| |) | Group Art Unit: | 3992 |
| Control No.: | 90/012,304 |) | Examiner: Bonshock, Dennis |
| Reexam Request Filed: | 5/23/2012 |) | Attorney Docket: |
| For: LIST SCROLLING AND |) | | |
| DOCUMENT TRANSLATION, |) | | |
| SCALING, AND ROTATION ON A |) | | |
| TOUCH-SCREEN DISPLAY |) | | |
| |) | | |

Mail Stop Ex Parte Reexam
Central Reexamination Unit
Commissioner for Patents
United States Patent & Trademark Office
P.O. Box 1450
Alexandria, VA 22313-1450

Declaration under 35 U.S.C § 132 of Prof. Brad A. Myers, Ph.D.

I, Brad A. Myers, declare as follows:

Background and Qualifications

1. I am currently a Professor in the Human-Computer Interaction Institute, which is part of the School of Computer Science at Carnegie Mellon University. My areas of concentration include user interface design, user interface software, mobile devices, computer science, visual programming, and intelligent interfaces. My full resume is attached as Exhibit 1, and more information, including my short biography, is available from my Carnegie Mellon University website (<http://www.cs.cmu.edu/~bam>).

2. I have been working in the field of user interfaces (also called Human Computer Interaction or "HCI") for over 30 years, and I am the author or editor of

over 400 publications. I have been on the editorial board of five journals, including the premier journals in the field of HCI. I have been a consultant on user interface design, implementation, and user interface intellectual property for over 70 companies.

3. I received a Bachelor of Science in Computer Science and Engineering and Master of Science in Computer Science from the Massachusetts Institute of Technology (“MIT”) in 1980. I received my Doctorate in Computer Science from the University of Toronto in 1987.

4. I worked at the Three Rivers Computer Corporation (later renamed Perq Systems Corporation) from 1980 to 1983 where I designed and implemented software, including one of the first commercial window managers.

5. Over the course of my career, I have authored multiple articles relating to, among other subjects, mobile computing, mobile phone user interfaces, web browsing on mobile devices, user interface software, window management, visualization, intelligent interfaces, and novel interaction techniques. In recognition of my contributions to research, I was selected as a Fellow of the IEEE in 2013, a Fellow of the Association for Computing Machinery (“ACM”) in 2005, and elected to the “CHI Academy” by the Special Interest Group on Computer-Human Interaction (“SIGCHI”) of the ACM in April 2004, as one of the top 25 “principal leaders of the field” of HCI. I have also received a number of “best paper” awards with my students, for example, at the USENIX 2000 Annual Technical Conference for a paper about “Integrating a Command Shell into a Web Browser”, at the International Conference on Software Engineering in 2005 and 2008, at the ACM SIGACCESS Conference on Computers and Accessibility in 2004, and at the ACM SIGCHI 2006 Conference on Human Factors in Computing Systems. As shown in my resume, this research has been funded by numerous grants from the National Science Foundation (NSF), Defense Advanced Research Projects Agency (DARPA), and many companies involved with computers and software.

6. Third parties have included me in a number of listings, including (as of 1/13/2013):

- Ranked third most published author in HCI, according to hcibib.org;
- Ranked 6th overall in all years in Microsoft's Academic Search for HCI based on "H-Index"
- Listed in The h Index for Computer Science (Computer Science researchers who have an h index of 40 or higher, according to Google Scholar); and
- Most published author at the ACM Computer Human Interaction (CHI) conference, according to Microsoft's Academic Search.

7. Between 1987-1994, I developed one of the first interface toolkits for graphical user interfaces, known as the GARNET (Generating an Amalgam of Real-time Novel Editors and Toolkits) Environment, which was influential in the field. GARNET allowed software developers to create interactive, graphical user interface software in different operating systems such as UNIX. GARNET could receive stylus or mouse inputs. One feature of GARNET was that inputs could be processed through a gesture recognition system that included a recognition library supporting two-dimensional shape gestures corresponding to delete, select and other commands.

8. I have had a research project focused on the user interfaces for mobile handheld devices that have touchscreens since the fall of 1997. My research group has used a wide variety of Personal Digital Assistants (PDAs) and mobile phones to develop a number of application programs. One aspect of this research, which we call the "Pebbles" project, has been to invent a number of novel interaction techniques for interacting with such devices using touch screens, including how text can be more easily entered into small devices. I was invited to give two keynote talks at conferences (MUM2004 and Mobile HCI'02) on the Pebbles research, and the 2004 and 2006 best paper awards mentioned above were also a result of this HCI research.

9. I was an early user of the world-wide web (“WWW” or “web”), and web pages that I authored won awards as early as 1996. Currently, there are over 2,000 pages on the web that my group and I have authored, for projects, courses, and personal information. (See, e.g., <http://www.cs.cmu.edu/~bam>).

10. I regularly teach courses on user interface design and software. In particular, I have taught about user interfaces for consumer electronics such as mobile devices since at least 1989, and continue to teach such courses today.

Information And Opinions Concerning Rejections

11. This declaration is intended to provide information and opinions concerning the rejections of claims 1 to 20 in the reexamination of the issued ‘**381** patent, i.e., U.S. Patent No. 7,469,381.

12. As requested, in preparation for this declaration, I have studied:

- (a) the issued ‘**381** patent including the specification, figures and claims:
- (b) the Office Action issued 10/15/2012 in the reexamination of the issued ‘**381** patent:
- (c) the claim mappings incorporated in the Office Action by the examiner from the third party Request for Reexamination of the issued ‘**381** patent:
- (d) The **Lira** patent application, Lira WO 03/081458, cited as a reference in the Office Action: and
- (e) The **Ording ‘975** patent, (U.S. Patent No. 7,786,975, Ording,) also cited as a reference in the Office Action.

13. My opinions are presented below, as follows:

- I. The issued ‘**381** patent
- II. The disclosure of **Lira**
- III. A comparison of **Lira** and the issued ‘**381** patent.

IV. The disclosure of **Ording '975**.

V. A comparison of **Ording '975** and the issued **'381** patent.

I. The issued **'381** patent

A. Introduction

14. The **'381** patent provides an elegant, visual and intuitive solution to an old user interface issue: what to do when a user scrolls to the edge of an electronic document? This problem can happen if, for example, a user is zoomed in on one part of a large electronic document, such as a webpage, and scrolls the document while trying to look at other parts of it. Not knowing exactly where the document ends, he may continue to scroll in a direction even when there is no more of the document to display.

15. In the prior art, when a user scrolled to the edge of a document, one of two scenarios would play out. Either he would scroll continuously past the edge of the document into nothingness (*i.e.* beyond a place where there was any meaningful content), or he would hit a “hard stop” and not be allowed to scroll any further.

16. Each of these scenarios has its own disadvantages. Allowing a user to move through virtual space beyond a place that has any meaningful content can cause the user to become disoriented. This problem has also been referred to as the “Desert Fog” phenomenon. (See *ex.*, Benjamin B. Bederson, *The Promise of Zoomable User Interfaces*, Behavior and Information Technology, April 21, 2011). Users who navigate into these empty spaces may get lost or disoriented and not know how to find their way back.

17. Most user interfaces avoided the “Desert Fog” problem by enforcing a hard stop at the edge of a document. But that solution has its own disadvantages. If the user does not realize he has hit the edge of a document, he may keep trying to move the document in vain. No matter how hard he tries, however, the device will not allow the document to move. As a result, the user may think his device has frozen or locked up, or that it is otherwise not registering his input. In any case,

the user could become frustrated when the scrolling or translating does not reflect his intent ('381 Patent at 2:26-28).

18. The inventor of the '381 patent recognized these disadvantages and created a novel solution to overcome them. By displaying an area beyond the edge of an electronic document which automatically shrinks and disappears when the user stops trying to scroll, the invention of the '381 patent provides the user with an instant visual cue informing him that the edge of the document has been reached, and importantly, in an exemplary embodiment shown in **Figs. 8A-8D** of the patent, this area beyond the edge is displayed adjacent to a portion of the electronic document, enabling the user to maintain context and avoid the "Desert Fog" problem.

19. I believe that there has been undisputed praise or industry acclamation for Apple's user interface technology as implemented on its iPhone, iPod touch, and iPad products.¹ I also believe that the inventions of the '381 patent contributed to the intuitive, elegant user interface that was credited with helping make the iPhone a success.

¹ Steve Jobs, iPhone Introduction, <http://www.youtube.com/watch?v=6uW-E496FXg>, at 16:16 – 16:33 (audience reaction and statement "isn't that cool, do a little rubber-banding up when I went off the edge?")

Lev Grossman, "Invention of the Year: The iPhone," Time, Nov. 1, 2007, http://www.time.com/time/specials/2007/article/0,28804,1677329_1678542_1677891,00.html (APLND0001244544-45);

Engadget, "Ten Gadgets that Defined the Decade," Dec. 30, 2009, <http://www.engadget.com/2009/12/30/ten-gadgets-that-defined-the-decade/> (APLND000142002-12);

Tom Krazit, "Apple's iPhone Wins Second J.D. Power Award," April 30, 2009, http://news.cnet.com/8301-13579_3-10231135-37.html (APLND000238314-17).

David Pogue, "The iPhone Matches Most of Its Hype," NY Times, June 27, 2007, <http://www.nytimes.com/2007/06/27/technology/circuits/27pogue.html?pagewanted=1&r=1&ef=iphone> (APLND000147846-49);

Korea JoongAng Daily, "Apple's iPhone Tops List of Innovative Inventions," Feb. 18, 2008, <http://joongangdaily.joins.com/article/view.asp?aid=2886322> (APLND000233346-45); and

Walter Mossberg & Katherine Boehret, "Testing Out the iPhone, The Wall Street Journal, June 27, 2007, <http://online.wsj.com/articles/SB118289311361649057.html> (APLND000147593-597).

B. The Problem

20. The specification of the ‘381 patent is related in part to devices with touch screen displays and to translating electronic documents on such touch screen displays. In the patent, an electronic document, such as a webpage, is defined by and may be displayed from an electronic file.

21. The phrase “electronic file”, as used in the ‘381 specification, is used in reference to a digital file which contains display data for the display of an “electronic document having a document length and a document width, to be displayed on a touch screen display”, see for example col. 2, lines 14-19:

As a result of the small size of display screens on portable electronic devices and the potentially large size of electronic files, frequently only a portion of a list or of an electronic document of interest to a user can be displayed on the screen at a given time. Users thus will frequently need to scroll displayed lists or to translate displayed electronic documents.

and col. 6, lines 18-21 (emphasis added):

In accordance with some embodiments, a graphical user interface on a device with a touch screen display includes an electronic document having a document length and a document width, to be displayed on the touch screen display

22. A person of ordinary skill in the art reading the ‘381 specification at the time the invention was made would not expect these “electronic documents,” as described in the patent, to further include display data for the display of areas beyond the document length or width; that is, would not expect such electronic files which contain data for the display of “an electronic document having a document length and a document width, to be displayed on the touch screen display,” to further contain data for the display of areas beyond the edges of the electronic document of a particular height and width to be displayed.

23. In the issued ‘381 patent, one problem to be solved is related to translating large electronic documents displayed on the small touch-screen displays of portable electronic devices in order to view all portions of the electronic document,

see col. 2, lines 14-19, reproduced above. If the electronic document (at a reasonable display magnification, if magnification can be adjusted) is too large to be fully displayed on the smaller touch-screen display, the user must translate the document to view different portions of it in the display.

24. Although the electronic file may be a local file which is stored and modifiable in the display device, the electronic file is often stored elsewhere and merely displayed on the touch-screen device. For example, touch-screen devices are typically used to display web pages, which are not locally available or modifiable and may be streamed. The GUI should ideally operate in each of these possible circumstances.

25. When the user must translate a document to view different portions of it in the display, a user may become frustrated if the translation does not reflect the user's intent, see col. 2, lines 26-28.

26. In my opinion, the problem described in the '**381** patent specification includes the well-known problem that when a user of prior art devices translated a larger electronic document on a smaller touch-screen display device, the portion of the document in the display would occasionally stop moving. In particular, for example, where translation occurs in response to detecting the user moving an object (such as a finger) on or near the display, when an electronic document was translated by the user to a point of reaching a previously off-screen edge of the document, the display would effectively be pinned against that edge and appear to freeze because the device would cease to translate the document when the edge of the document was reached. This could frustrate the user, who might not realize why the translation stopped and might think that the device was not operating properly, see, for example, col. 2, lines 28-30.

27. Aspects of this problem can be understood from Illustrations **II**, **III** and **IV** presented below. Illustrations **II** and **III** are based on **Figs. 8A** and **8B** of the '**381** patent, in which an outline of webpage electronic document **3912** to be displayed is depicted and is shown to be translated so that a different portion of the electronic

document area is displayed through the display window of touch screen display 112 during and after translation.

28. In order to show that Illustrations II to IV accurately illustrate the entire electronic document to be displayed, **Fig. 10C** of the '381 patent is first presented below as Illustration I.

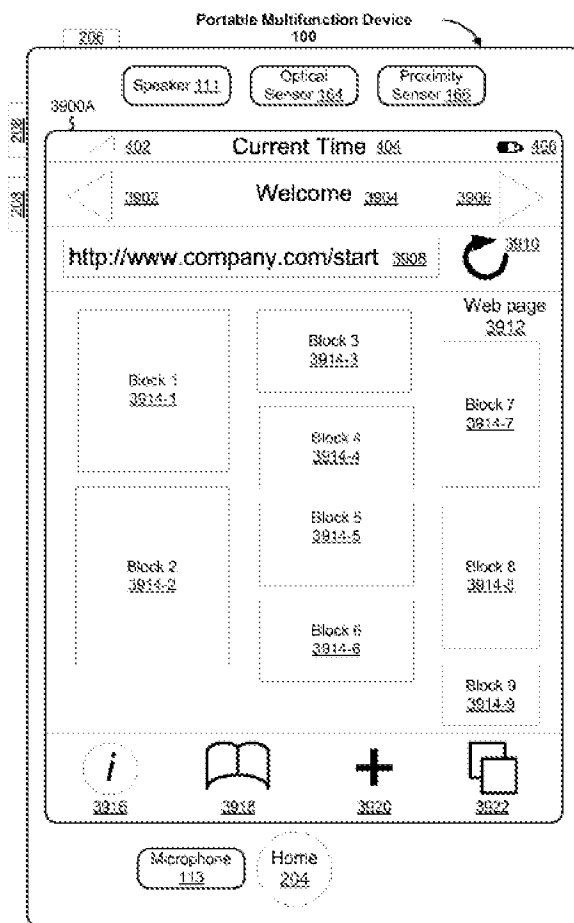

Figure 10C

ILLUSTRATION I: Fig. 10C of '381 patent

29. Illustrations II to IV below are sketches based on portions of **Figs. 8A to 8C** of the '381 patent, illustrating the problem to be solved.

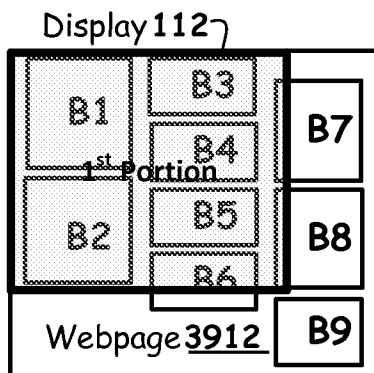

ILLUSTRATION II: Sketch based on Fig. 8A of '381 patent

30. In Illustration II, above, a portion of an electronic document, such as webpage **3912**, is being displayed on a portion of touch screen display device **112**. The displayable area of webpage **3912** is larger than the portion of display **112** used for displaying the electronic document, so only a portion of the webpage can be displayed on the screen at a given time, and only a 1st portion is visible in display **112** in the sketch above. In this sketch, for clarity, the remainder of the defined area of the electronic document is illustrated in an area outside of the display window.

31. In this 1st displayed portion of webpage **3912**, blocks B1 to B5 (generally in the upper left hand side of the webpage as shown) are displayed generally in their entireties within display screen **112**, while only portions of blocks B6 to B9 (generally in the lower right hand side) are displayed in display **112**.

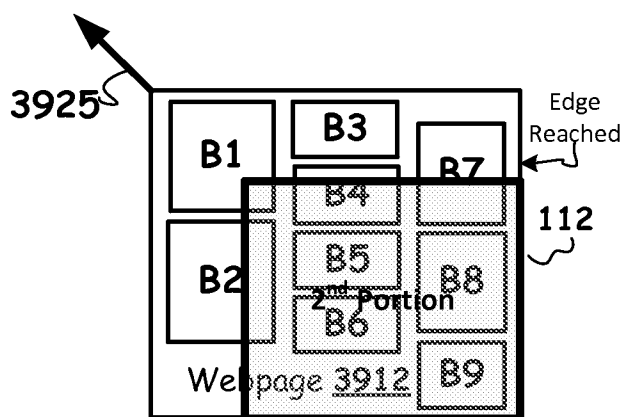

ILLUSTRATION III: Sketch based on Fig. 8B of '381 patent

32. Illustration III illustrates the translation of webpage 3912 toward the upper left as a result of the user's gesture 3925, on or near touch screen display 112, toward the upper left. In this case, gesture 3925 has caused webpage 3912 to translate in direction 3925, and reach an edge of the displayable area of webpage 3925 in display 112. A 2nd portion of webpage 3912 is now displayed, showing, for example, substantially all of blocks B4-B6 and B8-B9 and portions of blocks B1, B2 and B7.

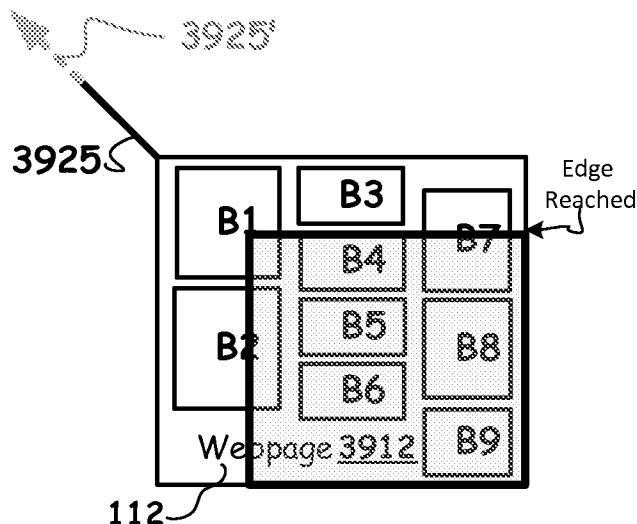

ILLUSTRATION IV: Sketch (based on Fig. 8B of '381 patent) illustrating problem

33. Illustration **IV**, above, illustrates the problem with the prior art methods when the user's movement may indicate the user's intent to translate (or continue to translate) past the reached edge of the displayable area defined in the electronic document. If the translation ceases when an edge of the displayable area of the document is reached, the user may not even know whether an edge has been reached, and the cessation of translation may make the user think that there has been a device failure, or that the user's pen or finger is no longer being fully detected.

34. For example, gesture **3925'** shown in Illustration **IV** may be a continuation of gesture **3925** which attempts to translate webpage **3912** past the edge of the electronic document reached and display an area not defined within the electronic file. The attempt fails in the prior art method, typically by not translating the portion of the webpage being displayed beyond the area defined in the electronic document.

C. The Solution

35. The '**381** specification teaches a method in which, stated very briefly, an electronic document is translated in response to detected movement of an object such as a finger, and, in response to reaching an edge of the displayable area of the electronic document during translation in a 1st direction, actions are taken which allow translation to continue and allow that edge of the electronic document to be translated onto the display and an area beyond the edge to be displayed; after which, in response to detecting that the user has lifted his finger off the screen, action is taken to translate the electronic document in a second direction until the area beyond the edge is no longer displayed.

36. In particular, the size of the portion of the electronic document displayed is reduced and an area not within the displayable area of the electronic document is displayed beyond that edge. As a result, translation onto the display can continue beyond the edge of the displayable area of the electronic document as long as the

detected movement indicates the user's intent to continue to translate in this 1st direction.

37. It is important to note that the phrase "display an area beyond the edge of the document", as appears for example in step **714** of **Fig. 7** of the '**381** patent (see Illustration **V** below), refers to a property of the area to be displayed, not just the location where it is to be displayed. The area to be displayed is beyond the area that, according to the '**381** patent, is defined within the electronic file as the displayable area, having "a document height and a document width," of the webpage electronic document **3925**, see col. 6, lines 18-21. The phrase "display an area beyond the edge of the electronic document" means to display an area which is not displayed simply as a result of webpage **3925** being displayed according to its associated electronic file, but is displayed because of some other, further mechanism.

38. Thereafter, when movement is no longer detected, such as because the user has lifted the finger or other object off of the display, the document is automatically translated in a 2nd direction until the area outside the displayable area of the electronic document is no longer displayed. This then allows the user to view the maximum amount of the document adjacent to the edge of the document simply by lifting the user's finger, without needing additional user inputs to reposition the document.

39. Returning now to the '**381** specification, the solution discussed above is further illustrated in Illustrations **V**, **VI** and **IX** below, which are based on **Figs. 7**, **8C** and **8D** of the '**381** patent respectively, see for example col. 2, line 67 to col. 3, line 3; col. 26, line 63 to col. 27, line 55; col. 28, lines 27-39 and others. Illustration **VII**, comparing sketches based on **FIGS. 8A** and **8D** of the '**381** patent, is also used in this discussion.

40. In Illustration **V**, below, process flow **700** of the solution shown in **Fig. 7** of the '**381** patent is presented and described in more detail below.

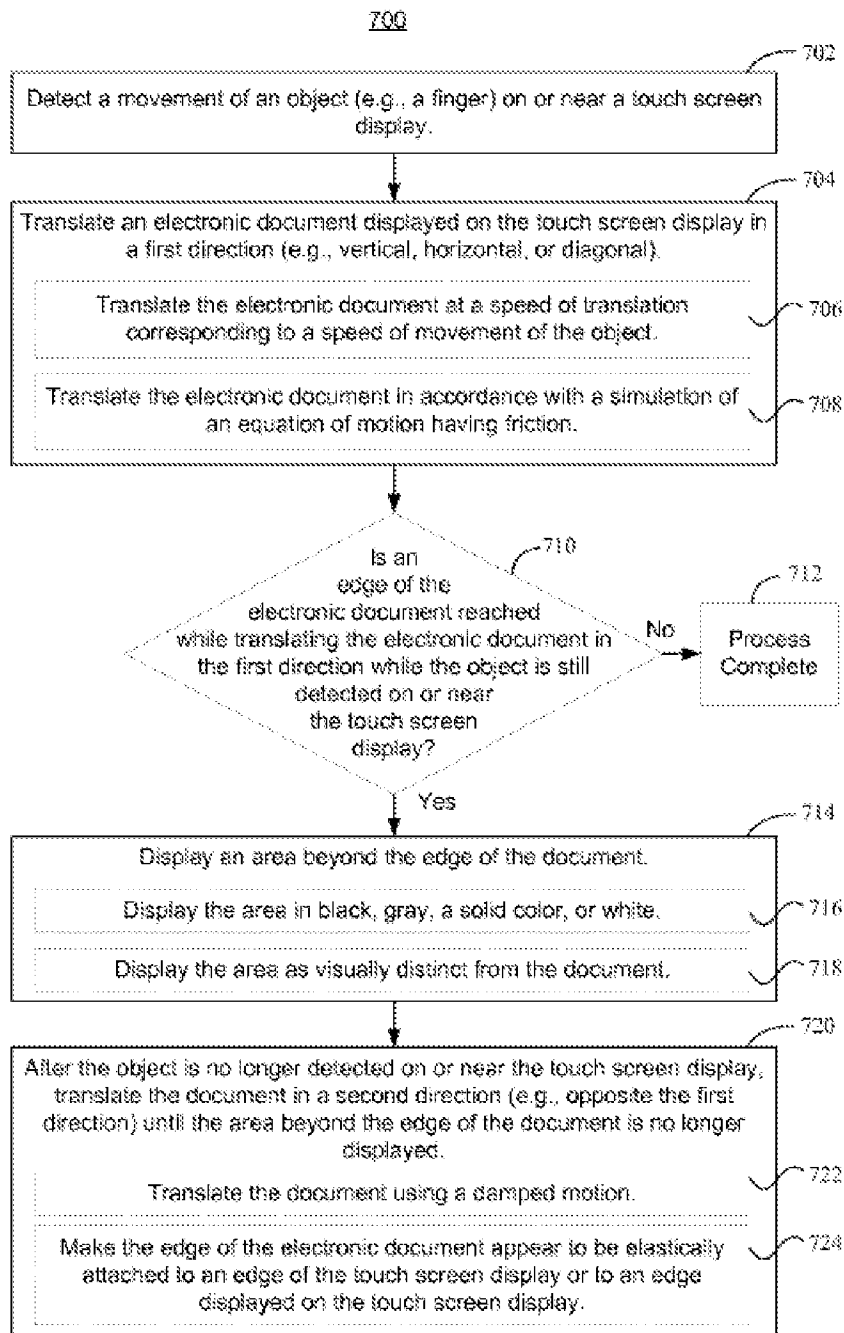

Figure 7

ILLUSTRATION V: Fig. 7 of '381 Patent, showing process 700

41. A 1st portion of webpage 3912 is shown in Illustration II above, within the display window of touch-screen display device 112.

42. Process **700** for translating an electronic document begins with step **702**, in which movement, for example, of the user's finger on or near touch screen **112**, is detected. This detected movement may be the result, for example, of the user's gesture such as gesture **3925** shown in Illustration **III** above. In step **704**, webpage electronic document **3912** is translated in a 1st direction consistent with that gesture, along a distance related to the movement detected in step **702**, to display a 2nd portion of webpage **3912**, as shown in Illustration **III**. That is, webpage **3912** is translated relative to touch-screen display **112** toward the upper left as shown, so that a 2nd portion of webpage **3912** is displayed.

43. Process flow **700** then moves to determination step **710**, in which a determination is made of whether or not an edge of webpage electronic document **3912** is reached in display **112**:

- (a) while translating in the 1st direction and
- (b) while the finger is still detected on or near the touch screen display.

44. If the determination result is negative, that is, if an edge of the displayable area has not been reached under the specified conditions, the process flow moves along the "No" path to step **712**, "Process Complete." Thereafter, the process flow may be reinitiated upon detection of further movement, see '**381** patent at col. 28, lines 27-33:

If an edge of the electronic document is not reached while translating the electronic document in the first direction while the object is still detected on or near the touch screen display, 30 the process **700** is complete (**710-No, 712**). The process **700** may be re-initiated upon subsequent detection of another movement of an object on or near the touch screen display (**702**).

45. If, while translating in the 1st direction and while the finger is still detected on or near the touch screen display, determination step **710** detects an edge of webpage **3912** being reached in display **112**, as shown in Illustration **III**, *i.e.*,

making the determination result positive, the process flow moves along the “Yes” path to display an area beyond the electronic document defined in the electronic file, in accordance with step 714 as shown in Illustration VI, below.

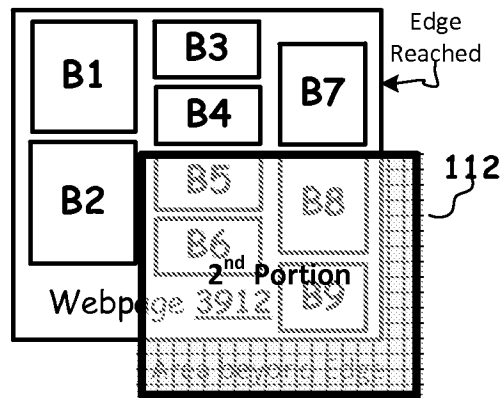

ILLUSTRATION VI: Sketch based on Fig. 8C of ‘381 Patent

46. Illustration VII below, comparing sketches based on Figures 8A and 8B of the ‘381 Patent (*compare* Illustrations II and III above), illustrates that the determination step 710 in Illustration V makes a positive determination that an edge has been reached if and only if an edge of webpage 3912 is reached in display 112, and not when a so-called “internal edge” of an internal element of webpage 3912, such as an edge of an internal block, for example B1-B9, is reached,.

47. First, in sketch VIIA below, based on Figure 8A of the ‘381 Patent, display 112 displays the upper left corner of the larger webpage 3912 and the bottom and right side edges of webpage 3912 are outside display 112. Next, in sketch VIIB, based on Figure 8B, webpage 3912 is translated in response to gesture 3925 toward the upper left so that the lower right of webpage 3912 is displayed. That is, the right and bottom edges of webpage 112, previously outside display 112, have now been reached in display 112.

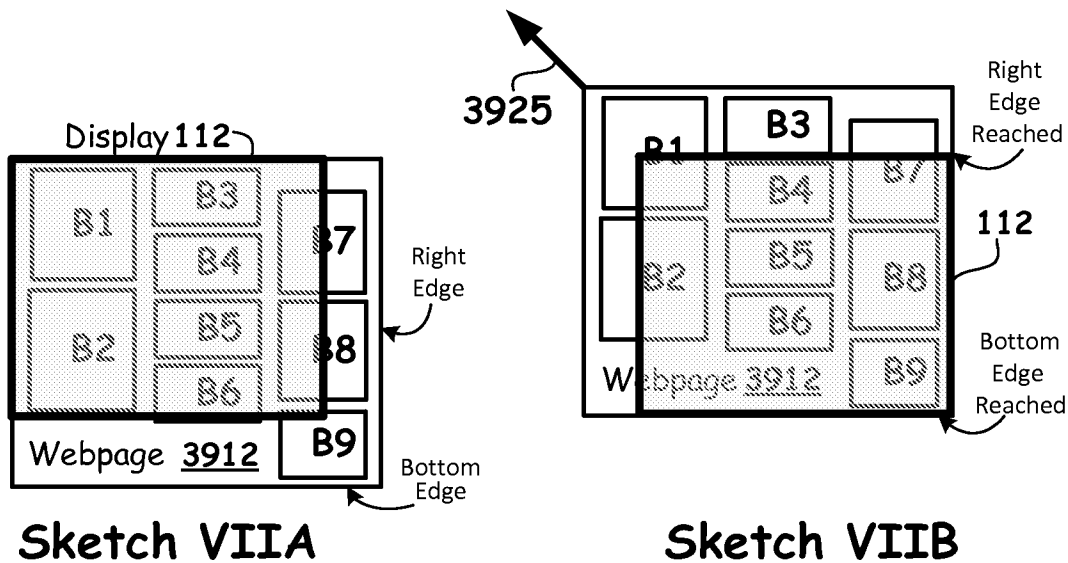

ILLUSTRATION VII: Comparison of sketches based on **Figs. 8A & 8B** of '381 Patent

48. In accordance with process **700**, shown in Illustration **V** above, when determination step **710** processes the translation of the electronic document from the position in sketch **VIIA** to a position short of the position shown in sketch **VIIB**, the process **700** proceeds to follow the “**No**” path indicating that the edge has not been reached in display **112**. However, when the electronic document is translated to the position in sketch **VIIB**, detection step **710** determines that the right and bottom edges of webpage electronic document **3912** have been reached in display **112**. As noted above, process **700** then follows the “**Yes**” path and begins to display an area that is not within the area defined for display in webpage electronic document **3912** as shown in Illustration **VI**, above. For clarity, in sketches **VIIA** and **VIIB**, the right and bottom edges of webpage **3912** are annotated to show when the right and bottom edges are reached.

49. The areas beyond the right and bottom edges of **B9** are displayed in response to the edge of **B9** being reached (a) while translating webpage **3912** in direction **3925** and (b) while the finger is still detected on or near the touch screen display.

50. It should be particularly noted that, in the examples of the process **700** just discussed, when the right and bottom boundaries of internal Block **B9** are reached nothing happens in response thereto. Insofar as process **700** is concerned, the device does not take any particular notice, start or stop any process, set or reset any particular variable, or in fact do anything in particular, when these boundaries are reached, since the area just outside of **B9** (*i.e.*, past the right and bottom boundaries of **B9** but still inside web page **3912**) is simply an area like any other area that is displayed as a part of carrying out step 704. Thus, the '**381** specification makes clear that process **700** ignores the so-called "internal edges" of the electronic document. Furthermore, process **700** would still ignore these so-called "internal edges" even if the blocks were displayable objects such as digital images, for the '**381** Patent specifically mentions that such blocks may be images, see '**381** at col. 28, lines 62-64:

Web page **3912** or other structured document, which is made of blocks **3914** of text content and other graphics (e.g., images);

51. Analysis of **Figs. 8A** and **8B** of the '**381** Patent, shown below in Illustration **VIII** below, confirms that although the right and bottom boundaries of Block **9**, for example, are initially beyond display **112** in Figure **8A**, and the translation reaches the right and bottom boundaries of Block **9** at some point before it reaches the bottom and right edges of webpage **3912** in Fig. **8B**, no area beyond the edge of webpage electronic document **3912** is displayed in response to the so-called "internal edge" of Block **9** being reached in Fig. **8B**. Instead, the area just outside Block **9** has already been displayed by the translation provided in step **704**.

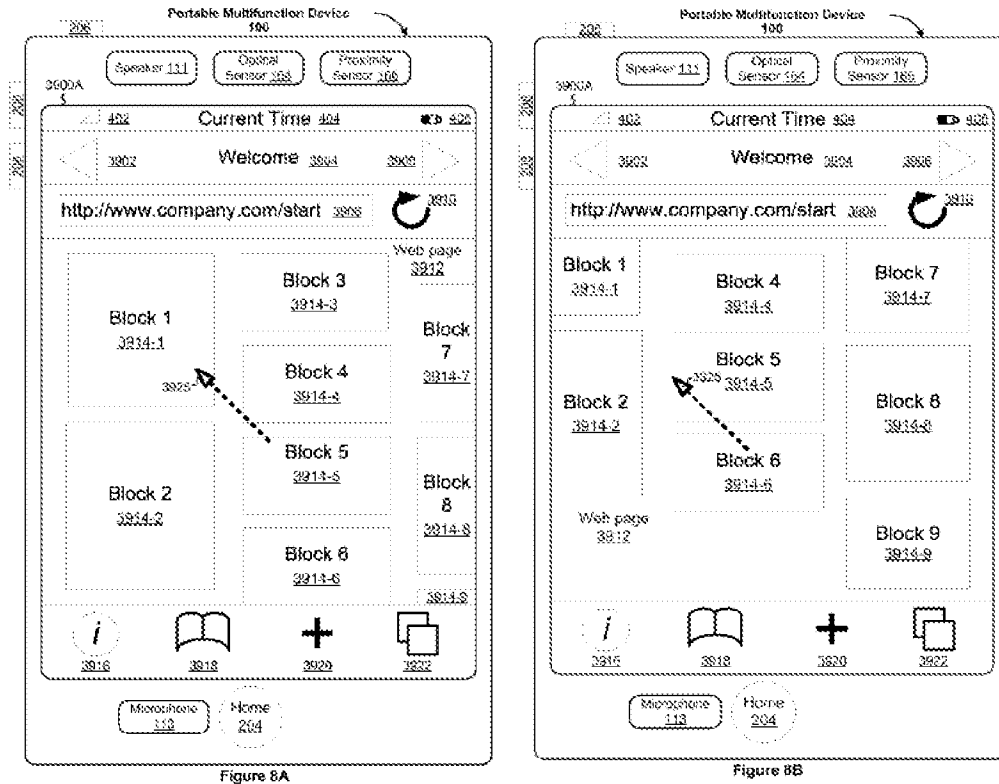

ILLUSTRATION VIII: Figs. 8A and 8B of '381 Patent

52. Returning now to process 700 shown in Illustration V earlier, above, the process flow after step 714 continues to step 720. If liftoff is detected, webpage 3912 is translated in a 2nd direction until that area beyond the edge is no longer displayed as shown in Illustration IX, below, displaying a 4th portion of the webpage.

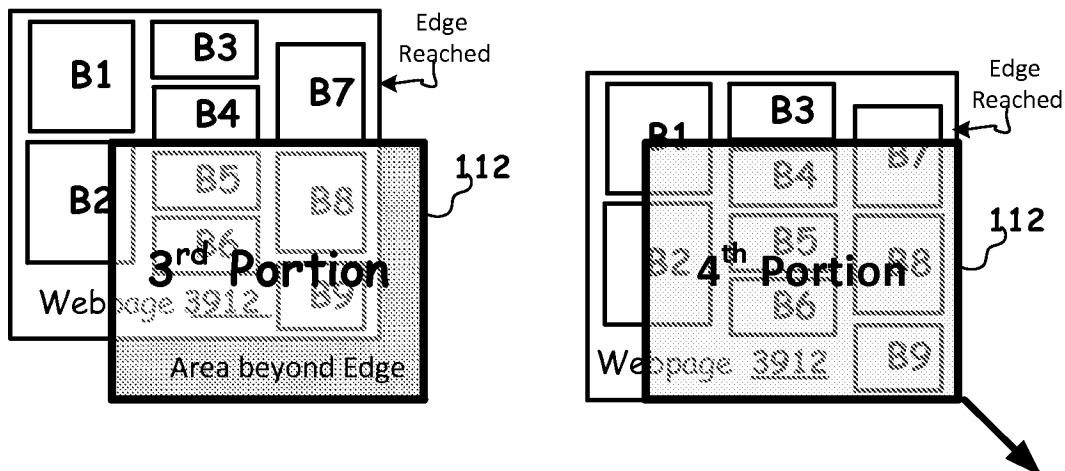

ILLUSTRATION IX: Sketches based on Figs. 8C and 8D of '381 patent

II. The disclosure of Lira

53. **Lira** discloses an approach to navigating within the displayable edges of a webpage, or other electronic document, on a smaller touch-screen display device, by formatting the contents of the electronic document into at least two logical columns, each no wider than the display. In one embodiment directed to scrolling up or down such logical columns, **Lira** discloses alignment controls that operate to re-center the column in the display after the user lifts the stylus or other object with which the user was controlling the scrolling, if the user had inadvertently not scrolled exactly upward or downward, see **Lira** page 1, line 28 to page 2, line 12.

54. In particular, **Lira** discloses that “[w]eb pages and other electronic documents generally are formatted for viewing and navigation in display windows of standard-sized or oversized displays,” see **Lira** page 1, lines 6-8, and may therefore be difficult to read on small display windows, see **Lira** page 1, lines 10-14.

55. The solution to this problem proposed by **Lira** was to divide the width of the electronic document into columns based on the content of the electronic document, for example using existing columns on an HTML encoded page, even if the

columns displayed do not have a uniform width, see **Summary** page 1, lines 16-20 (emphasis added):

“A document served to a device having a small display or a small display window, such as, for example, a PDA, a telephone, a handheld computer, or an electronic book, can be reformatted such that the width of the document is divided into columns, with each column being displayable across the entirety of the small display or display window.”

56. In particular, **Fig. 4A** represents webpage **400** for display on a large display (wide window width **410**) which is then reformatted as web page **415** for display on a narrow display (PDA display width 425), see page 9, line 29 to page 30 line 2:

“Figs. 4A and 4B show that a page 400 (Fig. 4A) having elements 402, 404, 406 and 408 of differing widths and sized to fit a wide window width 410 may be reformatted as a page 415 (Fig. 4B) having elements 417, 419, 421 and 423 with widths corresponding to the width 425 of a narrow display (e.g., a PDA display).”

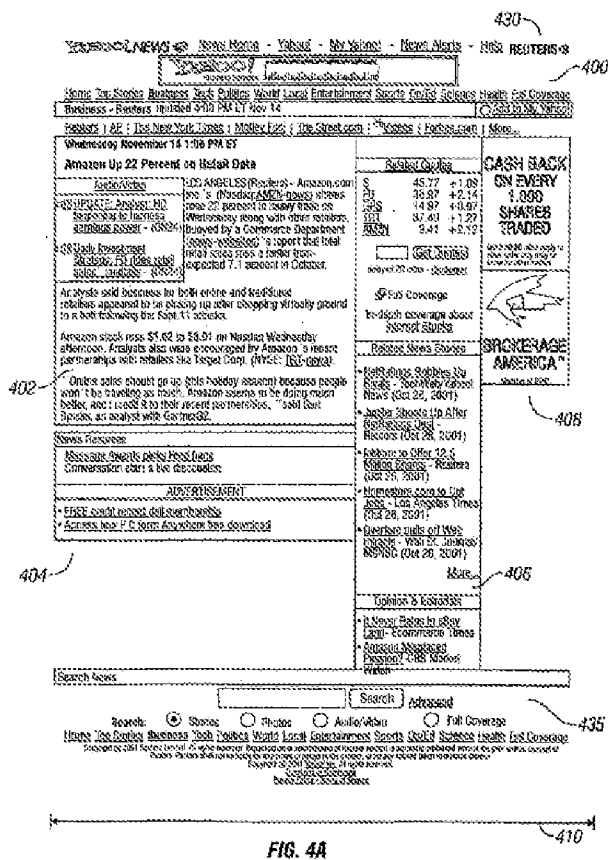

FIG. 4A

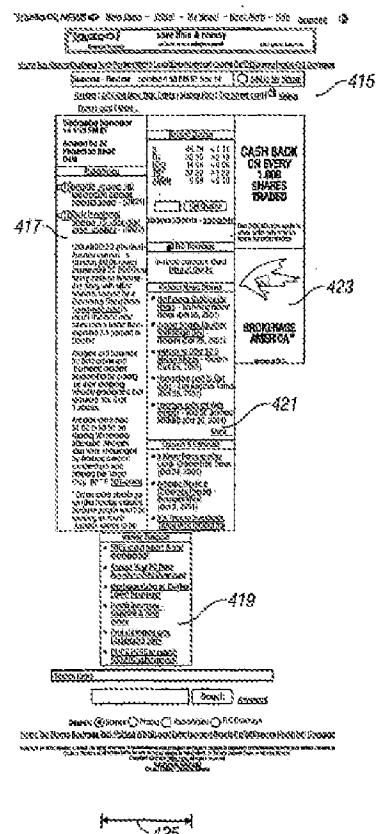

FIG. 4B

ILLUSTRATION X: Sketches based on Figs. 4A and 4B of Lira

57. A comparison of original page 400 (Fig. 4A) and page of information 415 (Fig. 4B) resulting from the reformatting of page 400 shows that the webpage is a document and during formatting, the entire width of page 400 is reformatted into columns abutting each other, so that a single document, page 415, remains after reformatting. A person of ordinary skill in the art at the time of the invention would understand that any areas surrounding the reformatted columns shown in Fig. 4B would remain part of web page 400. Those areas could be defined, for example, as the background color in the HTML of the web page, and would therefore remain part of the web page after reformatting.

58. The abutted-together columns are also shown in Figs. 8A-C, 13 and 14A-B. In certain of Lira's figures the columns of text and images are drawn somewhat separated from each other. However, no such separation is ever disclosed or

discussed in the text, and when the figures include close-up (sometimes called “exploded”) views, the close-up views do not show this separation. See, for example, the enlarged sections of **Figs. 13, 14A-B** in illustration XI:

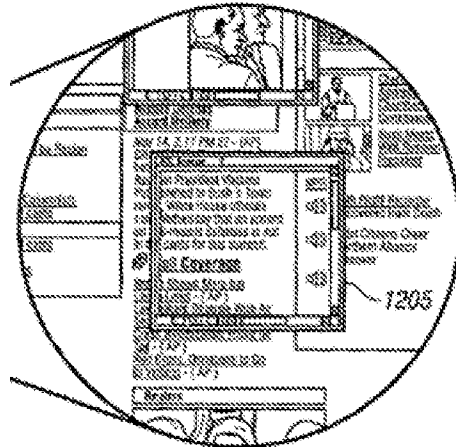

Fig. 13
Exploded
View

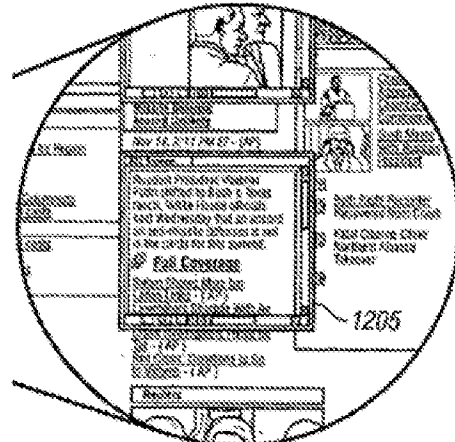

Fig. 14A
Exploded
View

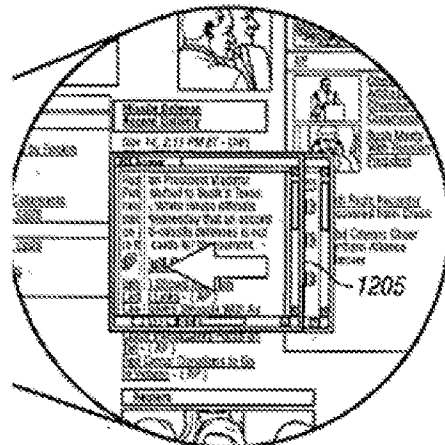

Fig. 14B
Exploded
View

ILLUSTRATION XI: Exploded views from **Figs. 13, 14A** and **14B** of Lira

59. These disclosures and figures contain no indication that, when the electronic document is reformatted into a page having logical columns, the result would be more than one document.

60. It is important to note that **Lira** teaches that the logical, reformatted columns of the electronic document, such as web page **1210**, are part of the content of that electronic document. That is, columns **1215**, **1220** and **1225** are not disclosed in **Lira** to be sub-documents somehow embedded into webpage **1210** – indeed, the possibility of “embedded” documents or “sub”-documents is not discussed or even hinted at – but rather the columns are merely reformatted portions of the content of that document – web page **1210** – and each column has a width that does not exceed the width of the display window, see **Lira**, page 1, lines 16 to page 2, line 3. **Lira** distinguishes the web page “electronic document” from the reformatted “logical columns” of the web page’s content, stating that “detecting the layout of the electronic document may include detecting logical columns of the electronic document, and that reformatting the electronic document may include reformatting each logical column to have a width that does not exceed the width of the display window,” **Lira** at page 2, lines 5 to 8 (emphases added).

61. In **Lira**, reformatting a web page into three columns does not generate any separate or embedded “electronic documents,” any more than reformatting a business letter in a word processing program to have three columns creates any separate or embedded electronic documents. If **Lira** had intended such an unusual meaning, one would have expected **Lira** to have at least once referred to the columns, or anything else, of the web page as being “documents” themselves – and to have described the creation of the logical columns in terms of removing or at least changing the contents of the original web page, instead of simply “reformatting the electronic document,” see **Lira** at page 2, lines 5 to 8 (emphasis added). In particular, a person of ordinary skill in the art at the time of the invention would have understood **Lira’s** disclosure to mean that the reformatted columns

remain part of the single electronic document and do not become “embedded” documents or “sub”-documents”.

62. **Lira** specifically uses the term “electronic document” at least 54 times, and each and every time, it refers to the entire “page of information.” **Lira** uses “page of information” at least 94 times, and each and every time, it refers to the entire web page or other electronic document. For example, “Web pages and other electronic documents” (**Lira** at page 1, line 6), “The page of information may include a Web page coded in HTML” (**Lira** at page 6, line 29), etc. A person of ordinary skill in the art at the time the invention was made would understand that when such an “electronic document” is merely “reformatted,” the result is still a single electronic document. This is entirely consistent with the teaching in **Lira** – for example, the flowchart of **Fig. 5**, step **515** is: “Reformatting the Web Page into Aligned Columns Viewable on the Display Window”, which a person of ordinary skill in the art at the time the invention was made would understand to mean that the result remains a single web page which now contains the reformatted columns as “Aligned Columns.”

63. With respect to any separation **Lira** arguably shows within the content on the web page (or other electronic document), **Lira** is completely silent about such separation, if any. One of ordinary skill in the art at the time the invention was made would clearly understand such separation, if any, to be part of the electronic document, for example, the background of the web page. In particular, for web pages, one of ordinary skill in the art at the time the invention was made would understand that the background of web pages can be defined by the HTML, such as a color specified as part of the HTML <body> tag. Therefore such separation(s), if any, remain part of the electronic document, and controlled by the contents of the electronic document, and these areas are not beyond the edge of the electronic document in any sense.

64. **Lira** teaches that “Once the HTML tags are identified, the page may be recoded in a language other than HTML for easier viewing on the small display

window,” see **Lira** at page 11, lines 8-9. One of ordinary skill in the art at the time the invention was made would understand this to mean that the resulting page could be encoded in HTML, or else it could use an encoding used for the small devices of the time, such as WML for WAP devices. Such a change, however, would not in any way suggest that the “recoded” page would become more than another *single* “electronic document”.

65. Further, a specific objective disclosed in **Lira** is to keep the display centered on the logical column of content that is being viewed, see **Lira** page 2, lines 11-12; page 11, line 27 to page 12, line 2; and page 14, line 18 to page 15, line 7.

66. **Lira** describes a prior-art approach in which “the page 100 [is] reformatted as a single column,” so no horizontal scrolling is used in a single column display, and the display “stays centered on the column as the user scrolls down the page to read the text,” see **Lira** page 9, lines 21-28:

PDA browsers may use various reformatting methods to enhance the readability of the page. Reformatting may include scaling down images, text size, and other page components.

Fig. 3 shows the page 100 reformatted as a single column 300. In particular,
25 the columns of the page 100 are stacked to form the single column 300, the width of the column 300 is limited to the width of the display window 200, and word wrapping is used to provide continuity/readability. The display window 200 stays centered on the column as the user scrolls down the page to read the text.

67. **Lira** discloses a different solution, where “[v]iewing an electronic document in a display window” may include a series of steps, including that “[t]he electronic document may be reformatted into at least two columns, with each of the columns having a width that does not exceed a width of the display window,” see **Lira, Abstract**. Thereafter, “the position of the visible portion of a page of information” (i.e., the reformatted webpage) may be changed in response to navigation, and/or constrained, see **Abstract** (emphases added):

Navigating on the display may include tracking motion of an input tool on a display, comparing a motion of the input tool to a threshold, and changing a position of the visible portion of a page of information on the display if the input tool motion exceeds the threshold. The position of the visible portion of the page of information on the display may be constrained if the motion does not exceed the threshold.

68. In one implementation in **Lira**, horizontal wobble when a column is being scrolled vertically in the display can be minimized by use of a “vertical alignment control”, to ignore slight horizontal motion as the user scrolls up or down the column. In other words, the alignment control may be used to constrain screen scrolling to two directions only: up or down, see page 14, line 29 to page 14, line 7; and **Fig 14A**, a portion of which is shown below as Illustration **XII**.

69. The black arrows alternating from left to right represent the user's movements intended to scroll down the logical column but inadvertently moving slightly from side to side in doing so, see **Lira** page 14, lines 20-28. The horizontal portions of the user's movements are ignored in this embodiment to keep the display aligned to the column being viewed. See **Lira** page 14, line 29 to page 15, line 7. It should be noted that this vertical alignment control in the embodiment of **Fig. 14A**, although it can be enabled or disabled by the user, operates while the user's pen or finger remains on the screen.

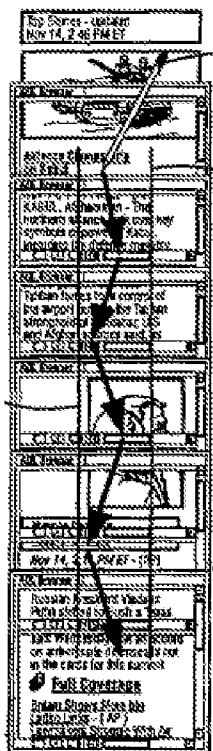

ILLUSTRATION XII: Portion of Fig. 14A of Lira

70. In contrast, in the embodiment of Fig. 14B, the alignment control is only enabled when the user lifts pen 1200 from display 1205, which allows the display to “wobble” back and forth before liftoff, see Lira page 15, line 18-21 & Fig. 14B. At finger liftoff, the enabled alignment control has several possible functions, one of which causes logical column 1220 to “snap” back into alignment with display window 1205 as the user stops scrolling, see Lira, page 15, lines 18-25, which is shown immediately below with redactions for clarity:

Referring to Fig. 14B, in another implementation, the vertical alignment control is enabled when the user lifts the pen 1200 from the display 1205. This causes
 20 the logical column 1220 to snap into alignment with the display window 1205 as the user stops scrolling.

If the user’s scrolling does not exceed the threshold, which indicates an intention to continue to view the text column 1220, the display 1205 centers the
 25 logical column 1210 as the pen 1200 is lifted from the screen.

This “snapping” behavior is depicted in **Lira Fig. 14B**, reproduced below as **Illustration XIII**;

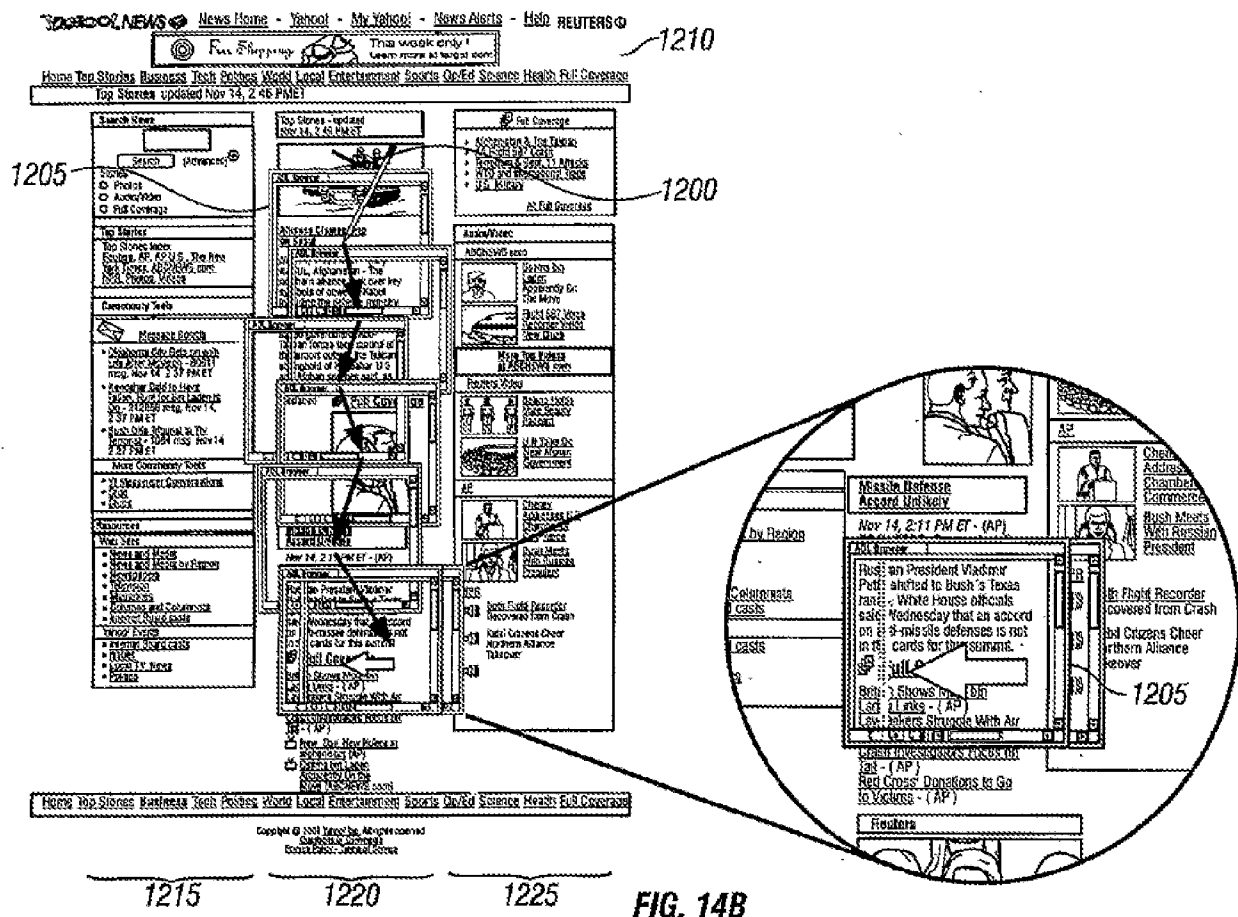

ILLUSTRATION XIII: FIG. 14B of Lira

71. As shown on the left side of **Figure 14B** of **Lira**, the upper black arrows illustrate the user’s movements while scrolling downward. The positions of display screen **1205** vis-à-vis web page **1210** and column **1220** clearly illustrate that the alignment control does not constrain horizontal movements (wobble) of display **1205** in response to the horizontal portions of the user’s movements while scrolling generally down the column, see **Lira** at page 15, lines 18 to 31. It should be noted that such wobble would not have happened if the embodiment of **Fig. 14A** of **Lira** (see **Lira** at page 14, line 29 to page 15, line 17) was active (which prevents such

horizontal “wobble” movements). The implementations of the vertical alignment control in **Figs. 14A** and **14B** are mutually exclusive and cannot be used together. In the implementation shown in **Fig. 14A**, the alignment control must operate when the pen is on the screen, for it constrains horizontal wobbling during the scrolling operation. In the implementation shown in **Fig. 14B**, the vertical alignment control must operate only after the user lifts the pen off the display, see page 15, lines 18-19, for it does not suppress horizontal wobbling during scrolling.

72. The lowest black arrow indicates the user’s final movement before liftoff, translating column **1220** up and slightly to the left in display **1205** (which **Fig. 14B** of **Lira**, reproduced above in Illustration **XIII**, depicts as display **1205** moving down and slightly to the right over webpage **1210**). The large white horizontal arrow illustrates the operation of the alignment control when it is enabled at liftoff at the end of scrolling, when it operates to “snap” column **1220** in the display to the center of display window **1205** in the manner taught for the alignment control implementation of **Fig. 14B**.

73. **Lira** does not disclose the ability to display any area beyond the edge of a webpage or beyond the edge of some other electronic document. Furthermore, one of ordinary skill in the art at the time of the ‘**381** invention would not have expected or understood devices such as the touch-screen display, and browsers such as the AOL Browser shown in **Lira**, to allow areas beyond the edge of the webpage document to be displayed. Indeed, **Lira** never executes any translation functionality in reference to a column boundary. The alignment control executes its re-centering functionality for any horizontal wobble (at least if it is below a threshold), whether or not any boundary of the column is reached, see **Lira** at page 14, line 29, to page 15, line 29.

74. After describing the “vertical alignment control” discussed above for Figs. 14A and 14B, **Lira** then describes a “horizontal alignment control” which operates analogously when the user wants to move horizontally (**Lira** at p. 16, lines 1-3):

A similar horizontal alignment control also may be provided. Such a control may be used to limit vertical movement when scrolling horizontally in, for example, a spreadsheet application.

75. However, **Lira** does not describe the use of the horizontal alignment control when moving vertically, or the use of the vertical alignment control when moving horizontally. That is, when moving vertically as in **Figs. 14A** and **14B** and therefore using the vertical alignment control, when the user reaches the bottom of the column, **Lira** is silent about what happens. One of ordinary skill in the art at the time the invention was made would expect that the user would simply continue moving down so the footer could be seen, and that nothing would occur in response to reaching a bottom of the column. Since the horizontal alignment control is described as being used when scrolling horizontally, one of ordinary skill in the art at the time the invention was made would understand that the horizontal alignment control is not used when scrolling vertically as in **Figs. 14A** and **14B**, and therefore would expect no vertical snapping behavior when moving vertically. Further, since, insofar as **Lira** discloses, the only way **Lira**'s "snapping" works is to snap the center of display window **1205** to the center of a column (**Lira** at page 15, lines 24-25), the horizontal alignment control would not be usable to snap vertically to a bottom of the column, since it would instead snap to the vertical center of the column – which not only would not make any sense, but also would be contrary to **Lira**'s teachings that the display should be keeping itself aligned to the content that the user intends to view.

III. A comparison of **Lira** and the '381 specification

76. In my opinion, based on my study of the **Lira** reference and the '381 patent discussed in detail in the paragraphs above, the disclosures of **Lira** discussed above have many differences with the invention in the issued '381 patent discussed above, and numerous features in the '381 claims are not disclosed by, or are even incompatible with, **Lira**. In the paragraphs below, I discuss these differences.

77. In order to more easily illustrate several points of difference between the issued '381 patent and **Lira**, a modified version of **Fig. 14B** of **Lira** is shown later below as Illustration **XV** clarified with additional annotations. This illustration is based on a combination of two modified versions of **Fig. 14B** found in the third party Request, reproduced immediately below in Illustration **XIV** and including annotations made by the requester.

78. In particular, the portions of the Request that are incorporated by reference in the office action, including Exhibit 6, Part A, pages 10 and 11, included two modified versions of **Fig. 14B** of **Lira**, reproduced below in Illustration **XIV**, having annotations purporting to indicate the 2nd and 3rd portions of the webpage and the "area beyond the edge":

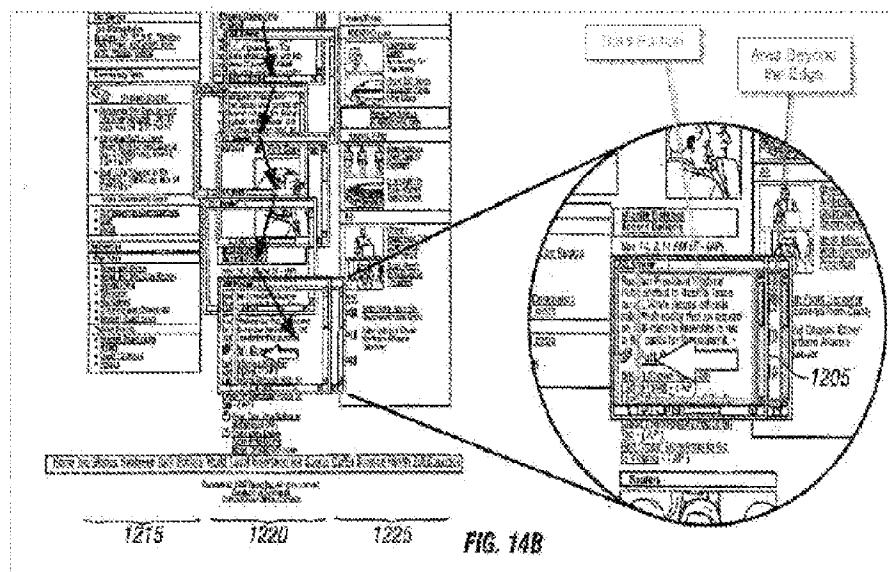
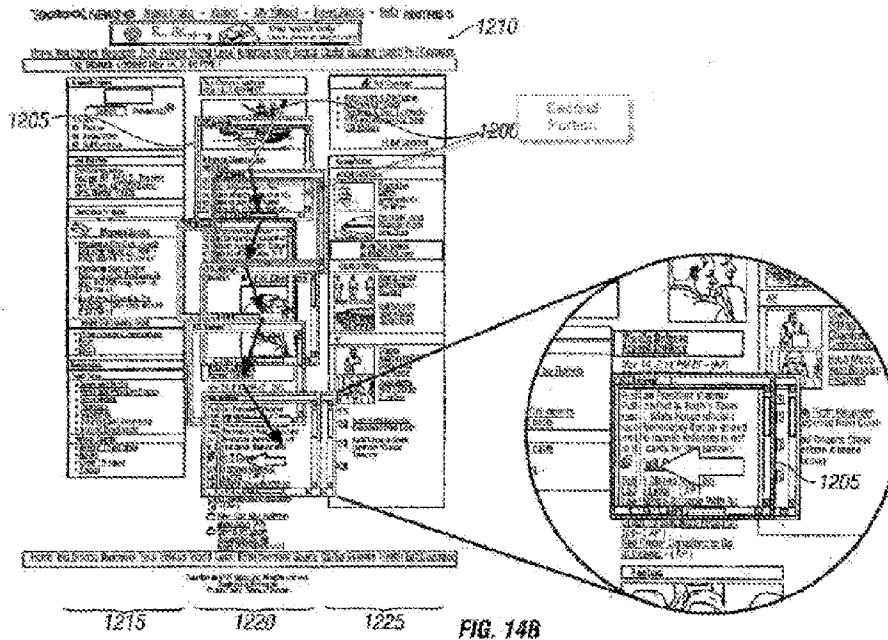

ILLUSTRATION XIV: modified versions of Fig. 14B of Lira in Reexamination Request

79. It is important to note that the rectangular box drawn by the requester to indicate the asserted “electronic document” is misleading, because, as discussed in paragraph 73 above, **Lira** never identifies these features as boundaries of an electronic document or indeed as boundaries for column **1220** or anything else. The precise configuration of the column in **Lira** is therefore at best unclear, except that, as explained in paragraph 55 above, the columns are said to be no wider than

display window **1205** and are each column abuts the next column because the webpage width is divided into columns as discussed in paragraphs 54-56, and shown in Illustration X (Lira Figs. 4A and 4B)

80. Illustration **XV**, below, is a sketch based on **Fig. 14B** of **Lira** which combines the markups from the Request above with several other annotations clarifying what is asserted, and with most of the right-hand column removed for clarity and to indicate column **1220** as an outside column as proposed by the examiner but would not function as proposed.

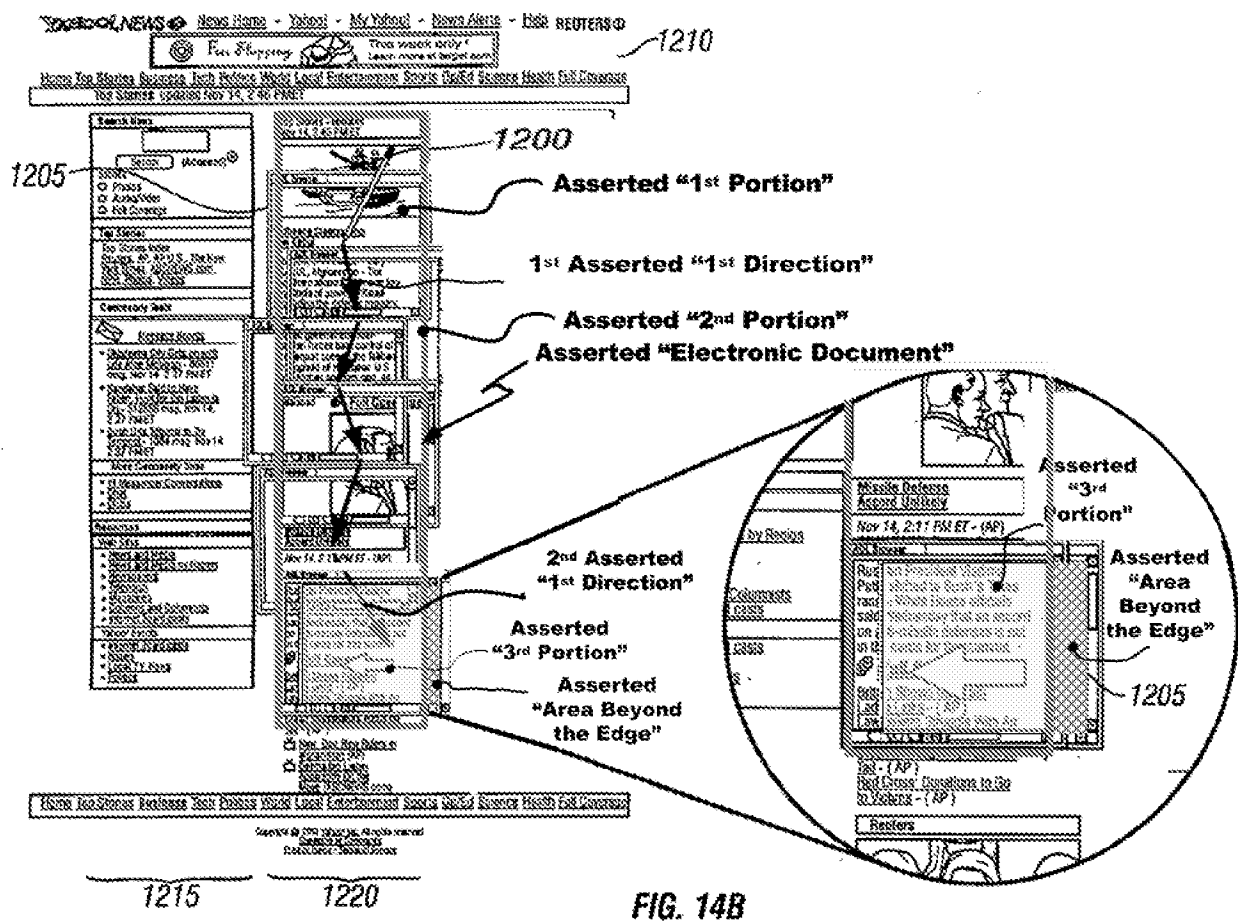

FIG. 14B
ILLUSTRATION **XV**: Sketch based on **Fig. 14B** of **Lira** with annotations

81. In particular, in Illustration **XV**, the area marked by the requester as the 2nd portion of electronic web page **1210** is marked "Asserted 2nd Portion" and a line, with a circular head-end, leads from the annotation to the asserted 2nd portion.

The area marked by the requester as the asserted “electronic document” in the Request, Exhibit 6, Part A, page 23, is outlined in gray, although this annotation by the Requester is once again misleading, since **Lira** does not show or identify the column’s boundaries and does not identify the column as a document.

82. The areas marked by the requester as the asserted 3rd portion, and asserted area beyond the edge, are illustrated with an added 50% light grey (or yellow) fill for clarity, even though these markings by the requester are again misleading, much like the requester’s markings of the column mentioned in the previous paragraph. The area marked as the asserted 3rd portion is also outlined and shown with partial yellow transparency in the exploded view at the right side of the figure.

83. In addition to the markings made by the requester, the arrows within column **1220** in the figure representing the movement by the user indicating the direction of translation, are also shown in this figure and are labeled as “1st asserted ‘1st direction’” (from the “asserted 1st portion” to the “asserted 2nd portion”) and the “2nd asserted ‘1st direction’” of translation (leading to the “asserted 3rd portion”).

84. Illustration **XV** helps clarify several of the differences I have found between the disclosures in **Lira** and the invention of the **‘381 patent**.

85. First, the ‘381 invention discloses a 3rd portion of the electronic document while translating the electronic document in the 1st direction, while the scrolling operation in **Lira Fig. 14B** does not display a 3rd portion of the electronic document (or even a 3rd portion of a logical column) while being translated in the 1st direction. The web page in **Lira Fig. 14B** has been translated in several different directions between the display of the 2nd and 3rd portions, and is not continuing in the first direction. Webpage **1210**, including the portion of that webpage which is formatted as column **1220**, is being translated in a different, perhaps 5th, direction to display the alleged 3rd portion in **Lira** (see the black arrows indicating translation directions in Illustration **XV** above). Note that the direction of the arrow labeled “1st Asserted ‘1st Direction’” leading to the display of the “Asserted ‘2nd Portion’” is not the same

as the direction of the arrow labeled “2nd Asserted ‘1st Direction’” leading to the display of the “Asserted ‘3rd Portion’”.

86. Moreover, several direction changes or additional translations occur between the two “Asserted ‘1st Direction[s].” Thus, the display of the “Asserted ‘3rd Portion’” does not occur in the course of the translation in the “1st Asserted ‘1st Direction’” that led to the display of the “Asserted ‘2nd Portion’”.

87. Second, in the ‘381 patent, the 3rd portion of the electronic document displayed while translating in the first direction while the user’s finger or other object is still detected, is smaller than the 1st portion of the electronic document displayed earlier in that translation, while in **Lira** the 3rd portion and the 1st portion of the electronic document are the same size. In the issued ‘381 patent, the 3rd portion of the document displayed is smaller than the 1st portion of the document displayed, because part of the area included within the display window is an area *beyond the edge* of the document. In **Lira**, everything that is in display window **1205** is still part of the “electronic document” **1210**.

88. The asserted “3rd portion” so labeled by the requester on **Fig. 14B** of **Lira**, see Illustrations **XIV** and **XV** above, is merely the sub-portion of the displayed portion of document **1210** that is part of the logical column. In fact, everything in the display window is part of document **1210**. Thus, the size of the portion of document **1210** that is displayed here is the same size as the portions of document **1210** displayed in **Lira** Sketches **(e)** and **(f)** respectively, and is not smaller than, for example, the “Asserted ‘1st Portion’” of the document labeled in Illustration **XV**.

89. Third, in the ‘381 patent, an edge of the electronic document is reached, while in **Fig. 14B** of **Lira**, an edge of the electronic document is not reached. Specifically, in **Fig. 14B** of **Lira**, column **1220**, according to **Lira** itself, is not itself an electronic document. See **Lira** at pages 1-2 and paragraphs 55-64 above. In fact, **Lira** teaches that the columns may be formed by reformatting a webpage, and furthermore are resizable, so that their width may be resized to be no wider than that of the display and the content of the columns are merely reformatted portions

of webpage electronic document **1205**, see, e.g., **Lira** at pages 1-2. Nothing in this activity would result in column **1220** itself being or becoming its own document. As noted in paragraphs 55-64 above, reformatting portions of a webpage into columns does not create separate or embedded electronic documents, any more than reformatting portions of a word processing file into columns would create separate or embedded electronic documents.

90. Fourth, in the '381 patent, an edge of the electronic document is outside the display and is then reached during the translation operation, while in Fig. 14B of Lira, even the asserted "internal edge" must already be in the display when translation begins and therefore cannot be reached during the translation operation. In the '381 patent, the scrolling in a second direction is in response to an edge of the document being reached while translating in the first direction. However, in **Lira**, the entire translation takes place within the area of web page **1205**, and **Lira** does not even mention the edges of the document, let alone change the direction of translation in response to reaching them. And even if logical column **1220** of web page **1205** were itself a document, the entire width of the column – especially including the right hand boundary – starts out being displayed, and the right boundary continues to be displayed throughout the scroll, and therefore can never be said to be "reached" as part of the translation.

91. Fifth, in the '381 patent, the area beyond the edge reached is an area outside or beyond the electronic document, while in Lira, the area beyond the column is merely the contiguous adjacent area that is, at most, another part of the same electronic document.

92. Sixth, in the '381 patent, the area beyond the edge of the electronic document is displayed in response to (among other necessary conditions) the edge of the electronic document being reached; while in Lira, nothing is disclosed as being displayed in response to any edge being reached, but only in response to translation. Process **700** in **Fig. 7** of the '381 patent, as discussed above and reproduced in Illustration **V**, teaches two possible actions dependent upon whether

or not the edge is reached. In particular, determination step **710** determines if the edge is reached and branches to the “**No**” path to step **712** if the edge has not reached display **112**. In response to the edge being reached, the process branches to the “**Yes**” path to display both a 3rd portion of webpage **3912** as well as the area beyond the edge. However, in **Lira**, translation in a particular direction merely and automatically displays any area of webpage **1210** contiguous with the area previously displayed, whether or not any “edge” of the column is reached. **Lira** nowhere even suggests that its displaying of an area beyond column **1120** is anything more than the automatic displaying of a further portion of translated webpage **1210**, regardless whether or not the boundary of column **1220** reaches display **1205**.

93. Seventh, in the ‘381 patent, in response to liftoff, the electronic document translates in a 2nd direction until the area beyond the reached edge of the document is no longer displayed, while in **Lira**, in response to liftoff, the display at most aligns with the column regardless of whether it results in an “area beyond” the column no longer being displayed. In the ‘381 patent, in response to liftoff, webpage **3912** is translated in a 2nd direction until the area beyond the edge being reached is no longer displayed, see ‘381 patent, col. 27, lines 40-44. That is, in response to liftoff, webpage **3912** is translated to a position in which the edge, beyond which the area beyond the edge of the document was displayed, is positioned at the edge of display **1205**, see ‘381 patent, **Fig. 8C**. However, in **Lira**, liftoff results in column **1220** being re-centered in display window **1205** regardless of whether any column boundary is reached, see **Lira**, page 15, lines 18-21. As already noted in paragraph 73 above, **Lira** never defines any response to reaching a column boundary, and its alignment control re-centers whether or not any such column boundary is reached. Still further, because the width of the column may be less than the width of the display, the area beyond the “internal edge” of the column, wherever located, *remains* displayed in Illustration **XV**, so that **Lira**, even as proposed by the examiner, still does not disclose that translation in the second direction is continued until the area beyond the column is no longer displayed.

94. In summary, after reviewing **Lira** in detail and comparing it to the various features to the '381 patent, in my opinion there is little valid correlation between these patents, because, among other things, **Lira** does not disclose an area beyond an edge of an electronic document; or, in response to that edge being reached while translating in a first direction, displaying that area beyond the edge or displaying a smaller portion of the electronic document than at the start of the translation; or, in response to no longer detecting the user's finger, translating in a second direction until the area beyond the edge is no longer visible.

IV. The Ording '975 Disclosure

95. **Ording '975** discloses an approach to scrolling a list of information in which scrolling may be accelerated in response to an accelerated movement of the point of contact on a touch screen display. In some embodiments, a direction of the scroll may be reversed in response to the scrolling list intersecting a virtual boundary corresponding to a terminus of the list, see, e.g., **Ording '975** col. 2, lines 7-11 and col. 6, lines 57-62.

96. While **Ording '975** mentions the beginning and end of lists, and the first item and last item of lists, **Ording '975** never identifies a beginning or end of a list or a first or last item of a list in any of its drawings.

97. In **Ording '975**, the scrolling of the list of items may correspond to a simulation of a cylinder rotating about its axis, see col. 4, lines 6-13 (emphasis added):

In some
embodiments, the scrolling and acceleration of the scrolling
may be in accordance with a simulation of a physical device
having friction, i.e., damped motion. For example, the scroll-
10 ing may correspond to a simulation of a force law or equation
of motion having a mass or inertial term, as well as a dissi-
pative term. In some embodiments, the simulation may cor-
respond to a cylinder rotating about its axis.

98. This simulation corresponding to a cylinder rotating about its axis describes a list similar to numerous lists currently available to my knowledge on commercial touch screen devices, such as the way the time of day is selected on Apple's iPhone, where, during scrolling, the last item in display order on the list will be followed by recommencing display of the earlier list items, beginning with the first item in display order, and vice versa. Such a list may be scrolled endlessly without ever reaching any point where no more list items are available to display.

99. As noted, **Ording '975** describes a scrolling reversal where the direction of scrolling a list may reverse when the scrolling list intersects a virtual boundary corresponding to a terminus of the list. For example, a displayed portion of the list may appear to bounce off a boundary of the display window when a beginning or end of the list of items is reached, see col. 4, lines 44-51 (emphasis added):

The direction of scrolling through the list of items may be
 45 reversed in response to the scrolling intersecting a virtual
 boundary corresponding to a terminus of the list. The scroll-
 ing reversal may correspond to a damped motion. For
 example, during scrolling, a displayed portion of the list of
 items may appear to bounce off of a boundary of the window
 50 in the touch-sensitive display when a beginning or an end of
 the list of items is reached.

100. In **Ording '975**, the terminus is a virtual boundary associated with the displayed objects of the list, as opposed to a physical boundary associated with the display or display window, see col. 9, lines 18-21; **Figs. 7A-7C**. In **Ording '975**, it appears that the "terminus" does not scroll with the list, and is not itself the beginning or the end of the list or an item on the list. The distances between the list items and the terminus vary as the list scrolls, and the list items may reach or intersect with the terminus, see col. 9, lines 15-35; **Figs. 7A-7C**.

101. **Ording '975** further discloses that, after the direction of scrolling through the list of items is reversed in response to the scrolling intersecting a virtual boundary corresponding to a terminus of the list, the scrolling reversal may correspond to a damped motion, see col. 4, lines 44-47.

102. **Fig. 1** of **Ording '975** is a flow diagram illustrating an embodiment of one method of scrolling through a list. In reference to this method, **Ording '975** states that when “[a] list of items on the touch-sensitive display is scrolled in response to the movement (**112**)” (col. 6, lines 50-51) a number of other operations may occur, including that “when the list is scrolled to its beginning or end, the scrolling list may appear to bounce again at a boundary and reverse direction”, see col. 6, lines 60-63.

103. In the next sentence, **Ording '975** states that, “After the bounce or scrolling operation reversal, the scrolling may automatically stop so as to leave the first or last item of the list in view on the touch-sensitive display”, see col. 6, lines 63-65. This operation is not shown in **Fig. 1**, and **Ording '975** does not identify this operation in any other figure.

104. Later, **Ording '975** states that “**Figs. 7A-7B** illustrate the scrolling of a list of items to a terminus of the list, at which point one or more displayed items at the end of the list smoothly bounce off the end of the display, reverse direction, and then optionally come to a stop” (col. 9, lines 9-12). The list includes “[o]ne or more displayed objects such as information object **612-1**” (col. 9, lines 16-17), which may “reach or intersect with the terminus **714**” in **Fig. 7B**, at which time “the movement corresponding to the scrolling may stop,” and “the information [sic] **612-1** may subsequently reverse direction”, see col. 9, lines 9-27 (emphasis added):

FIGS. 7A-7B illustrate the scrolling of a list of items to a terminus of the list, at which point one or more displayed items at the end of the list smoothly bounce off the end of the display, reverse direction, and then optionally come to a stop. FIG. 7A is a schematic diagram illustrating an embodiment of a user interface of a portable electronic device 600 having a touch-sensitive display. One or more displayed objects, such as information object 612-1 may be a distance 712-1 from a terminus 714 of the list of items and may be moving with a velocity 710-1 while the list is being scrolled. Note that the terminus 714 is a virtual boundary associated with the displayed objects, as opposed to a physical boundary associated with the window 610 and/or the display 608. As illustrated in FIG. 7B, when the one or more displayed objects, such as the information object 612-1, reach or intersect with the terminus 714, the movement corresponding to the scrolling may stop, i.e., the scrolling velocity may be zero at an instant in time. As illustrated in FIG. 7C, the one or more displayed objects, such as the information 612-1, may subsequently reverse direction.

105. I understand that the requester of this reexamination has asserted that **Ording '975** discloses that information item 612-1 in **Figs. 7A-7C** is the first item of a list of items and that the area of the display above information item 612-1 is an area beyond the list of items. In my opinion, both assertions are incorrect. **Ording '975** indicates that there are additional displayable items both above and below information item 612-1. And, even if information item 612-1 were the first item in the list, it is consistent with **Ording '975's** disclosure for the area above it to contain additional displayable items in the list.

106. In **Figs. 7A-7B**, **Ording '975** utilizes a drafting convention of three vertical dots, which I will call an "ellipsis". Similar ellipses also appear in **Figs. 6** and **11A-E**. A comparison of these figures and their corresponding descriptions clarifies that the ellipses in **Ording '975's** drawings indicate additional displayed objects.

107. In **Figs. 11A-11E**, information items in an alphabetical list are displayed as subsets based on their starting letters in the alphabet, with their starting letter appearing as an index symbol to the left of that subset, see col. 10, line 59 to col.

12, line 16. If no items on the list start with a particular letter, in this case 'I', that letter does not appear to the left of the information items. See for example, illustration **XV** of **Fig. 11E** and col. 12, lines 9-16 (yellow emphasis added):

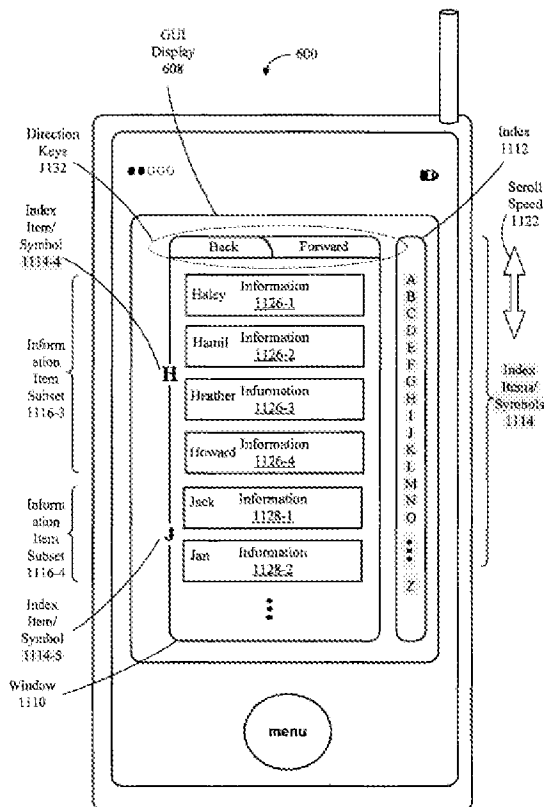

Figure 11E

Illustration **XV**: Sketch of **Ording '975**, **Fig. 11E**, highlighting added

In some embodiments, one or more of the index item/
 10 symbols **1114** may not be displayed, i.e., may be skipped, if
 the corresponding one or more of the information item sub-
 sets **1116** are empty, i.e., do not contain any information
 entries. This is illustrated in **FIG. 11E**, in which an index
 item/symbol for the letter 'I' has been skipped. Index item/
 15 symbols **1114-4** and **1114-5** are displayed since there is cor-
 responding information **1126** and **1128**.

108. On the right side of these figures, index **1112** displays the alphabet beginning with 'A' and ending with 'Z'. Letters 'P' to 'Y' are not depicted in index **1112**; instead, an ellipsis is depicted between letters 'O' and 'Z'. However, this ellipsis does not indicate that letters 'P' to 'Y' are not displayed in index **1112**.

Rather, in accordance with **Ording '975**, index **1112** does not omit any letters of the alphabet. (The letter 'I', for example, is displayed at its alphabetical place in alphabetical index **1112** even though **Ording '975** omits this letter on the left side of the figure because the information subset for the letter 'I' does not contain any information entries.) The ellipsis is clearly substituted to make clear in the limited space available that the index contains all the letters from 'A' to 'Z'.

109. It follows that the similar ellipses in **Figs. 6, 7A** and **7B**, similarly indicate additional displayed items. For example, in **Fig. 6**, information objects **612-1** through **612-4** are depicted, and ellipses above information object **612-1** and below object **612-4** indicate additional displayed information objects, see col. 8, lines 54 to 59. Similarly, in **Figs. 7A** and **7B**, which "illustrate the scrolling of a list of items," see col. 9, lines 9 to 36, only one of the "items" is depicted in the figures, but the ellipsis above information object **612-1** indicates additional items.

110. Thus, **Ording '975** does not disclose that information item **612-1** is the first item in the list of items in **Figs. 7A-7C**.

111. However, even if information item **612-1** were the first item in the list of items, the area of the display above information item **612-1** may, consistent with **Ording '975**'s disclosure, contain additional items in the list. For example, as already discussed above, **Ording '975** discloses that the list of items could correspond to a simulation of a cylinder rotating about its axis. In that event, the last item on the list could appear immediately above the first item on the list, followed above it by the penultimate item on the list, and so on. Such a possibility is shown in illustration **XVI** below, which includes a list corresponding to a simulation of a cylinder rotating about its axis, and a sketch based on **Fig. 6A** of **Ording '975** that depicts a possible display of such a list in the display window:

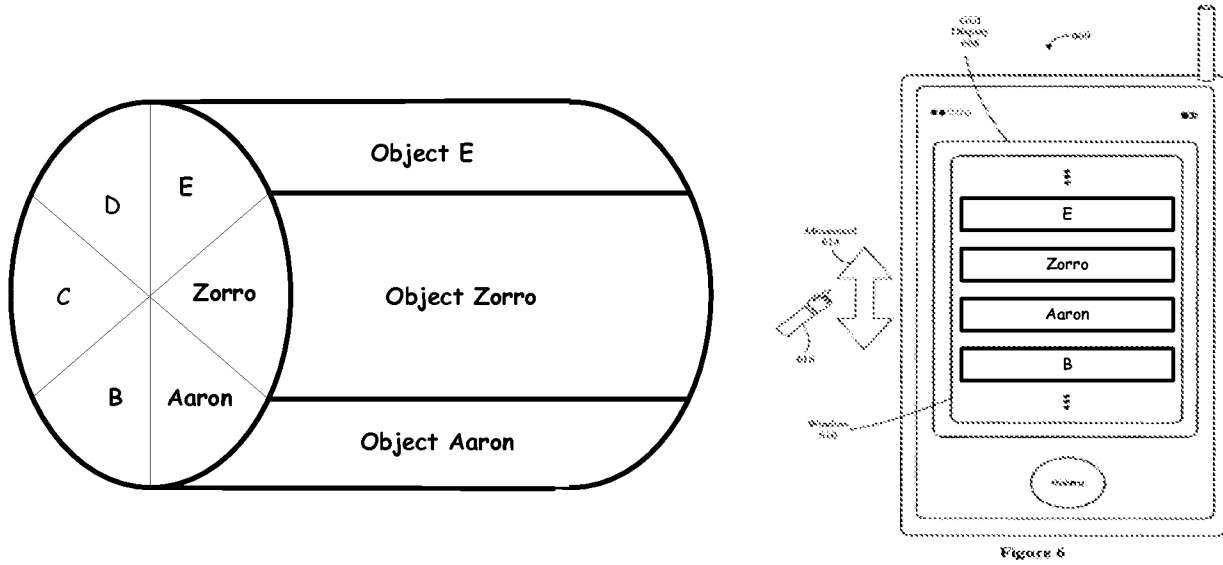

ILLUSTRATION XVI:
Sketch of axial rotating cylindrical list, and modified version of **Fig. 6A of Ording '975**

V. Comparison of Ording '975 and the issued '381 patent.

112. Illustration **XVII** below helps clarify some of the numerous differences between **Ording '975** and the invention of the issued **'381** patent:

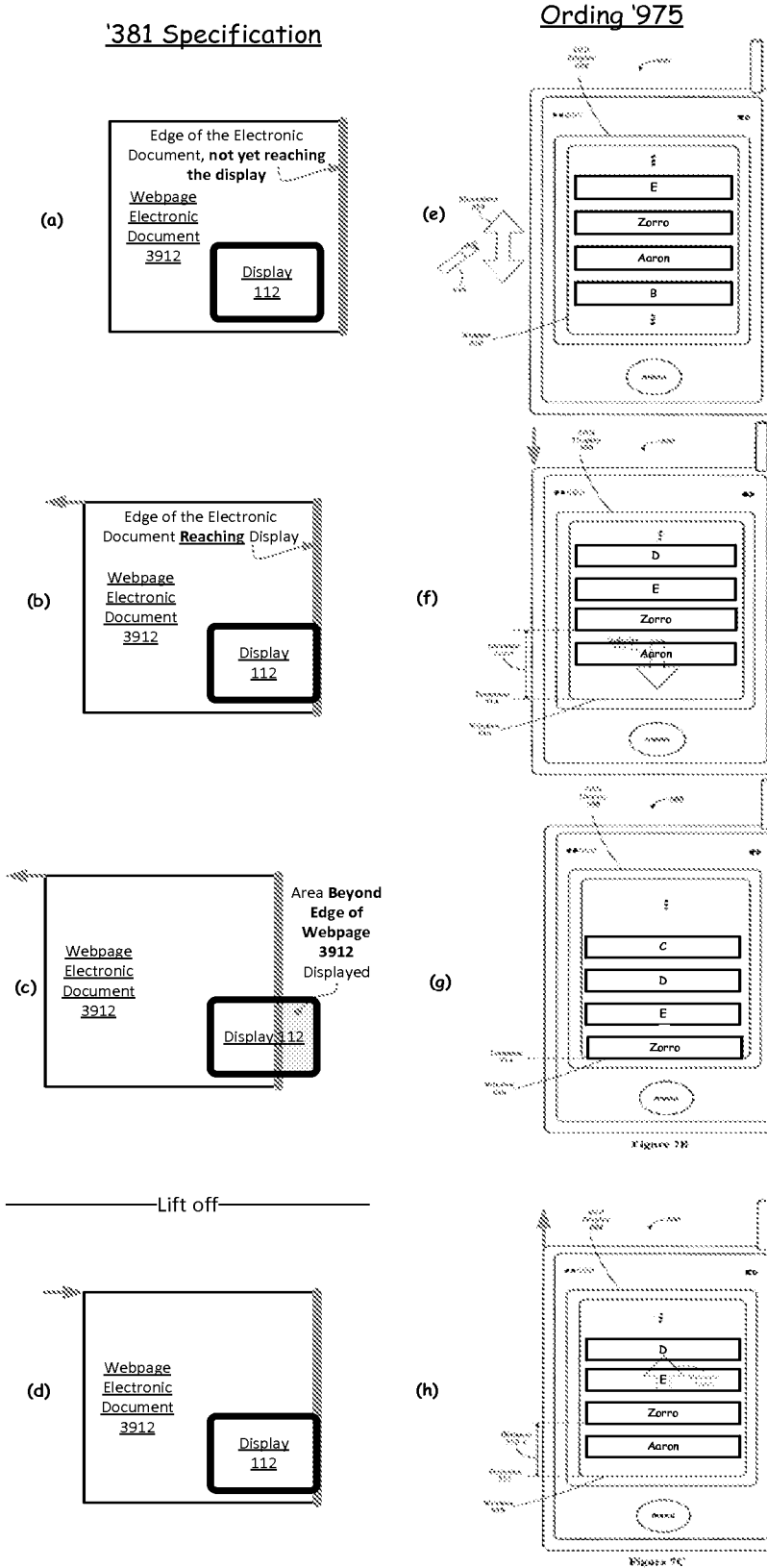

ILLUSTRATION XVII: Comparative sketches of '381 and Ording '975

113. In '381 sketches (a) – (d) in Illustration **XVII** above, based on '381 Figs. 8A-D, the edge of webpage electronic document **3912** to be reached is highlighted as a thick grey line while touch screen display **112** is shown as a thick black, rounded rectangle.

114. In '381 Sketch (a) in Illustration **XVII**, a 1st portion of webpage electronic document **3912** is displayed on touch screen display **112**. The right hand edge of webpage **3912** is shown highlighted in grey and is the edge of webpage **3912** beyond which – when reached – an area beyond the displayable portions of webpage **3912** will be displayed.

115. In '381 Sketch (b), webpage **3912** is being translated in a 1st direction (to the left as indicated by the grey arrow at the upper left of the webpage) to display the 2nd portion and the edge of webpage **3912** is being reached in display **112**.

116. In '381 Sketch (c), webpage **3912** has been translated further in the 1st direction and an area beyond the (grey highlighted) outside edge of webpage **3912** is displayed (filled with yellow/light grey), together with a 3rd portion of webpage **3912**, in touch screen display **112**. The 3rd portion of webpage **3912** must be smaller than the 1st portion of webpage **3912**, because the 1st portion filled display **112**. That is, the 3rd portion is smaller than the 1st portion because it must share touch screen display **112** with the display of some area beyond document **3912**.

117. In '381 Sketch (d), webpage **3912** has been translated in a 2nd direction until the area beyond the outside edge of webpage **3912** is no longer displayed.

118. As illustrated above in Sketch (f) of Illustration **XVII**, **Ording '975** discloses that one or more displayed objects, such as information object **Zorro** (*i.e.*, information object **612-1** in **Fig. 7**) may be a distance **712-1** from terminus **714** of the list of items, and may be moving in a first direction with a velocity **710-1** while the list is being scrolled. As illustrated in Sketches (f) – (h) of Illustration **XVII**, terminus **714** is a virtual boundary associated with information object **Zorro**, just

as, in **Figs. 7A-7C**, terminus **714** is associated with information item **612-1**, see **Ording '975**, col. 9, lines 14-92.

119. In sketch **(f)** of Illustration **XVII**, corresponding to **Fig. 7A**, object **Zorro** is scrolling downward and is at a distance **712-1** from terminus **714** at the bottom of window **610**.

120. In sketch **(g)**, corresponding to **Fig. 7B**, object **Zorro** has stopped scrolling and is at a zero distance from terminus **714** at the bottom of window **610**.

121. Finally, in sketch **(h)**, corresponding to **Fig. 7C**, the scrolling direction has reversed, and object **Zorro** is scrolling upward at a velocity **710-2**, at a distance **712-2** from terminus **714** at the bottom of window **610**.

122. Consistent with **Ording '975**, other items in the list may be displayed below item **Zorro**. For example, if the list corresponds to a simulation of a cylinder rotating about its axis, object **Aaron** at the beginning of the list could be displayed below object **Zorro**, as shown in sketch **(h)**.

123. The above comparison helps illustrate some of the numerous differences I see between what the '**381** describes and claims and what **Ording '975** discloses.

124. First, the "bounce" operation in **Ording '975** is entirely different from the rubberband-like behavior of the '**381** patent. **Ording '975** mentions in one embodiment a "beginning or an end of the list of items" that may be "reached," col. 4, lines 47-51. When this "beginning or an end of the list of items is reached," "a displayed portion of the list of items may appear to bounce off of a boundary of the window in the touch-sensitive display," col. 4, lines 47-51. Such behavior is entirely unlike the rubberband-like behavior of the '**381** patent, which permits the document to continue translating in the first direction after the edge of the document is reached, and only later translate in a second direction until the area beyond the edge is no longer visible. This "bounce" operation in **Ording '975**, in contrast, would prevent any area beyond the list from being seen, by reversing the scrolling before any such area, if it existed, could reach the display.

125. Second, in the '381 patent, an area beyond the edge of the document is displayed in response to (among other necessary conditions) the edge being reached, while in **Ording '975**, no area beyond the edge of any document or list is even mentioned, let alone displayed in response to anything.

126. Third, in the '381 patent, the 3rd portion of the electronic document displayed while translating in the first direction is smaller than the 1st portion displayed earlier in the same translation, while in **Ording '975** the supposed 3rd portion and 1st portion are the same size. In every display of list items in **Ording '975**, it would be consistent with the disclosure for the entire display to be filled with displayed list items, in which case the various portions of the list that are displayed as the list is scrolled are all the same size as the display.

127. Fourth, in the '381 patent, the electronic document translates in a 2nd direction in response to finger liftoff, while in **Ording '975**, scrolling continues or even accelerates in response to finger liftoff. In **Ording '975**, reversal of scrolling direction is disclosed to occur when, and only when, a distance between the virtual boundary (corresponding to a selected terminus) and a related information object goes to zero. In short, reversal is said to occur when the scrolling list intersects a virtual boundary corresponding to a terminus. There is no indication that the **Ording '975** scrolling reversal has anything to do with whether the finger is still touching the display or even whether it is still moving. Rather, the scrolling reversal simply occurs whenever the list scrolls to a certain definable point.

128. Indeed, **Ording '975** does not disclose changing the direction of scrolling in response to lifting a finger or pen from the display in any circumstances. To the contrary, **Ording '975** discloses in great detail that when a finger is lifted from a screen, the list continues to “scroll[] after [the] user . . . breaks the contact,” col. 7, lines 21-24, see also col. 1, lines 58-61 and col. 4, lines 34-43, and optionally may even be made to accelerate, see col. 4, lines 14-26, col. 6, lines 52-54.

129. **Ording '975** further discloses that in some embodiments the scrolling that continues after the user breaks the contact can be “stopped” by a separate,

subsequent gesture, i.e., “establish[ing] a substantially stationary point of contact with the touch-sensitive display”, col. 6, line 65 to col. 7, line 1, col. 7, lines 21-22. However, such a stopping of scrolling results from the finger touching the display, not from the finger lifting off of the display, and does not in any way resemble the behavior described and claimed in the ‘**381** patent, in which the scrolling reverses or changes direction in response to liftoff.

130. Fifth, in the ‘**381** patent, the electronic document translates in a 2nd direction until the area beyond the reached edge of the document is no longer visible, while in **Ording** ‘**975**, the scrolling reversal continues, dampens, or stops with a first or last item visible, irrespective whether any particular area that is not part of the list is no longer visible. As noted above, **Ording** ‘**975** does not disclose displaying an area beyond an edge of the list, or changing the direction of scrolling in response to liftoff. But even assuming it did for the sake of argument, **Ording** ‘**975** does not disclose that scrolling in the changed direction would continue until the supposed area beyond the edge of the list is no longer visible. **Ording** ‘**975** discloses that after the reversal of scrolling which occurs when one or more displayed items at the end of the list bounce off the end of the display, the displayed items may “then optionally come to a stop,” but it does not say or show *where* they may optionally come to a stop, see col. 9, lines 9-12; **FIGS. 7A-7C**. It also says that the motion of the objects may be “damped” after the scrolling list reaches and bounces at its terminus, but it does not state that any particular area will no longer be visible, see col. 8, lines 47-49; col. 9, lines 30-35.

131. **Ording** ‘**975** further states that such damping may be “adjustable, allowing the ball to reach equilibrium in contact with the wall, i.e., the virtual boundary, or displaced from the wall”, see col. 4, lines 57-59, but with no accompanying figure showing such behavior. However, once again, there is no disclosure that this behavior of the “ball” vis-à-vis the “wall” will result in any particular area being no longer visible, let alone an area beyond the edge of an electronic document.

132. In summary, after reviewing Ording '975 in detail and attempting to compare it to the various features of the '381 patent, in my opinion, there is little if any correlation between these patents because, among other things, Ording '975 does not disclose an area beyond the edge of a document/list; displaying that area in response to that edge being reached; or ceasing to display that area or even reversing the scrolling direction in response to the user's finger no longer being detected.

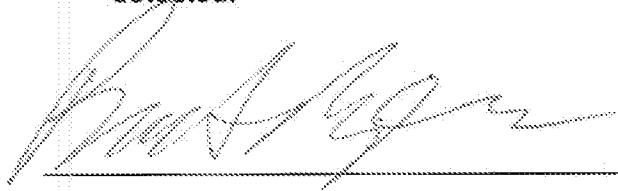

1/14/2013

Brad A. Myers, PhD

Date

IN THE UNITED STATES PATENT AND TRADEMARK OFFICE

In re: Reexam of U.S. Patent No. 7,469,381 B2

Control No. 90/012,304

Filed: May 23, 2012

For: **LIST SCROLLING AND
DOCUMENT TRANSLATION,
SCALING, AND ROTATION ON A
TOUCH-SCREEN DISPLAY**

Confirmation No.: 4807

Art Unit: 3992

Examiner: Bonshock, Dennis G

Atty. Docket:

P4304USREX2/120730-002US

Certificate of Service

Mail Stop *Ex Parte* Reexam
Central Reexamination Unit
Commissioner for Patents
United States Patent and Trademark Office
P.O. Box 1450
Alexandria, VA 22313-1450

January 15, 2013

Sir:

In compliance with 37 C.F.R. § 1.550(f), the undersigned, on behalf of the Patent Owner, hereby certifies that copies of the following documents are being served on the Third Party Requester by first class mail on January 15, 2013.

1. Patent Owner's Response to Non-Final Office Action with Exhibit 1
2. Declaration Under 35 U.S.C § 132 of Prof. Brad A. Myers, Ph.D. with Exhibit 1
3. Declaration of Bas Ording Under 37 CFR § 1.131 with Exhibits A-I
4. Declaration of Greg Christie Under 37 CFR § 1.131 with Exhibit A
5. Certificate of Service

The name and address of the party being served is as follows:

Joseph J. Richetti
BRYAN CAVE LLP
1290 Avenue of the Americas
New York, New York 10104

Very truly yours,

/Kenneth J. Weatherwax/

Kenneth J. Weatherwax, Reg. No. 54,528
Goldberg, Lowenstein & Weatherwax LLP
11400 W. Olympic Blvd., Suite 400
Los Angeles, CA 90064

IN THE UNITED STATES PATENT AND TRADEMARK OFFICE

| | | | |
|--|---|----------------------|-------------------------|
| In the Reexamination of USP 7,469,381: |) | | |
| |) | | |
| Inventor(s) : Bas Ordning |) | Art Unit: | 3992 |
| |) | | |
| Control No.: 90/012,304 |) | Examiner: | Bonshock, Dennis |
| |) | | |
| Filed : 5/23/2012 |) | Office Action dated: | 10/15/2012 |
| |) | | |
| For: LIST SCROLLING AND |) | | |
| DOCUMENT TRANSLATION, |) | | |
| SCALING, AND ROTATION ON A |) | | |
| TOUCH-SCREEN DISPLAY |) | | |

Response to Non-Final Office Action

Mail Stop Ex Parte Reexam
Central Reexamination Unit
Commissioner for Patents
United States Patent & Trademark Office
P.O. Box 1450
Alexandria, VA 22313-1450

Sir:

The following is a response to the Office Action dated October 15, 2012. It includes:

Claims beginning on page 2.

Remarks beginning on page 7 (including Exhibit 1 hereto).

Declaration of Bas Ordning under 35 U.S.C. § 131, discussed on and after page 56.

Declaration of Greg Christie under 35 U.S.C. § 131, discussed on and after page 56.

Declaration of Prof. Brad Myers, Ph.D. under 35 U.S.C. § 132, discussed on and after page 7.

In The Claims as Issued:

Claims 1-20 stand issued in USP 7,469,381, of which Claims 1, 19 and 20 are in independent form. Claims 1-20 are subject to reexamination. No claims have been amended or canceled.

1. (original) A computer-implemented method, comprising:
at a device with a touch screen display:
displaying a first portion of an electronic document;
detecting a movement of an object on or near the touch screen display;
in response to detecting the movement, translating the electronic document displayed on the touch screen display in a first direction to display a second portion of the electronic document, wherein the second portion is different from the first portion;
in response to an edge of the electronic document being reached while translating the electronic document in the first direction while the object is still detected on or near the touch screen display:
displaying an area beyond the edge of the document, and
displaying a third portion of the electronic document, wherein the third portion is smaller than the first portion; and
in response to detecting that the object is no longer on or near the touch screen display, translating the electronic document in a second direction until the area beyond the edge of the electronic document is no longer displayed to display a fourth portion of the electronic document, wherein the fourth portion is different from the first portion.

2. (original) The computer-implemented method of claim **1**, wherein the first portion of the electronic document, the second portion of the electronic document, the third portion of the electronic document, and the fourth portion of the electronic document are displayed at the same magnification.

3. (original) The computer-implemented method of claim **1**, wherein the movement of the object is on the touch screen display.

4. (original) The computer-implemented method of claim **1**, wherein the object is a finger.

5. (original) The computer-implemented method of claim **1**, wherein the first direction is a vertical direction, a horizontal direction, or a diagonal direction.

6. (original) The computer-implemented method of claim **1**, wherein the electronic document is a web page.

7. (original) The computer-implemented method of claim **1**, wherein the electronic document is a digital image.

8. (original) The computer-implemented method of claim **1**, wherein the electronic document is a word processing, spreadsheet, email or presentation document.

9. (original) The computer-implemented method of claim **1**, wherein the electronic document includes a list of items.

10. (original) The computer-implemented method of claim **1**, wherein the second direction is opposite the first direction.

11. (original) The computer-implemented method of claim **1**, wherein translating in the first direction prior to reaching an edge of the document has an associated speed of translation that corresponds to a speed of movement of the object.

12. (original) The computer-implemented method of claim **1**, wherein translating in the first direction is in accordance with a simulation of an equation of motion having friction.

13. (original) The computer-implemented method of claim **1**, wherein the area beyond the edge of the document is black, gray, a solid color, or white.

14. (original) The computer-implemented method of claim **1**, wherein the area beyond the edge of the document is visually distinct from the document.

15. (original) The computer-implemented method of claim **1**, wherein translating the document in the second direction is a damped motion.

16. (original) The computer-implemented method of claim **1**, wherein changing from translating in the first direction to translating in the second direction until the area beyond the edge of the document is no longer displayed makes the edge of the electronic document appear to be elastically attached to an edge of the touch screen display or to an edge displayed on the touch screen display.

17. (original) The computer-implemented method of claim **1**, wherein translating in the first direction prior to reaching the edge of the electronic document has a first associated translating distance that corresponds to a distance of movement of the object prior to reaching the edge of the electronic document; and wherein displaying an area beyond the edge of the electronic document comprises translating the electronic document in the first direction for a second associated translating distance, wherein the second associated translating distance is less than a distance of movement of the object after reaching the edge of the electronic document.

18. (original) The computer-implemented method of claim **1**, wherein translating in the first direction prior to reaching the edge of the electronic document has a first associated translating speed that corresponds to a speed of movement of the object, and wherein displaying an area beyond the edge of the electronic document comprises translating the electronic document in the first direction at a second associated translating speed, wherein the second associated translating speed is slower than the first associated translating speed.

19. (original) A device, comprising:

- a touch screen display;
- one or more processors;
- memory; and
- one or more programs,

wherein the one or more programs are stored in the memory and configured to be executed by the one or more processors, the programs including:

- instructions for displaying a first portion of an electronic document;
- instructions for detecting a movement of an object on or near the touch screen display;
- instructions for translating the electronic document displayed on the touch screen display in a first direction to display a second portion of the electronic document, wherein the second portion is different from the first portion, in response to detecting the movement;
- instructions for displaying an area beyond an edge of the electronic document and displaying a third portion of the electronic document, wherein the third portion is smaller than the first portion, in response to the edge of the electronic document being reached while translating the electronic document in the first direction while the object is still detected on or near the touch screen display; and
- instructions for translating the electronic document in a second direction until the area beyond the edge of the electronic document is no longer displayed to display a fourth portion of the electronic document, wherein the fourth portion is different from the first portion, in response to detecting that the object is no longer on or near the touch screen display.

20. (original) A computer readable storage medium having stored therein instructions, which when executed by a device with a touch screen display, cause the device to:

- display a first portion of an electronic document;
- detect a movement of an object on or near the touch screen display;

translate the electronic document displayed on the touch screen display in a first direction to display a second portion of the electronic document, wherein the second portion is different from the first portion,

in response to detecting the movement display an area beyond an edge of the electronic document and display a third portion of the electronic document, wherein the third portion is smaller than the first portion,

if the edge of the electronic document is reached while translating the electronic document in the first direction while the object is still detected on or near the touch screen display; and

translate the electronic document in a second direction until the area beyond the edge of the electronic document is no longer displayed to display a fourth portion of the electronic document, wherein the fourth portion is different from the first portion, in response to detecting that the object is no longer on or near the touch screen display.

REMARKS

The Office Action dated October 15, 2012 and the portions of the Request incorporated therein have been carefully reviewed. Issued Claims 1-6, 8-12, 16, 19, and 20 stand rejected under § 102(b) as being anticipated by WO 03/081458 A1, “**Lira**”. Issued Claims 7 and 13-15 stand rejected under § 103(a) as being obvious over **Lira**. Issued Claims 1-5, 7-13, and 15-20 stand rejected under § 102(e) as being anticipated by US 7,778,975 B2, “**Ording ‘975**”. Reconsideration and further examination are respectfully requested.

SUMMARY OF THE '381 PATENT

The '**381** patent relates in part to devices with touch screen displays and to translating electronic documents on such displays. The '**381** patent uses the phrase “electronic file” to refer to a digital file that contains display data for the display of an “electronic document having a document length and a document width, to be displayed on a touch screen display,” see col. 6, lines 18-21(emphasis added). The patent explains that because “electronic files” can be large, and the display screens of portable electronic devices can be small, frequently only a portion of a list or electronic document of interest to the user can be displayed at once, and this means users must translate the document or scroll the list on the small screen to see the entire document, see col. 2, lines 14-19.

As Professor Brad A. Myers of Carnegie-Mellon University, one of the preeminent scholars in the field of human-computer interaction and an expert in handheld touch screen device user interfaces, explains in his attached declaration under 37 C.F.R. § 1.132, a person of ordinary skill in the art reading the '**381** specification would not expect these “electronic documents,” as described above, to further include display data for the display of areas beyond the “document length” or “document width,” i.e., would not expect such electronic files which contain data for the display of “an electronic document having a document length and a document width, to be displayed on the touch screen display,” to further contain data for the display of areas beyond the edges of the electronic document having the particular document

length and document width so defined. Myers Decl. ¶¶ 22, 37. One reason for this is that although the electronic file may be a local file that is stored and can be modified on the device with the touch screen itself, it is often stored elsewhere and merely displayed on the touch-screen device. For example, web pages are often displayed on touch screen devices and are typically accessed from a remote location. The graphical user interface used to view such documents should ideally be able to operate in each of these possible circumstances. Myers Decl. ¶ 24. Thus, if an area beyond the edge of the electronic document is displayed, it is through some mechanism other than simply that of the electronic document being displayed according to its associated electronic file.

As already mentioned above, the '381 patent describes a problem to be solved related to translating large files on a small touch screen. The patent explains that when a user of a touch screen device must translate a document to view different portions of it on the display, if the translation does not reflect the user's intent the user may become frustrated, see col. 2, lines 26-28.

Professor Myers explains that this issue related to a

well-known problem that when a user of prior art devices translated a larger electronic document on a smaller touch-screen display device, the portion of the document in the display would occasionally stop moving. In particular, for example, where translation occurs in response to detecting the user moving an object (such as a finger) on or near the display, when an electronic document was translated by the user to a point of reaching a previously off-screen edge of the document, the display would effectively be pinned against that edge and appear to freeze because the device would cease to translate the document when the edge of the document was reached. This could frustrate the user, who might not realize why the translation stopped and might think that the device was not operating properly.

Myers Decl. ¶ 26 (citation omitted). Alternatively, the user might think that the pen or finger was no longer being detected. Id. ¶ 33. Professor Myers also notes the existence of another issue that is the corollary of the frozen screen problem. If content is not constrained at all and a user is permitted to scroll a document into nothingness and away from any meaningful content, he may become lost or disoriented in what is commonly referred to as "Desert Fog." Id. ¶¶ 15-16.

To solve this problem, the '381 patent teaches a method in which, in broad terms, an electronic document is translated in response to detected movement of an object such as a user's finger, and in response to reaching an edge of the displayable area of the electronic document during translation in a first direction, actions are taken which allow translation to continue and allow that edge of the electronic document to be translated onto the display and an area beyond the edge to be displayed, thus resulting in a display of a smaller portion of the document than before; after which, in response to detecting that the user has lifted his finger off the screen, action is taken to translate the electronic document in a second direction until the area beyond the edge is no longer displayed. Myers Decl. ¶¶ 35-38. The patent explains that this method "provides a simple visual indicator to a user that one or more edges of an electronic document are being displayed," col. 26, lines 65-67.

The '381 patent depicts process flow 700 of this solution in Fig. 7.

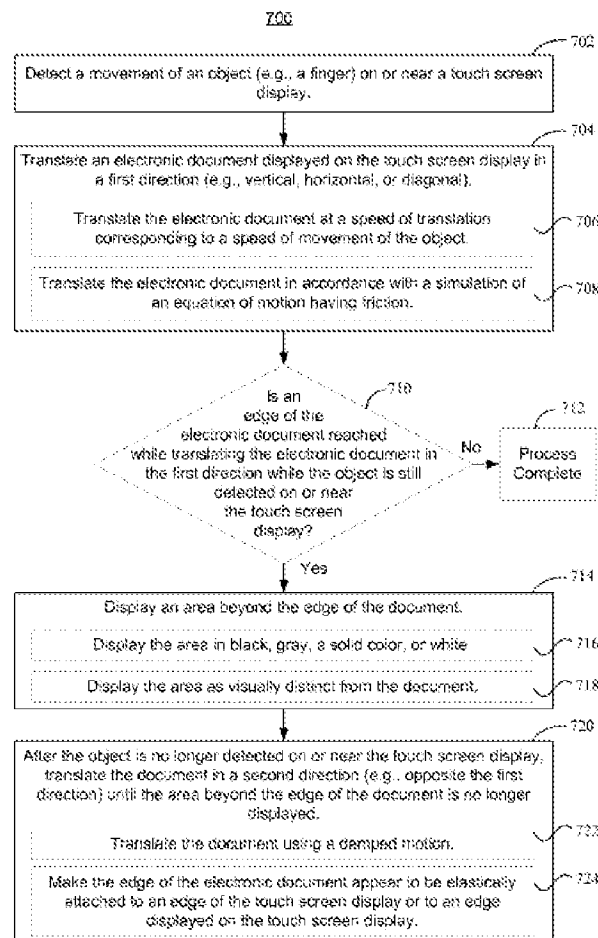

Figure 7

This process flow **700** is also depicted in **Figs. 8A-8D**, which “illustrate the translation of an electronic document to an edge of the document, at which point an area beyond the edge is displayed and the document is then translated in a second direction until the area beyond the edge of the document is no longer displayed,” col. 28, lines 34-38.

Process **700** of translating an electronic document begins with step **702**, in which movement of, e.g., the user’s finger on or near a touch screen is detected, such as the result of a user’s gesture, and a first portion of the electronic document is already displayed. This situation is depicted, for example, in **Fig. 8A** of the ’**381** patent, see col. 29, lines 15-30. **Fig. 8A** shows web page **3912**, which fills more than the area of the display window, and which contains “blocks **3914** of text content and other graphics (e.g., images),” including Block **1 (3914-1)** through Block **9 (3914-9)**, see col. 28, line 48 through col. 29, lines 18, Myers Decl. ¶ 42.

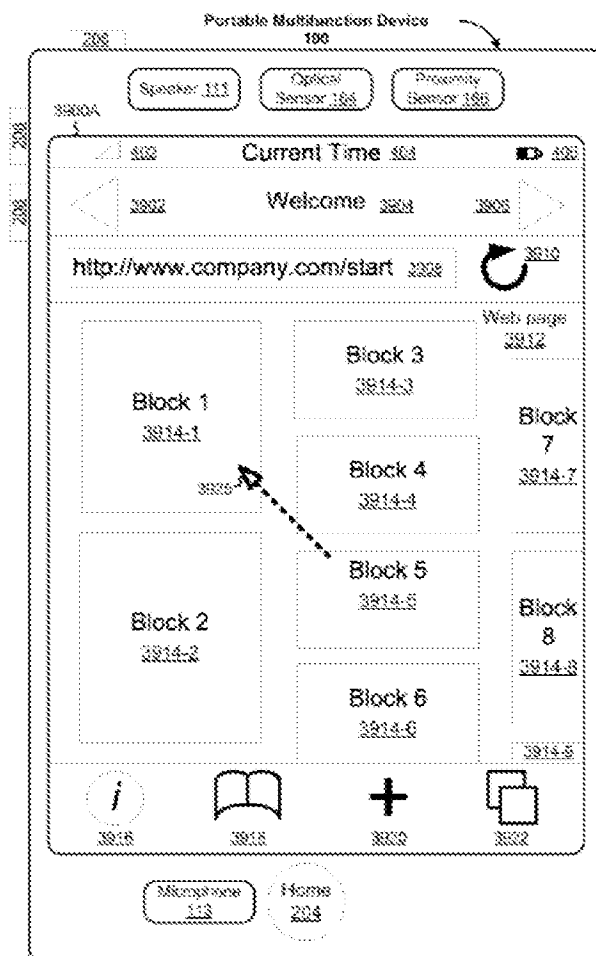

Figure 8A

The patent further explains that blocks **3914** may be determined by analyzing the web page's "render tree," and may correspond to various render modes, see col. 29, lines 10-14.

Notably, at step **702**, the bottom edge of the web page has not been reached, see col. 28, lines 15-16; and the bottom of block **9 (3914-9)** also has not been reached, see col. 29, lines 17-18.

In step **704**, the web page **3912** having blocks **3914** is translated in a first direction consistent with the gesture in step **702** and along a distance related to the movement detected in step **702**, to display a second portion of the electronic document.

The flow then moves to determination step **710**, which determines whether or not an edge of the electronic document is reached in the display, while translating in the first direction, and while the finger is still detected on or near the touch screen display. Myers Decl. ¶ 46.

If the result of that determination is negative (i.e., an edge of the document has not been reached with the conditions satisfied), the process flow **700** moves to the "No" path to step **712**, which is "Process Complete." The process **700** may be re-initiated upon detection of further movement, see col. 28, lines 27-33, Myers Decl. ¶ 44.

However, if while translating in the first direction and while the finger movement is still detected, step **710** detects an edge of the document being reached, then the Process **700** moves down the "Yes" path to step **714**, instructing that an area beyond the electronic document be displayed. Myers Decl. ¶¶ 45, 48. This results in a third, smaller portion of the web page being displayed. Myers Decl. ¶ 92.

Fig. 8B depicts the moment of a "Yes" determination in step **710**. **Fig. 8C** depicts results of the next step **714** of displaying an area beyond the edge of the document, showing that the area **3930** beyond the edge **3928-1** of the web page **3912** is displayed, see col. 27, lines 25-36, see col. 29, lines 52-58 (emphases added):

In **FIG. 8B**, block 9 (3914-9) is in the lower right-hand corner of the web page **3912**; both the bottom and right edges of the web page have been reached while translating the web page. Upon reaching these edges of the document, in response to continued detection of the upward gesture **3925**, an area **3930 (FIG. 8C)** beyond the bottom and right edges of the web page is displayed.

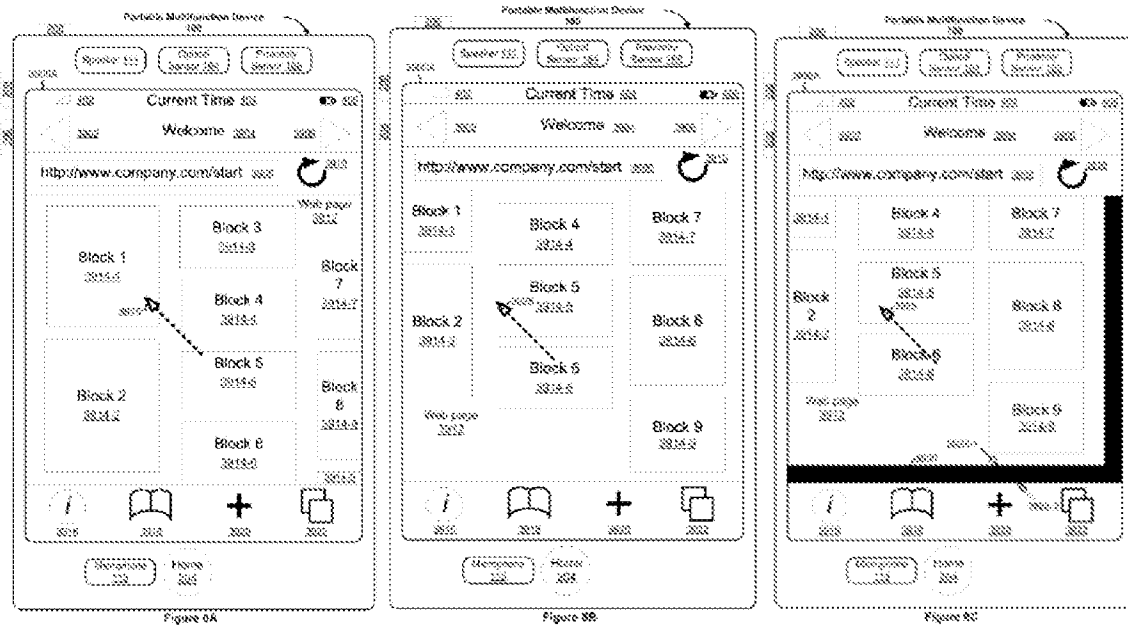

It is of interest to note not only when determination step 710 made a “Yes” determination, but when it did not. The progression of the translated web page 3912 in **Figs. 8A, 8B** and **8C**, shows that before the edge 3928-1 of web page 3912 was reached, the bottom of Block 9 (3914-9) was reached. When the boundary of Block 9 was reached, determination step 710 did not treat this event as an edge of a document being reached, and did not move to the “Yes” path of process 700 in **Fig. 7**. Movement to the “Yes” path did not occur until the edge 3928-1 of web page 3912 (to which the legend 3928-1 in **Fig. 8C** is pointed) was reached some time later. Myers Decl. ¶ 46.

It is noted that Block 9 (3914-9) is within the edges of the web page, and is expressly disclosed as possibly being an image or other embedded item, see col. 28, lines 62-64.

In sum, in process 700, step 710 responds as “True” when an edge of the document is reached, but not when a boundary of an internal image or other block is reached. Myers Decl. ¶¶ 46-50.

Returning now to process 700, after step 714 the flow continues to step 720. If liftoff of the finger is detected, webpage 3912 is translated in a second direction, until the area beyond the edge is no longer displayed, thus displaying a fourth portion of the web page that is different from the first portion, compare **Figs. 8A, 8D**. The second direction of translation may be opposite the first direction, see col. 29, line 64 to col. 30, line 10.

Similarly, process **500** and **Figs. 5** and **6A-6D** in the **'381** patent describe a similar process for providing a visual indicator to a user that a terminus of a list has been reached, where a list of items is being scrolled.

SUMMARY OF INTERVIEW

Patent Owner thanks the Examiners for conducting an interview with Patent Owner's counsel and other representatives on January 8, 2013. Patent Owner's statement of the interview is under preparation and will be filed within the time specified in 37 CFR 1.560(b).

SUMMARY OF REJECTIONS

Claims 1-6, 8-12, 16, 19 and 20 stand rejected under 35 U.S.C. § 102(b) over **Lira**. (Rejection A).¹ Claims 7 and 13-15 stand rejected under 35 U.S.C. § 103(a) over **Lira**. (Rejection B).² Claims 1-5, 9-13, and 15-20 stand rejected under 35 U.S.C. § 102(e)³ over **Ordning '975** (Rejection D).⁴

REJECTIONS OVER LIRA

REJECTION A:

Claim Rejections- 35 USC § 102

Claims 1-6, 8-12, 16, 19, and 20 stand rejected under 35 U.S.C. 102(b) as being anticipated by **Lira**.

The following claim mappings in the Request stand incorporated by reference:

¹ Rejection A in the Office Action incorporates by reference the claim mappings set forth in the Request for Reexamination, Exhibit 6, Part A, pages 1-18, 21-24, and 26-30.

² Rejection B in the Office Action incorporates by reference the claim mappings set forth in the Request for Reexamination, Exhibit 6, Part B, pages 1-9.

³ The Office Action, page 2, misstated the statutory grounds of Rejection B as 35 U.S.C. § 102(b). A Miscellaneous Action correcting the error was mailed October 26, 2012.

⁴ Rejection D in the Office Action incorporates by reference the claim mappings set forth in the Request for Reexamination, Exhibit 6, Part D, pages 1-20 and 22-38. There is no Rejection C.

| | |
|---------------------|--|
| Claims <u>1-6</u> | (Request Pages 23-38, Exhibit 6, Part A, Pages 1-18) |
| Claims <u>8-12</u> | (Request Pages 39-41, Exhibit 6, Part A, Pages 21-24) |
| Claim <u>16</u> | (Request Pages 42-43, Exhibit 6, Part A, Page 26) |
| Claims <u>19-20</u> | (Request Pages 26-37, Exhibit 6, Part A, Pages 26-30). |

The rejection is respectfully traversed.

I. Disclosure of Lira

A. Lira's logical columns

Lira has the title "CONTROLLING CONTENT DISPLAY." **Lira** generally addresses the problem of browsing within large "[w]eb pages and other electronic documents," page 1, line 6 (emphasis added); Myers Decl. ¶¶ 53-54, 62-63.

Lira addresses this problem by disclosing a method to reformat the document into a plurality of columns, as long as each column is no wider than the display, see page 1, lines 16-23. Specifically, **Lira** discloses, see **Abstract** (emphases added):

A document served to a device having a small display or display window . . . can be reformatted such that the width of the document is divided into columns, with each column being displayable across the entirety of the small display or display window. In this manner, the width of the small display or display window is used to display less than all of the width of the document. The columns may be based on the content within the document, as long as the column width does not exceed the width of the small display or display window.

Lira consistently describes the creation of these logical columns as mere "reformatting" of the web page. See, e.g., **Lira** page 1, lines 17-19, page 2, lines 1-2, 6-8, 11, page 6, lines 18-19, page 11, line 3, page 21, lines 8, 13-14, page 21, line 20, page 24, lines 1, 8, page 35, line 19, Figure 5. "Reformatting," in turn, is described as just a method "to enhance the readability of the page," page 9, lines 22-23 (emphasis added).

Lira thus discloses an approach to navigating within the displayable edges of a webpage, or other electronic document, on a smaller touch-screen display device, by reformatting the contents of that electronic document into at least two logical columns, each no wider than the display. Myers Decl. ¶ 53.

B. Lira's alignment controls

Another objective disclosed in **Lira** is to keep the display centered on the logical column of content being viewed by the user, see page 2, lines 11-12, page 1, line 27 to page 12, line 2, and page 14, line 18 to page 15, line 7; Myers Decl. ¶ 65.

Lira describes a solution to this problem in the prior art in which the entire content of the page was “reformatted into a single column” no wider than the window, see page 9, lines 21-18. In this embodiment, “[t]he display window stays centered on the column as the user scrolls down the page to read the text,” page 9, lines 27-28 (emphasis added). **Figure 3**'s depiction of this prior art solution lacks a horizontal scroll bar.

Lira also discloses another solution in which “reformatting the electronic document into at least two columns may further include aligning the columns for viewing in the display window,” see page 2, lines 11-12 (emphases added), col. 3, lines 1-5. Thus, when **Lira** divides the content into multiple columns, **Lira** may provide alignment controls to help the user stay aligned with the column of his choice, see, e.g., page 12, line 3 to page 15, line 30.

In one such embodiment, **Lira** discloses a “vertical alignment control” that operates when a user whose display is aligned with one of the columns scrolls the display up or down along that column with a small amount of movement to one or both or either side. The alignment control may constrain side-to-side movement during scrolling, or center the user on that column or another column, see **Lira** page 18, line 18 to page 19, line 31.

One implementation of **Lira**'s vertical alignment control is directed to minimizing horizontal “wobble” when a column is scrolled vertically. This implementation simply ignores horizontal motion (or more precisely, horizontal motion below a certain sensitivity threshold) as the user scrolls up or down the column. However, if the threshold is exceeded to either side, the display will no longer constrain screen scrolling to the vertical direction, see page 14, line 29 to page 15, line 16; Myers Decl. ¶ 62. This vertical alignment control is shown in **Lira Fig. 14A**, a portion of which is shown below.

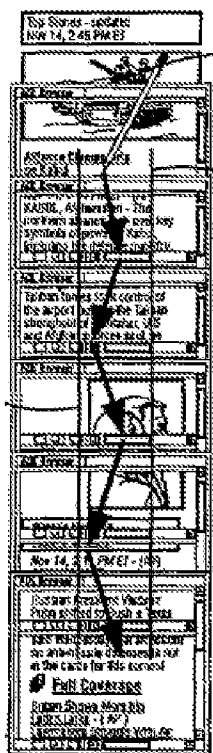

The black, downward-pointing arrows pointing alternately left and right represent the user's scrolling movements that inadvertently wobble slightly from side to side as the user scrolls downward, see **Lira** page 14, lines 20-28. See Myers Decl. ¶¶ 69. Because this implementation of the vertical alignment control operates when the user's pen is on the touchscreen and scrolling is occurring, the horizontal component of the user's movements are constrained to keep the display aligned to the column, see page 14, lines 20 to page 15, line 7. See Myers Decl. ¶¶ 67-68. **Lira** only depicts this "wobble" control functionality in connection with a center column in a web page that has been reformatted into three columns, see **Lira Fig. 14A**.⁵

Lira's Figure 14B depicts a quite different implementation of the vertical alignment control. This implementation operates only when the user lifts pen **1200** from display **1205**. Before the pen lifts, the display is permitted to "wobble" according to the user's inadvertent horizontal wobbling while scrolling, see **Lira** page 15, lines 18-21.

⁵ Note that the Office Action relies not only on the user's side to side "wobbling" during scrolling, but on the user's downward scrolling itself. For example, the Office Action concedes that, if not for the downward scrolling, the Office Action's asserted "fourth portion of the electronic document" would fail to be "different from the first portion" as required, see Request, Exhibit 6, Part A, page 15. Thus, both the scrolling and the wobbling must occur, or the rejection fails even on its own terms.

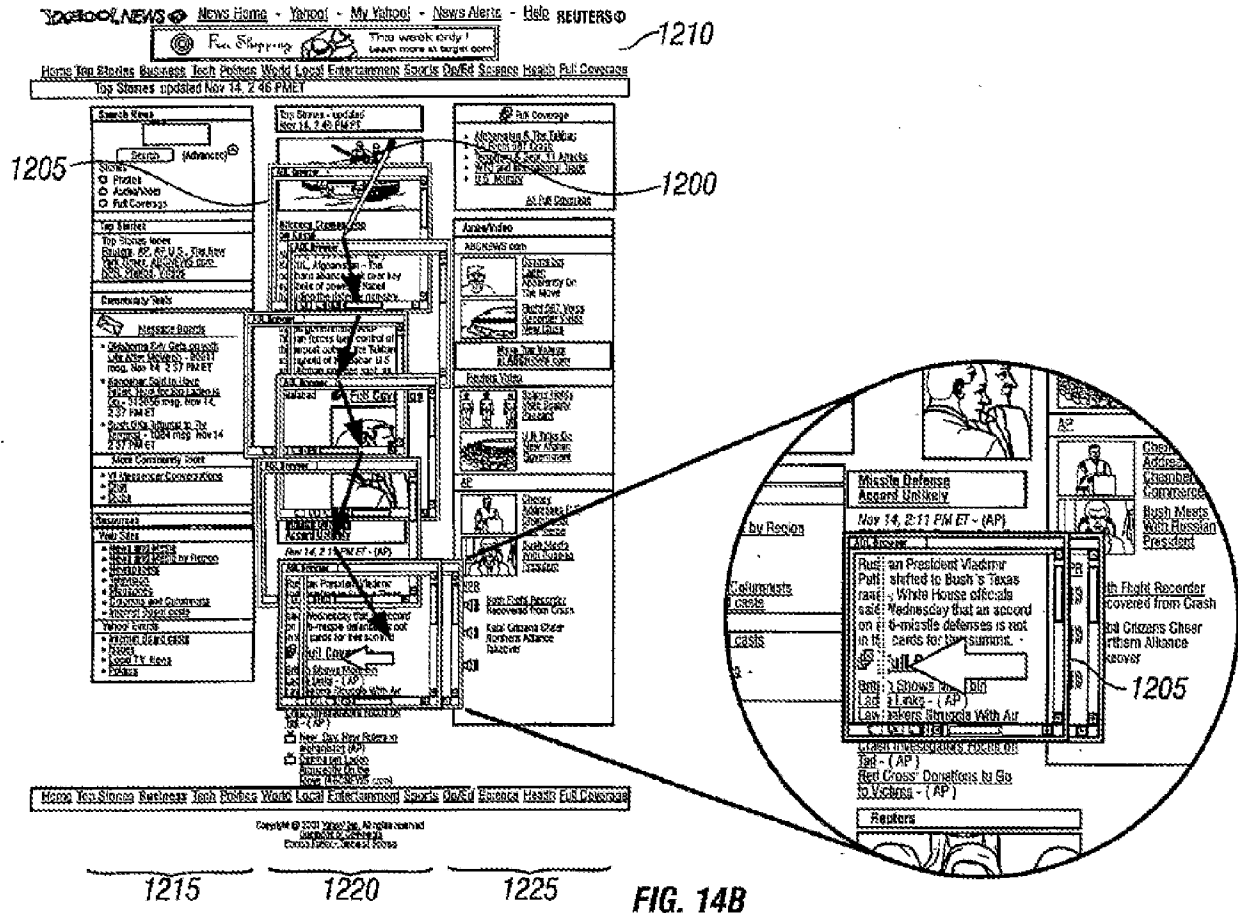

FIG. 14B

In this implementation of **Lira's** vertical alignment control, **Lira** discloses that when the pen lifts off the screen one of several operations may occur. If horizontal wobble has exceeded a "user-defined snap threshold," the display may stay where it is or may be "snapped to the adjacent or repositioned column." If no snap threshold is exceeded, then "the display **1205** centers the logical column **1210** as the pen **1200** is lifted from the screen," **Lira** page 15, lines 18-30. Just like with the **Fig. 14A** implementation, **Lira** only depicts this "wobble" correction functionality in connection with a center column in a web page that has been reformatted into three columns, see **Lira Fig. 14B**. This is consistent with **Lira's** disclosure that movement away from a column is only permitted because a user may intend to move to an "adjacent or repositioned column," page 15, line 25, as well as **Lira's** summary statement that its "[r]eformatting the electronic document into at least two columns may further include aligning the columns for viewing in the display window," page 2, lines 11-12 (emphasis

added). **Lira** does not depict or disclose any permissible movement away from a column in a direction where there is no “adjacent or repositioned column.”

As shown on the left side of **Figure 14B** of **Lira**, the upper black arrows illustrate the user’s inadvertent “wobbling” from side to side while scrolling down the list. The display is shown as wobbling with the pen, indicating that in this implementation, the alignment control does not constrain horizontal portions of the user’s movements while scrolling with the pen on the touch screen, see **Lira** page 15, lines 18-31. See Myers Decl. ¶¶ 70-71.

As Professor Myers explains, these two implementations of the vertical alignment control in **Figs. 14A** and **14B**, as described here, cannot be used for the same column at the same time, for one must operate when the pen is on the screen, and one must operate only after the user’s pen lifts off the display. Myers Decl. ¶ 71.

Lira also mentions a “horizontal alignment control” that “may be used to limit vertical movement when scrolling horizontally,” see **Lira** page 16, lines 1-3. However, **Lira** does not describe how the horizontal alignment control could work when not scrolling horizontally, any more than **Lira** describes how the vertical alignment control could work when not scrolling vertically. The only way **Lira** discloses its “snap to center” functionality on the **Fig. 14B** vertical alignment control is to snap back to the exact center of the column being scrolled, **Lira** page 15, lines 24-25. Hypothetically extending this horizontal alignment control to operate at the bottom of a column would “snap” the user vertically to the vertical center of the column, which would not be a useful result and would align the display away from the content at the bottom of the column the user wanted to see, contrary to **Lira**’s teachings. See Myers Decl. ¶ 75.

Indeed, **Lira** discloses nothing about what would occur if a user reached the top or bottom of one of **Lira**’s columns. As Professor Myers explains, a person of ordinary skill in the art reading **Lira** at the time the ’381 invention was made would expect that, for example, if the user scrolled to the bottom of one of **Lira**’s logical columns, the user would simply continue moving down so the rest of the page below it could be seen. See Myers Decl. ¶ 73.

Nor does **Lira** disclose what would occur if a user attempted to move the display window to the edge of the web page. **Lira** never discloses any displayable area beyond

the edge of the web page, or beyond the edge of any electronic document, and as Professor Myers explains, a person of ordinary skill in the art at the time of the '381 invention would not have expected the AOL browser in **Lira**'s figures or touch screen devices to allow display of areas beyond the web page. See Myers Decl. ¶ 67.

II. **Lira does not anticipate Claim 1.**

A. **Lira does not disclose “an edge of the electronic document being reached”**

The Office Action (incorporating the assertion in the Request, Exhibit 6, Part A, page 10-11) asserts that

in one mode described in **Lira**, if the user moves the screen away from the column being read (thus translating the document), an area beyond the edge of the column will be displayed.

...

. . . As highlighted in [**Lira Fig. 14B**], the display window **1205** is displaying an area beyond the edge of the logical column 1220.

Notably, the Office Action asserts, without expressed support, that each of the columns within a web page, plus the web page itself, are each individually electronic documents, and also cumulatively a single electronic document, see. e.g., Request, Exhibit 6, Part A, page 2 (emphasis added):

As disclosed in **Lira**, the electronic document may be a web page with structured elements such as columns. Each logical column may be further treated as an electronic document as discussed further below, where each logical column (e.g., items 1215, 1220, and 1225 shown in Figure 14) are subdocuments in a larger electronic document: the web page.

See also, e.g., id. pages 5-8, 11-12.

Here, the Office Action asserts that the right “edge” of column **1220** in **Lira Fig. 14B** is “an edge of the electronic document . . . reached.” This assertion is respectfully traversed.

First, as explained in detail below, **Lira** does not disclose column **1220** in **Lira Fig. 14B** to be “the electronic document.” Therefore, no edge of column **1220** can be “an edge of the electronic document.”

Second, as explained in detail below, even if column **1220** could be “the electronic document,” no “edge” of the column can “be[] reached” under **Fig. 14B**’s snap-to-center vertical alignment control mode.

1. Lira does not disclose its column to be “the electronic document”

Interpreting **Lira**’s logical columns as “electronic documents” would contradict **Lira**’s disclosure.

As noted above, the purpose of **Lira** is to address viewing and navigation of “[w]eb pages and other electronic documents” on a display window that can “display less than all of the width of the document,” see **Lira** page 1, lines 20-21. The prior art permitted electronic documents that had only one column, the column having a width wider than the display, see **Lira** at col. 9, lines 12-28. **Lira** disclosed an approach to navigating within the displayable edges of a webpage or other “electronic document” on a smaller touch-screen display device, by reformatting the contents of that electronic document to divide the width of one electronic document wider than the display into a plurality of columns that are each no wider than the display (page 2, lines 1-3; see page 1, lines 16-20; Myers Decl. ¶ 47).

Lira uses the term “electronic document” over 50 times, but not to refer to logical columns. Instead, **Lira** consistently uses “electronic document” to refer to the entire page of information that is reformatted into logical columns. E.g., **Lira**, Abstract, page 2, lines 1-3, 5-6, 11-12, 19-21, page 21, lines 5, 8-9, 11-14, 19-20, page 22, lines 22, 24, 27-28, page 23, lines 1-2, 3-5, 9, 11-12, 18, 24-25, page 24, lines 1-2, 7. See Myers Decl. ¶ 56.

Judge Koh of the Northern District of California, whose claim construction order regarding the **’381** patent was consulted in the Office Action at 3, issued an order on December 2, 2011 finding that there was no reasonable likelihood that the **’381** patent could be found invalid over **Lira**, and found that **Lira**

generally addresses the problem of browsing large documents – such as a web page For example, the patent discloses a method to reconfigure the document into multiple columns . . .” (*Apple, Inc. v. Samsung, Inc.*, 11-cv-1846, 2011 WL 7036077, at *34 (N.D. Cal. Dec. 2, 2011)) (emphases added)

It is unsurprising that **Lira**'s electronic documents and logical columns should be consistently treated as two different things. **Lira**'s columns are, by definition, a subset of an electronic document. In fact, for a given small display, the electronic document in **Lira** is always wider than the display (page 1, lines 16-21), whereas the logical column in **Lira** is always no wider than the display (page 2, lines 1-3; page 11, lines 10-11).

Further analysis of **Lira**'s disclosure to determine whether **Lira**'s columns are viewable as independent electronic documents finds extensive confirmation that **Lira**'s columns are not reasonably interpreted as electronic documents.

An example of **Lira**'s reformatting of a document to divide its width into a plurality of logical columns no wider than the display window is shown in **Figs. 4A** and **4B**.

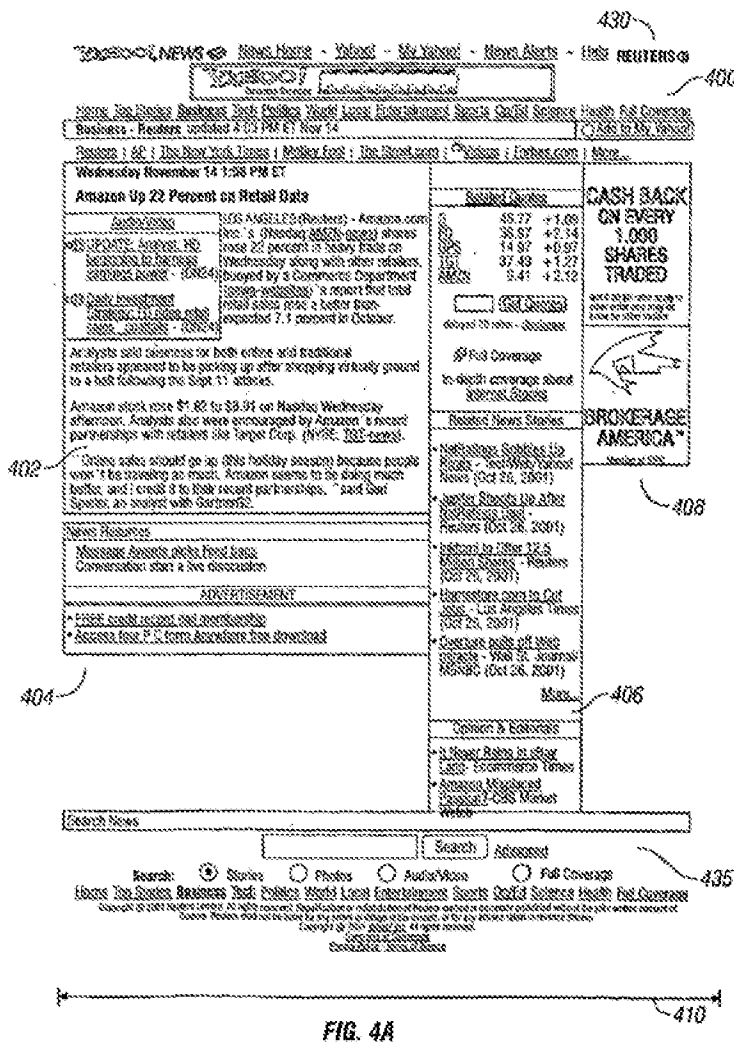

FIG. 4A

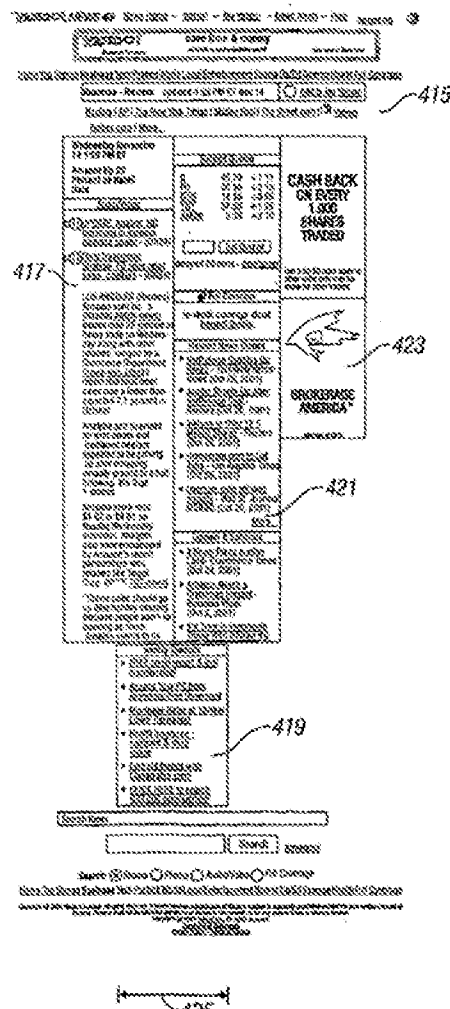

FIG. 4B

In this example a web page, page **400**, is formatted for display on a large display with wide window width **410**. Thus, **Lira** reformats page **400** to divide the width of page **400** into columns no wider than a narrow display such a PDA display width **425**, see page 9, line 29 to page 10, line 9 (emphases added):

Figs. 4A and 4B show that a page 400 (Fig. 4A) having elements 402, 404, 406 and 408 of differing widths and sized to fit a wide window width 410 may be reformatted as a page 415 (Fig. 4B) having elements 417,419,421 and 423 with widths corresponding to the width 425 of a narrow display (e.g., a PDA display). The elements 417, 419, 421 and 423 are readable columns of information that each fit within the width 425 of the display window or can be reduced to a width that does not exceed the width of the display window 425. The elements 417, 419, 421 and 423 are aligned to correspond with the topology of the page 400. Thus, even though the page 415 exceeds the viewing boundaries of the display window, the user can view various portions of the page 415 with a better sense of the orientation of the content on the page 415 and can navigate on the page 415 more easily.

Importantly, **Lira** discloses that its columns, including in particular column **1220** and the other columns in **Fig. 14B**, are reformatted portions of the content of an electronic document, and **Lira**'s columns are always created by "reformatting" the content of an existing web page or other electronic document. Decl. of Myers ¶¶ 60-62. The columns are not independent of the web page, and there is no indication that they have any independent existence or meaning other than as a means of conveniently arranging a subset of the web page's content. Furthermore, the portion of **Lira** just quoted above clearly states that the content viewable in each reformatted column remains the content of web page 415, and is not now the content of the column instead. There is no indication in these disclosures that, when the electronic document in **Lira** is reformatted into a page having logical columns, the result would be more than one document. Myers Decl. ¶¶ 62, 89. To the contrary, Professor Myers explains that **Lira** works in the following way (Myers Decl. ¶¶ 61):

In **Lira**, reformatting a web page into three columns does not generate three separate or embedded "electronic documents," any more than reformatting a business letter in a word processing program to have three columns creates three separate or embedded electronic documents. If **Lira** had intended such an unusual meaning, one would have expected **Lira** to have at least once referred to the columns, or anything else, of the web page as being "documents" themselves – and to have described the

creation of the logical columns in terms of removing or at least changing the contents of the original web page, instead of simply “reformatting the electronic document,” see **Lira** at page 2, lines 5 to 8 (emphasis added). In particular, a person of ordinary skill in the art at the time of the invention would have understood Lira’s disclosure to mean the reformatted columns remain part of the single electronic document and do not become “embedded” documents or “sub”-documents.

There is no indication that this reformatting of “page **400** . . . as page **415**” in **Lira** increases or even changes the number of electronic documents involved in the “page,” see page 9, line 29 to page 30, line 2. Instead, it is clear that **Lira**’s reformatting of the web page into columns does not divide the content of a single electronic document into different electronic documents. According to **Lira**, both before and after reformatting a document into logical columns, all of the columns (1) continue to all be “elements” that a single page still “has”; (2) continue to all be “on the page”; and (3) continue to all have content that remains “the content of the page.” Myers Decl. ¶¶ 57-61, 89.

Nor does **Lira** disclose that its reformatting ever creates, or leaves, any space, gap or separation between logical columns. **Lira**’s statement that “the width of the document is divided into columns,” **Lira** page 1, lines 16-20, indicates that no such gaps between the columns exist. Consistent with this dictum on page 1 of **Lira**, most drawings in **Lira** show no such separation between columns, such as **Fig. 8A-8C, 13** and **14A-14B**. A few, including **Figs. 13, 14A** and **14B**, seem to add blank areas in the wide view, but each of these figures has a close-up view, and that view shows no such separation or blank gap.

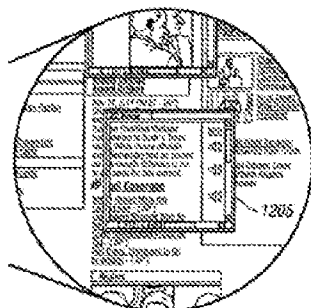
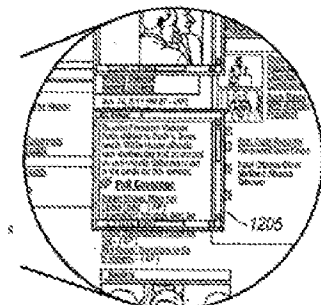
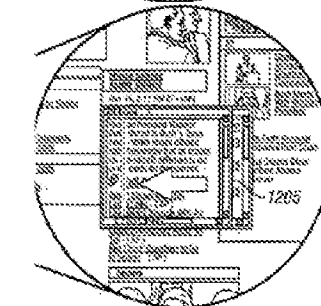
Fig. 13
Exploded
ViewFig. 14A
Exploded
ViewFig. 14B
Exploded
View

Indeed, the Office Action relies upon the fact that there are no gaps between the columns to support **Rejection B**. The Office Action asserts that **Lira's Fig. 14B** "snap"-to-center vertical alignment control implementation – on which all the rejections on **Lira** in the Office Action are based – renders Issued Claim 13 invalid for obviousness under 35 U.S.C. § 103, see OA 5, Request, Exhibit 6, Part A, pages 6-7. Claim 13 depends from Claim 1 and adds the requirement that "the area beyond the edge of the document is black, gray, a solid color, or white."

The Office Action bases its argument that Claim 13 is invalid on the following reasoning:

- (i) Column **1220** is "the electronic document";
- (ii) The right boundary of column **1220** is the "edge of the electronic document being reached"; and
- (iii) It is obvious for the area beyond the "edge" of column **1220** to be black, gray, a solid color, or white because

“in Figure 14B, if the background of the web page is a solid color (e.g., white), that will be the color of the area beyond the edge of the document, given that the area beyond the edge [of column 1220] will be a portion of the neighboring column 1225. Thus, under this example, the area beyond the edge of the column displayed is a solid color, e.g., white.”

This is true even though, in **Lira Fig. 14B** itself, there falsely appear (aside from the close-up view) to be gaps shown between the columns. Indeed, **Fig. 14B** is reproduced in the Office Action immediately after the statement above.

Accordingly, as the Office Action notes, **Lira**'s columns have no area between them that is not part of one of the columns.

Furthermore, there is no reason to believe that “reformatting” would divide an existing document into multiple documents. **Lira** states that “[r]eformatting a page requires identification of the page topology from the page format coding,” and cites HTML as a common page topology that is usually “readily reformatted into constrained sets of logical columns,” see **Lira** page 10, lines 12 to 30. HTML does distinguish among the topology of headers, footers, the body of the text, etc., see page 10, lines 13-20. However, the entire page with header, footer and body in HTML is still a single document, see Myers Decl. ¶¶ 55-57.

Lira states that “the page may be recoded in a language other than HTML for easier viewing on the small display window,” see **Lira** page 11, lines 8-9. However, this would be taken by a person of ordinary skill in the art to merely refer to HTML-like encoding for the small devices of the time, such as WML for WAP devices – a change that does not suggest that the “recoded” page would become multiple “electronic documents” any more than they would in HTML. Myers Decl. ¶ 62.

In one embodiment, **Lira** states that the page layout may be detected for purposes of reformatting by separating the layout of the page into components and then analyzing those components, see page 11, lines 7 (emphasis added). The example given of this, however, is merely the “header, body, or table tags” in coding of an HTML page. Such a page, as already noted above, would be a single document.

In sum, **Lira** does not disclose columns that are electronic documents.

2. Interpreting the boundary of Lira's column as an "edge" of "the electronic document" would contradict the '381 specification

Interpreting "electronic document" in the '381 claims to read on **Lira's** logical column **1220** would also conflict with the specification of the '381 patent.

a. Lira's column is not an "electronic document" under the '381 patent.

The '381 patent and **Lira** both use the term "electronic document" in similar ways. Like **Lira**, the '381 patent applies the term to web pages. Also like **Lira**, the '381 patent does not regard small formatted subareas in web pages as electronic documents. For example, as explained in detail in the section devoted to the '381 specification above, method **700** of the '381 patent, which "provides a simple visual indicator to a user that one or more edges of an electronic document are being displayed," operates on the edges of the webpage, but ignores when the boundaries of internal items on the web page such as the "blocks **3914** of text content and other graphics (e.g., images)" depicted in **Figs. 8A-8D** are reached, see col. 26, lines 65-67, col. 27, lines 25-39, 53, 65, col. 28, line 2, 35-36, col. 28, line 48 through col. 29, lines 18, col. 29, lines 54-55, col. 30, lines 9-10, Myers Decl. ¶¶ 46, 50-51.

Given that the '381 patent's method **700** treated the boundary of internal Block **9** as if it were not an "edge of the electronic document," the '381 patent lends no support for treating **Lira's** internal reformatted column of information **1220** as an "electronic document" either.

Finally, because internal edges are not responded to for purposes of the invention, **Lira's** column cannot be an "electronic document" as claimed, because it is embedded in what no one disputes is an electronic document, namely web page **1210**. The term "edge of the electronic document" is used continuously and exclusively in the related sections of the '381 specification to refer to edges of, for example, webpage electronic document **3912**, see, e.g., '381 patent, col. 26, line 66. The '381 specification is fully consistent with the use of the term "edge of the electronic document" to mean what might be called the "outer" edges of the webpage, rather than internal edges.

Moreover, this “edge” is the edge detected in process **700** by step **710** to determine when it is necessary to change process operations. The resultant change is to move along the “Yes” branch to steps **714** to display the “fill” area and to step **720** to await lift off to move the edge of web page **3912** back to the edge of the display where it was first detected.

As noted above, however, step **710** does not make a “Yes” determination when the boundaries of internal blocks on the webpage are reached.

Accordingly, **Lira’s** column **1220** cannot be an “electronic document” consistent with the specification of the **'381** patent.

b. Lira’s column boundary is not an “edge of the electronic document” by virtue of being internal to the web page.

Because **Lira’s** column is not an “electronic document,” it cannot have “edges of the electronic document.” Patent Owner, however, has reviewed the following statements from the Office Action (p.3 (emphasis added)):

With respect to the following rejections over Lira, the "edge of the electronic document" has been shown to be capable of being construed as an internal edge, as opposed to being limited to the outer edge of a document as a whole. The Courts agree with the Examiner's independently formulated interpretation, as can be seen in the April 4, 2012 Order Construing Disputed Claim Terms of the '381 Patent issued by the Federal District Court for the Northern District of California in Apple Inc. v. Samsung Elecs. Co., 5:11-CV-01846-LHK, ECF No. 849 (Exhibit 7), where it was decided that "an electronic document can be embedded in another electronic document, and there for the "edge of an electronic document" is not limited to "external" edges." Under Lira, whole documents (webpages) further contain individual images and column based text portions (see page 11, line 27 through column 12, line 2 and in figure SA), that are internal to the webpage as a whole, where bounce back is effected responsive to the window being misaligned with the column based sub-document content (see page 15, lines 18-31). Furthermore, under Lira, the column in which the display window is located over could be an outside column where when the window is moved away from the document and over an outside boundary, the bounce back could be responsive to the document as a whole, moving from the whitespace on the top, bottom, and sides of the web page back over the webpage.

Patent Owner does not fully understand the Examiner’s statement set forth above. However, to the extent it is understood, it does not mean that Lira’s columns are, or even can be, electronic documents. Moreover, even if it did, Patent Owner respectfully disagrees with the understood interpretation. In order to further the

prosecution of this reexamination without unneeded delay, Patent Owner has responded to the specific anticipation rejections as best understood from the examiner's statements and accompanying papers.

i. The Office's interpretation of "edge of the electronic document" is unclear

Based on a careful review of the Office's comments set forth above, and relevant documents including the Order cited, Patent Owner understands that the Office's interpretation of "edge of the electronic document" is not limited to "'external' edges" in that "edge of the electronic document" may include "internal edges," where "internal edges" refers to external edges of a first electronic document that is embedded inside a second electronic document, so that the edges are "internal" to the second electronic document but not the first electronic document.

To clarify, in the April 4, 2012 Order Construing Disputed Claim Terms of the '381 Patent issued by the Federal District Court for the Northern District of California in *Apple Inc. v. Samsung Elecs. Co.*, 5:11-CV-01846-LHK, ECF No. 849 (Exhibit 7 to Request), the claim construction dispute regarding the '381 patent centered on whether an "electronic document" (in the claim language "edge of the electronic document") could or could not "be embedded inside another electronic document." As noted by the Examiner, "it was decided that 'an electronic document can be embedded in another electronic document' and there[for]e the 'edge of an electronic document' is not limited to 'external' edges." Order Construing, Request Exhibit 7, at 21 (emphases added).

Based on the Court's and Office's stated reasoning, it is Patent Owner's understanding that under the Office's interpretation, if electronic document A has edges ABCD, and has embedded within it a second electronic document Z having edges WXYZ as well as a hand-drawn rectangle R having edges OPQR, as illustrated below, then, for purposes of this claim limitation:

- The "edges" of electronic document A are ABCD, but not OPQR or WXYZ.
- The "edges" of electronic document Z are WXYZ, but not ABCD or OPQR.
- R is not an electronic document and has no "edges of an electronic document".

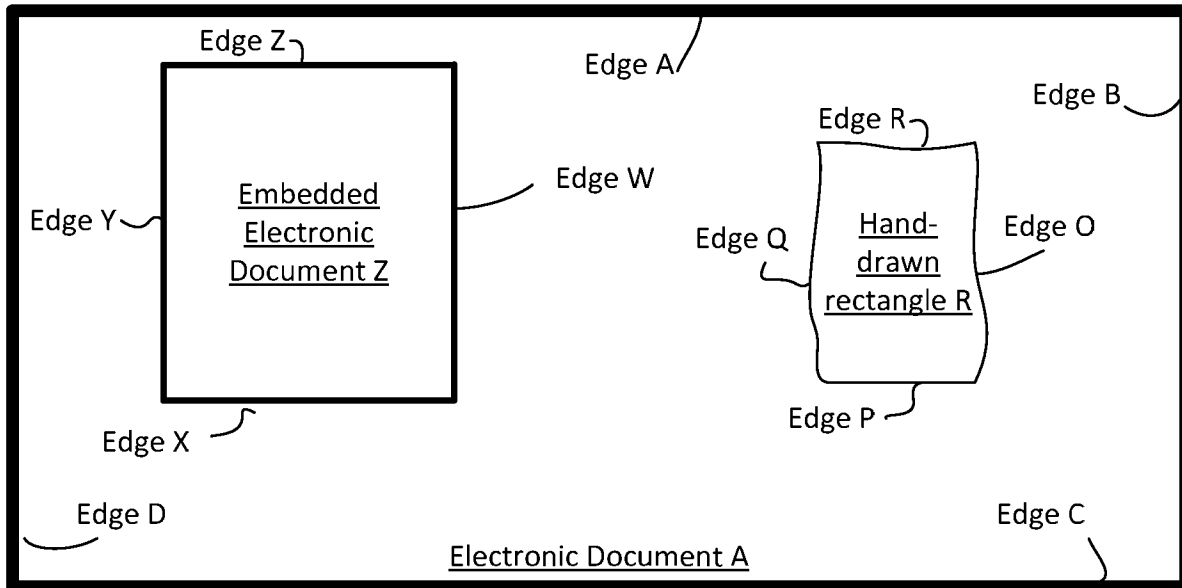

To the extent that the Office's position is different from that set forth above, the Examiner is respectfully requested to withdraw the rejections and issue an Office Action clearly stating and applying the Office's interpretation.

ii. Under the Office's understood interpretation, Lira's column boundary is not an "edge of the electronic document"

Even if the Office's interpretation (as understood below) is correct, it is entirely consistent with both the Office's interpretation and the court's Claim Construction Order for Lira's columns to *not* be the electronic document. The Order construes "edge" to include internal edges. By this, as explained above, this means that "edges of the electronic document" include not just the edges of documents that are not embedded in another document, but the edges of electronic documents that are embedded in another document. The Order does not rule that "internal edges" include any and every internal boundary, or every arbitrary boundary drawn within the document by the Requester. In other words, the edges of an internal embedded electronic document are "internal edges," but a simple line drawn somewhere on the web page is not an "internal edge" under the court's construction.

iii. The Office relies on a flawed interpretation of “edge of the electronic document”

To the extent that the Office’s interpretation of “edge of the electronic document,” as explained above, is understood, Patent Owner respectfully disagrees with the Office’s interpretation, and also respectfully continues to disagree with the court’s interpretation. Patent Owner continues to adhere to the view that the interpretation that it advocated before the court was correct. On its face, the claim construction order referenced above is flawed by the fact that the court rewrote key claim language on the way to its erroneous construction that “[a]n ‘edge’ of an electronic document may be internal,” Request Exhibit 7, page 23.

The order misidentified the term for construction as “edge of [an or the] electronic document.” See Request, Exhibit 17, page 17. However, the phrase “edge of **an** electronic document” appears nowhere in the claims, or indeed in the patent. The proper phrase for construction is “edge of **the** electronic document,” limited to the definite article “the,” as reflected in the claims. If the indefinite article “an” were not erroneously substituted for “the” in this analysis, the court would not likely have concluded, in light of the disclosure, that an edge of “the” singular electronic document may be internal.

As Professor Myers notes in his declaration, the phrase “electronic file” in the ‘381 specification refers to a digital file which contains display data for the display of an “electronic document having a document length and a document width,” Myers Decl. ¶¶ 21-22; see ‘381 patent, col. 2, lines 14-19. To a person of ordinary skill in the art, such electronic documents as described in the ‘381 specification would not “contain data for the display of areas beyond the edges of the electronic document of a particular height and width.” Myers Decl. ¶ 22. Accordingly, the assertion that an edge of “the” electronic document could be internal, and therefore that the electronic document could include within itself areas beyond internal edges, runs contrary to the understanding of one skilled in the art.

Moreover, because “the” electronic document on which Process 700 is performed would not include data for the display of areas beyond its edges, it is irrelevant whether there may be embedded documents with internal edges present in

“the” electronic document. Those internal edges would not be edges of “the” electronic document, any more than the edges of a photograph on the New York Times web page would be considered the edges of the New York Times web page. Indeed, as discussed above, the ‘**381** patent specifically contemplates an electronic document, such as a web page, with internal “blocks **3914** of text content and other graphics (e.g., images),” see col. 28, line 48 through col. 29, lines 18, Myers Decl. ¶ 50. The “edge of the electronic document” in the claim language refers not to any “internal edges” surrounding those blocks of content or images, but rather to the edges of the electronic document on which Process **700** is performed. Therefore, it is respectfully submitted that neither the court’s nor the Examiner’s construction including internal edges is supported by either the specification or the language of the claims. Patent Owner reserves its rights to appeal the determination of this issue, and notes that it believes the court case in question has not become final for purposes of appeal.

3. Even if Lira’s column boundary were “an edge of the electronic document,” it is not “reached while translating the electronic document in the first direction” under Lira’s vertical alignment control mode

Even if the boundary of **Lira’s** column **1220** were an “edge of the electronic document,” it is not “being reached while translating the electronic document in the first direction,” because it is already displayed.

The Office Action incorporates the Request’s contention that **Lira** discloses reaching an edge of the column by the user moving the screen away from the center of the column, see Request, Exhibit 6, Part A, page 10, shown above and repeated below:

in one mode described in *Lira*, if the user moves the screen away from the column being read (thus translating the document), an area beyond the edge of the column will be displayed.

The “one mode” mentioned in the Request is **Lira’s** vertical alignment control in its “snap”-to-center implementation, see **Lira Fig. 14B**, which is the only mode disclosed in **Lira** that the Office Action asserts anticipates the claims, see, e.g., Request, Exhibit 6, Part A, page 11 (figure from Request attached).

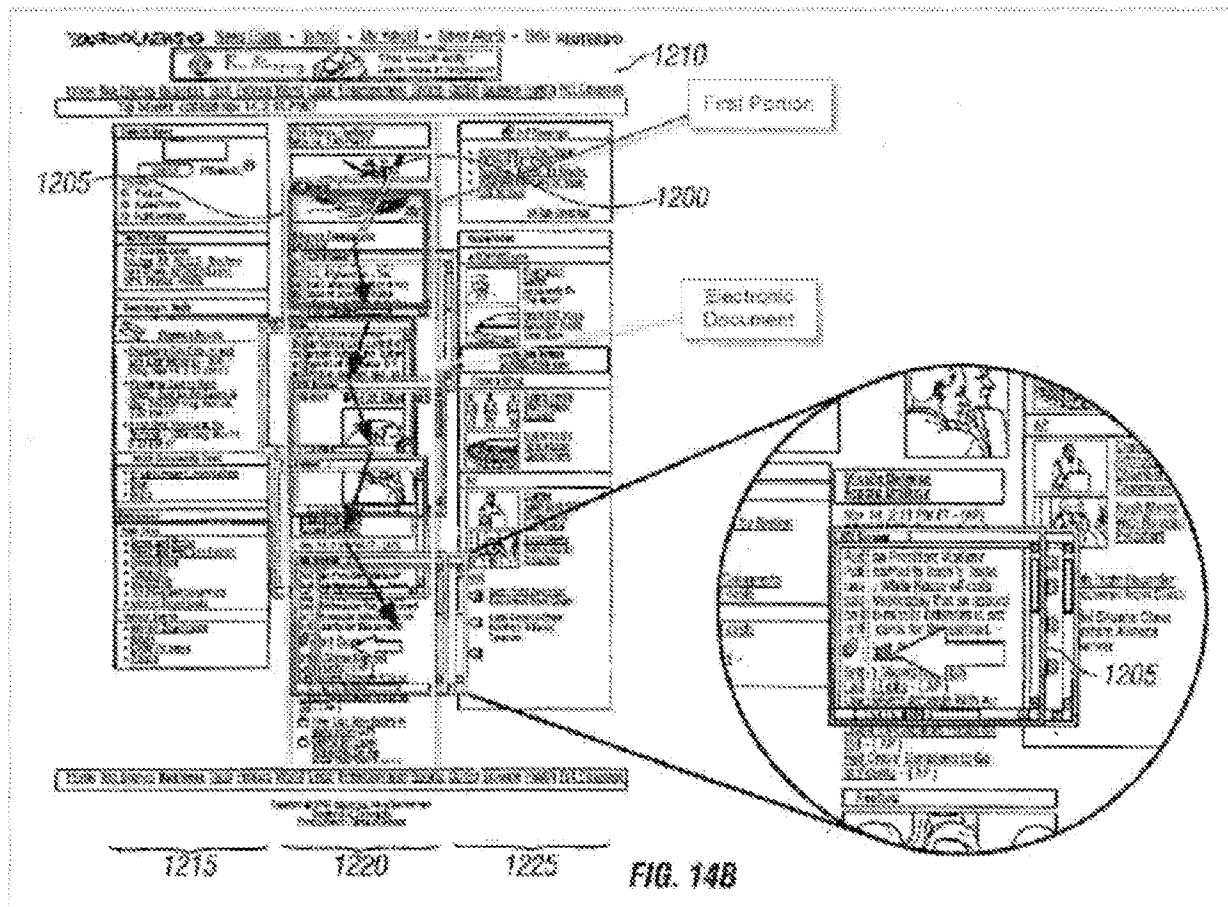

However, in **Lira's** “snap’-to-center” implementation relied upon in the rejection, it is impossible to reach the boundary of the column while translating in the first direction.

Lira's “snap”-to-center implementation operates to allow the user to use the pen to scroll the display window down the column being read (or, said another way, to scroll the column up the display window), and then, when the user lifts the pen, re-center the column in the display, see **Lira** page 15, lines 18-25. As the Office acknowledges, **Lira** requires numerous “conditions that trigger this ‘snap’ behavior,” Request, Exhibit 6, Part A, Line 11. One is that the display is aligned with column **1220** when the user begins scrolling down the column. Indeed, the Office Action plainly shows that the display is aligned with the column at the start of translation in the vertical alignment mode, see Request, Exhibit 6, Part A, pages 6-7.

However, **Lira** discloses that the width of each of its logical columns must not exceed the width of the display, see **Lira, Abstract**; page 1, lines 21-24; page 2, lines 1-3; page 10, lines 4-5. As a result, the entire width of column **1220** must be within display window **1205** when it is centered on column **1220**, e.g., as shown in **Fig. 14B** immediately above the location labeled as the asserted “1st position”. Therefore, although the right boundary of column **1220** is not identified in **Lira**, any right boundary of column **1220** must already be within the display window when translation in the asserted first direction begins.

As a result, the subsequent inadvertent rightward “wobble” in translation of webpage **1210** causes the right boundary of column **1220** to stay within display window **1205**, not to “reach” display window **1205**. In particular, the asserted “edge . . . being reached” of column **1220** is merely moving further to the left within display window **1205** while translating in the asserted first direction.

Nor can it be maintained that any modification to the assumed “wobbling” back and forth in **Lira** by the user in the course of scrolling down the column would cause this element of the claim to be met. **Lira**’s “snap”-to-center vertical alignment control mode, which is the only mode relied upon in the Office Action for the rejection, is disclosed for correcting inadvertent leftward and rightward wobble in the course of scrolling up or down the column, see **Lira** page 14, line 18 to page 15, line 31. Any modification of **Lira**’s disclosure of the “snap”-to-center vertical alignment control based on different inadvertent leftward or rightward movements by the pen would rely upon a “correct” sequence of assertedly anticipatory events to occur only by sheer chance. Nor can this problem be sidestepped by attempted reliance on an intentional leftward or rightward movement to anticipate the ’**381** claim 1. **Lira** is expressly disclosed to be programmed so that any leftward or rightward translation interpreted as intentional does not snap the display back to the starting column, but instead either does nothing, or moves the display further in that direction to another column, see **Lira** page 15, lines 18-29. Thus, the only situation in which an intentional translation toward the asserted “edge” would operate to snap the display back to the column upon liftoff would be if the user had failed to correctly set the sensitivity thresholds that **Lira** uses to interpret such movements as intentional or not. Again, assuming a sequence of events in **Lira** in an

attempt to map Lira to claim 1 would require either assuming events that are neither guaranteed nor disclosed or else directly contradicting Lira's disclosure.

Anticipation must be based on clear disclosure of all the elements of the claim, not on hindsight assertions that the claim might have been practiced had undisclosed and unguaranteed events happened to occur. "The fact that a certain result or characteristic may occur or be present in the prior art is not sufficient to establish the inherency of that result or characteristic." **M.P.E.P. § 2112(IV)** (emphasis added) (citing *In re Rijckaert*, 9 F.3d 1531, 1534, 28 USPQ2d 1955, 1957 (Fed. Cir. 1993) (reversing rejection because inherency was based on what would result due to optimization of conditions, not what was necessarily present in prior art); *In re Oelrich*, 666 F.2d 578, 581-82, 212 USPQ 323, 326 (CCPA 1981). "The mere fact that a certain thing may result from a given set of circumstances is not sufficient." *Id.* (emphasis added) (quoting *In re Robertson*, 169 F.3d 743, 745, 49 USPQ2d 1949, 1950-51 (Fed. Cir. 1999).

Accordingly, even if the boundary of column **1220** were an "edge of the electronic document," it is not "being reached while translating the electronic document in the first direction," but merely being moved to a different position in the display.

B. Lira does not disclose "displaying an area beyond the edge of the electronic document"

The Office Action asserts that **Lira** discloses that an "area beyond the edge of the document" is displayed if the user translates the document away from the column being viewed on the ground that, if **Lira's** user moves the screen away from the column being read, "an area beyond the edge of the column" will be displayed, see for example Exhibit A, part 6, at the bottom of page 10 and at the top of page 12.

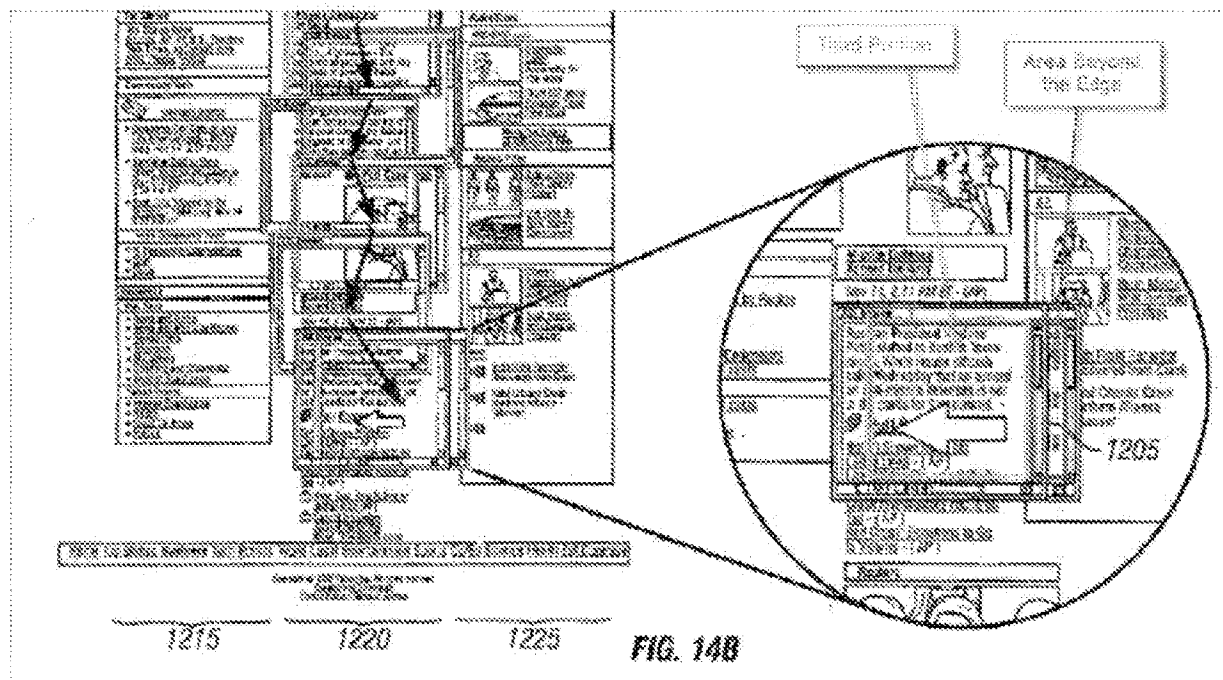

However, as noted above, **Lira** does not disclose that **Lira**'s logical column is an "electronic document." It is merely a formatted column of content of webpage electronic document **1210**.

In Requester's annotated copy of **Fig. 14B**, presented immediately above, the portion displayed in display window **1205** labeled "asserted area beyond the edge" is simply another portion of webpage electronic document **1210** beyond an asserted (and unidentified and undiscussed by **Lira**) boundary of column **1220**. Since the column is not "the electronic document," this is not an area beyond the edge of it.

(To the extent, if any, it is argued that this area is "beyond" an "internal edge" of webpage electronic document **1210**, that interpretation cannot be sustained, for if the area of the electronic document extended to both sides of this asserted line, it would not be an "edge of the electronic document." An "edge of" a document indicates a divide between where the document is and where it is not.)

Therefore, nothing in **Lira** anticipates "displaying *an area beyond the edge of the document*" as claimed in claim 1.

C. Even if Lira discloses “displaying an area beyond the edge of the electronic document,” it does not display “in response to [the] edge . . . being reached”

Even assuming that the area to the right of the asserted right boundary of column **1220** is an “area beyond the edge of the electronic document,” it is not displayed “in response to” that asserted edge being reached.

The Office Action asserts that **Lira** discloses displaying this area and portion “in response to an edge of the electronic document being reached” by disclosing that, upon translation, an area beyond the edge of the column will be displayed, see Ex. 6, Part A, pages 10 to 13:

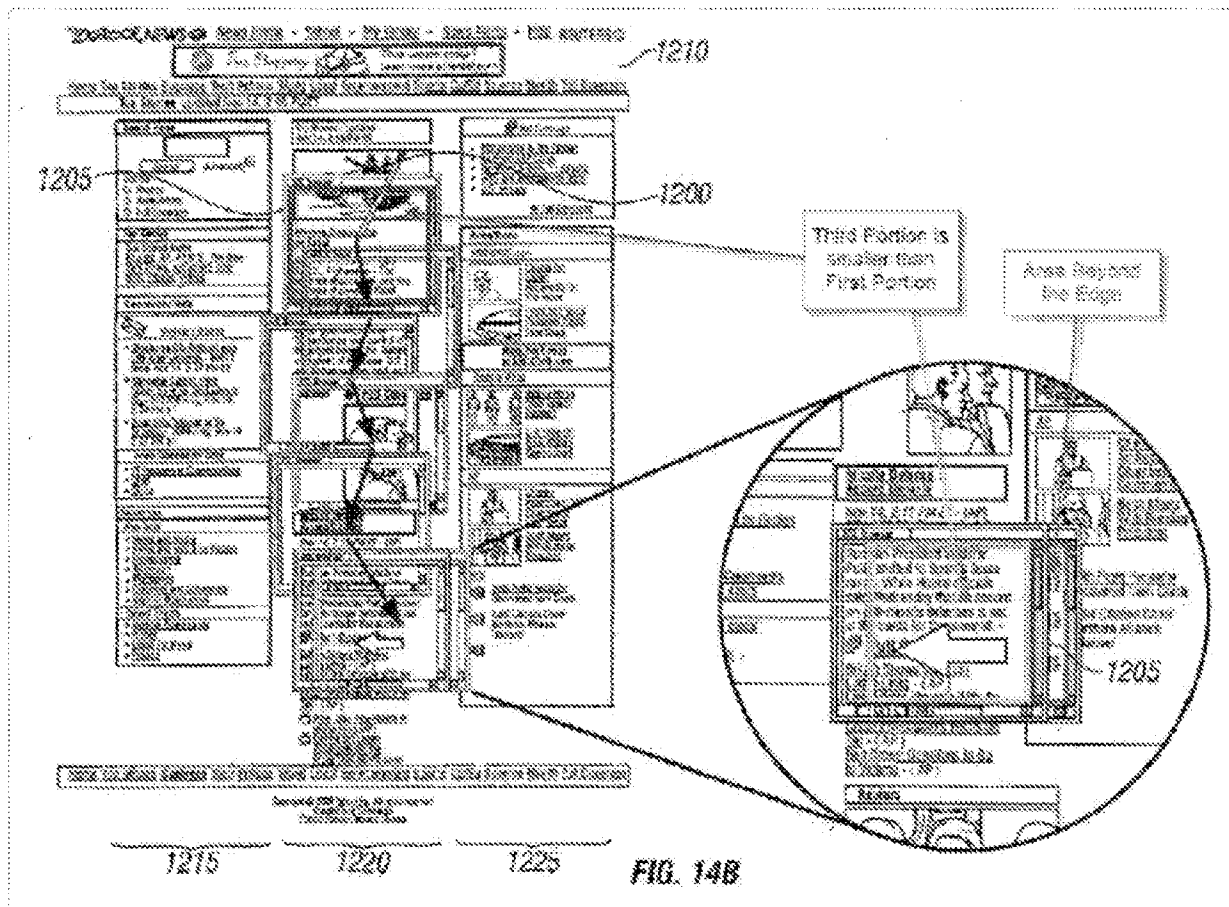

However, the asserted “area beyond the edge” is simply the contiguous area adjacent to the previously displayed portion of the asserted “electronic document,” (column **1220**), and which will be displayed by translation in that direction without any regard to whether or not an edge of a column is reached. There is no disclosure that **Lira** modifies its behavior in any way depending upon whether this boundary reaches

the screen, or even makes any special note of it reaching the screen. Moreover, even if **Lira** contained a teaching of displaying anything in response to reaching an edge of a column, as explained above, the right edge of column **1120** was already displayed at the start of the scrolling down of column **1220**. Therefore, the asserted “edge” of the column was already displayed, and this area is not displayed in response to it being reached.

Therefore, **Lira** merely discloses that this area is displayed in response to translation, not in response to an “edge” being reached.

D. Lira does not disclose “displaying a third portion of the electronic document . . . while translating in the first direction”

The Office Action further asserts that **Lira** discloses that an area beyond the edge of the column is displayed if the user translates the document away from the column being viewed, see for example Exhibit A, part 6, at the bottom of page 10 and at the top of page 12, as follows (emphasis added):

in one mode described in *Lira*, if the user moves the screen away from the column being read (thus translating the document), an area beyond the edge of the column will be displayed.

. . . .

This same behavior is part of the continuation of the act of scrolling down the page described in the previous two steps. As the user continues to scroll the display window (at an angle to true vertical) down over the column and reaching an edge of the document, an area beyond the edge of the document is displayed.

However, Claim 1 does not require that the area beyond the edge be displayed during a “continuation of the act of scrolling down the page,” or even that it be displayed while the user “continues to scroll the display window [] at an angle to true vertical down over the column.” The claim requires that the area beyond the edge of the document be displayed “*while translating the electronic document in the first direction.*” The scrolling described in the Office Action is not displaying this portion while translating the electronic document “*in the first direction.*”

In particular, as shown in the various copies of **Fig. 14B** annotated by the requester in Exhibit 6, Part A, there are clearly several intermediate translations between the translation in the first direction from the asserted first portion to the

asserted second portion and the subsequent later translation in a different direction to the asserted third portion, so that the display of the asserted third portion and the area beyond the edge do not occur while translating in the first direction (*i.e.*, from the first to the second portion).

In particular, at page 7 of the Request, Exhibit 6, Part A, the annotated portion of the full copy of **Fig. 14B** labels the asserted “first portion”. At page 10 of the Request, Exhibit 6, Part A, the annotated portion of another full copy of **Fig. 14B** labels the asserted “second portion” and a first arrow is asserted to represent the first direction of translation between the display of the first and second portions. At page 11 of the Request, Exhibit 6, Part A, a portion of **Fig. 14B** labels the asserted “third portion” in the expanded balloon shown to the right of the showing of column **1220**. (Note that the asserted “third portion” in the showing of column **1220** is not labeled and column **1220** has been truncated so that the arrow representing translation in the first direction from the first to the second portion is not clearly shown.)

A full copy of **Fig. 14B** is provided below, which has been annotated by the undersigned to show the asserted labeling of the first, second and third portions (in both the showing of column **1220** as well as in the expanded balloon) and the asserted area beyond the edge in accordance with the annotations made (by the requester) in the copies of **Fig. 14B** on pages 7, 10 and 11. Further, the first asserted “first direction” of translation between the first and second portions, and the second asserted “first direction” of translation to the third portion, have also been labeled by the undersigned.

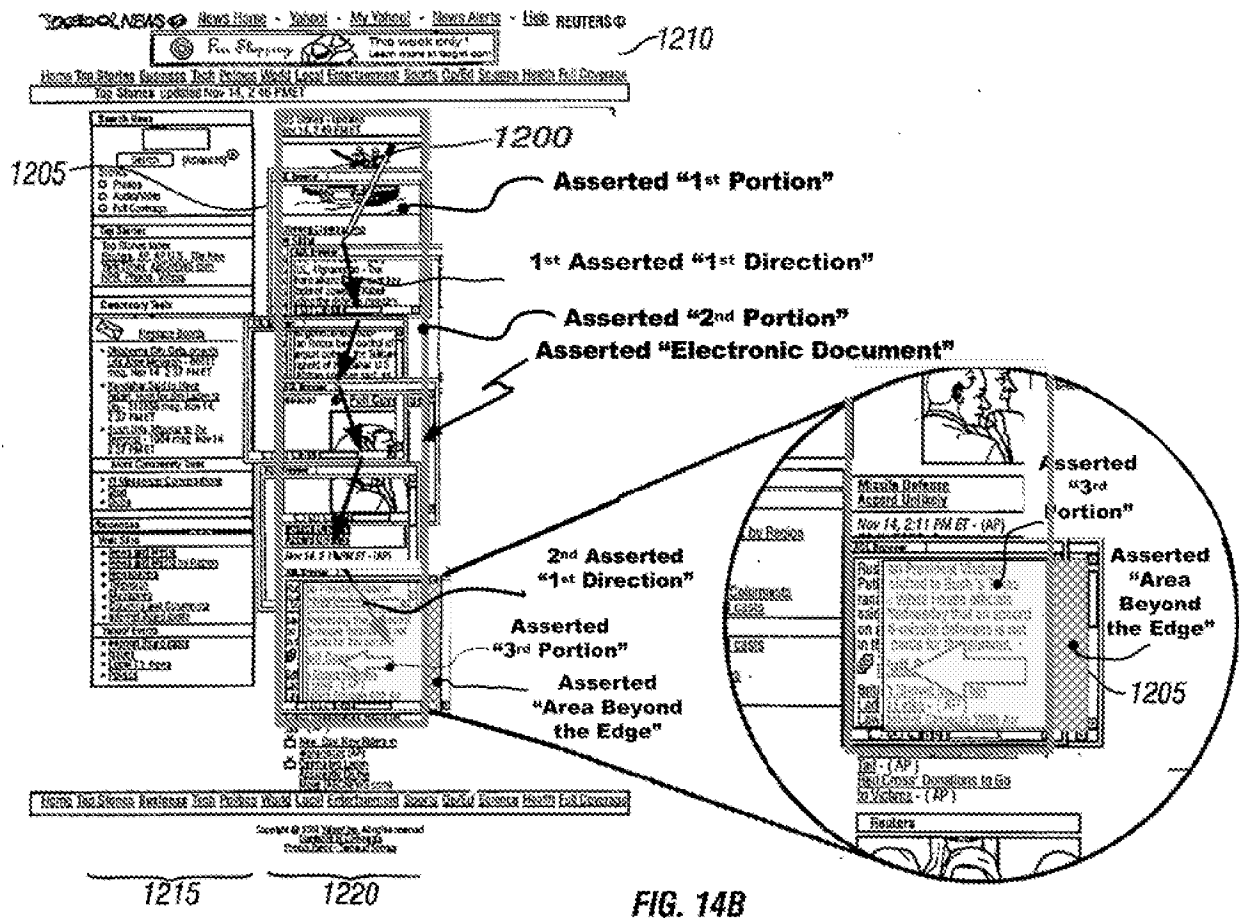

FIG. 14B

In **Figure 14B**, the black arrows within column **1220** represent the movement of the display down the column according to the user's movement of pen **1200** on the screen intending to scroll down the column **1220** to be read.

The claim requires that both the "second portion" and the "third portion" be displayed "while translating in the first direction." However, as shown in **Fig. 14B**, there are clearly several intermediate changes of direction of translation between the translation in the "first direction" from the display of the first portion to the display of the second portion, and the subsequent later translation in a different direction to the third portion. Thus, between the display of the asserted "second portion" and the display of the asserted "third portion," the document has been translated in several different directions.

All of the arrows shown on **Lira Fig. 14B** do not point in the same "direction." First, the plain meaning of "direction" indicates that each of these arrows points in a different direction. Second, nothing in the '381 specification indicates that these arrows

should be treated as all pointing in the same direction. Third, **Lira** itself teaches that these directions are different, not the same. **Lira**'s "snap"-to-center functionality operates to re-center the column on the display upon liftoff. If the user has wobbled left, **Lira**'s vertical alignment control will snap to the right upon liftoff of pen **100**; if the user has wobbled right, **Lira**'s vertical alignment control will snap to the left upon liftoff; and the distance the column will "snap" depends on just how far to the left or right the scrolling has wobbled. Finally, if the user has scrolled directly downward, with no horizontal wobble, then when pen **100** lifts off the screen the display will not move and no "snap" will be seen. In sum, even **Lira** takes different actions depending on these different translation directions.

It is noted that, even if a user scrolling column **1220** in the "snap"-to-center vertical alignment control mode were, hypothetically, to happen to make only a single inadvertent rightward "wobble" (a basis for rejection which is not set forth in the Office Action), **Lira** would still not meet the elements of Claim 1, for, as explained above in **Section I-3**, no "edge" of the column would be reached in the course of the wobble. Furthermore, as explained above, anticipation must be based on disclosure of all the elements of the claim, not on mere possibilities or probabilities proposed with hindsight knowledge of the claim elements.

E. Lira does not disclose "displaying a third portion of the electronic document . . . smaller than the first portion"

The Office Action contends that **Lira** discloses that the third portion of the electronic document is smaller than the first portion of the electronic document, see Request, Exhibit 6, Part A, pages 10-13. In particular, the office Action contends that **Lira** discloses this claim element by disclosing that the first portion of the electronic document is the first portion of column **1220**, which effectively fills display **1205**, see for example, the Office Action's incorporation of the Request, Exhibit 6, Part A, page 7, or the annotated copy of **Fig. 14B** shown above, which has been annotated to label both the asserted "First Portion" of the electronic document and the asserted "Electronic Document".

The portion of **Fig. 14B** labeled "first portion" is both a portion of webpage electronic document **1210** and a portion of column **1220**. The display of this "first

portion” substantially fills display window **1205**, which establishes a relative size for this “first portion” as compared to the “third portion” discussed immediately below.

Lira is said to disclose “displaying a third portion of the electronic document . . . smaller than the first portion” because the labeled “third portion” is a portion of column **1220** that does not occupy as much of the display as the asserted “first portion” because an asserted area beyond the column is also being displayed, see Request, Exhibit 6, Part A, page 11 (emphasis added):

Lira discloses displaying a third portion of the electronic document that is smaller than the first portion. Continuing the example from the previous steps, as the user continues to drag the display window beyond the edge of the logical column 1220, the display window will increasingly pan over areas of logical column 1225. When this occurs, because the display window is only devoting a portion of its display area to the display of logical column 1220, the third portion of the column 1220 being displayed is smaller than the first portion of column 1220. The annotated Figure 14B below highlights an exemplary third-portion *[sic]* of the electronic document and an exemplary area beyond the edge of the document.

However, as noted above, column **1220** is not an “electronic document,” and is not “the electronic document” of the claim.

Everything that is being displayed at this point in the scrolling is part of the web page, and part of the same electronic document. Myers Decl. ¶¶ 87-88. Therefore, the third portion of column **1220**, even if smaller than the first portion of column **1220**, does not disclose “displaying a third portion of the electronic document, wherein the third portion is smaller than the first portion,” as claimed in Claim 1.

F. Lira does not disclose “in response to detecting that the object is no longer on or near the touch screen display, . . . translating the electronic document in a second direction until the area beyond the edge of the electronic document is no longer displayed”

The Office Action contends that **Lira** discloses this step of Claim 1 as follows, see Request, Exhibit 6, Part A, pages 13-14:

"[A]s the pen 1200 is lifted from the screen" certain actions occur depending on whether the panning operation moving the display from column 1220 to column 1225 has exceeded some threshold.

Specifically, when the user lifts the stylus or finger from the screen, "the logical column 1220 [will] snap into alignment with the display window

1205 as the user stops scrolling. The user can adjust the snap sensitivity by, for example, setting the alignment control to snap to the nearest logical column based on a user-defined threshold. If the user's scrolling does not exceed the threshold, which indicates an intention to continue to view the text column 1220, the display 1205 centers the logical column 1210 as the pen 1200 is lifted from the screen." Lira, p. 15, Ins. 19-25. This snap-to function will move the document in a second direction, as indicated by the arrow in annotated Figure 14B, until the area beyond the edge of the column is no longer displayed. This will result in a fourth portion of the column 1220 being displayed, and will also result in no area of column 1225 being displayed, as shown in Figure 14B[.]

This assertion is incorrect.

As noted above, column **1220** is not an "electronic document," and is not "the electronic document" of the claim. Therefore, the "area beyond the edge of the column" is not the claimed "area beyond the edge of the electronic document."

But, even if column **1220** were "the electronic document" of the claim, and, even if **Lira** discloses the location of the asserted "edge" of column **1220**, **Lira** still does not disclose, in response to detecting that the finger is no longer on or near the touch screen display, translating the electronic document in a second direction until the area beyond the edge of the column is no longer displayed.

The "snap"-to-center column does not translate the electronic document in a second direction *until the area beyond the edge of the column is no longer displayed*. **Lira** discloses that the "snap"-to-center vertical alignment control "centers the logical column **1210** [*sic*]⁶ as the pen **1200** is lifted from the screen," **Lira** page 15, lines 23-25. See Myers Decl. ¶ 87. If the column is centered, its left and right boundaries will both be displayed, because, as noted above, **Lira's** logical columns are no wider than the width of the display window. Therefore, the left and right boundaries of column **1220** will both be in the display equidistant from the center of the display window. However, to the extent the right boundary does not happen to be flush with the right edge of the display window, at least some area beyond the edge of the column will still be displayed.

The Office Action assertion that the logical column **1220** is exactly the same width as the display window does not cure the lack of disclosure in **Lira** for this claim

⁶ **Lira** does not disclose a "column **1210**".

feature. **Lira** certainly never discloses that column **1220** is precisely the same width as the display window. Nor can that inference be drawn from **Lira**'s noticeably inexact drawings, such as **Fig. 14B**, where gaps between columns and even the content of the columns appears and disappears between close-up and faraway displays of the same region of the web page.

And, even if **Lira** had explicitly stated that column **1220** is the same width as the display window, the "snap"-to-center vertical alignment control will center the column whether or not it is exactly the same width as the display window. The control will "snap" the column in the display window "until" the right boundary of the column is coincident with the right edge of the screen only if the column happens, by chance, to be exactly the same width as the display window.

Worse yet, the Office Action concedes that, in order for the area beyond the column to be no longer visible after the "snap"-to-center in **Lira**, still more unguaranteed, unpredictable events must occur.

The Office Action concedes, as noted above, Request, Exhibit 6, Part A, pages 13-14 (emphasis added), that after liftoff of the pen, "certain actions occur depending on whether the panning operation . . . has exceeded some threshold." The Office Action then quotes **Lira** at page 15, lines 21-25 (emphasis added), which discloses that:

[t]he user can adjust the snap sensitivity by, for example, setting the alignment control to snap to the nearest logical column based on a user-defined threshold. If the user's scrolling does not exceed the threshold, which indicates an intention to continue to view the text column 1220, the display 1205 centers the logical column 1210 as the pen 1200 is lifted from the screen."

Thus, even taking the rejection on its own terms, and setting aside whether a column is "the electronic document" of the claims at all, for just this one step of the claim to occur in the operation of **Lira**'s alignment control, at least two unguaranteed events must occur first:

- (i) the column must be set to a width that is not simply no wider than the width of the display window, but exactly the same as the width of the display window; and
- (ii) the user's scrolling must wobble to an extent that does not exceed a user-defined threshold of snap sensitivity.

Without the application of impermissible hindsight, this posited chain of coincidence does not disclose “translating the electronic document in a second direction until the area beyond the edge of the electronic document is no longer displayed” under 35 U.S.C. § 102. “For a prior art reference to anticipate a claim, the reference must disclose each and every element of the claim with sufficient clarity to prove its existence in the prior art.” *Motorola, Inc. v. Interdigital Tech. Corp.*, 121 F.3d 1461, 1473 (Fed. Cir. 1997). **Lira** must be read as it would have been by one skilled in the art, but the knowledge that existed before the invention “does not grant a license to read into the prior art reference teachings that are not there.” *Id.* (emphasis added).

For these reasons, **Lira** does not disclose “in response to detecting that the object is no longer on or near the touch screen display, . . . translating the electronic document in a second direction until the area beyond the edge of the electronic document is no longer displayed” as recited in Claim 1.

III. Lira does not disclose the subject matter of dependent Claims 2-6, 8-12, and 16

As **Lira** fails to disclose every limitation of independent claim 1, dependent claims 2-16 are each allowable for at least the reasons stated above with respect to claim 1.

Additional reasons why certain of dependent claims 2-16 are allowable over **Lira** are set forth below.

A. Lira does not disclose claim 6's additional subject matter, “wherein the electronic document is a web page.”

The Office Action asserts that **Lira** anticipates claim 6 on the ground that “*Lira* discloses that the electronic document is a web page,” Request, Exhibit 6, Part A, page 18.

Patent Owner agrees with the Office that **Lira** discloses that the electronic document is a web page.

However, the fact that **Lira** discloses that the electronic document is a web page is not a ground that could support finding claim 6 anticipated, because it is irreconcilable with the basis of the Office’s rejection of claim 1.

Specifically, as discussed below, the Office asserts that Claim 1 is anticipated because “the electronic document” is not a web page, but rather, a logical column embedded in a web page.

As a textual matter, it is clear that “the electronic document” recited in the claims cannot be both a web page and a logical column embedded in a web page, for this would violate the doctrine of antecedent basis that “the electronic document” must correspond to a single thing throughout the claim.

Moreover, the Office’s reasoning that claim 1 is anticipated when “the electronic document” is a logical column of a web page requires the remainder of the web page to not be “the electronic document.” If both the logical column and the web page were “the electronic document” in the same claim, then the area beyond the asserted boundary of the column could not be an “area beyond the edge of the document.”

The rejection of claim 6 is based on asserting that “the electronic document” must read on **Lira**’s column **1220** in independent claim 1, and the web page in dependent claim 6.

For this reason, there is no *prima facie* case of anticipation of claim 6 stated in the Office Action. Patent Owner respectfully traverses this rejection and requests that it be withdrawn.

If this rejection is maintained, patent owner respectfully requests that the office action be reconsidered and withdrawn.

B. Lira does not disclose claim 9’s additional subject matter, “wherein the electronic document includes a list of items.”

Nothing in the disclosure of Lira anticipates “wherein the electronic document includes a list of items” as claimed in claim 9, which is dependent on independent claim 1. According to an annotated figure in the Office Action incorporated from the Request, the alleged “List of Items” in Lira appears to be the text of a news article that happens to appear in **Fig. 14B**, see Request, Exhibit 6, Part A, page 23 (excerpt of figure annotated by Requester):

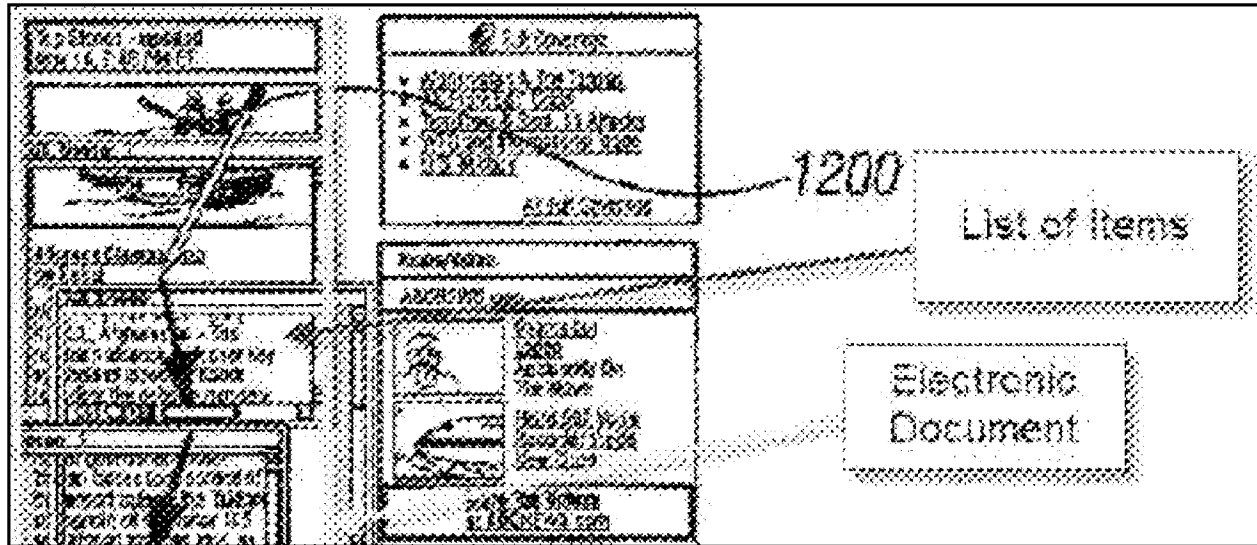

This argument is notably unsupported by any explanation of how this depicted text of what appears to be a news article, as a small, unlabeled and undiscussed portion of a noticeably crude drawing, qualifies as a clear disclosure to persons of ordinary skill of the translation as claimed of an electronic document including a “list of Items” within the terms of the ’381 patent. Further, there is no written description in **Lira** describing lists of items at all, including with reference to **Fig. 14B**. Absent any actual disclosure of a scrollable “list of Items,” **Lira** does not disclose the subject matter of claim 9.

C. Lira does not disclose claim 10’s additional subject matter, “wherein the second direction is opposite the first direction.”

The Office Action asserts that **Lira** anticipates claim 10 because **Lira’s Fig. 14B** “snap”-to-center vertical alignment control implementation anticipates claim 1. However, as Professor Myers points out in his declaration, the web page in **Lira Fig. 14B** has been translated in several different directions which the requester erroneously describes as the “first direction.” Myers Decl. ¶¶ 79-80. Even accepting as true the requester’s characterization of the various directions of movement depicted in **Lira Fig. 14B** (excerpted below), the asserted “second direction,” which is indicated by a white arrow pointing to the left, is not “opposite the [asserted] first direction,” which is indicated by a black arrow pointing diagonally to the lower right:

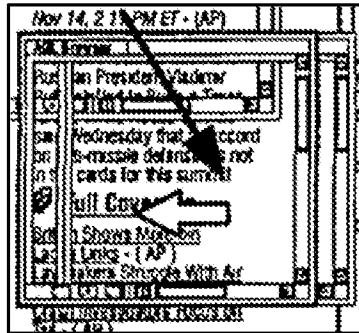

Accordingly, **Lira** is not shown to disclose the subject matter of claim 10.

The Office Action goes on to theorize that, in **Lira's Fig. 14B** "snap"-to-center vertical alignment control implementation, it is possible, although not shown in **Fig. 14B** or discussed in **Lira**, that "the first direction" of scrolling can be "a horizontal translation only to the right," Request, Exhibit 6, Part A, line 24. To the contrary, **Lira** discloses no alignment control that can possibly "snap" in a second direction that is opposite the first direction, but only controls for making minor lateral adjustments orthogonal to the first direction.

As noted above, **Lira's Fig. 14B** "snap"-to-center vertical alignment control implementation is said to control, not horizontal translation, but vertical translation. The stated purpose, and the only disclosed purpose, of **Lira's Fig. 14B** "snap"-to-center vertical alignment control implementation is to assist in correcting wobble that is not in the intended direction of translation. Indeed, **Lira's Fig. 14B** "snap"-to-center vertical alignment control implementation would prevent horizontal translation altogether, unless a sensitivity threshold were exceeded.

Not only does **Lira** not explain how **Lira's Fig. 14B** "snap"-to-center vertical alignment control implementation would work in horizontal translation, **Lira** indicates that it would not be used in horizontal translation, and briefly mentions a separate "horizontal alignment control" it says could be used "when scrolling horizontally," **Lira** page 16, lines 1-3. However, such a horizontal alignment control, described as "similar" to the vertical alignment control, would not "snap" in the opposite direction from the first direction of horizontal translation, any more than the vertical alignment control can "snap" in the opposite direction from the first direction of vertical translation.

Therefore, **Lira** does not anticipate claim 10.

IV. Lira does not disclose the subject matter of independent Claims 19 and 20

Nothing in **Lira** anticipates independent claim 19, or independent claim 20, for at least the same reasons set forth above with respect to claim 1.

REJECTION B:***Claim Rejections - 35 USC §103***

Issued claims 7 and 13-15 stand rejected under 35 U.S.C. 103(a) as being said to be obvious over **Lira**.

The following claim mappings in the Request are incorporated by reference:

Claims 7 (Request Pages 43-44, Exhibit 6, Part B, Pages 1-6)

Claims 13-15 (Request Pages 45-47, Exhibit 6, Part B, Pages 1-2, 6-9)

The rejection is respectfully traversed.

I. Lira Does Not Support a *Prima Facie* Rejection of Claims 7 and 13-15

To establish prima facie obviousness of a claimed invention, all the claim elements must be taught or suggested by the prior art. *In re Royka*, 490 F.2d 981, 180 USPQ 580 (CCPA 1974). Indeed, the Board of Patent Appeal and Interferences has repeatedly confirmed that a proper obviousness determination requires an Examiner to make "a searching comparison of the claimed invention - including all its limitations - with the teaching of the prior art." See *In re Wada and Murphy*, Appeal 2007-3733, citing *In re Ochiai*, 71 F.3d 1565, 1572 (Fed. Cir. 1995) (emphasis in original) (citing *In re Ochiai*, 71 F.3d 1565, 1572 (Fed. Cir. 1995) (emphasis in original); *In re Wehling et al.*, Appeal 2009-8111; and *In re Nakhamkin*, Appeal 2012-003291. Finding all the claim elements in the prior art is necessary, but not sufficient. *KSR Intern. Co. v. Teleflex Inc.*, 127 S.Ct. 1727, 1741 (2007) ("a patent composed of several elements is not proved obvious merely by demonstrating that each of its elements was, independently, known in the prior art"). "All words in a claim must be considered in judging the patentability of that claim against the prior art." *In re Wilson*, 424 F.2d 1382, 1385, 165 USPQ 494, 496 (CCPA 1970) (emphasis added).

Lira does not support a *prima facie* obviousness rejection of Claims 7 and 13-15 because it does not teach or suggest all the claim elements of each of the claims. For

at least this reason the obviousness rejection of claims 7 and 13-15 should be withdrawn.

Additional arguments traversing the obviousness rejection of the dependent claims are provided below.

A. Lira Does Not Support a *Prima Facie* Rejection of Claim 7

Nothing in **Lira** renders claim 7 obvious because claim 7 depends from claim 1 and the substitution in claim 1 of a digital image as the electronic document would not diminish the reasons noted above that make claim 1 not anticipated or obvious over **Lira**. **Lira** mentions images only as “page components” along with other content such as text and which can be resized like other page components, see **Lira**, page 9, lines 22-23. **Lira** does not disclose reformatting of an electronic document that is a digital image.

The Office Action asserts that the mere disclosure of web pages that include digital images renders it “obvious to one of ordinary skill in the art to apply the teaching of *Lira* to an electronic document which is a digital image,” Request, Exhibit 6, Part B, page 5 (emphasis added). However, **Lira** teaches that “[r]eformatting may include scaling down images, text size, and other page components,” treating images just like any other reformattable content, **Lira**, page 9, lines 22-23. When **Lira** includes images in its columns in the figures, it does not treat them as electronic documents, or even as columns: they are simply part of the content of the columns.

The '381 patent, like **Lira**, treats digital images as mere content of the electronic document, such as user-interface objects, col. 12, lines 32-38; col. 19, lines 19-20; blocks on a web page, col. 28, lines 62-64; and wallpaper images, col. 27, lines 36-39. Indeed, as described above, the '381 patent specifically describes an example of a web page made up of blocks **3914** described as “graphics (e.g., images),” col. 28, lines 62-64.

Unlike **Lira**, however, the '381 specification also describes other digital images that are electronic documents:

In some embodiments, the electronic document is a web page, as illustrated in **FIGS. 8A-8D**. In some embodiments, the electronic document is a digital image. (*'381 patent at col. 27, lines 7-10*)

...

In some embodiments, the electronic document is a digital image (e.g., digital image **1302**, **FIGS. 13A-13C**). (*'381 patent, col. 31, lines 42-43*)

...

In the example of **FIGS. 13A-13C**, the document is a digital image 1302 that includes an image of a person **1304**. (*col. 32, lines 47-49*)

The '**381** patent proceeds to distinguish the web page, which is an electronic document that includes blocks such as images, from the blocks themselves, which are not electronic documents, see **Figs. 7, 8A to 8C**, col. 28, line 34 to col. 30, line 10.

Further, no possible practical application of **Lira**'s disclosures to an electronic document that "is a digital image" is suggested by the Office Action, and Patent Owner is not aware of any. For example, **Lira** is concerned with reformatting electronic documents into multiple "readable columns of information" within the document that can be read "as if reading a newspaper column," see **Lira** page 10, lines 3-11. However, a single photograph or other digital image could not be reformatted into "logical" columns as disclosed in **Lira** in the way content such as text could be.

In particular, there is no reason why a person of ordinary skill in the art would have been motivated in the first place to apply **Lira**'s assertedly relevant "snap"-to-center alignment control to digital images. **Lira**'s "snap"-to-center alignment control is a specialized tool for helping the user "read[ing] a column . . . of text of the page" using "touch-and-drag scrolling" keep the display aligned with a desired column by correcting for "wobble of the display . . . during vertical scrolling," **Lira** page 14, lines 18-28. When **Lira**'s "snap"-to-center vertical alignment control operates on column **1220** in **Fig. 14B**, it pays no attention to the images in any of the columns, does not do anything in response to them, and does not attempt to align the display window with them. Nothing in **Lira** suggests a motivation to help a user correct such scrolling "wobble" when translating a digital image on the screen, particularly when **Lira**'s own invention ignored the digital images in the columns in question. If anything, by snapping to the column rather than the images in the column, **Lira** teaches away from applying its disclosure to digital images.

Therefore, no prima facie case of obviousness of claim 7 has been made.

B. Lira Does Not Support a *Prima Facie* Rejection of Claim 13

The claim element “wherein the area beyond the edge of the document is black, gray, a solid color, or white” is said, without any support, to be disclosed in **Lira**. Patent owner has not found any such disclosure in **Lira** and therefore traverses this portion of the rejection of claim 13. In particular, at Exhibit 6, Part A, page 6, the claim mapping states merely:

Lira discloses this feature. See Exhibit 6, Part A, claim 13. However, even assuming for the sake of argument that *Lira* does not explicitly state that the area beyond the edge of the displayed column is white, black, gray, or any other solid color, requiring that the edge of the document be a solid color or shade does not add anything of patentable significance to the alleged invention. The area beyond the edge will be dictated by the particular web page column (*i.e.*, document) being scrolled in *Lira*. For example, in Figure 14B, if the background of the web page is a solid color (*e.g.*, white), that will be the color of the area beyond the edge of the document, given that the area beyond the edge will be a portion of the neighboring column 1225. Thus, under this example, the area beyond the edge of the column displayed is a solid color, *e.g.*, white.

Further, **Lira** is said to render obvious the cited claim language because requiring the edge of the document to be a solid color or shade would not add patentable significance. Patent Owner respectfully traverses this aspect of the claim mapping because making the area beyond the edge of the electronic document noticeable to the user is, in part, the satisfaction of the user’s intent, said in ‘381 to be an object of the invention, see for example ‘381 col. 2, lines 26-31 and **Fig. 8C**:

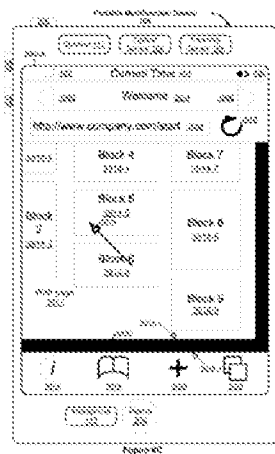

Still further, **Lira** is said to render obvious the cited claim element by disclosing that the appearance of the area beyond the edge of the column, said to be “the electronic document”, is dictated by the background of the web page, Exhibit 6, Part A, page 6. As explained above, **Lira** does not disclose the column to be an electronic document, and never even points to a boundary of a column. Moreover, even if the column **1220** were the claimed electronic document, it is not asserted that **Lira** discloses anything about the color of either column **1220** or its adjoining column.

Further, claim 13 depends from claim 1 which, as noted above, is not anticipated or obvious over **Lira**.

As a result, **Lira** does not render obvious the subject matter of claim 13, “wherein the area beyond the edge of the document is black, gray, a solid color, or white.”

C. Lira Does Not Support a *Prima Facie* Rejection of Claim 14

Lira is said, without expressed support, to disclose “wherein the area beyond the edge of the document is visually distinct from the document”. Applicant respectfully traverses this assertion because no such support has been found or identified.

Further, **Lira** is said to render this feature obvious for two contradictory reasons: on the one hand, requiring the area beyond the electronic document to be visually distinct therefrom is said to not add anything of patentable significance, while on the other hand, providing a sharp contrast from the electronic document is admitted (by the requester) to better convey the display of an area not included in the electronic document, see Exhibit 6, Part A, page 8:

beyond the edge of the document is visually distinct from the document, requiring that the area beyond the edge of the document be visually distinct from the electronic document does not add anything of patentable significance to the alleged invention.

It would have been obvious to choose any color that has a sharp contrast from the document background to clarify to the user that the end of the document has been reached, since an edge can be better conveyed by the application of contrast.

Patent Owner respectfully requests that this rejection be reconsidered and cancelled or, if retained, that the examiner provide a clear statement of his position with regard to whether or not the use of a visual distinction between the electronic document and the area beyond the electronic document has patentable significance.

Still further, the basis of the **Lira** disclosure discussed is, as in claim 13, that the disclosed columns in **Lira** are “the electronic document”. As explained above, **Lira** does not disclose a column to be the electronic document. In fact, the above cited portion of the claim mappings, incorporated by reference in this rejection, discusses the use of contrast between the column and another portion of the electronic document.

As a result, the rejection of claim 14 as obvious over **Lira** is unclear and inconsistent as it cannot be ascertained what the Office considers to be “the electronic document” for purposes of the rejection. Patent Owner respectfully requests that the examiner clarify this rejection in a manner which gives the patent owner a fair opportunity to understand and argue against the rejections.

In any event, claim 14 depends from claim 1 which, as noted above, is not anticipated or obvious over **Lira**.

D. Lira Does Not Support a *Prima Facie* Rejection of Claim 15

With regard now to claim 15, **Lira** is said to render obvious the claimed feature. However, claim 15 depends from claim 1 which, as noted above, is not anticipated or obvious over **Lira**.

II. Objective Indicia Of Nonobviousness Support Patentability

Objective indicia of nonobviousness lend further support to the patentability of claims 7, 13, 14, and 15.

Industry skepticism: Before the release of the iPhone⁷ with its innovative user interface, there was significant skepticism in the industry that a touchscreen phone without a large number of physical buttons could provide an effective user interface.⁸ This is hardly surprising, for many industry observers knew

⁷ The Declaration of Bas Ording under 37 C.F.R. § 1.131 accompanying this response notes that the iPhone embodies the UI features he invented, and which are claimed in the '381 patent. Ording Decl. ¶ 33.

⁸ Olga Kharif, “Another Music Phone? Yawn . . .”, Bloomberg Businessweek, Oct. 18, 2006, http://www.businessweek.com/technology/content/oct2006/tc20061018_099162.htm (noting that “Many analysts are skeptical on the appeal of an iPhone”);

Christopher Meinck, “Palm CEO Remains Skeptical of Apple iPhone”, everythingiCafe, Feb. 20, 2007, <http://www.everythingicafe.com/palm-ceo-remains-skeptical-of-apple-iphone/2007/02/20/> (“for businesspeople the touch-sensitive screen without a physical

of or had even participated in attempts to introduce such products into the marketplace.

Acclaim: Since the public release of the iPhone in 2007, there has been wide praise or industry acclaim for Apple's user interface technology, as implemented on its iPhone, iPod touch, and iPad products.⁹ The inventions of the '381 patent contributed to the intuitive, elegant user interface that was credited with helping make the iPhone a success.

Copying: The iPhone's UI features, including those claimed in the '381 patent, were not only admired by Apple's competitors, but copied for competing products. In the recent jury trial in the Northern District of California on infringement claims that included the '381 patent, it was shown, and has since been widely reported, that, among Apple's competitors, Samsung had specifically reviewed the '381 invention as "a 'bouncing' visual effect" which "generates fun for the user," and expressed a strong desire to improve its own user interface in that respect.¹⁰ Furthermore, in the same jury trial, the jury, in addition to finding asserted claim 19 of the '381 patent not invalid, found, based on internal Samsung documents introduced as evidence at trial, that Samsung intentionally copied numerous features of Apple's user

button keyboard will be a challenge . . . We've learned and struggled for a few years here figuring out how to make a decent phone. PC guys are not going to just figure this out. They're not going to just walk in").

⁹ Steve Jobs, iPhone Introduction, <http://www.youtube.com/watch?v=6uW-E496FXg>, at 16:16 – 16:33 (audience reaction and statement "isn't that cool, do a little rubber-banding up when I went off the edge?")

Lev Grossman, "Invention of the Year: The iPhone," Time, Nov. 1, 2007, http://www.time.com/time/specials/2007/article/0,28804,1677329_1678542_1677891,00.html;

Engadget, "Ten Gadgets that Defined the Decade," Dec. 30, 2009, <http://www.engadget.com/2009/12/30/ten-gadgets-that-defined-the-decade/>;

Tom Krazit, "Apple's iPhone Wins Second J.D. Power Award," April 30, 2009, http://news.cnet.com/8301-13579_3-10231135-37.html.

David Pogue, "The iPhone Matches Most of Its Hype," NY Times, June 27, 2007, http://www.nytimes.com/2007/06/27/technology/circuits/27pogue.html?pagewanted=1&_r=1&ref=iphone;

Korea JoongAng Daily, "Apple's iPhone Tops List of Innovative Inventions," Feb. 18, 2008, <http://joongangdaily.joins.com/article/view.asp?aid=2886322>; and

Walter Mossberg & Katherine Boehret, "Testing Out the iPhone, The Wall Street Journal, June 27, 2007, <http://online.wsj.com/articles/SB118289311361649057.html>.

¹⁰E.g., <http://docs.justia.com/cases/federal/district-courts/california/candce/5:2011cv01846/239768/1370/0.pdf?ts=1343381455>.

interface, specifically including the features disclosed and claimed by the '381 patent.¹¹

Long felt need: As noted in Professor Myers' declaration, the problems of user interfaces for use on smaller displays, such as the "Desert Fog" phenomenon, have been well-documented. He refers to a 2011 article by Benjamin Bederson of the University of Maryland's Human-Computer Interaction Lab (see Myers Decl. ¶ 16) in which Dr. Bederson discussed how "the essential problem of getting lost in Desert Fog has not been consistently avoided," and that, as a result, user interfaces often adopted the 'pinning' solution that did not "let a user navigate beyond the actual content." (Bederson (cited in Myers Decl. ¶ 16) at 4-5).

Failure of others: In the same article, Dr. Bederson identified a number of previous user interfaces for smaller displays and noted that "none of them have been great commercial successes (defined either monetarily or by large numbers of users)." (Bederson (cited in Myers Decl. ¶ 16) at 3).

For these additional reasons, including (1) indisputable widespread praise of the iPhone's user interface, (2) initial expressions of disbelief or skepticism by experts in the field, (3) copying, (4) long felt need, (5) failure of others, and (6) commercial success, the claimed inventions are nonobvious over **Lira**.

REJECTION C:

The office action does not include a Rejection C. If such a rejection was intended, patent owner respectfully requests that the office action be reconsidered and withdrawn if the missing section is to be included.

REJECTIONS OVER ORDING

REJECTION D:

Claim Rejections- 35 USC§ 102(e)

Claims 1-5, 9-13, and 15-20 stand rejected under 35 U.S.C. § 102(e) as being anticipated by U.S. Patent No. 7,786,975 to Ordning et al. (**Ordning '975**). OA 5-6.

The following claim mappings in the Request stand incorporated by reference:

¹¹ <http://www.theverge.com/2012/8/24/3266813/apple-vs-samsung-jury-final-verdict-form>.

| | |
|---------------------|---|
| <u>Claims 1-5</u> | (Request Pages 61-77, Exhibit 6, Part D, Pages 1-20) |
| <u>Claims 9-13</u> | (Request Pages 78-80, Exhibit 6, Part D, Pages 22-27) |
| <u>Claims 15-18</u> | (Request Pages 80-85, Exhibit 6, Part D, Pages 27-36) |
| <u>Claims 19-20</u> | (Request Pages 61-77, Exhibit 6, Part D, Pages 33-38) |

The rejection is respectfully traversed.

I. Ording '975 is not prior art under 35 U.S.C. § 102(e) as to Claims 1-5, 9-13, or 15-20

Ording '975 bears a filing date of December 23, 2005, and is not a U.S. patent or a U.S. patent application publication claiming the same patentable invention as defined in 37 C.F.R. § 41.203(a). Accordingly, the rejection based on **Ording '975** is overcome by a declaration under 37 C.F.R. § 1.131 showing prior invention. See M.P.E.P. § 706.02(b).

In accordance with 37 C.F.R. § 1.131, a declaration is provided by Mr. Ording, the sole inventor of the '**381** patent, a second declaration is provided by Mr. Ording's colleague Mr. Greg Christie, and a claim mapping is provided in Exhibit 1 of this Response, to establish invention of the subject matter of Issued Claims 1-5, 9-13, and 15-20 prior to the effective date of the **Ording '975** reference on which the rejection is based.

The declarations of the sole inventor Mr. Ording and his supervisor Mr. Christie establish the following:

Conception on or before May 14, 2005: Mr. Ording's declaration establishes that he conceived and tested all the elements of the inventive subject matter of Claims 1-5, 9-13, and 15-20 before May 14, 2005, see Ording Decl. ¶¶ 2-30.

As shown in Mr. Ording's declaration, ¶ 39, Mr. Ording records much of his work in electronic files rather than paper documents, consistent with regular practice at the company. To further show that Mr. Ording conceived the invention on or before May 14, 2005, Mr. Ording's declaration describes and attaches the following documents:

Exhibit A: a May 15, 2005 email from Mr. Christie, copying Mr. Ording, about a successful demonstration of the invention witnessed by Mr. Christie;

Exhibit B: a printout of computer scripts Mr. Ording wrote before May 14, 2005 that, when executed, operated a touch screen computer to perform steps of the invention;

Exhibits C-E: information retrieved from Mr. Ording's computer showing his authorship and date of last modification of the code in Exhibit B;

Exhibit F: a printout of computer scripts Mr. Ording wrote and last modified in May 14, 2005 that, when executed, operated a touch screen computer to perform or embody all elements of Issued Claims 1-5, 9-13, and 15-20, as discussed below; and

Exhibits G-I: information retrieved from Mr. Ording's computer showing his authorship and date of last modification of the code in Exhibit F.

The physical equipment in question is available for confirmation by viewing and will be brought to the USPTO if so requested by the examiner.

The accompanying declaration of Mr. Christie, Mr. Ording's supervisor at Apple at all relevant times, further establishes that Mr. Christie witnessed Mr. Ording's development and testing of the invention on or before May 14, 2005, see Christie Decl. ¶¶ 1-11.

Furthermore, a **claim chart** is attached as **Exhibit 1** hereto, prepared by the undersigned with assistance from Mr. Ording, see Ording Decl. ¶¶ 37-47.

The chart sets forth in detail the correlation between the Issued Claims and the May 14, 2005 code attached as Exhibit F to Mr. Ording's declaration.

Reduction to practice by May 15, 2005: As shown in Messrs. Ording and Christie's declarations, the invention claimed in '381 patent was diligently developed and successfully tested, consistent with Apple's practices, in the form of an interactive user interface ("UI") demonstration, by moving a finger on the screen of a touch screen demonstration device and observing whether the UI functioned, see Ording Decl. ¶¶ 20-30. Mr. Ording's invention was reduced to practice at least by a successful test of UI code that Mr. Ording wrote and last

modified May 14, 2005, when it was successfully tested and demonstrated by Mr. Ording to Mr. Christie on May 14, 2005, and used by Steve Jobs in a demonstration of Mr. Ording's invention in front of nearly 100 Apple employees on May 15, 2005, see Ording Decl. ¶¶ 23-31.

As shown in the attached declaration of Mr. Christie, Mr. Christie participated in and personally witnessed the successful testing of the invention, at least as early as the eve of the May 15, 2005 demonstration by Mr. Jobs, by viewing the operation of the UI on a touch screen device and confirming that successful testing in writing, see Christie Decl. ¶¶ 12-14. Mr. Christie's contemporaneous email about the demonstration establishes that he witnessed the reduction to practice of Mr. Ording's invention by May 14, 2005, see Christie Decl. ¶ 14, Exhibit A.

Furthermore, the claim chart attached as **Exhibit 1** to this Response establishes the correspondence between the Issued Claims and the code written by Mr. Ording as of May 14, 2005, and operated in Mr. Jobs's successful demonstration of Mr. Ording's invention on May 15, 2005.

In accordance with 37 C.F.R. § 1.131, because the above declarations, documents, and claim mapping establish that the inventive subject matter of Claims 1-5, 9-13, and 15-20 was conceived and diligently reduced to practice on or before May 15, 2005, a date well before the Ording '975 reference's December 23, 2005 filing date, the Ording '975 reference is not available as prior art against the Issued Claims. Withdrawal of all rejections based thereon is respectfully requested.

II. Ording '975 does not disclose the subject matter of Claims 1-5, 9-13, or 15-20

Even if **Ording '975** were available as prior art, it would not anticipate.

A. Ording '975's Disclosure

Ording '975 discloses an approach to scrolling a list of information on a touch screen display permitting acceleration of movement of the contact point to accelerate scrolling speed. In certain embodiments, the direction of scrolling may reverse in response to the scrolling list intersecting a virtual boundary corresponding to a terminus

of the list, see, e.g., Myers Decl. ¶ 95, **Ordning '975** col. 2, lines 7-11 and col. 6, lines 57-62.

Ordning '975's chief focus is on scrolling lists smoothly and at different speeds on user interfaces for touch-sensitive displays, not on how scrolling may behave if either end of the list is reached, see **Ordning '975** col. 1, line 50 to col. 2, line 29. **Ordning '975** hardly mentions the size of the displayable list relative to the size of the display window. While **Ordning '975** mentions the existence of a beginning and end of a list, and the first and last item of lists, it never actually identifies any of them in any of its drawings, see Myers Decl. ¶ 95. Moreover, **Ordning '975** specifically explains that “the scrolling of the list of items may correspond to a simulation of a cylinder rotating about its axis,” col. 4, lines 6-13, *i.e.*, may be scrollable endlessly by rotating the simulated cylinder, so that scrolling past the end of the list will simply bring the beginning of the list into view and vice versa. Myers Decl. ¶¶ 97-98, 111, 122. Examples of such lists include the current Clock Timer app on the iPhone, and the hypothetical “cylindrical” list depicted below.

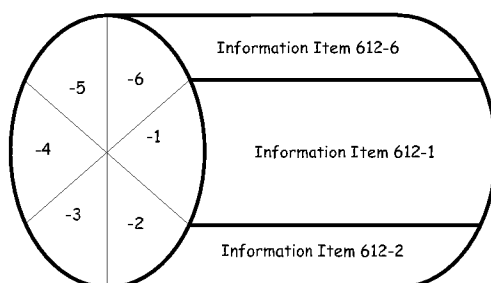

Ordning '975 discloses reversing the direction of scrolling when the scrolling list intersects “a virtual boundary corresponding to a terminus of the list,” see col. 4, lines 44-51, col. 9, lines 18-21. The “terminus of the list” is a virtual boundary associated with the displayed objects of the list, see col. 9, lines 18-21, but in the embodiments in which it is described, it is not itself the beginning or the end of the list or even an item on the list, for the “terminus” does not scroll with the list and the distance between items on the list and the terminus of the list vary as the list is scrolled, see **Ordning '975** col. 9, lines 15-35; **Figs. 7A-7C**; Myers Decl. ¶ 100.

Rather, it appears from **Ordning '975** that the virtual boundary of the terminus may be associated with whichever displayed objects of the list are desired. For

example, in reference to one embodiment, **Ordning '975** states when a list of items on a touch-sensitive display is scrolled in response to movement on the display, one of several operations may occur, including that “when the list is scrolled to its beginning or end, the scrolling list may appear to bounce again at a boundary and reverse direction,” col. 6, lines 50-63; **Fig. 1**. The next sentence states that “[a]fter the bounce or scrolling operation reversal, the scrolling may automatically stop so as to leave the first or last item of the list in view on the touch-sensitive display,” see col. 6, lines 63-65. However, this operation is not shown in the figure for this embodiment, and is not identified in any figure in **Ordning '975**. See Myers Decl. ¶¶ 103-104.

In reference to the embodiment said to correspond to **Figs. 7A-7C, Ordning '975** states that “**Figs. 7A-7B** illustrate the scrolling of a list of items to a terminus of the list, at which point one or more displayed items at the end of the list smoothly bounce off the end of the display, reverse direction, and then optionally come to a stop,” col. 9, lines 9-12. This list includes “[o]ne or more displayed objects such as information object **612-1**,” col. 9, lines 16-17, which may “reach or intersect with the terminus **714**” in **Fig. 7B**, at which time “the movement corresponding to the scrolling may stop,” and “the information [sic] **612-1** may subsequently reverse direction”, col. 9, lines 9-27.

B. Ordning '975 does not disclose the subject matter of claim 1

- 1. Ordning does not disclose “displaying an area beyond the edge of the document” “in response to an edge of the electronic document being reached while translating the electronic document in the first direction while the object is still detected on or near the touch screen display.”**

Ordning '975 contains no explicit discussion, or even mention, of displaying an area beyond the edge of the document. **Ordning '975** discloses that the display window “may be used to display a list of items” and that “[i]n response to a determined movement of the point of contact, the list may be scrolled,” at column 3, line 61 to column 4, line 1, but not that scrolling the displayed list can result in displaying an area beyond the list.

The rejection relies on the assertion, made in the Request, that **Ording '975** implicitly discloses the display of an area beyond the list in **Figs. 7A-7C**. Patent Owner respectfully traverses these assertions as unsupported.

According to the Requester's claim mapping, at Request Ex. 6, part D, pages 8-9, **FIG. 7A** depicts the "first item" on the list as information item 612-1 and also displays "an area beyond the edge of the document." The claim mapping proceeds to annotate this figure to purportedly highlight "an area beyond the edge."

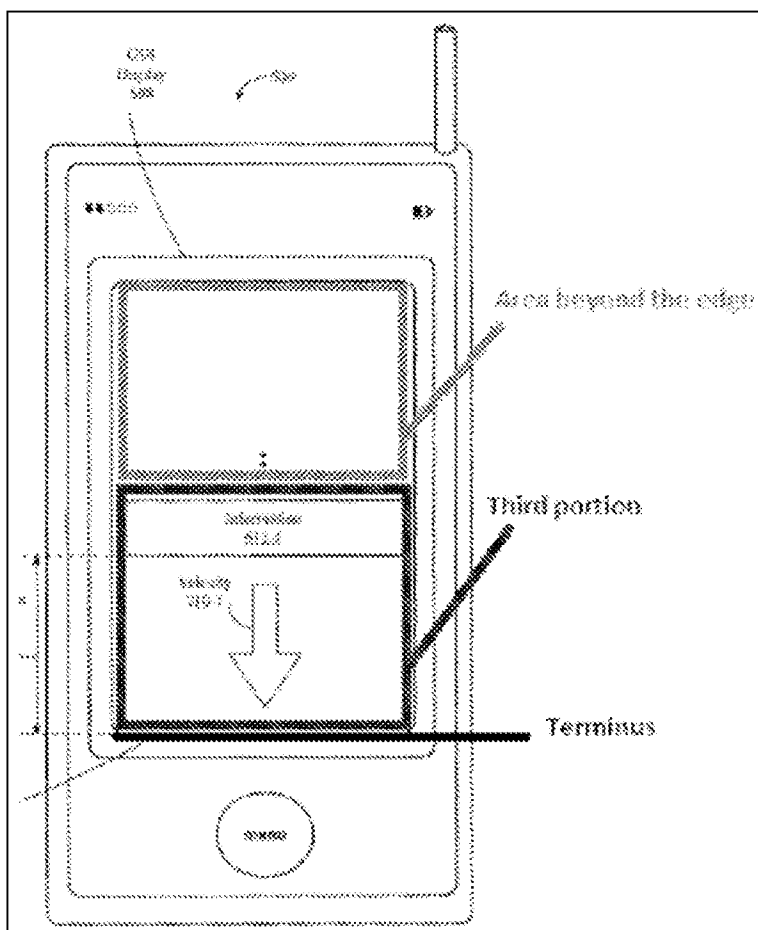

Ording '975 FIG. 7A (as annotated by Requester)

However, **Ording '975** never describes information item **612-1** as the first item of the list. Myers Decl. ¶¶ 90, 99. And Requester elsewhere concedes, Ex. 6, Part D, page 6 (emphasis added), that **Ording '975** shows information item **612-1** as one of "four information items from a larger list." That conceded "larger list" is depicted more

fully in **Ording '975 Fig. 6**, and indicates that the list continues above information item **612-1**.

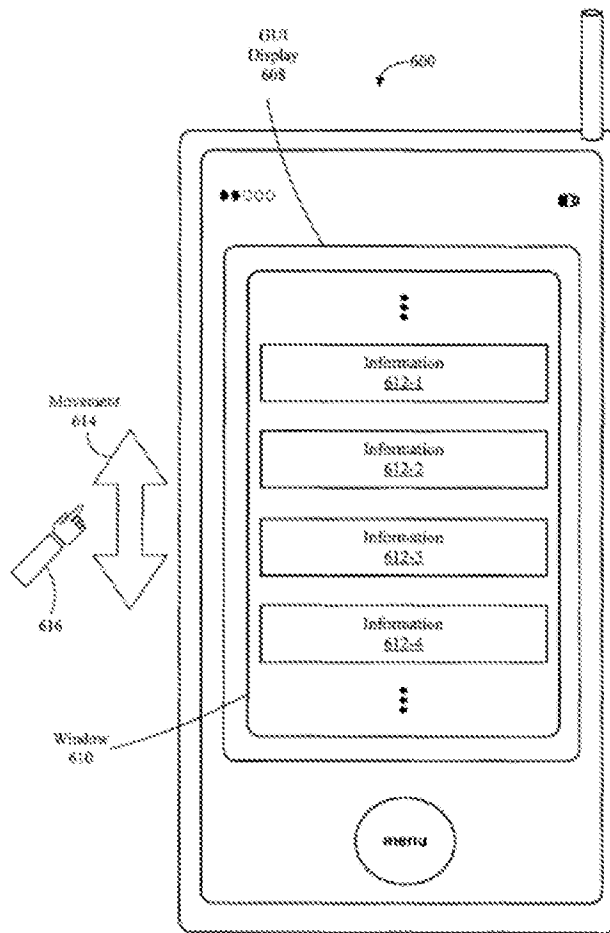

Figure 6

Moreover, the Requester's assertion that **Ording '975 Fig. 7A** silently depicts an "area beyond the edge" above information item **612-1** rather than a continuation of the list is belied by the figure itself. Just as **Ording '975 FIG. 6** shows that the list continues in both directions from information items **612-1** to **612-4** by vertical ellipses above information item **612-1** and below information item **612-4**, inconsistent with those areas being empty of items to display, the same ellipsis also appears in **Ording Fig. 7A** in the very area incorrectly said by requester to have "no items" to display. Indeed, similar ellipses also appear in **Figs. 11A-11E**, all of which indicate not an absence of displayable content in an area beyond the list, but exactly the opposite. Myers Decl. ¶¶ 106-109. Thus, it is perfectly consistent with **Ording '975** for information item **612-1**

in **FIG. 7A** to have numerous items ahead of it in the list, with the other displayed items above it simply not individually shown. Myers Decl. ¶ 109.

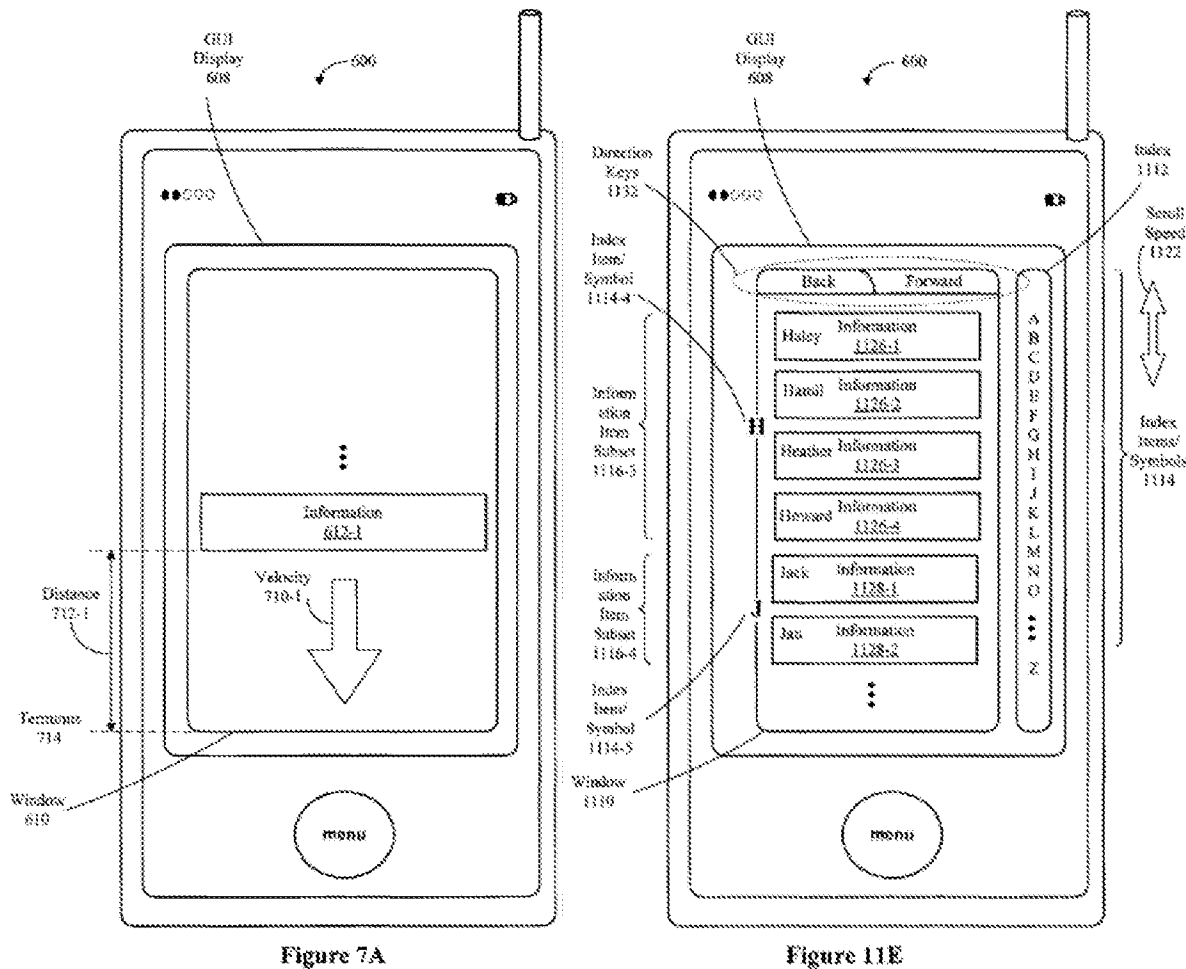

Figure 7A

Figure 11E

Even if information item **612-1** were the first item of the list, it would still be consistent with the disclosure for list items to be displayed above it rather than any unmentioned area beyond an edge of the list. For example, the list in **Fig. 7A** might be the list described at column 4, lines 6 to 13, that simulates an axially rotating cylinder when scrolled so that scrolling past the end of the list will merely cause the beginning items of the list to be displayed. Myers Decl. ¶¶ 97-98, 111, 122.

The Request asserts at Ex. 6, Part D, page 7-8, that **Ording '975** discloses in another embodiment a region "outside of" and "above or below" the list "that is displayed while translating the document (*i.e.*, during scrolling)," and argues that this embodiment lends support to interpreting **FIG. 7A** as showing an area above the first item of the list.

The Request turns for support to **Ordning '975's** disclosure at column 10, lines 61 to 63, that “[t]he display **608** may include a window **1110** containing a plurality of objects corresponding to a list of information items,” and at column 11, lines 30 to 54, that a symbol corresponding to an information item subset of the list may also be displayed in “the window **1110**,” “adjacent to the information **1124**,” “at a mid-point of the window **1110**,” “at or near an upper edge of the window **1110**, as illustrated in **FIG. 11D**,” or “at or near an upper edge of the window **1110** in a banner.” However, none of these virtual regions are disclosed in any area above or below any information items on the list; all of them are to one side of the list, and none suggests any possibility of allowing the user to scroll past an “edge” of the list.

Indeed, **Ordning '975's** disclosed “bounce” behavior if a beginning or end of the list is reached would clearly prevent any area beyond the list from being seen, by reversing the scrolling before any such area, if it existed, could reach the display. As Professor Myers explains in his Rule 132 declaration, **Ordning '975** mentions a “beginning or an end of the list of items” that may be “reached,” but what occurs when this “beginning or an end of the list of items is reached” is that “a displayed portion of the list of items may appear to bounce off of a boundary of the window in the touch-sensitive display,” col. 4, lines 47-51 (emphasis added). Bouncing off the boundary of the window is entirely unlike the claims of the **'381** patent, which permit a document to continue translating without an immediate change in direction when the edge of the document is reached, and only later translate in a second direction. Myers Decl. ¶ 124.

Finally, even if **Ordning '975** identified any “edge” of the list or displayable “area beyond” such an edge, there is no indication of any such area being displayed in response to an “edge” of the list being reached. Even if the “beginning or . . . end of the list of items” were the “edge” of the list, the only scrolling behavior that **Ordning '975** discloses in response to reaching it is not to continue scrolling in the first direction, but to reverse the scrolling direction, exactly the opposite of what the **'381** patent claims. Myers Decl. ¶ 125.

2. Ordning '975 does not disclose “displaying a third portion of the electronic document . . . smaller than the first portion.”

As noted above, the Requester's assertion that **Ordning '975** discloses the display of an area beyond an edge of the list is incorrect. Thus, in every display of list items in **Ordning '975**, it is consistent with **Ordning '975** for the entire display to be filled with displayed list items. If so, the displayed "third portion" and "first portion" of the list during scrolling are the same size. Myers Decl. ¶ 126.

3. Ordning '975 does not disclose "translating the electronic document in a second direction" "in response to detecting that the object is no longer on or near the touch screen display."

Ordning '975 does not disclose scrolling a list in a second direction, in response to detecting that an object is no longer on or near the touch screen display, for numerous reasons. First, **Ordning '975** never changes the scrolling direction in response to the user's point of contact no longer being detected. On the contrary, **Ordning '975** specifically teaches at column 4, lines 44-46 (emphasis added), that "[t]he direction of scrolling through the list of items may be reversed in response to the scrolling intersecting a virtual boundary corresponding to a terminus of the list." This scrolling reversal, to the extent it is described in **Ordning '975**, is not disclosed as having anything to do with whether the user's finger is or is no longer on or near the touch screen, but merely occurs whenever the list scrolls to a certain point. Myers Decl. ¶ 127.

Not only does **Ordning '975** not disclose changing the direction of scrolling in response to lifting a finger or pen from the display in any circumstances, it discloses exactly the opposite: that when a finger is lifted from a screen, the list continues to "scroll[] after [the] user . . . breaks the contact," col. 7, lines 21-24 (emphasis added), see also col. 1, lines 58-61 and col. 4, lines 34-43, and optionally accelerates, see col. 4, lines 14-26, col. 6, lines 52-54; see Myers Decl. ¶¶ 127-128. **Ordning '975's** method for "stopp[ing]" this continued scrolling after liftoff is to bring the finger back down to the screen again, col. 6, line 65 to col. 7, lines 1, 21-22. Stopping scrolling as a result of touching the display screen does not even resemble the **'381** Issued Claims, in which scrolling changes direction in response to liftoff from the display screen. Myers Decl. ¶ 129.

In the rejection, the Requester asserts, at Ex. 6, Part D, page 14, that in **Ordning '975**, “[a]lthough contact with the terminus by a first list item such as item **612-1** can cause the direction of scrolling to reverse as in *Ordning* Figures 7B-7C, *precedence to the user’s continued contact with the touch screen may be instead given so as to cause information item 612-1 to remain at the terminus*” (emphasis added).

The support advanced for this assertion is a citation to **Ordning '975** column 8, lines 30 to 36, which reads:

The user 310 may break the point of contact and establish a substantially stationary point of contact for at least a pre-determined period of time (410). The device 312 determines the breaking of the point of contact and the establishment of a substantially stationary point of contact (412), and responds by stopping the scrolling (414).

The Request further asserts, at Ex. 6, Part D, pages 12 to 16, that **Ordning '975** discloses that “[p]recedence can be given to the user’s contact with the screen over the item’s contact with the terminus, since *Ordning [’975]* discloses that some operations may be omitted, added, combined or reordered in the context of discussing the terminus and reversing the direction of scroll,” such that, “in response to the user breaking contact with the touch screen (*i.e.*, removing the object so that it is no longer detected), *the override on the scroll reversal is cancelled* and the document is free to scroll in the opposite direction (*i.e.*, move in a second direction)” (emphases added).

The support requester advances for this assertion is a citation to **Ordning '975** column 8, lines 40 to 53, which reads:

FIG. 5 is a flow diagram illustrating an embodiment of a method 500 of scrolling through a list. Operations 314 through 320 are as described above, and furthermore the accelerated scrolling operation 320 may be skipped when the user does not move a point of contact in an accelerated manner. When the scrolling list intersects a virtual boundary corresponding to a terminus of the list, the direction of scrolling is reversed (510), at least momentarily. In some embodiments, the scrolling reverses and then comes to a stop in a damped fashion when the terminus of the list is reached. In 50 [*sic*] other embodiments, the method 500 may include fewer operations or additional operations. In addition, two or more operations may be combined and/or an order of the operations may be changed.

However, these portions of **Ording '975**'s disclosure say nothing about giving "precedence" to the user's contact or continued contact with the touch screen over reversing the direction of scrolling, or about any "override on the scroll reversal" or its cancellation. Indeed, neither of these concepts is found anywhere in **Ording '975**.

Moreover, **Ording '975**'s disclosure contradicts application of such concepts to scrolling reversal. To the extent the statements cited by the request are even relevant to scrolling reversal, **Ording '975** nowhere discloses any combination of operations under which the user's continued contact with the touch screen can "cause information item 612-1 to remain at the terminus," either permanently or until the contact ceases. On the contrary, **Ording '975** teaches at column 9, lines 9 to 13, that when the list of items is scrolled to the terminus of the list, "one or more displayed items at the end of the list *smoothly* bounce off the end of the display, reverse direction, and *then* optionally come to a stop" (emphases added). **Ording '975** further teaches at column 8, lines 22 to 27, that "when the one or more displayed objects, such as the information object **612-1**, reach or intersect with the terminus **714**, the movement corresponding to the scrolling may stop, i.e., the scrolling velocity may be zero *at an instant in time*," and then "may *subsequently* reverse direction." These disclosures are inconsistent with giving "precedence" to the user's contact or continued contact with the touch screen over versing the direction of scrolling.

4. Ording '975 does not disclose "translating the electronic document in a second direction until [an] area beyond the edge is no longer displayed."

Even assuming for the sake of argument that **Ording '975** discloses displaying an area beyond an edge and translating in a second direction in response to liftoff (an incorrect assumption), **Ording '975** does not disclose translating in that second direction until the supposed "area beyond the edge" is no longer displayed.

In **Ording '975**, after the scrolling list reaches and "bounces" at its terminus, the information item **612-1** may retain a reversed velocity **710-2** at a time after reversal, which may or may not be damped; the scrolling may automatically stop so as to leave the first or last items of the list in view on the display; or the scrolling may come to a stop in damped fashion. However, although the scrolling reversal may continue,

dampen, or stop with a first or last item visible, these operations occur irrespective of whether any particular area that is not part of the list is no longer visible. **Ordning '975** never discloses scrolling the list in the reversed direction *until* an area beyond the list is *no longer displayed*.

In **Ordning '975 FIG. 7C**, for example, information item **612-1** is not at the top of the display, and velocity may be damped to zero while information item **612-1** is still below the top of the display. **Ordning '975** teaches at column 8, lines 47 to 49, that after the direction of scrolling is reversed, the scrolling may “come[] to a stop” after reversal “when the terminus of the list is reached,” without having anything to do with whether the user’s finger is or is not on or near the touch screen. **Ordning '975** also teaches at column 6, line 62 to column 7, line 1 that “[a]fter the bounce or scrolling direction reversal, the scrolling may automatically stop so as to leave the first or last item of the list in view on the . . . display,” or “[t]he scrolling may stop when the user breaks the point of contact (e.g., by lifting his/her finger off the display) and then establishing [*sic*] a substantially stationary point of contact for at least a pre-determined period of time (120).” Myers Decl. ¶ 130. None of these behaviors depend on whether an area that is not part of the list is still visible or not.

For at least these reasons, **Ordning '975** does not anticipate claim 1.

C. Ordning '975 does not disclose the subject matter of Claims 2 to 5, 9 to 13, or 15

Ordning '975 does not anticipate claim 2, 3, 4, 5, 9, 10, 11, 12, 13, or 15, for at least the same reasons given above with respect to claim 1. Claims 2 to 5, 9 to 13, and 15 are all dependent on independent claim 1 which, as noted above, is not anticipated by **Ordning '975**.

Further, nothing in the disclosure of **Ordning '975** discloses the claim requirement “*wherein multiple portions of an electronic document are displayed at the same magnification*” as claimed in claim 2, which is also dependent on independent claim 1 as discussed above. **Ordning '975** says nothing about magnification.

Further, nothing in the disclosure of **Ordning '975** discloses the claim requirement “*wherein the area beyond the edge of the document is black, gray, a solid color, or white*” as claimed in claim 13, which is also dependent on independent claim 1 as

discussed above. Even if an “area beyond” an “edge” were disclosed, **Ording '975** says nothing about its hue, and mentions color only in connection with text fonts, col. 5, lines 61-67.

Moreover, **Ording '975** does not disclose changing from translating in the first direction to translating in the second direction until the area beyond the edge of the document is no longer displayed so as to make the edge of the electronic document appear to be elastically attached to an edge of the touch screen display or to an edge displayed on the touch screen display, as claimed in claim 16, which is also dependent on independent claim 1 as discussed above. **Ording '975** discloses at, e.g., column 4, lines 44 to 51, a scrolling reversal in which, for example, during scrolling, a displayed portion of the list of items may appear to bounce off of a boundary of the window in the touch-sensitive display when a beginning or an end of the list of items is reached. **Ording '975** states at column 4, lines 51 to 59, that this “apparent bounce may correspond to a simulation of a viscous or elastic ball having momentum in a first direction striking an immovable and/or inelastic object, such as a wall,” and that “[a] parameter corresponding to the friction term in the simulation may be adjustable allowing the ball to reach equilibrium in contact with the wall . . . or displaced from the wall.” Even if the first item of the list in **Ording '975** were the “edge” of the list, **Ording '975** does not disclose simulation of an elastic attachment between an edge of the list and an edge of the display; rather, it discloses a simulation of an elastic ball bouncing against an immovable wall and either bouncing away or coming to a stop still in contact with the wall.

Further, nothing in the disclosure of **Ording '975** discloses the subject matter of claim 17, which is also dependent on independent claim 1 as discussed above.

Further, nothing in the disclosure of **Ording '975** discloses the subject matter of claim 18, which is also dependent on independent claim 1 as discussed above.

Further, nothing in the disclosure of **Ording '975** discloses the claim requirement “ instructions for displaying a first portion of an electronic document; (f) instructions for translating the electronic document displayed on the touch screen display in a first direction to display a second portion of the electronic document, wherein the second portion is different from the first portion, instructions for displaying an area beyond an

edge of the electronic document and displaying a third portion of the electronic document, in response to the edge of the electronic document being reached while translating the electronic : and (h) instructions for translating the electronic document in a second direction until the area beyond the edge of the electronic document to display a fourth portion of the electronic document”, as claimed in independent claim 19, for the reasons given as to claim 1.

Still further, nothing in the disclosure of **Ording '975** anticipates to “(a) display a first portion of an electronic document; (b) translate the electronic document to display a second portion of the electronic document (c) display an area beyond an edge of the electronic document if the edge of the electronic document is reached while translating the electronic document , and (d) translate the electronic document until the area beyond the edge of the electronic document to display a fourth portion of the electronic document ” as claimed in independent claim 20, for the reasons given as to claim 1.

CONCLUSION

No other issues having been raised, it is believed that claims 1 through 20 are fully in condition to be confirmed by reexamination certificate, and mailing of notice of intent to issue same is courteously solicited.

Date: January 15, 2013

Respectfully Submitted,

/Kenneth J. Weatherwax/

Kenneth J. Weatherwax (Reg. No. 54,528)
Goldberg, Lowenstein & Weatherwax LLP

Application No. 90/012,304

Response to Non-Final Action (January 15, 2013)

Exhibit 1

COMPARISON OF 'addressbook 15q' SCRIPTS WITH CLAIMS

For clarity, parenthetical letters have been added to the text, in a manner consistent with the parenthetical letters added to the text in the request for reexamination.

| | | |
|---|--|--|
| 1. A computer-implemented method, comprising: | The scripts in 'addressbook 15q' (Declaration of Bas Ording, Exhibit F) were executed using the application Director on a computer with a touch screen display. (Ording Decl. ¶ 40) When a user interacted with the touch screen display, the user interface ("UI") for the touch screen display and computer operated in accordance with the instructions in the code. (Ording Decl. ¶¶ 6, 22, 28) | |
| (a) at a device with a touch screen display: | The computer had a touch screen display. (Ording Decl. ¶ 28) | |

| | | |
|--|---|---|
| <p>(b) displaying a first portion of an electronic document;</p> | <p>A data set of names (“name list”) was provided. (Ording Decl. ¶ 21)</p> <p>The “new” function generated the displayable list for scrolling, by defining a displayable list document of a fixed width and height that included a displayable list of the names from “name list”.</p> <p>The scrolling position (“fineScrollPos”) was defined as the position of the top edge of the touch screen display relative to the top of the list. For example, a value of fineScroll = 0.0 indicated that the top edge of the list was at the top edge of the touch screen display.</p> <p>The “new” function set the vertical length of each list item (“pItemHeight”) to 31 pixels, and the top and bottom margins of the list (“topSpace” and “bottomSpace”), analogous to the top and bottom margins of a printed page, at 50 pixels each. The “new” function next defined “pNameCount” as the number of last names in the “name List” dataset.</p> | <pre> on new me, bufferRef pDrawBuffer = bufferRef pViewWidth = pDrawBuffer.width pViewHeight = pDrawBuffer.height topSpace = 50 bottomSpace = 50 pItemHeight = 31 --32 pNameXstart = 12 --+ 18 pNameXend = pViewWidth - 8 - 8 - 3 pMaxNameWidth = pNameXend - pNameXstart fineScrollPos = 0.0 scrollPos = integer(fineScrollPos) pLastNameList = member("name list").text pFirstNameList = member("first name list").text pNameCount = pLastNameList.lines.count selectedID = 0 --generateNameBitmaps me generateBoldNameBitmaps me generateIndexLetters me generateLastNameStrip me </pre> |
|--|---|---|

The “new” function then called “generateBoldNameBitmaps”, which retrieved the names from “name list” into a text file and then converted the text names into “NameBitmaps”, a set of individually displayable images of the names.

The “new” function then called “generateLastnameStrip”, which generated a displayable strip of list items, each a height of 31 pixels (“pItemHeight”), from the bitmap images of the list names. (Ording Decl. ¶ 42) This function called the “new” function in the “strip object” script (“pLastNameStrip = new(script(“strip object”), me)”), which set a blue color (“rgb=245,254, 258”) for the area beyond the list and the list margins.

The “new” function then set the list of last names as the list it would display (“pCurrentStrip= pLastNameStrip”).

The “new” function then defined “listLength” as the sum of the

```

pCurrentStrip = pLastNameStrip

listLength = topSpace + pCurrentStrip.wy.length + bottomSpace

-- generateFirstnameStrip me
-- alternateColors pFirstNameStrip
-- listLength = topSpace + pFirstNameStrip.wy.length + bottomSpace

fitInHeight = pViewHeight - 15 - 15
pIndexTag = generateIndexStrip(fitInHeight)
hasIndexStrip = TRUE

return me
end

on setFineScroll me, scr

fineScrollPos = scr

scrollPos = integer(fineScrollPos)

end

on generateBoldNameBitmaps me

pNameStrings = []
pLastNameStrings = []

pNameBitmaps = []
pLastNameOffsets = []

tagMem = member("name tag")
tagMem.width = pMaxNameWidth
tagMem.height = 23
tagMem.fontSize = 17
tagMem.text = ",A"
pGlyphsWidth = tagMem.charPosToLoc(2).locW

repeat with n = 1 to pNameCount

theName = line n of pLastNameList
theFirstName = line n of pFirstNameList

add pLastNameStrings, theName
add pNameStrings, theFirstName

tagMem.text = theFirstName & " "
tagMem.fontStyle = []

c = theName.word.count

lastNameListPos = 0
***
add pNameBitmaps, duplicate(tagMem.image)

```

vertical length of the displayable list name items ("pCurrentStrip") plus the vertical thickness of the top and bottom margins ("topSpace", "bottomSpace").

```

on generateLastNameStrip me -- LAST name

  lastNameStrip = new(script("strip object"), me)

  letterGroup = 0
  lastLetterNum = 0

  repeat with n = 1 to phoneCount
    theName = lastNameStrings[n]

    letterNum = the charNum of (char 1 of theName)
    if (letterNum <> lastLetterNum) then
      lastLetterNum = letterNum

    if (letterGroup <> 0) then
      calcGroupLength letterGroup
      add lastNameStrip.myLetterGroups, letterGroup
    end if

    -- start new group
    letterGroup = new(script("letter group object"), me, letterNum)
    letterGroup.myItemHeight = pItemHeight
  end if

  add lastNameStrip.myItems, n

end repeat

if (letterGroup <> 0) then
  calcGroupLength letterGroup
  add lastNameStrip.myLetterGroups, letterGroup
end if

calcStripLength lastNameStrip

end

on calcStripLength me
  myLength = 0

  repeat with grp in myLetterGroups
    myLength = myLength + grp.myLength
  end repeat

  grpCount = count(myLetterGroups)
end

on new me, as
  mySuper = me

  kLightBGcol = rgb(245, 248, 254)

  myLetterGroups = []
  myLength = 0

  return me
end

```

| | | |
|--|--|---|
| | <p>The “draw” function in the List Object script was iteratively called (“draw gListObject”) to redraw the document in the display ((Ording Decl. ¶ 43). When called, the “draw” function in the List Object script drew the strip of list items (“pCurrentStrip”) in the rectangle of the display area (“rect(0, 0, pViewWidth, pViewHeight)” with). It did this by first calling the “draw” function in the Strip Object script.</p> <p>The “draw” function in the Strip Object script, based on the current scrolling position (“scrollPos”), calculated the earliest visible item (“startN”). It then called the “draw” function in the Letter Object script (“draw grp, inRect, y”).</p> | <p style="text-align: center;"><u>“Draw” function in <i>list object</i> script</u></p> <pre> on draw me draw pCurrentStrip, rect(0, 0, pViewWidth, pViewHeight), - scrollPos + topSpace --draw pFirstNameStrip, rect(0, 0, pViewWidth, pViewHeight), scrollPos - topSpace </pre> <hr/> <p style="text-align: center;"><u>“Draw” function in <i>strip object</i> script</u></p> <pre> on draw me, inRect, scrollPos y = scrollPos if (y > 0) then r = duplicate(mySuper.pDrawBuffer.rect) r.bottom = y fill mySuper.pDrawBuffer, r, kLightBGcol end if startN = 0 repeat with n = 1 to grpCount grp = myLetterGroups[n] if (y + grp.myLength > inRect.top) then startN = n exit repeat else y = y + grp.myLength end if end repeat inRectFilled = FALSE if (startN > 0) then repeat with n = startN to grpCount grp = myLetterGroups[n] draw grp, inRect, y y = y + grp.myLength if (y > inRect.bottom) then inRectFilled = TRUE exit repeat end if end repeat end if if (not inRectFilled) then if (y < inRect.bottom) then r = duplicate(mySuper.pDrawBuffer.rect) r.top = y fill mySuper.pDrawBuffer, r, kLightBGcol end if end if end </pre> |
|--|--|---|

| | | |
|---|---|--|
| | <p>The “draw” function in the Letter Object script drew the visible name items of the list, starting with the topmost visible item (“startN”) and continuing until it ran out of screen (“if (y > inRect.bottom) then exit repeat”) (“-- draw names”). Each list item was displayed as an image (“pNameBitmaps[nameID]”) of a name (“-- name tag”) displayed, centered vertically, in a white rectangular area (“rgb(255, 255, 255)”), with horizontal lines (“-- bottom line”) between the rectangular areas of a different color (“rgb(240, 240, 240)”).</p> | <p style="text-align: center;"><u>“Draw” function in <i>letter object</i> script</u></p> <pre> on draw me, inRect, yy context = mySuper.pDrawBuffer y = yy *** -- draw names c = count(myItems) if (c > 0) then startN = integer(1.0 * (inRect.top - (yy + myHeaderH)) / myItemHeight + 0.5) if (startN < 1) then startN = 1 if (startN > c) then startN = c x = mySuper.pNameXstart repeat with n = startN to c y = (yy + myHeaderH) + (n - 1) * myItemHeight if (y > inRect.bottom) then exit repeat -- top line --fill context, rect(0, y, inRect.width, y + 1), rgb(240, 240, 240) -- name tag nameID = myItems[n] nameImg = mySuper.pNameBitmaps[nameID] nameRect = nameImg.rect cof = (myItemHeight - nameRect.height) / 2 --- 2 if (nameID = mySuper.selectedID) then fill context, rect(0, y, inRect.width, y + myItemHeight), rgb(0, 82, 233) copyPixels context, nameImg, nameRect.offset(x, y + cof), nameRect, [#bgColor: 0] else copyPixels context, nameImg, nameRect.offset(x, y + cof), nameRect, [#bgColor: 255] -- bottom line fill context, rect(0, y + myItemHeight - 1, inRect.width, y + myItemHeight), rgb(240, 240, 240) end if end repeat end if </pre> |
| <p>(c) detecting a movement of an object on or near the touch screen display;</p> | <p>The “TmouseDrag” function was called by my code if there was movement detected to determine whether a scroll operation was to be performed. This was a function usually handled by a mouse, but which Director would take over for the touch screen when active. (Ording ¶ 44)</p> | <pre> on TmouseDrag me *** if (abs(currentTouchPas.locV - touchPasAtStart.locV) > 10) then scrollTriggered = TRUE touchPasAtStart = lastTouchPas gListObject.selectedID = 0 end if </pre> |

| | | |
|---|---|---|
| | <p>In particular, if a vertical location of the current touch position (<code>currentTouchPos.locV</code>) is greater than the vertical location of an initial touch position (<code>currentTouchPosAtStart.locV</code>) by a specified amount of 10 pixels, then the “TmouseDrag” function determined that scrolling was being performed (<code>hasScrolled = TRUE</code>).</p> | |
| <p>(c1) in response to detecting the movement, translating the electronic document displayed on the touch screen display in a first direction to display a second portion of the electronic document, wherein the second portion is different from the first portion;</p> | <p>The “TmouseDrag” function, in response to movement being detected, scrolled the list in a first direction to display a second portion of the list different from the first portion above.</p> <p>In response to detecting the movement (“if (<code>scrollTriggered</code>)”), the function first set a tentative new scrolling position (“<code>newScroll</code>”) based on:</p> <p><code>startScrollpos</code> [vertical position of top edge of list when finger detected] <i>minus</i> (<code>currentTouchPos.locV</code> [current vertical position of finger] <i>minus</i> <code>touchPosAtStart.locV</code>)</p> | <pre> if (<code>scrollTriggered</code>) then dt = <code>currentTouchTime</code> - <code>lastTouchTime</code> if (dt > 0) then <code>newScroll</code> = <code>startScrollPos</code> - (<code>currentTouchPos.locV</code> - <code>touchPosAtStart.locV</code>) * 1.0 <code>maxScroll</code> = <code>glistObject.listlength</code> - <code>glistObject.pViewHeight</code> if (<code>newScroll</code> < 0) then <code>newScroll</code> = <code>newScroll</code> + 0.5 * (0 - <code>newScroll</code>) if (<code>newScroll</code> > <code>maxScroll</code>) then <code>newScroll</code> = <code>newScroll</code> + 0.5 * (<code>maxScroll</code> - <code>newScroll</code>) repeat with n = 1 to dt <code>newScroll</code> = <code>newScroll</code> + 0.05 * (<code>glistObject.fineScrollPos</code> - <code>newScroll</code>) end repeat <code>scrollSpeed</code> = 1.0 * (<code>newScroll</code> - <code>glistObject.fineScrollPos</code>) / dt setFineScroll <code>glistObject</code>, <code>newScroll</code> draw <code>glistObject</code> end if end if on setFineScroll me, scr <code>fineScrollPos</code> = scr <code>scrollPos</code> = integer(<code>fineScrollPos</code>) end </pre> |

| | | |
|--|--|--|
| | <p>[first vertical position of finger]</p> <p>The “TmouseDrag” function then adjusted the new scrolling position to make the scrolling appear smoother, based on weighted averaging of historical position and velocity, arriving at an adjusted value (“SetFineScroll” setting fineScrollPos”).</p> <p>It then called the “draw” function (“draw gListObject”).</p> <p>The “draw” function, discussed above, redrew the electronic document as having scrolled in the direction of movement, based on the new value of “fineScrollPos”. If the scrolling position changed sufficiently to increment the earliest and/or latest visible items on the list, the function displayed a second, different portion of the list.</p> | |
| <p>(d) in response to an edge of the electronic document being reached while</p> | <p>The value of “listLength” (defined above) defined both the top and bottom edges of the list. The top edge of the list was reached if the list scrolled down until the</p> | <p>$listLength = topSpace + pCurrentStrip.myLength + bottomSpace$</p> <hr/> |

| | | |
|---|--|---|
| <p>translating the electronic document in the first direction while the object is still detected on or near the touch screen display:</p> <p>(d1) displaying an area beyond the edge of the document, and</p> | <p>scrolling position (“fineScrollPos”) dropped to zero. The bottom edge of the list was reached if the list scrolled up until its scrolling position (“fineScrollPos”) rose to a value equal to the length of the list (“listLength”).</p> <p>As described above, the “TmouseDrag” function set a modified scrolling position (“fineScrollPos”) while the object (finger) was still detected, and then called the “draw” function.</p> <p>The “draw” function in the Letter Group script redrew the document on the display window based on the new scrolling position.</p> <p>The “draw” function in the Strip Object script, based on the current scrolling position (“scrollPos”) and size of the displayed list on the screen (“r = duplicate (mySuper.pDrawBuffer.rect)”), filled in any visible area above the top edge of the list with a color (“kLightBGcol”).</p> <p>The function also compared the</p> | <pre> on draw me, inRect, scrollPos y = scrollPos if (y > 0) then r = duplicate(mySuper.pDrawBuffer.rect) r.bottom = y fill mySuper.pDrawBuffer, r, kLightBGcol end if startN = 0 repeat with n = 1 to grpCount grp = myLetterGroups[n] if (y + grp.myLength > inRect.top) then startN = n exit repeat else y = y + grp.myLength end if end repeat inRectFilled = FALSE </pre> |
|---|--|---|

length of the displayed items of the list with the length of the display to see whether any area beyond the bottom edge was visible, and if so (“if (not inRectFilled)”), it filled in any visible area below the bottom edge of the list with the same color (“kLightBGcol”) as it would use to fill a visible area beyond the top edge of the list.

In response to the top edge being reached, then based on the current scrolling position (“fineScroll”) and taking account of the top and bottom border areas of the list, “startN” would remain at a value of 1 (meaning that the first item on the list is visible), and less and less screen area would be available below the first item so less and less of the rest of the list would be displayed (“if (y > inRect.bottom) then exit repeat”). The visible items and top border area would then be displayed in a new position. The first item would be visible, the top edge of the list’s margin would be visible above that, and an area beyond the edge of the list would be visible

```
-- draw names
c = count(myItems)
if (c > 0) then
  startN = integer(1.0 * (inRect.top - (yy + myHeaderH)) / myItemHeight + 0.5)
  if (startN < 1) then startN = 1
  if (startN > c) then startN = c

  x = mySuper.planeStart

  repeat with n = startN to c
    y = (yy + myHeaderH) + (n - 1) * myItemHeight

    if (y > inRect.bottom) then exit repeat

  -- top line
  --fill context, rect(0, y, inRect.width, y + 1), rgb(240, 240, 240)

  -- name tag
  nameID = myItems[n]
  nameTag = mySuper.planeBitmaps[nameID]
  nameRect = nameTag.rect
  cof = (myItemHeight - nameRect.height) / 2 --- 2

  if (nameID = mySuper.selectedID) then
    fill context, rect(0, y, inRect.width, y + myItemHeight), rgb( 0, 82, 233 )
    copyPixels context, nameTag, nameRect.offset(x, y + cof), nameRect, [BgColor: 0]
  else
    copyPixels context, nameTag, nameRect.offset(x, y + cof), nameRect, [BgColor: 255]
  -- bottom line
  fill context, rect(0, y + myItemHeight - 1, inRect.width, y + myItemHeight), rgb(
  240, 240, 240 )
end if
```

| | | |
|---|---|--|
| | <p>between the top edge of the list and the top edge of the touch screen display. The analogous behavior would occur at the bottom of the list if the bottom edge was reached.</p> | |
| <p>(d2) displaying a third portion of the electronic document, wherein the third portion is smaller than the first portion; and</p> | <p>The change of scroll position would result in a third portion of the list being displayed, and the downward increment of the number of the last visible item in response to the top edge of the list being reached would result in fewer items on the list being displayed in this third portion than in the first portion.</p> <p>Similarly, in response to the bottom edge being reached, then, based on the current scrolling position (“fineScrollPos”) and taking account of the top and bottom border areas of the list, the earliest visible item on the list (“startN” would be recalculated to a higher number (“startN = integer(1.0 * (inRect.top - (yy + myHeaderH)) / myItemHeight + 0.5)”). The items below it would then be drawn until no more items were left (n = c). The last item would be visible, the bottom edge of the list would be visible</p> | <pre> -- draw names c = count(myItems) if (c > 0) then startN = integer(1.0 * (inRect.top - (yy + myHeaderH)) / myItemHeight + 0.5) if (startN < 1) then startN = 1 if (startN > c) then startN = c x = mySuper.phoneXstart repeat with n = startN to c y = (yy + myHeaderH) + (n - 1) * myItemHeight if (y > inRect.bottom) then exit repeat -- top line --fill context, rect(0, y, inRect.width, y + 1), rgb(240, 240, 240) -- name tag nameID = myItems[n] nameTag = mySuper.phoneBitmaps[nameID] nameRect = nameTag.rect cof = (myItemHeight - nameRect.height) / 2 ---- 2 if (nameID = mySuper.selectedID) then fill context, rect(0, y, inRect.width, y + myItemHeight), rgb(0, 22, 233) copyPixels context, nameTag, nameRect.offset(x, y + cof), nameRect, [backgroundColor: 0] else copyPixels context, nameTag, nameRect.offset(x, y + cof), nameRect, [backgroundColor: 255] -- bottom line fill context, rect(0, y + myItemHeight - 1, inRect.width, y + myItemHeight), rgb(240, 240, 240) end if </pre> |

| | | |
|--|--|--|
| | <p>below that, and an area beyond the edge of the list would be visible between the bottom edge of the list and the bottom edge of the touch screen display. The change of scroll position would result in a third portion of the list being displayed, and the upward increment of "startN" in response to the bottom edge of the list being reached would result in fewer items on the list being displayed in this third portion than in the first portion.</p> <p>The exception, in this demonstration code, would have been if the list had too few items to fill the screen (i.e., if startN = 1 <u>and</u> the displayable list below it stopped before it got to "inRect.bottom"). In that case, all the names on the list would have been displayable on the display window at the same time, and reaching the top edge of the list, for example, would not have displayed a smaller portion of the list unless the list scrolled sufficiently that the bottom edge of the list happened to leave the bottom of the display, or vice versa. However, in this case</p> | |
|--|--|--|

| | | |
|--|--|--|
| | <p>there would be no reason to scroll the list, since it would be all visible.</p> | |
| <p>(e) in response to detecting that the object is no longer on or near the touch screen display, translating the electronic document in a second direction until the area beyond the edge of the electronic document is no longer displayed to display a fourth portion of the electronic document, wherein the fourth portion is different</p> | <p>The “exitFrame” function was called in a system call several times per second. (Ording Decl. ¶ 45)</p> <p>The “exitFrame” function detected whether no finger was detected any longer (“if (not dragging)”).</p> <p>If “dragging” was set to FALSE, then in response the “exitFrame” function detected whether an edge of the list had been reached (i.e., was visible on screen).</p> <p>When “scrollTriggered” was TRUE (i.e., during scrolling by a detected finger), the “TmouseDrag” function had set newScroll as the latest scrolling position based on the quantity of detected movement, and maxScroll as the total vertical length of the list minus the total vertical length of the screen.</p> | <pre> on TmouseDrag me if (scrollTriggered) then dt = currentTime - lastTouchTime if (dt > 0) then newScroll = startScrollPos - (currentTouchPos.locY - touchPosAtStart.locY) * 1.0 maxScroll = gListObject.listLength - gListObject.pViewHeight </pre> <hr/> <pre> on exitFrame me currentUpdateTime = the milliseconds dt = currentUpdateTime - lastUpdateTime if (dt > 0) then </pre> |

| | | |
|--------------------------------|--|---|
| <p>from the first portion.</p> | <p>If “newScroll < 0” the top edge of the list had been reached.</p> <p>If “newScroll > maxScroll” the bottom edge of the list had been reached.</p> <p>If an edge of the list had been reached, then, with each successive run of “exitFrame” the exact scrolling position (“newScroll”) was modified to reduce the absolute distance between the scrolling position and the edge that had been reached by about one one-hundredth (e.g., if the top edge was reached because the scrolling position was negative, “newScroll = newScroll + 0.01 * (0 - newScroll)”). This successive small incrementing of the scrolling position to remove the area beyond the edge of the list from the display would only occur if an edge had been reached (“if(not dragging)”), <i>i.e.</i>, when an area beyond the edge was visible.</p> <p>Each time the display was redrawn by the “draw” script in</p> | <pre> if (not dragging) then newScroll = gListObject.fineScrollPos maxScroll = gListObject.listLength - gListObject.pViewHeight repeat with n = 1 to dt scrollSpeed = 0.998 * scrollSpeed newScroll = newScroll + scrollSpeed if (newScroll < 0) then newScroll = newScroll + 0.01 * (0 - newScroll) scrollSpeed = 0.990 * scrollSpeed end if if (newScroll > maxScroll) then newScroll = newScroll + 0.01 * (maxScroll - newScroll) scrollSpeed = 0.990 * scrollSpeed end if end repeat setFineScroll gListObject, newScroll draw gListObject end if end if lastUpdateTime = currentUpdateTime end on setFineScroll me, scr fineScrollPos = scr scrollPos = integer(fineScrollPos) end on draw me draw pCurrentStrip, rect(0, 0, pViewWidth, pViewHeight), - scrollPos + topSpace </pre> |
|--------------------------------|--|---|

| | | |
|--|--|--|
| | <p>the list object script, the scroll position was revised based on an integer value of newscroll by calling the “setFineScroll” function with scrollPos as the “scr” variable. (“scrollPos = integer(fineScrollPos),” then invoking “draw” using scrollPos). When the value of “newScroll” dropped low enough, scrolling stopped and the list was redrawn so that the area beyond that edge was no longer visible.</p> <p>When the area beyond the document is no longer displayed, a fourth portion of the document is displayed, which is different from the first portion by virtue of the fact that it was displayed after performing a scroll.</p> | |
| <p>2. The computer-implemented method of claim 1, wherein the first portion of the electronic document, the second portion of the electronic document, the third portion of the electronic document, and the fourth portion of the</p> | <p>See claim 1 above.</p> <p>The same magnification was maintained throughout the scrolling. (Ording ¶ 46)</p> | |

| | | |
|--|---|---|
| electronic document are displayed at the same magnification. | | |
| 3. The computer-implemented method of claim 1, wherein the movement of the object is on the touch screen display. | See claim 1 above. In my demonstration, the finger was moved on the touch screen display of the device to effect scrolling. (Ording Decl. ¶ 23) In fact, the function detecting the movement was named "TmouseDrag," referred to the starting touch position ("touchPosAtStart") and last touch position ("lastTouchPos") by similarly suggestive names. | <pre> if (abs(currentTouchPos.locV - touchPosAtStart.locV) > 10) then scrollTriggered = TRUE touchPosAtStart = lastTouchPos glistObject.selectedID = 0 end if </pre> |
| 4. The computer-implemented method of claim 1, wherein the object is a finger. | See claim 1 above. In the demonstration, a finger was used as the object. (Ording ¶ 23) | <pre> event script (Internal) --global multiFingerObject, scanOffset </pre> |
| 5. The computer-implemented method of claim 1, wherein the first direction is a vertical direction, a horizontal direction, or a diagonal direction. | See claim 1 above. The scrolling of the list was upward and downward. The new scrolling position was based on the change in vertical ("v") position. | <pre> if (scrollTriggered) then dt = currentTouchTime - lastTouchTime if (dt > 0) then newScroll = startScrollPos - (currentTouchPos.locV - touchPosAtStart.locV) * 1.0 end if end if </pre> |
| 6. The computer-implemented method of claim 1, wherein the electronic document is | There is no rejection of claim 6 based on the '975 reference. | |

| | | |
|---|---|---|
| a web page. | | |
| 7. The computer-implemented method of claim 1, wherein the electronic document is a digital image. | There is no rejection of claim 6 based on the '975 reference. | |
| 8. The computer-implemented method of claim 1, wherein the electronic document is a word processing, spreadsheet, email or presentation document. | There is no rejection of claim 6 based on the '975 reference. | |
| 9. The computer-implemented method of claim 1, wherein the electronic document includes a list of items. | See claim 1 above. The device displayed a list of defined length scrollable up and down on the screen. | <pre> topSpace = 50 bottomSpace = 50 pItemHeight = 31 --32 * * * listLength = topSpace + pCurrentStrip.myLength + bottomSpace </pre> |
| 10. The computer-implemented method of claim 1, wherein the second direction is opposite the first direction. | See claim 1 above. The list could be scrolled up and down. | <pre> if (scrollTriggered) then dt = currentTime - lastTouchTime if (dt > 0) then newScroll = startScrollPos - (currentTouchPos.locV - touchPosAtStart.locV) * 1.0 </pre> |
| 11. The computer-implemented method of claim 1, wherein translating in the first direction prior to reaching an edge of the document has an | See claim 1 above. A speed of scrolling was defined by the difference between the object's positions at two different times. | <pre> if (scrollTriggered) then dt = currentTime - lastTouchTime if (dt > 0) then newScroll = startScrollPos - (currentTouchPos.locV - touchPosAtStart.locV) * 1.0 </pre> |

| | | |
|--|---|---|
| <p>associated speed of translation that corresponds to a speed of movement of the object.</p> | | <pre>dt = currentTime - lastTouchTime if (dt > 0) then repeat with k = 1 to dt fineScroll = (20.0 * fineScroll + 1.0 * newScroll) / (20.0 + 1.0) end repeat newSpeed = 1.0 * (currentFineScroll - fineScroll) / dt add speedList, newSpeed</pre> |
| <p>12. The computer-implemented method of claim 1, wherein translating in the first direction is in accordance with a simulation of an equation of motion having friction.</p> | <p>See claim 1 above.</p> <p>The “exitFrame” function determined whether an edge of the list had been tentatively reached before adjustments (such as damping) were calculated.</p> <p>If “NewScroll > 0” the top edge of the list has been reached.</p> <p>If “NewScroll > listLength – viewHeight” the bottom edge of the list has been reached.</p> <p>If either edge of the list is detected, the scrolling was damped by being effectively halved while scrolling in the first direction. Thus, scrolling in the first direction appears as if it is meeting friction or resistance.</p> | <pre>if (newScroll < 0) then newScroll = newScroll + 0.5 * (0 - newScroll) if (newScroll > maxScroll) then newScroll = newScroll + 0.5 * (maxScroll - newScroll) repeat with n = 1 to dt newScroll = newScroll + 0.05 * (glistObject.fineScrollPos - newScroll) end repeat</pre> |
| <p>13. The computer-implemented method of claim 1, wherein the</p> | <p>See claim 1 above.</p> <p>The “draw” function in the Strip</p> | |

| | | |
|---|---|--|
| <p>area beyond the edge of the document is black, gray, a solid color, or white.</p> | <p>Object script, based on the current scrolling position ("scrollPos") and size of the displayed list on the screen ("r = duplicate (mySuper.pDrawBuffer.rect)"), filled in any visible area above the top edge of the list with a blue color ("kLightBGcol"). The function then compared the length of the displayed items of the list with the length of the display to see whether any area beyond the bottom edge was visible, and if so ("if (not inRectFilled)"), it filled in any visible area below the bottom edge of the list with the same blue color ("kLightBGcol") as it would use to fill a visible area beyond the top edge of the list.</p> | <pre> on draw me, inRect, scrollPos y = scrollPos if (y > 0) then r = duplicate(mySuper.pDrawBuffer.rect) r.bottom = y fill mySuper.pDrawBuffer, r, kLightBGcol end if if (startN > 0) then repeat with n = startN to grpCount grp = myLetterGroups[n] draw grp, inRect, y y = y + grp.myLength if (y > inRect.bottom) then inRectFilled = TRUE exit repeat end if end repeat end if if (not inRectFilled) then if (y < inRect.bottom) then r = duplicate(mySuper.pDrawBuffer.rect) r.top = y fill mySuper.pDrawBuffer, r, kLightBGcol end if end if </pre> |
| <p>14. The computer-implemented method of claim 1, wherein the area beyond the edge of the document is visually distinct from the document.</p> | <p>There is no rejection of claim 6 based on the '975 reference.</p> | |

| | | |
|---|--|--|
| <p>15. The computer-implemented method of claim 1, wherein translating the document in the second direction is a damped motion.</p> | <p>See claim 1 above.</p> <p>If an edge of the list had been reached, then, with each successive run of “exitFrame” the exact scrolling position (“newScroll”) was modified to reduce the absolute distance between the scrolling position and the edge that had been reached by about one one-hundredth (e.g., if the top edge was reached because the scrolling position was negative, “newScroll = newScroll + 0.01 * (0 - newScroll)”). This successive small incrementing of the scrolling position to remove the area beyond the edge of the list from the display would only occur if an edge had been reached (“if(not dragging)”), <i>i.e.</i>, when an area beyond the edge was visible.</p> <p>Each time the display was redrawn by the “draw” script in the list object script, the scroll position was revised based on an integer value of newscroll by calling the “setFineScroll” function with scrollPos as the “scr” variable. (“scrollPos =</p> | |
|---|--|--|

| | | |
|--|--|---|
| | <p>integer(fineScrollPos),” then invoking “draw” using scrollPos). When the value of “newScroll” dropped low enough, scrolling stopped and the list was redrawn so that the area beyond that edge was no longer visible.</p> | |
| <p>16. The computer-implemented method of claim 1, wherein changing from translating in the first direction to translating in the second direction until the area beyond the edge of the document is no longer displayed makes the edge of the electronic document appear to be elastically attached to an edge of the touch screen display or to an edge displayed on the touch screen display.</p> | <p>See claim 1 and 15 above.</p> <p>When these UI functions operated in the demonstration, it appeared as if the edges of the list were elastically attached, as if by a rubber band, to the edge of the display, as if the edge of the list would start to progressively resist going beyond the edge of the touch screen display, and then would return the other direction with liftoff and slow to a stop exactly touching the edge of the touch screen display. (Ording ¶ 27)</p> | <pre> if (newScroll < 0) then newScroll = newScroll + 0.5 * (0 - newScroll) if (newScroll > maxScroll) then newScroll = newScroll + 0.5 * (maxScroll - newScroll) repeat with n = 1 to dt newScroll = newScroll + 0.05 * (glistObject.fineScrollPos - newScroll) end repeat if (not dragging) then newScroll = glistObject.fineScrollPos maxScroll = glistObject.listlength - glistObject.pViewHeight repeat with n = 1 to dt scrollSpeed = 0.998 * scrollSpeed newScroll = newScroll + scrollSpeed if (newScroll < 0) then newScroll = newScroll + 0.01 * (0 - newScroll) scrollSpeed = 0.990 * scrollSpeed end if if (newScroll > maxScroll) then newScroll = newScroll + 0.01 * (maxScroll - newScroll) scrollSpeed = 0.990 * scrollSpeed end if end repeat setFineScroll glistObject, newScroll draw glistObject end if end if lastUpdateTime = currentUpdateTime end </pre> |
| <p>17. The computer-implemented method of claim 1, wherein translating in the first</p> | <p>See claim 1 above.</p> <p>The “exitFrame” function determined whether an edge of</p> | <pre> if (newScroll < 0) then newScroll = (1.0 * newScroll + 0) / (2.0) if (newScroll > listlength - viewheight) then newScroll = (1.0 * newScroll + (listlength - viewheight)) / (2.0) </pre> |

| | | |
|--|--|--|
| <p>direction prior to reaching the edge of the electronic document has a first associated translating distance that corresponds to a distance of movement of the object prior to reaching the edge of the electronic document; and wherein displaying an area beyond the edge of the electronic document comprises translating the electronic document in the first direction for a second associated translating distance, wherein the second associated translating distance is less than a distance of movement of the object after reaching the edge of the electronic document.</p> | <p>the list had been tentatively reached before adjustments (such as damping) were calculated.</p> <p>If "NewScroll > 0" the top edge of the list has been reached.</p> <p>If "NewScroll > listLength - viewHeight" the bottom edge of the list has been reached.</p> <p>If either edge of the list is detected, the scrolling was damped by being effectively halved while scrolling in the first direction. Thus, scrolling in the first direction appeared as if it was meeting friction or resistance. (Ordering ¶ 27)</p> | |
| <p>18. The computer-implemented method of claim 1, wherein translating in the first</p> | <p>See claim 1 above.</p> <p>The "exitFrame" function determined whether an edge of</p> | |

| | | |
|--|---|---|
| <p>direction prior to reaching the edge of the electronic document has a first associated translating speed that corresponds to a speed of movement of the object, and wherein displaying an area beyond the electronic document comprises translating the electronic document in the first direction at a second associated translating speed, wherein the second associated translating speed is slower than the first associated translating speed.</p> | <p>the list had been tentatively reached before adjustments (such as damping) were calculated.</p> <p>If “NewScroll > 0” the top edge of the list has been reached.</p> <p>If “NewScroll > listLength – viewHeight” the bottom edge of the list has been reached.</p> <p>If either edge of the list is detected, the scrolling was damped by being effectively halved while scrolling in the first direction. Thus, scrolling in the first direction appears as if it is meeting friction or resistance.</p> <p>The scrolling speed is defined by the distance scrolled in each interval. Furthermore, the damping of the scrolling distances just described reduces the scrolling speed apparent to the viewer. (Ordning ¶ 27)</p> | <pre> if (not dragging) then newScroll = glistObject.fineScrollPos maxScroll = glistObject.listlength - glistObject.viewHeight repeat with n = 1 to dt scrollSpeed = 0.998 * scrollSpeed newScroll = newScroll + scrollSpeed if (newScroll < 0) then newScroll = newScroll + 0.01 * (0 - newScroll) scrollSpeed = 0.998 * scrollSpeed end if if (newScroll > maxScroll) then newScroll = newScroll + 0.01 * (maxScroll - newScroll) scrollSpeed = 0.998 * scrollSpeed end if end repeat setFineScroll glistObject, newScroll draw glistObject end if end if lastUpdateTime = currentTime end </pre> |
| <p>19. A device, comprising:</p> | <p>See claim 1, preamble.</p> | |
| <p>(a) a touch screen display;</p> | <p>See claim 1, element (a).</p> <p>The computer had a touch</p> | |

| | | |
|--|---|--|
| | screen display. | |
| (b) one or more processors; | See claim 1, element (a). The computer had processors including a CPU that were used to compile and run the code on the computer. (Ordning ¶ 6) | |
| (c) memory; and | See claim 1, element (a) The computer had memory that stored the scripts. (Ordning ¶ 33) | |
| (d) one or more programs, wherein the one or more programs are stored in the memory and configured to be executed by the one or more processors, the programs including: | See claim 1, element (a). The computer had memory that stored the scripts, which were run by the CPU. (Ordning ¶¶ 28, 35) The scripts were Director files that, when run by Director, instructed the computer to run the UI for the scrollable contact list on the touch screen display. (Ordning ¶ 20) | |
| (e) instructions for displaying a first portion of an electronic document; | See claim 1, element (b). | |
| (f) instructions for detecting a movement of an object on or near | See claim 1, element (c). | |

| | | |
|---|---|--|
| the touch screen display; | | |
| (f1) instructions for translating the electronic document displayed on the touch screen display in a first direction to display a second portion of the electronic document, wherein the second portion is different from the first portion, in response to detecting the movement; | See claim 1, element (c1). | |
| (g) instructions for displaying an area beyond an edge of the electronic document and displaying a third portion of the electronic document, wherein the third portion is smaller | See claim 1, elements (d), (d1) and (d2). | |

| | | |
|---|----------------------------------|--|
| <p>than the first portion, in response to the edge of the electronic document being reached while translating the electronic document in the first direction while the object is still detected on or near the touch screen display; and</p> | | |
| <p>(h) instructions for translating the electronic document in a second direction until the area beyond the edge of the electronic document is no longer displayed to display a fourth portion of the electronic document, wherein the fourth portion is different from the</p> | <p>See claim 1, element (e).</p> | |

| | | |
|---|--|--|
| first portion, in response to detecting that the object is no longer on or near the touch screen display. | | |
| 20. A computer readable storage medium having stored therein instructions, which when executed by a device with a touch screen display, cause the device to: | See claim 1, element (a) and claim 19, elements (c) and (d). | |
| (a) display a first portion of an electronic document; | See claim 1, element (b). | |
| (b) detect a movement of an object on or near the touch screen display; | See claim 1, element (c). | |
| (b1) translate the electronic document displayed on the touch screen display in a first direction to display a second portion of the electronic document, wherein the second portion is different from the first portion, | See claim 1, element (c1). | |

| | | |
|---|--|--|
| in response to detecting the movement; | | |
| (c) display an area beyond an edge of the electronic document and display a third portion of the electronic document, wherein the third portion is smaller than the first portion, if the edge of the electronic document is reached while translating the electronic document in the first direction while the object is still detected on or near the touch screen display; and | See claim 1, element (d), (d1) and (d2). | |
| (d) translate the electronic document in a second direction until the area beyond the edge of the electronic document is no longer displayed to display a fourth portion of the electronic document, wherein the fourth portion is different | See claim 1, element (e). | |

| | | |
|---|--|--|
| from the first portion, in response to detecting that the object is no longer on or near the touch screen display. | | |
|---|--|--|

IN THE UNITED STATES PATENT AND TRADEMARK OFFICE

In re: Reexam of U.S. Patent No. 7,469,381 B2

Control No. 90/012,304

Filed: May 23, 2012

For: **LIST SCROLLING AND
DOCUMENT TRANSLATION,
SCALING, AND ROTATION ON A
TOUCH-SCREEN DISPLAY**

Confirmation No.: 4807

Art Unit: 3992

Examiner: Bonshock, Dennis G

Atty. Docket:

P4304USREX2/120730-002US

Mail Stop *Ex Parte* Reexam
Central Reexamination Unit
Commissioner for Patents
United States Patent and Trademark Office
P.O. Box 1450
Alexandria, VA 22313-1450

January 15, 2013

Sir:

Transmitted herewith for appropriate action are the following documents:

1. Patent Owner's Response to Non-Final Office Action with Exhibit 1
2. Declaration Under 35 U.S.C § 132 of Prof. Brad A. Myers, Ph.D. with Exhibit 1
3. Declaration of Bas Ording Under 37 CFR § 1.131 with Exhibits A-I
4. Declaration of Greg Christie Under 37 CFR § 1.131 with Exhibit A
5. Certificate of Service

The U.S. Patent and Trademark Office is hereby authorized to charge any fee deficiency to Goldberg, Lowenstein & Weatherwax LLP Deposit Account No. 50-5927.

Very truly yours,

/Kenneth J. Weatherwax/

Kenneth J. Weatherwax, Reg. No. 54,528
Goldberg, Lowenstein & Weatherwax LLP
11400 W. Olympic Blvd., Suite 400
Los Angeles, CA 90064

Electronic Acknowledgement Receipt

| | |
|---|--|
| EFS ID: | 14705854 |
| Application Number: | 90012304 |
| International Application Number: | |
| Confirmation Number: | 4807 |
| Title of Invention: | LIST SCROLLING AND DOCUMENT TRANSLATION, SCALING, AND ROTATION ON A TOUCH-SCREEN DISPLAY |
| First Named Inventor/Applicant Name: | 7,469,381 |
| Customer Number: | 108491 |
| Filer: | Kenneth James Weatherwax |
| Filer Authorized By: | |
| Attorney Docket Number: | P4304USREX2/120730-002US |
| Receipt Date: | 15-JAN-2013 |
| Filing Date: | 23-MAY-2012 |
| Time Stamp: | 16:50:45 |
| Application Type: | Reexam (Third Party) |

Payment information:

| | |
|------------------------|----|
| Submitted with Payment | no |
|------------------------|----|

File Listing:

| Document Number | Document Description | File Name | File Size(Bytes)/ Message Digest | Multi Part /.zip | Pages (if appl.) |
|-----------------|--|--|--|------------------|------------------|
| 1 | Response after non-final action-owner timely | Declaration131_of_Ording_DeclR_EFS.pdf | 707942 b3f1c5cbeffb6632f497b9c9337c5539 | no | 11 |

Warnings:**Information:**

| | | | | | |
|---------------------|--|----------------------------------|--|----|----|
| 2 | Response after non-final action-owner timely | Declaration131_of_Ording_ExA.pdf | 380565 93d312a0ebeb8c9d66b87ddb8784273123a3923f | no | 4 |
| Warnings: | | | | | |
| Information: | | | | | |
| 3 | Response after non-final action-owner timely | Declaration131_of_Ording_ExB.pdf | 107835 7fc8eb4848880e5983e293f962f609daae65183a | no | 11 |
| Warnings: | | | | | |
| Information: | | | | | |
| 4 | Response after non-final action-owner timely | Declaration131_of_Ording_Exc.pdf | 53431 0619c7264ed882d73c6e7bd8323194b125a70249 | no | 2 |
| Warnings: | | | | | |
| Information: | | | | | |
| 5 | Response after non-final action-owner timely | Declaration131_of_Ording_ExD.pdf | 91828 ffc65212621dea1c3c40b98300450a33c6d68817 | no | 2 |
| Warnings: | | | | | |
| Information: | | | | | |
| 6 | Response after non-final action-owner timely | Declaration131_of_Ording_ExE.pdf | 103986 fa0ca5a86a9384cb711f2ef3dfbb0a7d6df6c9f8 | no | 2 |
| Warnings: | | | | | |
| Information: | | | | | |
| 7 | Response after non-final action-owner timely | Declaration131_of_Ording_ExF.pdf | 153381 3e4943cccb21e35fb667dfe954fdff3c7392b6e1 | no | 26 |
| Warnings: | | | | | |
| Information: | | | | | |
| 8 | Response after non-final action-owner timely | Declaration131_of_Ording_ExG.pdf | 58793 0ffb7bc13f5142260d46877b4d04e1e0bde97160 | no | 2 |
| Warnings: | | | | | |
| Information: | | | | | |
| 9 | Response after non-final action-owner timely | Declaration131_of_Ording_ExH.pdf | 90022 4e1c76b7bbf1bc6e55622f178d5b91d92cfbc3f9 | no | 2 |
| Warnings: | | | | | |
| Information: | | | | | |
| 10 | Response after non-final action-owner timely | Declaration131_of_Ording_ExI.pdf | 256914 a88cd6aed3ab11852bca1ff2ddf6fd510e2f7f | no | 2 |
| Warnings: | | | | | |
| Information: | | | | | |

| | | | | | |
|--|--|--|---|----|----|
| 11 | Response after non-final action-owner timely | 381_131_GregChristie_EFS.pdf | 1330280 fb1ee1f41d680168cb13bc2afd631f90f9252c4a | no | 4 |
| Warnings: | | | | | |
| Information: | | | | | |
| 12 | Response after non-final action-owner timely | 381_131_GregChristie_Ex_A.pdf | 379496 adb0ed1227e8a84edc14c7948c9c378a845631ed | no | 4 |
| Warnings: | | | | | |
| Information: | | | | | |
| 13 | Response after non-final action-owner timely | 381_132_Meyer_CV_Ex1.pdf | 1110069 a0a225b6b00d0da64c2022ae83ebd1ce11672351 | no | 50 |
| Warnings: | | | | | |
| Information: | | | | | |
| 14 | Response after non-final action-owner timely | 381_132_Meyer_Decl_EFS.pdf | 2490160 3e07d002b70ae272bc43652a52f5e2a5805b2eb6 | no | 51 |
| Warnings: | | | | | |
| Information: | | | | | |
| 15 | Reexam Certificate of Service | 381_COS_Response_to_OA1_and_declarations_EFS.pdf | 78639 6bbe38bd2a829a2ada2fd12605c574b6eabed0cc2 | no | 1 |
| Warnings: | | | | | |
| Information: | | | | | |
| 16 | Response after non-final action-owner timely | 381_Response_FINAL_EFS.pdf | 3396790 f791246b3fb7ab00e9537fd01a81e1fef4ea0a95 | no | 70 |
| Warnings: | | | | | |
| Information: | | | | | |
| 17 | Response after non-final action-owner timely | Response_Exhibit1_EFS.pdf | 1548358 40743a5e112680df1ea99c3e9e235aebd90a14ee | no | 30 |
| Warnings: | | | | | |
| The page size in the PDF is too large. The pages should be 8.5 x 11 or A4. If this PDF is submitted, the pages will be resized upon entry into the Image File Wrapper and may affect subsequent processing | | | | | |
| Information: | | | | | |
| 18 | Reexam Miscellaneous Incoming Letter | 381_transmittalletter_Response_to_OA1_and_declarations_EFS.pdf | 73841 07a46bb73f5e909d5e4a33a431a7f93e7d42a5f5 | no | 1 |
| Warnings: | | | | | |
| Information: | | | | | |
| Total Files Size (in bytes): | | | 12412330 | | |

This Acknowledgement Receipt evidences receipt on the noted date by the USPTO of the indicated documents, characterized by the applicant, and including page counts, where applicable. It serves as evidence of receipt similar to a Post Card, as described in MPEP 503.

New Applications Under 35 U.S.C. 111

If a new application is being filed and the application includes the necessary components for a filing date (see 37 CFR 1.53(b)-(d) and MPEP 506), a Filing Receipt (37 CFR 1.54) will be issued in due course and the date shown on this Acknowledgement Receipt will establish the filing date of the application.

National Stage of an International Application under 35 U.S.C. 371

If a timely submission to enter the national stage of an international application is compliant with the conditions of 35 U.S.C. 371 and other applicable requirements a Form PCT/DO/EO/903 indicating acceptance of the application as a national stage submission under 35 U.S.C. 371 will be issued in addition to the Filing Receipt, in due course.

New International Application Filed with the USPTO as a Receiving Office

If a new international application is being filed and the international application includes the necessary components for an international filing date (see PCT Article 11 and MPEP 1810), a Notification of the International Application Number and of the International Filing Date (Form PCT/RO/105) will be issued in due course, subject to prescriptions concerning national security, and the date shown on this Acknowledgement Receipt will establish the international filing date of the application.

Electronic Acknowledgement Receipt

| | |
|---|--|
| EFS ID: | 14708622 |
| Application Number: | 90012304 |
| International Application Number: | |
| Confirmation Number: | 4807 |
| Title of Invention: | LIST SCROLLING AND DOCUMENT TRANSLATION, SCALING, AND ROTATION ON A TOUCH-SCREEN DISPLAY |
| First Named Inventor/Applicant Name: | 7,469,381 |
| Customer Number: | 108491 |
| Filer: | Kenneth James Weatherwax/Qing ye |
| Filer Authorized By: | Kenneth James Weatherwax |
| Attorney Docket Number: | P4304USREX2/120730-002US |
| Receipt Date: | 15-JAN-2013 |
| Filing Date: | 23-MAY-2012 |
| Time Stamp: | 19:15:46 |
| Application Type: | Reexam (Third Party) |

Payment information:

| | |
|------------------------|----|
| Submitted with Payment | no |
|------------------------|----|

File Listing:

| Document Number | Document Description | File Name | File Size(Bytes)/ Message Digest | Multi Part /.zip | Pages (if appl.) |
|-----------------|----------------------|-----------------------------|--|------------------|------------------|
| 1 | Foreign Reference | FP35_JPA_H11-327733_EFS.pdf | 324701 ae5815216450a567f55de8a33dbba3590581677a | no | 10 |

Warnings:**Information:**

| | | | | | |
|---------------------|-------------------|--|---|----|----|
| 2 | Foreign Reference | FP36_JPA_H10-240220_EFS.pdf | 621438 dbfb622eccea86ff0d9eff59b4464bd3204b07b3 | no | 26 |
| Warnings: | | | | | |
| Information: | | | | | |
| 3 | Foreign Reference | FP37_JP2003344059_Ab_EFS.pdf | 89415 0c33602fbc621d6f0cf1da0cda937ac03be6e307 | no | 2 |
| Warnings: | | | | | |
| Information: | | | | | |
| 4 | Foreign Reference | FP37_JP2003344059_MachineTrans.pdf | 317454 4903c65da5f73e327c49803f8890dbaa672bff5 | no | 16 |
| Warnings: | | | | | |
| Information: | | | | | |
| 5 | Foreign Reference | FP37_JP2003344059A_EFS.pdf | 700260 7032b8128bc47f19dc75706cc60577053a5fba50 | no | 9 |
| Warnings: | | | | | |
| Information: | | | | | |
| 6 | Foreign Reference | FP38_JP2001290585_MachineTrans_EFS.pdf | 1390477 bb302522db92c4d9e12ede6a571c9b5ab271a18d | no | 71 |
| Warnings: | | | | | |
| Information: | | | | | |
| 7 | Foreign Reference | FP38_JP2001290585A_EFS.pdf | 4365571 8259822e16617e5d75adb426a27b9553eaa34906 | no | 66 |
| Warnings: | | | | | |
| Information: | | | | | |
| 8 | Foreign Reference | FP39_JP2003288151_Ab_EFS.pdf | 96978 d83b305a6841a66621a445c52f6c574a334756e5 | no | 2 |
| Warnings: | | | | | |
| Information: | | | | | |
| 9 | Foreign Reference | FP39_JP2003288151_MachineTrans_EFS.pdf | 350552 f9c4340869e7ce05053f1246049bdbbbae9d7a9 | no | 18 |
| Warnings: | | | | | |
| Information: | | | | | |
| 10 | Foreign Reference | FP40_JP2003140802_Ab_EFS.pdf | 89427 5c98caf98c069d0e8c3983e7c2249ab506de18d6 | no | 2 |
| Warnings: | | | | | |
| Information: | | | | | |

| | | | | | |
|---------------------|-------------------|---|---|----|----|
| 11 | Foreign Reference | FP40_JP2003140802_MachineTrans_EFS.pdf | 541003 019e563e4b30fd7395e5300929b480707a7681ec | no | 27 |
| Warnings: | | | | | |
| Information: | | | | | |
| 12 | Foreign Reference | FP40_JP2003140802A_EFS.pdf | 2950546 33a2f838fe8045f9215530695784b06fae0dbeba | no | 63 |
| Warnings: | | | | | |
| Information: | | | | | |
| 13 | Foreign Reference | FP41_JP2005284726_Ab_EFS.pdf | 87149 a50f669e1ef548e8e8461135369bdf93f6bb1b71 | no | 2 |
| Warnings: | | | | | |
| Information: | | | | | |
| 14 | Foreign Reference | FP41_JP2005284726_MachineTrans.pdf | 401055 3c73c24e2ef615976a418762c7f5787520df8f87 | no | 23 |
| Warnings: | | | | | |
| Information: | | | | | |
| 15 | Foreign Reference | FP41_JP2005284726A_EFS.pdf | 1010112 f4c916db711312295a604bf8985e22d0bdf707bd | no | 17 |
| Warnings: | | | | | |
| Information: | | | | | |
| 16 | Foreign Reference | FP42_GB2335105A_EFS.pdf | 1685410 715da2e9297342a2990d4f64b0b048129ffe309c | no | 23 |
| Warnings: | | | | | |
| Information: | | | | | |
| 17 | Foreign Reference | FP43_WO03023593.pdf | 1957018 579b1fab0dd1098b3c14a6d777bb7dda8c76db22 | no | 54 |
| Warnings: | | | | | |
| Information: | | | | | |
| 18 | Foreign Reference | FP44_KR2003-0088374_EFS.pdf | 8762462 f65dddc57588ceef8e1cfd42ee26351975d29732 | no | 84 |
| Warnings: | | | | | |
| Information: | | | | | |
| 19 | Foreign Reference | FP44_KR2003-0088374_English_Translation_EFS.pdf | 1414564 57256ff8471d075c16fd0027213bf754bb2a41d5 | no | 61 |
| Warnings: | | | | | |
| Information: | | | | | |

| | | | | | |
|--|-------------------|-------------------------------------|---|----|----|
| 20 | Foreign Reference | FP45_WO2008_085848.pdf | 3304175 dacd8cce29d7a29f60f13640fa49e8f5cedf4b9 | no | 97 |
| Warnings: | | | | | |
| The page size in the PDF is too large. The pages should be 8.5 x 11 or A4. If this PDF is submitted, the pages will be resized upon entry into the Image File Wrapper and may affect subsequent processing | | | | | |
| Information: | | | | | |
| 21 | Foreign Reference | FP46_JPS63-146168_EFS.pdf | 1850449 faca900923a98d278ccec615ae4c35774c46d8fb | no | 5 |
| Warnings: | | | | | |
| Information: | | | | | |
| 22 | Foreign Reference | FP46_JPS63146168_Ab.pdf | 83571 648de4c9989b46d01f20fddb216263facebed61c1 | no | 2 |
| Warnings: | | | | | |
| Information: | | | | | |
| 23 | Foreign Reference | FP47_JP2001-318665.pdf | 8641681 a08ec4c3c231af7f9935bf0f1d43276af4c9742 | no | 17 |
| Warnings: | | | | | |
| The page size in the PDF is too large. The pages should be 8.5 x 11 or A4. If this PDF is submitted, the pages will be resized upon entry into the Image File Wrapper and may affect subsequent processing | | | | | |
| Information: | | | | | |
| 24 | Foreign Reference | FP47_JP2001318665_Ab.pdf | 85185 228b9713df23b909ad6b76c20b3eb7e671eab9c7 | no | 2 |
| Warnings: | | | | | |
| Information: | | | | | |
| 25 | Foreign Reference | FP47_JP2001318665_MachineTrans.pdf | 288008 4947b86ed0930d7d1b1f4dd720abfb467dfe1bf2 | no | 14 |
| Warnings: | | | | | |
| Information: | | | | | |
| 26 | Foreign Reference | FP48_JP2006_154892_MachineTrans.pdf | 257560 bb78517957fc13888c1f922e5ea21f0390e11c13 | no | 13 |
| Warnings: | | | | | |
| Information: | | | | | |
| 27 | Foreign Reference | FP48_JP2006-154892A.pdf | 2865816 f67b5695d38c84451524a4513f6e932d46e920ae | no | 13 |
| Warnings: | | | | | |
| The page size in the PDF is too large. The pages should be 8.5 x 11 or A4. If this PDF is submitted, the pages will be resized upon entry into the Image File Wrapper and may affect subsequent processing | | | | | |

| | | | | | |
|--|-------------------|------------------------------------|---|----|----|
| Information: | | | | | |
| 28 | Foreign Reference | FP48_JP2006154892_Ab.pdf | 85880 b3ca9e01b6b4f20f163f0bfaf7c270506bfc66c | no | 2 |
| Warnings: | | | | | |
| Information: | | | | | |
| 29 | Foreign Reference | FP49_JP2006-090962A.pdf | 1497751 65bb7bbed1c381d8d13c6e7be975917bd4198e | no | 7 |
| Warnings: | | | | | |
| The page size in the PDF is too large. The pages should be 8.5 x 11 or A4. If this PDF is submitted, the pages will be resized upon entry into the Image File Wrapper and may affect subsequent processing | | | | | |
| Information: | | | | | |
| 30 | Foreign Reference | FP49_JP2006090962_Ab.pdf | 82121 4ca9ecc60c71b68454b8afb03e53eb2839ac2065 | no | 2 |
| Warnings: | | | | | |
| Information: | | | | | |
| 31 | Foreign Reference | FP50_JP2005-515530A.pdf | 2482801 552ff65dc5c11e064d0b1000895846ae6993f10d | no | 12 |
| Warnings: | | | | | |
| The page size in the PDF is too large. The pages should be 8.5 x 11 or A4. If this PDF is submitted, the pages will be resized upon entry into the Image File Wrapper and may affect subsequent processing | | | | | |
| Information: | | | | | |
| 32 | Foreign Reference | FP50_JP2005515530_Ab.pdf | 87526 c696f6fd45ca87d69888034c1bfa376977d13c94 | no | 2 |
| Warnings: | | | | | |
| Information: | | | | | |
| 33 | Foreign Reference | FP50_JP2005515530_MachineTrans.pdf | 202364 0eff658d5a21e21ad059bc88f6483c8d3f65468d | no | 10 |
| Warnings: | | | | | |
| Information: | | | | | |
| 34 | Foreign Reference | FP51_JP2003-108279A.pdf | 3131473 13e839f316743636fbb224d9c9f33f68e93c6ff | no | 14 |
| Warnings: | | | | | |
| The page size in the PDF is too large. The pages should be 8.5 x 11 or A4. If this PDF is submitted, the pages will be resized upon entry into the Image File Wrapper and may affect subsequent processing | | | | | |
| Information: | | | | | |
| 35 | Foreign Reference | FP51_JP2003108279_Ab.pdf | 93658 80d63d076f183f7327cc819f070ad9e7fa284eba | no | 2 |

Information:

| | | | | | |
|----|-------------------|--|--|----|----|
| 36 | Foreign Reference | FP51_JP2003108279_MachineT rans.pdf | 580585 | no | 30 |
| | | | de1354a1dd598303fe4da71a6425175fd0f2 9382 | | |

Warnings:

Information:

| | | | | | |
|----|-------------------|------------------------|--|----|---|
| 37 | Foreign Reference | FP52_JPH10-161628A.pdf | 3182404 | no | 6 |
| | | | ac775a4187100372bf6b853811102ef4c85c 7f0f | | |

Warnings:

The page size in the PDF is too large. The pages should be 8.5 x 11 or A4. If this PDF is submitted, the pages will be resized upon entry into the Image File Wrapper and may affect subsequent processing

Information:

| | | | | | |
|----|-------------------|-------------------------|--|----|---|
| 38 | Foreign Reference | FP52_JPH10161628_Ab.pdf | 86608 | no | 2 |
| | | | 3f6acbe227c1d03aee3b5c1a77719eb700d 51f04 | | |

Warnings:

Information:

| | | | | | |
|----|-------------------|------------------------|--|----|---|
| 39 | Foreign Reference | FP53_JPS63-206827A.pdf | 751744 | no | 5 |
| | | | 57a577068fc5046e1c205724bb663c557a9 0ce97 | | |

Warnings:

The page size in the PDF is too large. The pages should be 8.5 x 11 or A4. If this PDF is submitted, the pages will be resized upon entry into the Image File Wrapper and may affect subsequent processing

Information:

| | | | | | |
|----|-------------------|-------------------------|--|----|---|
| 40 | Foreign Reference | FP53_JPS63206827_Ab.pdf | 87246 | no | 2 |
| | | | 79a73b110fff914e84f7717b04838881cf7ef 54f | | |

Warnings:

Information:

| | | | | | |
|----|-------------------|-----------------------|---|----|---|
| 41 | Foreign Reference | FP54_JPH9-237175A.pdf | 4759257 | no | 9 |
| | | | 2d947b71a4d48b5ee1baa5fe8b9fba621e 5ba6b | | |

Warnings:

The page size in the PDF is too large. The pages should be 8.5 x 11 or A4. If this PDF is submitted, the pages will be resized upon entry into the Image File Wrapper and may affect subsequent processing

Information:

| | | | | | |
|----|-------------------|------------------------|---|----|---|
| 42 | Foreign Reference | FP54_JPH9237175_Ab.pdf | 83387 | no | 2 |
| | | | 7fa3843e8bad28508d8ae4f6c566eac8a309 9f0 | | |

Warnings:

Information:

| | | | | | |
|--|-------------------|----------------------------------|---|----|----|
| 43 | Foreign Reference | FP54_JPH9237175_MachineTrans.pdf | 296240 466dc37946d8b8a5b1cbfe34771442b04490736e | no | 14 |
| Warnings: | | | | | |
| Information: | | | | | |
| 44 | Foreign Reference | FP55_JPH8-249114A.pdf | 3721171 59526697141bb6ad922e723023d215764eaebe3 | no | 7 |
| Warnings: | | | | | |
| The page size in the PDF is too large. The pages should be 8.5 x 11 or A4. If this PDF is submitted, the pages will be resized upon entry into the Image File Wrapper and may affect subsequent processing | | | | | |
| Information: | | | | | |
| 45 | Foreign Reference | FP55_JPH8249114_Ab.pdf | 82758 2f6ea626ffa993c1f3ecc4781d1ed1fb98a38727 | no | 2 |
| Warnings: | | | | | |
| Information: | | | | | |
| 46 | Foreign Reference | FP55_JPH8249114_MachineTrans.pdf | 245243 f6e00decb8f9ebd57a8c65b748b48e96b377ec61 | no | 12 |
| Warnings: | | | | | |
| Information: | | | | | |
| 47 | Foreign Reference | FP56_JPH5-100809A.pdf | 7164870 063263c29c428e23b99820d7f1fabeb272319669 | no | 16 |
| Warnings: | | | | | |
| The page size in the PDF is too large. The pages should be 8.5 x 11 or A4. If this PDF is submitted, the pages will be resized upon entry into the Image File Wrapper and may affect subsequent processing | | | | | |
| Information: | | | | | |
| 48 | Foreign Reference | FP56_JPH5100809_Ab.pdf | 87302 174508497f9cf6196648f0adc1769b370a2677ca | no | 2 |
| Warnings: | | | | | |
| Information: | | | | | |
| 49 | Foreign Reference | FP56_JPH5100809_MachineTrans.pdf | 312009 af40f9ef10e588f36aed6951ff1a907a91dc0b17 | no | 14 |
| Warnings: | | | | | |
| Information: | | | | | |
| 50 | Foreign Reference | FP57_JP2000-181428A.pdf | 6887826 f6eb28eaf67aef96e2e221bb08576394ff92e111 | no | 11 |
| Warnings: | | | | | |
| The page size in the PDF is too large. The pages should be 8.5 x 11 or A4. If this PDF is submitted, the pages will be resized upon entry into the Image File Wrapper and may affect subsequent processing | | | | | |

| | | | | | |
|--|-------------------|--|---|----|----|
| Information: | | | | | |
| 51 | Foreign Reference | FP57_JP2000181428_MachineT rans.pdf | 428210 eedaa92a68f211c01a916642c73185cbcadd 6fd8 | no | 21 |
| Warnings: | | | | | |
| Information: | | | | | |
| 52 | Foreign Reference | FP57_JP2000181428_Ab.pdf | 84083 57a9ccce9a86504726f0eae04013b579081 53d8 | no | 2 |
| Warnings: | | | | | |
| Information: | | | | | |
| 53 | Foreign Reference | FP58_JP2005_267631A.pdf | 9518440 3d73f3fbf3d48425d2ea3c6e609feb33dbcf 4314 | no | 18 |
| Warnings: | | | | | |
| The page size in the PDF is too large. The pages should be 8.5 x 11 or A4. If this PDF is submitted, the pages will be resized upon entry into the Image File Wrapper and may affect subsequent processing | | | | | |
| Information: | | | | | |
| 54 | Foreign Reference | FP58_JP2005267631_Ab.pdf | 106162 e279655f2c6931241c4d418b3a4fa647cbf0 0689 | no | 2 |
| Warnings: | | | | | |
| Information: | | | | | |
| 55 | Foreign Reference | FP58_JP2005267631_MachineT rans.pdf | 307538 b4ab0310f40dbf449d6fcee18c44debcdd1a4 bdaa | no | 16 |
| Warnings: | | | | | |
| Information: | | | | | |
| 56 | Foreign Reference | FP59_JPH7-182134A.pdf | 2639061 0e2ea8fd025c28eb6a46cd5bf641b0946d4 1a732 | no | 5 |
| Warnings: | | | | | |
| The page size in the PDF is too large. The pages should be 8.5 x 11 or A4. If this PDF is submitted, the pages will be resized upon entry into the Image File Wrapper and may affect subsequent processing | | | | | |
| Information: | | | | | |
| 57 | Foreign Reference | FP59_JPH7182134_Ab.pdf | 81859 e57de84d9da00d503a4a020e567fcb2801 b810c | no | 2 |
| Warnings: | | | | | |
| Information: | | | | | |
| 58 | Foreign Reference | FP59_JPH7182134_MachineTra ns.pdf | 201570 26c3d74e7527afd42461ab3fc2946cc0780 93cc | no | 10 |
| Warnings: | | | | | |
| Information: | | | | | |

| | | | | | |
|----|-------------------|-------------------------|--|----|----|
| 59 | Foreign Reference | FP60_JP2004-310388A.pdf | 16736175 | no | 43 |
| | | | abe62d1f3cef79cb5a895e3c6fee1eed98fe4185 | | |

Warnings:

The page size in the PDF is too large. The pages should be 8.5 x 11 or A4. If this PDF is submitted, the pages will be resized upon entry into the Image File Wrapper and may affect subsequent processing

Information:

| | | | | | |
|----|-------------------|--------------------------|---|----|---|
| 60 | Foreign Reference | FP60_JP2004310388_Ab.pdf | 86200 | no | 2 |
| | | | 1588bf5f985dd52c7eb1f5c10c55909bb06d51c | | |

Warnings:**Information:**

| | |
|-------------------------------------|-----------|
| Total Files Size (in bytes): | 110713559 |
|-------------------------------------|-----------|

This Acknowledgement Receipt evidences receipt on the noted date by the USPTO of the indicated documents, characterized by the applicant, and including page counts, where applicable. It serves as evidence of receipt similar to a Post Card, as described in MPEP 503.

New Applications Under 35 U.S.C. 111

If a new application is being filed and the application includes the necessary components for a filing date (see 37 CFR 1.53(b)-(d) and MPEP 506), a Filing Receipt (37 CFR 1.54) will be issued in due course and the date shown on this Acknowledgement Receipt will establish the filing date of the application.

National Stage of an International Application under 35 U.S.C. 371

If a timely submission to enter the national stage of an international application is compliant with the conditions of 35 U.S.C. 371 and other applicable requirements a Form PCT/DO/EO/903 indicating acceptance of the application as a national stage submission under 35 U.S.C. 371 will be issued in addition to the Filing Receipt, in due course.

New International Application Filed with the USPTO as a Receiving Office

If a new international application is being filed and the international application includes the necessary components for an international filing date (see PCT Article 11 and MPEP 1810), a Notification of the International Application Number and of the International Filing Date (Form PCT/RO/105) will be issued in due course, subject to prescriptions concerning national security, and the date shown on this Acknowledgement Receipt will establish the international filing date of the application.

Electronic Acknowledgement Receipt

| | |
|---|--|
| EFS ID: | 14708741 |
| Application Number: | 90012304 |
| International Application Number: | |
| Confirmation Number: | 4807 |
| Title of Invention: | LIST SCROLLING AND DOCUMENT TRANSLATION, SCALING, AND ROTATION ON A TOUCH-SCREEN DISPLAY |
| First Named Inventor/Applicant Name: | 7,469,381 |
| Customer Number: | 108491 |
| Filer: | Kenneth James Weatherwax/Parham Hendifar |
| Filer Authorized By: | Kenneth James Weatherwax |
| Attorney Docket Number: | P4304USREX2/120730-002US |
| Receipt Date: | 15-JAN-2013 |
| Filing Date: | 23-MAY-2012 |
| Time Stamp: | 19:34:18 |
| Application Type: | Reexam (Third Party) |

Payment information:

| | |
|------------------------|----|
| Submitted with Payment | no |
|------------------------|----|

File Listing:

| Document Number | Document Description | File Name | File Size(Bytes)/ Message Digest | Multi Part /.zip | Pages (if appl.) |
|-----------------|-----------------------|--|---|------------------|------------------|
| 1 | Non Patent Literature | NPL167_Samsung_Opp_to_Ap ple_Motion_for_Prelim_Injunct ion.pdf | 2153353 d7cb77cd65d5bf0b2aaaa20c06358472776 ac81c | no | 10 |

Warnings:**Information:**

| | | | | | |
|--|-----------------------|---|--|----|----|
| 2 | Non Patent Literature | NPL164_BEDERSON_Depositio nTranscript.pdf | 9336631 3ffc8607b483aa2ca7fb69414638c15519b3 309 | no | 88 |
| Warnings: | | | | | |
| Information: | | | | | |
| 3 | Non Patent Literature | NPL163_BEDERSON_Declaratio n_August20-2011.pdf | 3609950 470f94c9de9f01d2f0d4716abc2e342e276 b0c2 | no | 12 |
| Warnings: | | | | | |
| Information: | | | | | |
| 4 | Non Patent Literature | NPL160_Day_14_HTC_v_Apple _11-05-12.PDF | 308818 5fb607b4749e7f941288a2da51177584afc5 ae85 | no | 32 |
| Warnings: | | | | | |
| Information: | | | | | |
| 5 | Non Patent Literature | NPL159_Day_13_HTC_v_Apple _10-05-12.PDF | 130303 6440d6bdaa0544d57500f544ed151de786 b3b095 | no | 14 |
| Warnings: | | | | | |
| Information: | | | | | |
| 6 | Non Patent Literature | NPL158_Day_12_HTC_v_Apple _09-05-12.PDF | 3770802 94c42afdd7dff6c25a20551b5eb379f3e6f98 70c8 | no | 22 |
| Warnings: | | | | | |
| The page size in the PDF is too large. The pages should be 8.5 x 11 or A4. If this PDF is submitted, the pages will be resized upon entry into the Image File Wrapper and may affect subsequent processing | | | | | |
| Information: | | | | | |
| 7 | Non Patent Literature | NPL157_Day_11_HTC_v_Apple _08-05-12.PDF | 374999 710b9d6f867ea261b590f284e0d8ae40c91 bd2ae | no | 40 |
| Warnings: | | | | | |
| Information: | | | | | |
| 8 | Non Patent Literature | NPL156_Day_10_HTC_v_Apple _03-05-12.PDF | 367337 d6e069fc227c24fb9c607237da16b293259 8787d | no | 38 |
| Warnings: | | | | | |
| Information: | | | | | |
| 9 | Non Patent Literature | NPL155_Day_9_HTC_v_Apple_ 02-05-12.PDF | 642516 6850255c5f603d0511f6d3618e943b671c6 9281c | no | 44 |
| Warnings: | | | | | |
| Information: | | | | | |
| 10 | Non Patent Literature | NPL154_Day_8_HTC_v_Apple_ 01-05-12.PDF | 609745 7f44e90e20a3078df4cf46a5ce62ca45355e 9072 | no | 43 |

| | | | | | |
|--|-----------------------|---|---|----|-----|
| Warnings: | | | | | |
| Information: | | | | | |
| 11 | Non Patent Literature | NPL152_2012-05-16_Particulars_of_Invalidity-540_Patent.pdf | 121151 c0a2c9adba90d88303fd0de1362bc8245669ec5 | no | 7 |
| Warnings: | | | | | |
| Information: | | | | | |
| 12 | Non Patent Literature | NPL151_2012-05-16_Particulars_of_Invalidity-372_Patent.pdf | 129966 2f46eaba57c99f0eb3d1d966cf5601e747fe853e | no | 5 |
| Warnings: | | | | | |
| Information: | | | | | |
| 13 | Non Patent Literature | NPL150_2012-05-16_Particulars_of_Invalidity-366_Patent.pdf | 137301 8421645912c0da48f84a882bc61855474bddd253 | no | 7 |
| Warnings: | | | | | |
| Information: | | | | | |
| 14 | Non Patent Literature | NPL148_2012-05-16_Particulars_of_Invalidity_103_Patent.pdf | 117900 52128dc0c4c5981f6aaf66e8ddc55afa9f336bf61 | no | 6 |
| Warnings: | | | | | |
| Information: | | | | | |
| 15 | Non Patent Literature | NPL147_User_manual_HTC_P_3050.pdf | 7501212 8d7ba84d02c35c915a03bb56976b897bc3fb8834 | no | 154 |
| Warnings: | | | | | |
| The page size in the PDF is too large. The pages should be 8.5 x 11 or A4. If this PDF is submitted, the pages will be resized upon entry into the Image File Wrapper and may affect subsequent processing | | | | | |
| Information: | | | | | |
| 16 | Non Patent Literature | NPL145_2012-11-28_Judgment_in_Substantive_Proceedings_Dutch.pdf | 1213176 c4eb1e5be62ec31176ed1d6051334b4e7c2bb22a | no | 22 |
| Warnings: | | | | | |
| Information: | | | | | |
| 17 | Non Patent Literature | NPL137_2011-11-07_HTC_Amended_Notice_of_Prior_Art.pdf | 644702 f9281de13ebd509611011d842cba6a4c527f363d | no | 79 |
| Warnings: | | | | | |
| Information: | | | | | |
| 18 | Non Patent Literature | NPL135_slides_Input_Technique.pdf | 841507 ea9c1bc15a51724f7b149b840c3e1acd66c06a70 | no | 44 |
| Warnings: | | | | | |
| Information: | | | | | |

| | | | | | |
|---------------------|-----------------------|--|---|----|----|
| 19 | Non Patent Literature | NPL134_Schedule_and_Abst cts.pdf | 4429764 eab9714a90eae034912149fca37757b849e 6ec04 | no | 13 |
| Warnings: | | | | | |
| Information: | | | | | |
| 20 | Non Patent Literature | NPL133_CHI2005_Paper_Abst racts.pdf | 1253086 8cdf3d5780d4857c82747052c34a0d5fefed e637 | no | 3 |
| Warnings: | | | | | |
| Information: | | | | | |
| 21 | Non Patent Literature | NPL132_CHI2005_dates.pdf | 770096 96cfd61f6a6c42436bb353a0d566d21e117 86a72 | no | 2 |
| Warnings: | | | | | |
| Information: | | | | | |
| 22 | Non Patent Literature | NPL131_Karlson_AppLens_and _Launchtile_ppt.pdf | 3549987 fd8c82d915b1a65cb11ead250f5c3beefab2 a70f | no | 17 |
| Warnings: | | | | | |
| Information: | | | | | |
| 23 | Non Patent Literature | NPL130_2012-09-20_Rejection _Decision.pdf | 994088 90ac616fda03e5abea2869e1950bb96db4e d86e9 | no | 22 |
| Warnings: | | | | | |
| Information: | | | | | |
| 24 | Non Patent Literature | NPL129_2011_10_31_Europea n_Search_Opinion.pdf | 46359 a6ca85eafa92446c1fd7d4fab3cdab50975f 8e8 | no | 2 |
| Warnings: | | | | | |
| Information: | | | | | |
| 25 | Non Patent Literature | NPL127_Request_Further_Proc essing_20121022.pdf | 289250 c025cef3d0f3e88dd2de2db2b01ea139b8 a32d1 | no | 4 |
| Warnings: | | | | | |
| Information: | | | | | |
| 26 | Non Patent Literature | NPL126_Request_Further_Proc essing_20121022.pdf | 370051 1d0d39e82754c154d5f9c16ac3b4159f13b e1e07 | no | 6 |
| Warnings: | | | | | |
| Information: | | | | | |
| 27 | Non Patent Literature | NPL125_2008_09_19_Notice_C ertification.pdf | 54379 1aec2404a54d4b82034b801926ae507ec2b a7aa0 | no | 1 |
| Warnings: | | | | | |
| Information: | | | | | |

| | | | | | |
|---------------------|-----------------------|---|---|----|----|
| 28 | Non Patent Literature | NPL124_2008_09_12_Respons e_Examiners_Report_No1.pdf | 1023723 cc641c8cd451895fa6a533e20a872715896e 3e35 | no | 18 |
| Warnings: | | | | | |
| Information: | | | | | |
| 29 | Non Patent Literature | NPL123_2008_05_15_Search_I nformation_Statement.pdf | 11810 5143e7e27a6b8227dadf581081d45db24b 4b03cf | no | 1 |
| Warnings: | | | | | |
| Information: | | | | | |
| 30 | Non Patent Literature | NPL122_2008_05_16_Examiner s_Report_No1.pdf | 54581 07af2b94140fb5788ad828577005224b171 02850 | no | 1 |
| Warnings: | | | | | |
| Information: | | | | | |
| 31 | Non Patent Literature | NPL121_2010_05_05_Reply_to _Communicationfrom_Examini ng_Division.pdf | 217359 eff2230c5430d05c37e56d229a36f14aa43c 19e3 | no | 7 |
| Warnings: | | | | | |
| Information: | | | | | |
| 32 | Non Patent Literature | NPL120_2011_04_11_Respons e_Examiners_Report_No1.pdf | 317427 52386bd12f445b544bc230043dc64456b12 9ed75 | no | 9 |
| Warnings: | | | | | |
| Information: | | | | | |
| 33 | Non Patent Literature | NPL118_2011_11_29_Europea n_Search_Opinion.pdf | 152730 33a84a9dc31a19f1d94cd92b95545d4f998 db042 | no | 3 |
| Warnings: | | | | | |
| Information: | | | | | |
| 34 | Non Patent Literature | NPL117_2009_03_31_Notice_A cceptance.pdf | 88631 141b3d417a6492138bd81f2aff3de9fea55c d827 | no | 1 |
| Warnings: | | | | | |
| Information: | | | | | |
| 35 | Non Patent Literature | NPL116_2009_03_12_Respons e_Examiners_Report_No1.pdf | 40228 f8866cbf462ba861ce8c9fd7be12c253b5bd 7b23 | no | 1 |
| Warnings: | | | | | |
| Information: | | | | | |
| 36 | Non Patent Literature | NPL115_2009_02_10_Search_I nformation_Statement.pdf | 52941 af1ae1075ec2c6f992a5ce4d005a694a5646 8eba | no | 2 |
| Warnings: | | | | | |
| Information: | | | | | |

| | | | | | |
|-------------------------------------|-----------------------|--|---|----|----|
| 37 | Non Patent Literature | NPL114_2011-12-01_European_Search_Opinion.pdf | 209949 16d3c91b37e164c6fdd953a9df914c11ae9b936 | no | 4 |
| Warnings: | | | | | |
| Information: | | | | | |
| 38 | Non Patent Literature | NPL113_IPRP_WO2008086218_AU540_family.pdf | 705475 258a25c9c4d629ad486891f05d724c3b377ba240 | no | 15 |
| Warnings: | | | | | |
| Information: | | | | | |
| 39 | Non Patent Literature | NPL112_ISR_WO2008086218_AU540_family.pdf | 260539 801fa643369dac25547bf421da22117ea22e9caff | no | 7 |
| Warnings: | | | | | |
| Information: | | | | | |
| 40 | Non Patent Literature | NPL111_2009_08_24_Notice_Acceptance.pdf | 88633 3c34a88a3b7ab8ee2fdd0c7ab8256d6b882fb2bb | no | 1 |
| Warnings: | | | | | |
| Information: | | | | | |
| 41 | Non Patent Literature | NPL110_2009_08_03_Response_Examiners_Report3.pdf | 40395 023332268a46283a5dae98b013a1150202a794b2 | no | 1 |
| Warnings: | | | | | |
| Information: | | | | | |
| Total Files Size (in bytes): | | | 47032850 | | |

This Acknowledgement Receipt evidences receipt on the noted date by the USPTO of the indicated documents, characterized by the applicant, and including page counts, where applicable. It serves as evidence of receipt similar to a Post Card, as described in MPEP 503.

New Applications Under 35 U.S.C. 111

If a new application is being filed and the application includes the necessary components for a filing date (see 37 CFR 1.53(b)-(d) and MPEP 506), a Filing Receipt (37 CFR 1.54) will be issued in due course and the date shown on this Acknowledgement Receipt will establish the filing date of the application.

National Stage of an International Application under 35 U.S.C. 371

If a timely submission to enter the national stage of an international application is compliant with the conditions of 35 U.S.C. 371 and other applicable requirements a Form PCT/DO/EO/903 indicating acceptance of the application as a national stage submission under 35 U.S.C. 371 will be issued in addition to the Filing Receipt, in due course.

New International Application Filed with the USPTO as a Receiving Office

If a new international application is being filed and the international application includes the necessary components for an international filing date (see PCT Article 11 and MPEP 1810), a Notification of the International Application Number and of the International Filing Date (Form PCT/RO/105) will be issued in due course, subject to prescriptions concerning national security, and the date shown on this Acknowledgement Receipt will establish the international filing date of the application.

Electronic Acknowledgement Receipt

| | |
|---|--|
| EFS ID: | 14709003 |
| Application Number: | 90012304 |
| International Application Number: | |
| Confirmation Number: | 4807 |
| Title of Invention: | LIST SCROLLING AND DOCUMENT TRANSLATION, SCALING, AND ROTATION ON A TOUCH-SCREEN DISPLAY |
| First Named Inventor/Applicant Name: | 7,469,381 |
| Customer Number: | 108491 |
| Filer: | Kenneth James Weatherwax/Qing Ye |
| Filer Authorized By: | Kenneth James Weatherwax |
| Attorney Docket Number: | P4304USREX2/120730-002US |
| Receipt Date: | 15-JAN-2013 |
| Filing Date: | 23-MAY-2012 |
| Time Stamp: | 20:20:24 |
| Application Type: | Reexam (Third Party) |

Payment information:

| | |
|------------------------|----|
| Submitted with Payment | no |
|------------------------|----|

File Listing:

| Document Number | Document Description | File Name | File Size(Bytes)/ Message Digest | Multi Part /.zip | Pages (if appl.) |
|-----------------|----------------------|---|---|------------------|------------------|
| 1 | Foreign Reference | FP60_JP2004310388_MachineTranslations.pdf | 940209 <small>8c8c79ce6c8b5d24c5343bcff6039e6f341f9338</small> | no | 73 |

Warnings:**Information:**

| | | | | | |
|--|-------------------|--|---|----|----|
| 2 | Foreign Reference | FP61_JP2000-333044A.pdf | 4961811 8bf05109c732204f753bc1b8da9bc9b72534eb0f | no | 9 |
| Warnings: | | | | | |
| The page size in the PDF is too large. The pages should be 8.5 x 11 or A4. If this PDF is submitted, the pages will be resized upon entry into the Image File Wrapper and may affect subsequent processing | | | | | |
| Information: | | | | | |
| 3 | Foreign Reference | FP61_JP2000333044_Ab.pdf | 94545 62d88a5f68ed257df1d2e1fe65b9e67015fb75c3 | no | 2 |
| Warnings: | | | | | |
| Information: | | | | | |
| 4 | Foreign Reference | FP61_JP2000333044_MachineT rans.pdf | 437355 c94abab3b5aa3fc5c3561006f49b61802c4f55a3 | no | 20 |
| Warnings: | | | | | |
| Information: | | | | | |
| 5 | Foreign Reference | FP62_JP2006-244353A.pdf | 6507203 2fedeb1ce7a467c25d5963e77b632a7868c779f3 | no | 14 |
| Warnings: | | | | | |
| The page size in the PDF is too large. The pages should be 8.5 x 11 or A4. If this PDF is submitted, the pages will be resized upon entry into the Image File Wrapper and may affect subsequent processing | | | | | |
| Information: | | | | | |
| 6 | Foreign Reference | FP62_JP2006244353_Ab.pdf | 89356 cf0a431f7d4371c2c8a1125c49d580c13dfae1e | no | 2 |
| Warnings: | | | | | |
| Information: | | | | | |
| 7 | Foreign Reference | FP62_JP2006244353_MachineT rans.pdf | 217489 d8ce3a8242631be4e128747828dbfa3256d25a51 | no | 11 |
| Warnings: | | | | | |
| Information: | | | | | |
| 8 | Foreign Reference | FP63_JP2006-179006A.pdf | 9120431 55efcbabcaab9d095c6aab8946bd652a0f27c095 | no | 20 |
| Warnings: | | | | | |
| The page size in the PDF is too large. The pages should be 8.5 x 11 or A4. If this PDF is submitted, the pages will be resized upon entry into the Image File Wrapper and may affect subsequent processing | | | | | |
| Information: | | | | | |
| 9 | Foreign Reference | FP63_JP2006179006_MachineT rans.pdf | 192607 d481f16df956134eaf840937cd00a1e8d00f8040 | no | 10 |
| Warnings: | | | | | |

| | | | | | |
|---------------------|-----------------------|--|--|----|-----|
| Information: | | | | | |
| 10 | Foreign Reference | FP64_EP0701220A1.pdf | 1594019 f88a8e62df94209a55f1b2754350d5956ce5b0e6 | no | 32 |
| Warnings: | | | | | |
| Information: | | | | | |
| 11 | Foreign Reference | FP65_WO03060622A2.pdf | 631386 bd6c36bd0317ddae0b2bae706f8bebb21c8c9d9d | no | 14 |
| Warnings: | | | | | |
| Information: | | | | | |
| 12 | Foreign Reference | FP66_WO2005052773A2.pdf | 830665 d52984e6e50fac6a83ac300c9dc7863ae28ccf | no | 26 |
| Warnings: | | | | | |
| Information: | | | | | |
| 13 | Foreign Reference | FP67_WO2006003591A2.pdf | 560298 89af1734b05b72bc0158fde70603892dd302deea | no | 16 |
| Warnings: | | | | | |
| Information: | | | | | |
| 14 | Foreign Reference | FP68_WO2006020305A2.pdf | 3592056 c88daa032c8fb5f8646b751412bcfd570cbf1188 | no | 87 |
| Warnings: | | | | | |
| Information: | | | | | |
| 15 | Non Patent Literature | NPL23_Wireless_News_Adobe_Rolls_Out.pdf | 4106064 dd15d0abae35cad4aa9196f5e3033c64c2644567 | no | 8 |
| Warnings: | | | | | |
| Information: | | | | | |
| 16 | Non Patent Literature | NPL24_Denning_Invisible_Future.pdf | 25295808 4ae97c4086d227c8eaf6bc191fc46c0a70894af1 | no | 363 |
| Warnings: | | | | | |
| Information: | | | | | |
| 17 | Non Patent Literature | NPL27_ERICKSON_Working_Interface_Metaphors.pdf | 1601293 a8acdb36d167782cd4d65abfc1bbea1d5ff1235a | no | 19 |
| Warnings: | | | | | |
| Information: | | | | | |
| 18 | Non Patent Literature | NPL28_FlashToTheCoreWebsite.pdf | 318432 b1ac564e19a780f16f9ae0d1a6ce089107e0c60d | no | 1 |
| Warnings: | | | | | |

| | | | | | |
|---------------------|-----------------------|---|--|----|---|
| Information: | | | | | |
| 19 | Non Patent Literature | NPL29_Flashloaded_SlideMenu_Website.pdf | 1044478 | no | 3 |
| | | | 2b30345578d91834424a3397b38b4e00d9ce44ff | | |

Warnings:**Information:**

| | | | | | |
|----|-----------------------|---------------------------------|--|----|---|
| 20 | Non Patent Literature | NPL30_Patel_improving_photo.pdf | 695600 | no | 8 |
| | | | d72c7b0bd4ec65864231693dacl8b6b6c6a438bf | | |

Warnings:**Information:**

| | | | | | |
|-------------------------------------|--|--|----------|--|--|
| Total Files Size (in bytes): | | | 62831105 | | |
|-------------------------------------|--|--|----------|--|--|

This Acknowledgement Receipt evidences receipt on the noted date by the USPTO of the indicated documents, characterized by the applicant, and including page counts, where applicable. It serves as evidence of receipt similar to a Post Card, as described in MPEP 503.

New Applications Under 35 U.S.C. 111

If a new application is being filed and the application includes the necessary components for a filing date (see 37 CFR 1.53(b)-(d) and MPEP 506), a Filing Receipt (37 CFR 1.54) will be issued in due course and the date shown on this Acknowledgement Receipt will establish the filing date of the application.

National Stage of an International Application under 35 U.S.C. 371

If a timely submission to enter the national stage of an international application is compliant with the conditions of 35 U.S.C. 371 and other applicable requirements a Form PCT/DO/EO/903 indicating acceptance of the application as a national stage submission under 35 U.S.C. 371 will be issued in addition to the Filing Receipt, in due course.

New International Application Filed with the USPTO as a Receiving Office

If a new international application is being filed and the international application includes the necessary components for an international filing date (see PCT Article 11 and MPEP 1810), a Notification of the International Application Number and of the International Filing Date (Form PCT/RO/105) will be issued in due course, subject to prescriptions concerning national security, and the date shown on this Acknowledgement Receipt will establish the international filing date of the application.

Electronic Acknowledgement Receipt

| | |
|---|--|
| EFS ID: | 14709125 |
| Application Number: | 90012304 |
| International Application Number: | |
| Confirmation Number: | 4807 |
| Title of Invention: | LIST SCROLLING AND DOCUMENT TRANSLATION, SCALING, AND ROTATION ON A TOUCH-SCREEN DISPLAY |
| First Named Inventor/Applicant Name: | 7,469,381 |
| Customer Number: | 108491 |
| Filer: | Kenneth James Weatherwax/Qing Ye |
| Filer Authorized By: | Kenneth James Weatherwax |
| Attorney Docket Number: | P4304USREX2/120730-002US |
| Receipt Date: | 15-JAN-2013 |
| Filing Date: | 23-MAY-2012 |
| Time Stamp: | 20:45:54 |
| Application Type: | Reexam (Third Party) |

Payment information:

| | |
|------------------------|----|
| Submitted with Payment | no |
|------------------------|----|

File Listing:

| Document Number | Document Description | File Name | File Size(Bytes)/ Message Digest | Multi Part /.zip | Pages (if appl.) |
|-----------------|-----------------------|---|--|------------------|------------------|
| 1 | Non Patent Literature | NPL107_2009-04-01_Examiners_Report_No_2_EFS.pdf | 102176 44f954634b2f7cbb1ea664125d8b271d32f624be | no | 2 |

Warnings:**Information:**

| | | | | | |
|---------------------|-----------------------|---|--|----|----|
| 2 | Non Patent Literature | NPL109_2008_06_28_Copy_of_International_Search_Report_EFS.pdf | 407025 ac4e0a90e56b2ad57787ccbe6276b5bb612fcbcb | no | 5 |
| Warnings: | | | | | |
| Information: | | | | | |
| 3 | Non Patent Literature | NPL128_2011_10_31_Europea_n_Search_Report_EFS.pdf | 153673 6de6197816b330cb07c9732a56b13cf9bab744d5 | no | 2 |
| Warnings: | | | | | |
| Information: | | | | | |
| 4 | Non Patent Literature | NPL136_2012-02-07_Markman_Hearing_Transcript-Day_EFS.pdf | 446211 9894043bf7ac8c80ca40447c17bb6b2a7e7a4bcb | no | 31 |
| Warnings: | | | | | |
| Information: | | | | | |
| 5 | Non Patent Literature | NPL138_2012-08-14_Hearing_Transcript_EFS.pdf | 471963 fd777afdf78e2badb1d9f13963db2338f7d817 | no | 31 |
| Warnings: | | | | | |
| Information: | | | | | |
| 6 | Non Patent Literature | NPL139_2012-08-15_Hearing_Transcript_EFS.pdf | 156608 faee5b29a8d5af2eb754563d67ba9585fef40a37 | no | 9 |
| Warnings: | | | | | |
| Information: | | | | | |
| 7 | Non Patent Literature | NPL140_2012-08-16_Hearing_Transcript_EFS.pdf | 864725 1c25eb6227f1e9b88fd8c1d3cc8ba576c717c769 | no | 59 |
| Warnings: | | | | | |
| Information: | | | | | |
| 8 | Non Patent Literature | NPL141_2012-08-17_Hearing_Transcript_EFS.pdf | 171783 000a4aef49980637423ef0b852dcec7b0a3d448e | no | 10 |
| Warnings: | | | | | |
| Information: | | | | | |
| 9 | Non Patent Literature | NPL142_2012-08-22_Hearing_Transcript_EFS.pdf | 222574 7bcead48abee7acd7338b9005db4e1af55bf10bd | no | 14 |
| Warnings: | | | | | |
| Information: | | | | | |
| 10 | Non Patent Literature | NPL143_2012-08-24_Hearing_Transcript_EFS.pdf | 411948 ce09b22c4b42c73b0e1a4c3edc421b0ec579af69 | no | 27 |
| Warnings: | | | | | |
| Information: | | | | | |

| | | | | | |
|---------------------|-----------------------|---|---|----|----|
| 11 | Non Patent Literature | NPL144_2011-08-24_PI_Decision_Dutch_EFS.pdf | 1850961 81d1b31d63320ad49759385fb2437319409b1459 | no | 65 |
| Warnings: | | | | | |
| Information: | | | | | |
| 12 | Non Patent Literature | NPL146_2012-11-28_Judgment_in_Substantive_Proceedings_English_EFS.pdf | 781805 fa4ac2ef7092635b79aacca7e07617ce62d91440 | no | 21 |
| Warnings: | | | | | |
| Information: | | | | | |
| 13 | Non Patent Literature | NPL149_2012-05-16_Particulars_of_Invalidity_283_Patent_EFS.pdf | 372179 7ccbee17ed3e9178ed673534b56e940b68e6c68 | no | 6 |
| Warnings: | | | | | |
| Information: | | | | | |
| 14 | Non Patent Literature | NPL153_2012-07-04_HTC_v_Apple-Approved_judgment_EFS.pdf | 1912646 41c3793f35f9c5669d2cc9bb44db5c32097c5d15 | no | 81 |
| Warnings: | | | | | |
| Information: | | | | | |
| 15 | Non Patent Literature | NPL161_2012-05-02-Apple-Van_Dam-TS-Compressed_EFS.pdf | 483079 1abc295b1c08cf9e791084e59a4ea39bd03ea87e | no | 26 |
| Warnings: | | | | | |
| Information: | | | | | |
| 16 | Non Patent Literature | NPL162_2011-09-14-Apple-Van_Dam-Compressed_EFS.pdf | 985727 a50380d12c5dd7e565246ebc09a433ba4644874c | no | 59 |
| Warnings: | | | | | |
| Information: | | | | | |
| 17 | Non Patent Literature | NPL165_2011-07-01_086-0_Apple_Motion_for_Prelim_Injunction_EFS.pdf | 394847 ca5cb15fe4bc29710b0ed59c34c8ac27147f6630 | no | 8 |
| Warnings: | | | | | |
| Information: | | | | | |
| 18 | Non Patent Literature | NPL166_Balakrishnan_Declaration_of_Exhibts_ISO_PI_EFS.pdf | 818189 9ccb58e58c75f956b85d3a3cb6b47be3dfa9e58d | no | 30 |
| Warnings: | | | | | |
| Information: | | | | | |
| 19 | Non Patent Literature | NPL168_Declaration_of_Van_Dam_EFS.pdf | 1204726 c11d783bcac30947fd08101b84fa44fad35c955f | no | 50 |
| Warnings: | | | | | |
| Information: | | | | | |

| | | | | | |
|----|-----------------------|--|---|----|---|
| 20 | Non Patent Literature | NPL119_2010-04-07_Search_Information_Statement_EFS.pdf | 271100 007ebc9d37fd7e662b9a9e2cdfb77b308e9c9f4 | no | 3 |
|----|-----------------------|--|---|----|---|

Warnings:**Information:**

| | | | | | |
|----|-----------------------|--|--|----|---|
| 21 | Non Patent Literature | NPL169_2011-09-30_Reply_iso_Motion_for_PI_REDACTED_EFS.pdf | 165217 b64f7f4090a18b2dd81c04635fe45c073e902ea9 | no | 8 |
|----|-----------------------|--|--|----|---|

Warnings:**Information:****Total Files Size (in bytes):**

12649162

This Acknowledgement Receipt evidences receipt on the noted date by the USPTO of the indicated documents, characterized by the applicant, and including page counts, where applicable. It serves as evidence of receipt similar to a Post Card, as described in MPEP 503.

New Applications Under 35 U.S.C. 111

If a new application is being filed and the application includes the necessary components for a filing date (see 37 CFR 1.53(b)-(d) and MPEP 506), a Filing Receipt (37 CFR 1.54) will be issued in due course and the date shown on this Acknowledgement Receipt will establish the filing date of the application.

National Stage of an International Application under 35 U.S.C. 371

If a timely submission to enter the national stage of an international application is compliant with the conditions of 35 U.S.C. 371 and other applicable requirements a Form PCT/DO/EO/903 indicating acceptance of the application as a national stage submission under 35 U.S.C. 371 will be issued in addition to the Filing Receipt, in due course.

New International Application Filed with the USPTO as a Receiving Office

If a new international application is being filed and the international application includes the necessary components for an international filing date (see PCT Article 11 and MPEP 1810), a Notification of the International Application Number and of the International Filing Date (Form PCT/RO/105) will be issued in due course, subject to prescriptions concerning national security, and the date shown on this Acknowledgement Receipt will establish the international filing date of the application.

Electronic Acknowledgement Receipt

| | |
|---|--|
| EFS ID: | 14708300 |
| Application Number: | 90012304 |
| International Application Number: | |
| Confirmation Number: | 4807 |
| Title of Invention: | LIST SCROLLING AND DOCUMENT TRANSLATION, SCALING, AND ROTATION ON A TOUCH-SCREEN DISPLAY |
| First Named Inventor/Applicant Name: | 7,469,381 |
| Customer Number: | 108491 |
| Filer: | Kenneth James Weatherwax |
| Filer Authorized By: | |
| Attorney Docket Number: | P4304USREX2/120730-002US |
| Receipt Date: | 15-JAN-2013 |
| Filing Date: | 23-MAY-2012 |
| Time Stamp: | 20:47:06 |
| Application Type: | Reexam (Third Party) |

Payment information:

| | |
|------------------------|----|
| Submitted with Payment | no |
|------------------------|----|

File Listing:

| Document Number | Document Description | File Name | File Size(Bytes)/ Message Digest | Multi Part /.zip | Pages (if appl.) |
|-----------------|----------------------|-------------------------------------|--|------------------|------------------|
| 1 | Foreign Reference | FP1_CN1754141A_Abstract_EF S.pdf | 85459 <small>c7f5009b1e0e64c9bcd2770e6631c775ac95f993</small> | no | 2 |

Warnings:**Information:**

| | | | | | |
|---------------------|-------------------|-------------------------------------|---|----|----|
| 2 | Foreign Reference | FP1_CN1754141A_EFS.pdf | 2103409 4b9ac505c96375fbb0c545dd2956ac4dec1 0e0a2 | no | 21 |
| Warnings: | | | | | |
| Information: | | | | | |
| 3 | Foreign Reference | FP2_DE102008052485_Abstract_EFS.pdf | 46511 57d18e29f3a6d92183fd7d021b78693e4f8 b23af | no | 1 |
| Warnings: | | | | | |
| Information: | | | | | |
| 4 | Foreign Reference | FP2_DE102008052485A1_EFS.pdf | 1855751 4e51be51dde694f1fe4f2e02efb93593dc15 380f | no | 18 |
| Warnings: | | | | | |
| Information: | | | | | |
| 5 | Foreign Reference | FP3_EP0944218A1_Abstract_EFS.pdf | 82057 937e3b1176c155127cad75d81cbd46dce7c 2f21b | no | 1 |
| Warnings: | | | | | |
| Information: | | | | | |
| 6 | Foreign Reference | FP3_EP0944218A1_EFS.pdf | 456634 e5bdf028a8183ef1690570997648ccd17ec1 9073 | no | 7 |
| Warnings: | | | | | |
| Information: | | | | | |
| 7 | Foreign Reference | FP4_EP0725331A1_Abstract_EFS.pdf | 69066 52495500f07344851daf3fa3d4281459e6b1 43d8 | no | 1 |
| Warnings: | | | | | |
| Information: | | | | | |
| 8 | Foreign Reference | FP5_EP1517228A2_EFS.pdf | 711181 0dd7d3d518dbf75852033aa70a67542c1d9 87ebe | no | 13 |
| Warnings: | | | | | |
| Information: | | | | | |
| 9 | Foreign Reference | FP6_EP2102738A1.pdf | 3130148 69eb395bff77cc0fc3549cc5bde5d8267ba d17e | no | 97 |
| Warnings: | | | | | |
| Information: | | | | | |
| 10 | Foreign Reference | FP7_GB2319591A.pdf | 1261597 85aca29ca8c1ee45a1884dc7b40288e9aea 921bb | no | 31 |
| Warnings: | | | | | |
| Information: | | | | | |

| | | | | | |
|---------------------|-------------------|---|---|----|----|
| 11 | Foreign Reference | FP8_JP1999126149_Abstract_EFS.pdf | 58311 dab66c89608e02408e038f3c2a8429e76ab05d71 | no | 1 |
| Warnings: | | | | | |
| Information: | | | | | |
| 12 | Foreign Reference | FP8_JP1999126149_EFS.pdf | 837260 d7e8389d0c50889891023735c76ea53c8b2995bd | no | 10 |
| Warnings: | | | | | |
| Information: | | | | | |
| 13 | Foreign Reference | FP8_JP1999126149_MachineTrans.pdf | 266898 3ebd4ad0375836c1cb94a5ecc5eff30a7092cf3a | no | 13 |
| Warnings: | | | | | |
| Information: | | | | | |
| 14 | Foreign Reference | FP9_JP2000163031A_Abstract_EFS.pdf | 95735 e5ace8af67c61fff137741c22673659bf12dccc9d | no | 2 |
| Warnings: | | | | | |
| Information: | | | | | |
| 15 | Foreign Reference | FP9_JP2000163031A_EFS.pdf | 1984214 72e5e0679be21a59410cbf508ebab733ecd3c182 | no | 30 |
| Warnings: | | | | | |
| Information: | | | | | |
| 16 | Foreign Reference | FP9_JP2000163031A_MachineTrans_EFS.pdf | 367206 c618d16c81d0d10a024135d404d645ade91cc140 | no | 18 |
| Warnings: | | | | | |
| Information: | | | | | |
| 17 | Foreign Reference | FP10_JP2000322495A_Abstract_EFS.pdf | 92527 c552ec976afb34a490a642bed73597049dcb7b26e | no | 2 |
| Warnings: | | | | | |
| Information: | | | | | |
| 18 | Foreign Reference | FP10_JP2000322495A_EFS.pdf | 444464 038147797b3763cfef82304930b91d3ad140c6c | no | 7 |
| Warnings: | | | | | |
| Information: | | | | | |
| 19 | Foreign Reference | FP10_JP2000322495A_MachineTrans_EFS.pdf | 198178 30f3f04d71afe4a684a12ff11c05444fd4f913e1 | no | 9 |
| Warnings: | | | | | |
| Information: | | | | | |

| | | | | | |
|---------------------|-------------------|---|---|----|----|
| 20 | Foreign Reference | FP11_JP2002254614A_Abstract_EFS.pdf | 85118 f7612b077f9060707c4ddc258a04273736e752f | no | 2 |
| Warnings: | | | | | |
| Information: | | | | | |
| 21 | Foreign Reference | FP11_JP2002254614A_EFS.pdf | 586797 1813470c22243457dae44ed6c97ae61856fbc7f | no | 8 |
| Warnings: | | | | | |
| Information: | | | | | |
| 22 | Foreign Reference | FP11_JP2002254614A_MachineTrans_EFS.pdf | 230037 913e37aaefca6073cfeac24155c80ee0a49df262 | no | 11 |
| Warnings: | | | | | |
| Information: | | | | | |
| 23 | Foreign Reference | FP12_200234033_Abs.pdf | 94393 81a65d29421c7f8c75ae0cf893ac5dc8ce584659 | no | 2 |
| Warnings: | | | | | |
| Information: | | | | | |
| 24 | Foreign Reference | FP12_JP2002342033A_EFS.pdf | 699421 0f9037b26bc1c2378aea355d937f442ddc6eb41e | no | 9 |
| Warnings: | | | | | |
| Information: | | | | | |
| 25 | Foreign Reference | FP12_JP2002342033A_MachineTrans.pdf | 329753 791293f93b01ecea16cd817961a660c550c006f6 | no | 15 |
| Warnings: | | | | | |
| Information: | | | | | |
| 26 | Foreign Reference | FP13_JP2003330613A_Abstract_EFS.pdf | 90176 3dd509a0b8047cdc773deb135017ad6b779789 | no | 2 |
| Warnings: | | | | | |
| Information: | | | | | |
| 27 | Foreign Reference | FP13_JP2003330613A_EFS.pdf | 1993506 08596730ec1f0d04034fa87f63daa8b78ca306d3 | no | 26 |
| Warnings: | | | | | |
| Information: | | | | | |
| 28 | Foreign Reference | FP13_JP2003330613A_MachineTrans_EFS.pdf | 784316 80c318a10389da4885958139dd772ca0efe2d3dd | no | 39 |
| Warnings: | | | | | |
| Information: | | | | | |

| | | | | | |
|---------------------|-------------------|--|---|----|----|
| 29 | Foreign Reference | FP14_JP2005234199_MachineT rans_EFS.pdf | 269197 d759ea672d24000a8ecc9927e9ff05b2adfd 325b | no | 14 |
| Warnings: | | | | | |
| Information: | | | | | |
| 30 | Foreign Reference | FP14_JP2005234199A_Abstrac t_EFS.pdf | 84299 b650017ff8d72180a96e1c763180cf66e002 aa09 | no | 2 |
| Warnings: | | | | | |
| Information: | | | | | |
| 31 | Foreign Reference | FP14_JP2005234199A_EFS.pdf | 870491 5871420407f9b398f38d8fd234a6935442cd 077b | no | 14 |
| Warnings: | | | | | |
| Information: | | | | | |
| 32 | Foreign Reference | FP15_JPH03271976A_Abstrac t_EFS.pdf | 95170 f281894a30841953a6dde3758fffa535fa8ae d98 | no | 2 |
| Warnings: | | | | | |
| Information: | | | | | |
| 33 | Foreign Reference | FP15_JPH03271976A_EFS.pdf | 7539284 3b43c7bb15b36f54979bb12ac19ff3312eb 794b8 | no | 30 |
| Warnings: | | | | | |
| Information: | | | | | |
| 34 | Foreign Reference | FP16_JP2003345491.PDF | 728532 4c1cb646da509b7c0ce2c07539ad2873a07 fecaf | no | 9 |
| Warnings: | | | | | |
| Information: | | | | | |
| 35 | Foreign Reference | FP16_JP2003345491_EFS_trans .pdf | 328522 7deea6b311e2408195162171bf17e9a8e1d bc204 | no | 16 |
| Warnings: | | | | | |
| Information: | | | | | |
| 36 | Foreign Reference | FP17_EP2069877_Ab_EFS.pdf | 76612 d84de0c65207a5c300228f1b368155d166f a46d6 | no | 2 |
| Warnings: | | | | | |
| Information: | | | | | |
| 37 | Foreign Reference | FP17_EP2069877_WO2008030 563A2_EFS.pdf | 3912317 58a3186f69a1a6157a68608a61d090eee93 35e6e | no | 47 |
| Warnings: | | | | | |
| Information: | | | | | |

| | | | | | |
|---------------------|-------------------|--|--|----|---|
| 38 | Foreign Reference | FP18_KR20020095992.PDF | 235219 9631f7ef7f0551ff3580b810f8164295a29c7859 | no | 6 |
| Warnings: | | | | | |
| Information: | | | | | |
| 39 | Foreign Reference | FP18_KR20020095992_Ab_EFS.pdf | 72087 44dac1a550c24e21cc9b78b71df18871121b1b2e | no | 1 |
| Warnings: | | | | | |
| Information: | | | | | |
| 40 | Foreign Reference | FP18_KR20020095992_English_Translation_efs.pdf | 723507 c28cfe0ac53d3c6387007220371284e8856c90b | no | 6 |
| Warnings: | | | | | |
| Information: | | | | | |
| 41 | Foreign Reference | FP19_KR20020038177A_Abstract_EFS.pdf | 72857 636aaf5757ad59cff6612eaa41ef5ac25f60274a | no | 1 |
| Warnings: | | | | | |
| Information: | | | | | |
| 42 | Foreign Reference | FP19_KR20020038177A_EFS.pdf | 389132 7fc3b3dd70d888cfd0abd70c9de77f1849fb5069 | no | 9 |
| Warnings: | | | | | |
| Information: | | | | | |
| 43 | Foreign Reference | FP19_1020000068238_English_Translation_efs.pdf | 780743 0045f6b63c6c7d21a7ea8138db7c022477f892ea | no | 8 |
| Warnings: | | | | | |
| Information: | | | | | |
| 44 | Foreign Reference | FP20_KR20020081953A_Abstract_EFS.pdf | 70840 38ef125c1126956f2d965f1ca2bb7751bc2fc929 | no | 1 |
| Warnings: | | | | | |
| Information: | | | | | |
| 45 | Foreign Reference | FP20_KR20020081953A_EFS.pdf | 384810 f586cbd3d89938033ff1b15e1ee7c17b33e32b8e | no | 8 |
| Warnings: | | | | | |
| Information: | | | | | |
| 46 | Foreign Reference | FP20_1020010021595_English_Translation_efs.pdf | 850674 3c10f1ce2716708c90f5d5da461e6fe98f89347f | no | 7 |
| Warnings: | | | | | |
| Information: | | | | | |

| | | | | | |
|---------------------|-------------------|------------------------|---|----|-----|
| 47 | Foreign Reference | FP21_WO9429788.pdf | 1784319 06da80b1d2f7d280a3c7681f9fb18f816976b51 | no | 46 |
| Warnings: | | | | | |
| Information: | | | | | |
| 48 | Foreign Reference | FP22_WO9806054.pdf | 8352485 507f915aeac1cd75d8f048fe47b23d37afca91b6 | no | 221 |
| Warnings: | | | | | |
| Information: | | | | | |
| 49 | Foreign Reference | FP23_WO9807112A2.pdf | 983483 8466a9b0211509267306015c8f21e846f22ea47a | no | 32 |
| Warnings: | | | | | |
| Information: | | | | | |
| 50 | Foreign Reference | FP24_WO1999_28812.pdf | 1068914 bbd9026e8f741ee5d5978e890418a385d81ef1ae | no | 32 |
| Warnings: | | | | | |
| Information: | | | | | |
| 51 | Foreign Reference | FP25_WO1999_57630.pdf | 991720 41118da5107b15c515587d5b31cb422feb092225 | no | 24 |
| Warnings: | | | | | |
| Information: | | | | | |
| 52 | Foreign Reference | FP26_WO01029702.pdf | 642292 7b11c804df3abd2fc0de012a3129b13caec72e5e | no | 12 |
| Warnings: | | | | | |
| Information: | | | | | |
| 53 | Foreign Reference | FP27_WO200208881.pdf | 1193638 9f8d61e142c4c8cc64ad5b254a68a97b38bd73b1 | no | 30 |
| Warnings: | | | | | |
| Information: | | | | | |
| 54 | Foreign Reference | FP28_WO2008_030563.pdf | 1193639 c18eff9c5ba1d4a443a8c27ec85c11452061bd0e | no | 30 |
| Warnings: | | | | | |
| Information: | | | | | |
| 55 | Foreign Reference | FP29_WO2008_086218.pdf | 4433131 4347f4fd5c32c906d5abe159434e9fa2fbc55cd2 | no | 107 |
| Warnings: | | | | | |
| Information: | | | | | |

| | | | | | |
|---|-------------------|-----------------------------|--|----------|----|
| 56 | Foreign Reference | FP30_WO2011_045805.pdf | 743573 005f3bf332f75dfad21700a5a85b056db22c406a | no | 21 |
| Warnings: | | | | | |
| Information: | | | | | |
| 57 | Foreign Reference | FP31_FR2830093A3_EFS.pdf | 818413 3c1d1a17e7e816c47465c5b93289bd37b6c048be | no | 11 |
| Warnings: | | | | | |
| Information: | | | | | |
| 58 | Foreign Reference | FP32_JPA_H02-140822_EFS.pdf | 428818 69970a47cd4a3edbeddf1ec5df06b40d3cb1dfe | no | 5 |
| Warnings: | | | | | |
| Information: | | | | | |
| 59 | Foreign Reference | FP33_JPA_H07-230352_EFS.pdf | 849275 c23a378f16ffcf17b9e6cd2761839dc829dc39f | no | 35 |
| Warnings: | | | | | |
| Information: | | | | | |
| 60 | Foreign Reference | FP34_JPA_H11-126149_EFS.pdf | 294800 b1cd033fe4b59ab534909e2695bae4802b7f6f26 | no | 9 |
| Warnings: | | | | | |
| Information: | | | | | |
| Total Files Size (in bytes): | | | | 60302916 | |
| <p>This Acknowledgement Receipt evidences receipt on the noted date by the USPTO of the indicated documents, characterized by the applicant, and including page counts, where applicable. It serves as evidence of receipt similar to a Post Card, as described in MPEP 503.</p> <p><u>New Applications Under 35 U.S.C. 111</u> If a new application is being filed and the application includes the necessary components for a filing date (see 37 CFR 1.53(b)-(d) and MPEP 506), a Filing Receipt (37 CFR 1.54) will be issued in due course and the date shown on this Acknowledgement Receipt will establish the filing date of the application.</p> <p><u>National Stage of an International Application under 35 U.S.C. 371</u> If a timely submission to enter the national stage of an international application is compliant with the conditions of 35 U.S.C. 371 and other applicable requirements a Form PCT/DO/EO/903 indicating acceptance of the application as a national stage submission under 35 U.S.C. 371 will be issued in addition to the Filing Receipt, in due course.</p> <p><u>New International Application Filed with the USPTO as a Receiving Office</u> If a new international application is being filed and the international application includes the necessary components for an international filing date (see PCT Article 11 and MPEP 1810), a Notification of the International Application Number and of the International Filing Date (Form PCT/RO/105) will be issued in due course, subject to prescriptions concerning national security, and the date shown on this Acknowledgement Receipt will establish the international filing date of the application.</p> | | | | | |

| | | | | | | | |
|--|---|---------------------------|----|--|---------------------------------|---------------------|--|
| INFORMATION DISCLOSURE CITATION Substitute for Form 1449-PTO | | | | Electronically filed January 15, 2013 | | | |
| | | | | Application Number | | 90/012,304 | |
| | | | | Filing Date | | May 23, 2012 | |
| | | | | First Named Inventor | | Bas Ordning | |
| | | | | Art Unit | | 3992 | |
| Examiner Name | | BONSHOCK, DENNIS G | | | | | |
| Sheet | 1 | of | 13 | Attorney Docket Number | P4304USREX2/120730-002US | | |

| U.S. PATENT DOCUMENTS | | | | | |
|-----------------------|-----------------------|---------------------------------|--------------------------------|--|---|
| Examiner Initials | Cite No. ¹ | Document Number | Publication Date MM-DD-YYYY | Name of Patentee or Applicant of Cited Document | Pages, Columns, Lines, Where Relevant Passages or Relevant Figures Appear |
| | | Number - Kind Code ² | | | |
| | US 1 | 6,920,619 | 07-19-2005 | Milekic | |
| | US 2 | 6,188,391 | 02-13-2001 | Seely et al. | |
| | US 3 | 6,570,594 | 05-27-2003 | Wagner | |
| | | | | | |

| U.S. PATENT APPLICATION DOCUMENTS | | | | | |
|-----------------------------------|-----------------------|---------------------------------|--------------------------------|--|---|
| Examiner Initials | Cite No. ¹ | Document Number | Publication Date MM-DD-YYYY | Name of Patentee or Applicant of Cited Document | Pages, Columns, Lines, Where Relevant Passages or Relevant Figures Appear |
| | | Number - Kind Code ² | | | |
| | USA 1 | 2004/0160458 | 02-09-2004 | Igarashi et al. | |
| | USA 2 | 2002/0180763 | 12-05-2002 | Kung | |
| | USA 3 | 2005/0195154 | 09-08-2005 | Robbins et al. | |
| | USA 4 | 2005/0183026 | 08-18-2005 | Amano et al. | |
| | USA 5 | 2006/0026521 | 02-02-2006 | Hotelling et al. | |
| | USA 6 | 2004/0205504 | 10-14-2004 | Phillips | |
| | USA 7 | 2006/0001652 | 01-05-2006 | Chiu et al. | |
| | USA 8 | 2004/0125088 | 07-01-2004 | Zimmerman | |
| | USA 9 | 2009/0284478 | 11-19-2009 | De La Torre et al. | |
| | USA 10 | 2008/0013826 | 01-17-2008 | Hillis et al. | |
| | | | | | |
| | | | | | |

| FOREIGN PATENT DOCUMENTS | | | | | | |
|--------------------------|----------|---|--------------------------------|---|---|----------------|
| Examiner Initials | Cite No. | Foreign Patent Document | Publication Date MM-DD-YYYY | Name of Patentee or Applicant of Cited Document | Pages, Columns, Lines, Where Relevant Passages or Relevant Figures Appear | T ⁶ |
| | | Country Code ³ - Number ⁴ - Kind Code ⁵ (if known) | | | | |
| | FP 1 | CN 1754141 | 03-01-2006 | Mulligan et al. | | |
| | FP 2 | DE 102008 052485 | 04-22-2010 | Hohne | | |
| | FP 3 | EP 0944218 | 09-22-1999 | Ringot | | |

| | | | |
|--------------------|--|-----------------|--|
| Examiner Signature | | Date Considered | |
|--------------------|--|-----------------|--|

*EXAMINER: Initial if reference considered, whether or not citation is in conformance with MPEP 609. Draw line through citation if not in conformance and not considered. Include copy of this form with next communication to applicant. ¹ Applicant's unique citation designation number (optional). ² See Kind Codes of USPTO Patent Documents at www.uspto.gov or MPEP 901.04. ³ Enter Office that issued the document, by the two-letter code (WIPO Standard ST.3). ⁴ For Japanese patent documents, the indication of the year of the reign of the Emperor must precede the serial number of the patent document. ⁵ Kind of document by the appropriate symbols as indicated on the document under WIPO Standard ST. 16 if possible. ⁶ Applicant is to place a check mark here if English language Translation is attached.

Burden Hour Statement: This form is estimated to take 2.0 hours to complete. Time will vary depending upon the needs of the individual case. Any comments on the amount of time you are required to complete this form should be sent to the Chief Information Officer, U.S. Patent and Trademark Office, Washington, DC 20231. DO NOT SEND FEES OR COMPLETED FORMS TO THIS ADDRESS. SEND TO: Assistant Commissioner for Patents, P.O. Box 1450, Alexandria, VA 22313-1450.

| | | | | | | | |
|--|---|----|----|--|--|---------------------------------|--|
| INFORMATION DISCLOSURE CITATION Substitute for Form 1449-PTO | | | | <i>Electronically filed January 15, 2013</i> | | | |
| | | | | Application Number | | 90/012,304 | |
| | | | | Filing Date | | May 23, 2012 | |
| | | | | First Named Inventor | | Bas Ordning | |
| | | | | Art Unit | | 3992 | |
| | | | | Examiner Name | | BONSHOCK, DENNIS G | |
| Sheet | 2 | of | 13 | Attorney Docket Number | | P4304USREX2/120730-002US | |

| | | | | | | |
|--|-------|-----------------|------------|------------------------|--|---|
| | FP 4 | EP 0725 331 | 07-08-1996 | Tae | | |
| | FP 5 | EP 1517228 | 03-01-2005 | Hill | | |
| | FP 6 | EP 2102738 | 07-17-2008 | Platzer et al. | | |
| | FP 7 | GB 2319591 | 05-27-1998 | Sato et al. | | |
| | FP 8 | JP 1999/126149 | 05-11-1999 | Miwa | | X |
| | FP 9 | JP 2000/163031 | 06-16-2000 | Yasuhiro et al. | | X |
| | FP 10 | JP 2000/322495 | 11-24-2000 | Toshiyuki | | X |
| | FP 11 | JP 2002/254614 | 09-11-2002 | Yasushi | | X |
| | FP 12 | JP 2002/342033 | 11-29-2002 | Rekimoto | | X |
| | FP 13 | JP 2003/330613 | 11-21-2003 | Kuniaki | | X |
| | FP 14 | JP 2005/234199 | 09-02-2005 | Daigo | | X |
| | FP 15 | JP H03-271976 | 03-12-1991 | Kurosawa Yoshiaki | | |
| | FP 16 | JP 2003-345491 | 12-05-2003 | Shuichi | | X |
| | FP 17 | EP 2069877 | 03-13-2008 | Ligtenberg | | |
| | FP 18 | KR 2002-0095992 | 12-28-2002 | Ryu Hyeok Gon | | X |
| | FP 19 | KR 2002-0038177 | 05-23-2002 | Yeong | | X |
| | FP 20 | KR 2002-0081953 | 10-30-2002 | Kim Yong Bok | | X |
| | FP 21 | WO 94/29788 | 12-22-1994 | Staggs et al. | | |
| | FP 22 | WO 98/06054 | 02-12-1998 | Huffman et al. | | |
| | FP 23 | WO 1998/07112 | 02-19-1998 | Gill | | |
| | FP 24 | WO 1999/28812 | 06-10-1999 | Northern Telecom | | |
| | FP 25 | WO 1999/57630 | 11-11-1999 | Scientific Atlanta | | |
| | FP 26 | WO 01/029702 | 04-26-2001 | Van Den Hoven | | |
| | FP 27 | WO 2002/08881 | 01-31-2002 | Worthington et al. | | |
| | FP 28 | WO 2008/030563 | 03-13-2008 | Ligtenberg | | |
| | FP 29 | WO 2008/086218 | 07-17-2008 | Ordning | | |
| | FP 30 | WO 2011/045805 | 04-21-2011 | Dey et al. | | |
| | FP 31 | FR 2830093 | 03-28-2003 | Benoit | | |
| | FP 32 | JPA H02-140822 | 05-30-1990 | Izeki Osamu | | X |
| | FP 33 | JPA H07-230352 | 08-29-1995 | Kamimura Toshio et al. | | X |
| | FP 34 | JPA H11-126149 | 05-11-1999 | Iketa Satoshi | | X |
| | FP 35 | JPA H11-327733 | 11-30-1999 | Miyazaki Koichi | | X |
| | FP 36 | JPA H10-240220 | 09-11-1998 | Nagae Hisayoshi | | X |
| | FP 37 | JPA 2003-344059 | 12-03-2003 | Ito Masahiro | | X |
| | FP 38 | JPA 2001-290585 | 10-19-2001 | Wakai Masanori | | X |

| | | | |
|-----------------------|--|--------------------|--|
| Examiner Signature | | Date Considered | |
|-----------------------|--|--------------------|--|

*EXAMINER: Initial if reference considered, whether or not citation is in conformance with MPEP 609. Draw line through citation if not in conformance and not considered. Include copy of this form with next communication to applicant. ¹ Applicant's unique citation designation number (optional). ² See Kind Codes of USPTO Patent Documents at www.uspto.gov or MPEP 901.04. ³ Enter Office that issued the document, by the two-letter code (WIPO Standard ST.3). ⁴ For Japanese patent documents, the indication of the year of the reign of the Emperor must precede the serial number of the patent document. ⁵ Kind of document by the appropriate symbols as indicated on the document under WIPO Standard ST. 16 if possible. ⁶ Applicant is to place a check mark here if English language Translation is attached.

Burden Hour Statement: This form is estimated to take 2.0 hours to complete. Time will vary depending upon the needs of the individual case. Any comments on the amount of time you are required to complete this form should be sent to the Chief Information Officer, U.S. Patent and Trademark Office, Washington, DC 20231. DO NOT SEND FEES OR COMPLETED FORMS TO THIS ADDRESS. SEND TO: Assistant Commissioner for Patents, P.O. Box 1450, Alexandria, VA 22313-1450.

| | | | | | | |
|--|--------------------|----|----|--|--------------------------|--|
| INFORMATION DISCLOSURE CITATION Substitute for Form 1449-PTO | | | | <i>Electronically filed January 15, 2013</i> | | |
| | | | | Application Number | 90/012,304 | |
| | | | | Filing Date | May 23, 2012 | |
| | | | | First Named Inventor | Bas Ordning | |
| | | | | Art Unit | 3992 | |
| Examiner Name | BONSHOCK, DENNIS G | | | | | |
| Sheet | 3 | of | 13 | Attorney Docket Number | P4304USREX2/120730-002US | |

| | | | | | | |
|--|-------|-----------------|------------|----------------------|--|---|
| | FP 39 | JPA 2003-288151 | 10-10-2003 | Murakoshi Toshio | | X |
| | FP 40 | JPA 2003-140802 | 05-16-2003 | Sowden Anthony et al | | X |
| | FP 41 | JPA 2005-284726 | 10-13-2005 | Watanabe Tomio et al | | X |
| | FP 42 | GB 2335105 | 08-09-1999 | Pringle | | |
| | FP 43 | WO 03/023593 | 03-20-2003 | Metsavainio et al. | | |
| | FP 44 | KR 2003-0088374 | 11-28-2006 | Kyocera Corp. | | X |
| | FP45 | WO 2008/05848 | 07-17-2008 | Blumenberg | | |
| | FP 46 | JPS63-146168 | 06-18-1988 | Tajima Hiroaki | | |
| | FP 47 | JP2001-318665 | 11-16-2001 | Sakano Keiichi | | X |
| | FP 48 | JP2006-154892A | 06-15-2006 | Ishida Kenichi | | X |
| | FP 49 | JP2006-090962A | 04-06-2006 | Niijima Hiroyuki | | X |
| | FP 50 | JP2005-515530A | 05-26-2005 | Zimmerman | | X |
| | FP 51 | JP2003-108279A | 04-11-2003 | Tokura | | X |
| | FP 52 | JPH10-161628A | 06-19-1998 | Kamata | | X |
| | FP 53 | JPS63-206827A | 08-26-1988 | Asami Toshihiro | | |
| | FP 54 | JPH9-237175A | 09-09-1997 | Sawai Tetsuji | | X |
| | FP 55 | JPH8-249114A | 09-27-1996 | Tanaka Satoshi | | X |
| | FP 56 | JPH5-100809A | 04-23-1993 | Mizuguchi Tamotsu | | X |
| | FP 57 | JP2000-181428A | 06-30-2000 | Kato Kiyosh | | X |
| | FP 58 | JP2005-267631A | 09-29-2005 | Robertson George | | X |
| | FP 59 | JPH7-182134A | 07-21-1995 | Nashiki Noboru | | X |
| | FP 60 | JP2004-310388A | 11-04-2004 | Shimizu Hideyuk | | X |
| | FP 61 | JP2000-333044A | 11-30-2000 | Miama Masaki | | X |
| | FP 62 | JP2006-244353A | 09-14-2006 | Murayama Takanori | | X |
| | FP 63 | JP2006-179006A | 07-06-2006 | Kolmykov-Zotov | | X |
| | | | | | | |
| | | | | | | |
| | | | | | | |
| | | | | | | |
| | | | | | | |
| | | | | | | |
| | | | | | | |
| | | | | | | |
| | | | | | | |
| | | | | | | |
| | | | | | | |
| | | | | | | |
| | | | | | | |
| | | | | | | |
| | | | | | | |

| | | | |
|-----------------------|--|--------------------|--|
| Examiner Signature | | Date Considered | |
|-----------------------|--|--------------------|--|

*EXAMINER: Initial if reference considered, whether or not citation is in conformance with MPEP 609. Draw line through citation if not in conformance and not considered. Include copy of this form with next communication to applicant. ¹ Applicant's unique citation designation number (optional). ² See Kind Codes of USPTO Patent Documents at www.uspto.gov or MPEP 901.04. ³ Enter Office that issued the document, by the two-letter code (WIPO Standard ST.3). ⁴ For Japanese patent documents, the indication of the year of the reign of the Emperor must precede the serial number of the patent document. ⁵ Kind of document by the appropriate symbols as indicated on the document under WIPO Standard ST. 16 if possible. ⁶ Applicant is to place a check mark here if English language Translation is attached.

Burden Hour Statement: This form is estimated to take 2.0 hours to complete. Time will vary depending upon the needs of the individual case. Any comments on the amount of time you are required to complete this form should be sent to the Chief Information Officer, U.S. Patent and Trademark Office, Washington, DC 20231. DO NOT SEND FEES OR COMPLETED FORMS TO THIS ADDRESS. SEND TO: Assistant Commissioner for Patents, P.O. Box 1450, Alexandria, VA 22313-1450.

| | | | | | | | |
|--|---|----|----|--|--|---------------------------------|--|
| INFORMATION DISCLOSURE CITATION Substitute for Form 1449-PTO | | | | Electronically filed January 15, 2013 | | | |
| | | | | Application Number | | 90/012,304 | |
| | | | | Filing Date | | May 23, 2012 | |
| | | | | First Named Inventor | | Bas Ording | |
| | | | | Art Unit | | 3992 | |
| | | | | Examiner Name | | BONSHOCK, DENNIS G | |
| Sheet | 4 | of | 13 | Attorney Docket Number | | P4304USREX2/120730-002US | |

| NON PATENT LITERATURE DOCUMENTS | | |
|---------------------------------|----------|--|
| Examiner Initials | Cite No. | Include name of the author (in CAPITAL LETTERS), title of the article (when appropriate), title of the item (book, magazine, journal, serial, symposium, catalog, etc.), date, page(s), volume-issue number(s), publisher, city and/or country where published |
| | NPL 1 | AGARAWALA, A., "Enriching the Desktop Metaphor with Physics, Piles and Pen," 2006, pp.10-101 |
| | NPL 2 | AGARAWALA, A. et al., "Keepin' It Real: Pushing the Desktop Metaphor with Physics, Piles and the Pen," CHI 2006, April 22-27, 2006, Montreal, Canada |
| | NPL 3 | BACH, M.J., The Design of the Unix Operating System, Eastern Economy Edition, 1986 |
| | NPL 4 | BAECKER et al., Reading in Human-Computer Interaction: A Multidisciplinary Approach, 1987 |
| | NPL 5 | BAECKER et al., Readings in Human-Computer Interaction: Toward the Year 2000, 1995 |
| | NPL 6 | Website (Tech On) |
| | NPL 7 | BEDERSON et al., "Pad++: A Zooming Graphical Interface for Exploring Alternate Interface Physics," UIST '94 Proceedings of the 7th annual ACM symposium on User Interface Software and Technology, November 2-4, 1994, pp.17-26 |
| | NPL 8 | BEDERSON et al., "Jazz: An Extensible Zoomable User Interface Graphics Toolkit in Java," ACM symposium on User Interfaces Software and Technology, May 2000 |
| | NPL 9 | BEDERSON et al., "Jazz: An Extensible 2D+ Zooming Graphics Toolkit in Java," July 1999 |
| | NPL 10 | BIC et al., The Logical Design of Operating Systems, Second Edition, 1988, pp. 1-370 |
| | NPL 11 | BIER, E., "Snap-Dragging: Interactive Geometric Design in Two and Three Dimensions," Ph.D. Thesis, University of California, Berkeley, 1989 |
| | NPL 12 | BIER et al., "Snap-Dragging," Proceedings of SIGGRAPH 86, Computer Graphics (20) 4, 1986, pp. 233-240 |
| | NPL 13 | BORMAN et al., Human Factors in Computing Systems, CHI '85 Conference Proceedings, April 14-18, 1985, San Francisco |
| | NPL 14 | BROWNE, H. et al., "Designing a Collaborative Finger Painting Application for Children," UM Computer Science Department; CS-TR-4184; 2000 |
| | NPL 15 | <i>The Technical System of Personal Computer 2000</i> |
| | NPL 16 | BUXTON, W., "Invited Paper: A Touching Story: A Personal Perspective on the History of Touch Interfaces Past and Future," Society for Information Display (SID) Symposium Digest of Technical Papers, May 2010, pp. 444-448, Volume 41(1), Session 31 |
| | NPL 17 | CHANG et al., "Animation: From Cartoons to the User Interface," UIST '93 Proceedings of the 6th annual ACM symposium on User Interface Software and Technology, 1993, pp. 1-18 |

| | |
|--------------------|-----------------|
| Examiner Signature | Date Considered |
|--------------------|-----------------|

*EXAMINER: Initial if reference considered, whether or not citation is in conformance with MPEP 609. Draw line through citation if not in conformance and not considered. Include copy of this form with next communication to applicant. ¹ Applicant's unique citation designation number (optional). ² See Kind Codes of USPTO Patent Documents at www.uspto.gov or MPEP 901.04. ³ Enter Office that issued the document, by the two-letter code (WIPO Standard ST.3). ⁴ For Japanese patent documents, the indication of the year of the reign of the Emperor must precede the serial number of the patent document. ⁵ Kind of document by the appropriate symbols as indicated on the document under WIPO Standard ST. 16 if possible. ⁶ Applicant is to place a check mark here if English language Translation is attached.

Burden Hour Statement: This form is estimated to take 2.0 hours to complete. Time will vary depending upon the needs of the individual case. Any comments on the amount of time you are required to complete this form should be sent to the Chief Information Officer, U.S. Patent and Trademark Office, Washington, DC 20231. DO NOT SEND FEES OR COMPLETED FORMS TO THIS ADDRESS. SEND TO: Assistant Commissioner for Patents, P.O. Box 1450, Alexandria, VA 22313-1450.

| | | | | | | |
|--|---------------------------|----|------------------------|--|---------------------|--|
| INFORMATION DISCLOSURE CITATION Substitute for Form 1449-PTO | | | | <i>Electronically filed January 15, 2013</i> | | |
| | | | | Application Number | 90/012,304 | |
| | | | | Filing Date | May 23, 2012 | |
| | | | | First Named Inventor | Bas Ordning | |
| | | | | Art Unit | 3992 | |
| Examiner Name | BONSHOCK, DENNIS G | | Attorney Docket Number | P4304USREX2/120730-002US | | |
| Sheet | 5 | of | 13 | | | |

| | |
|--------|---|
| NPL 18 | Communication Arts, 2006 September/October Communication Arts Interactive Annual 12 |
| NPL 19 | Communication Arts, 2005 September/ October Communication Arts Interactive Annual 11 |
| NPL 20 | Communication Arts, 2004 September/ October Communication Arts Interactive Annual 10 |
| NPL 21 | Communication Arts, 2003 September/ October Communication Arts Interactive Annual 9 |
| NPL 22 | Communication Arts, 2001 September/ October Communication Arts Interactive Annual 7 |
| NPL 23 | Wireless News, "Adobe Rolls Out Flash Player 9," June 28, 2006 |
| NPL 24 | DENNING, P.J., The Invisible Future, 2001 |
| NPL 25 | ZUKOWSKI, J., Java AWT Reference (Java 1.1) |
| NPL 26 | ED. C. EPP, Prelude to Patterns in Computer Science Using Java, Beta Edition, 2001 |
| NPL 27 | ERICKSON, T.D., Working with Interface Metaphors, in Human-computer Interaction, 1995, pp.65-73 |
| NPL 28 | Flash to the Core Website (http://flashtothecore.praystation.com/), 2002 |
| NPL 29 | Flashloaded SlideMem Website, (http://flashloaded.com/flashcomponents/slidemem/), 2007 |
| NPL 30 | D. Patel et al. "Improving Photo Searching Interfaces for Small-screen Mobile Computers" in Proceedings Mobile HCI 2006, ACM Press, pp 149-156 (Sep. 2006) |
| NPL 31 | FOLEY et al., Computer Graphics- Principles and Practice, 2nd Edition in C, 1996 |
| NPL 32 | FOLEY et al., Computer Graphics- Principles and Practice, 2nd Edition, 1990 |
| NPL 33 | FOLEY et al., Introduction to Computer Graphics, 1994 |
| NPL 34 | GLEICHER, M., "Image Snapping," 1995, pp.183-190 |
| NPL 35 | GROSS, MARK D., "Grids in Design and CAD," Proceedings of Association for Computer Aided Design in Architecture, 1991, pp.1-11 |
| NPL 36 | Hewlett-Packard, User's Guide-HP iPAQ Pocket PC h1900 series, May 2003 |
| NPL 37 | Hewlett-Packard, QuickSpecs-HP iPAQ rx1950 Pocket PC, September, 26, 2005 |
| NPL 38 | ISHAK et al., "Content-Aware Scrolling," UIST'06 Proceedings of the 19th annual ACM symposium on User Interface Software and Technology, October 15-18, 2006, Montrex, Switzerland |
| NPL 39 | JOHNSON, J. et al., "The Effect of Touch-Pad Size on Pointing Accuracy," April 1994, pp.1-8 |
| NPL 40 | JOHNSON, J. et al., "A Comparison of User Interfaces for Panning on a Touch-Controlled Display," CHI '95 Proceedings of the SIGCHI Conference on Human Factors in Computing Systems, Mosaic of Creativity, May 1995, pp.1-8 |
| NPL 41 | JOHNSON, J. et al., A Collection of Papers from FirstPerson, Inc., 1995, pp. 1-86 |

| | | | |
|--------------------|--|-----------------|--|
| Examiner Signature | | Date Considered | |
|--------------------|--|-----------------|--|

*EXAMINER: Initial if reference considered, whether or not citation is in conformance with MPEP 609. Draw line through citation if not in conformance and not considered. Include copy of this form with next communication to applicant. ¹ Applicant's unique citation designation number (optional). ² See Kind Codes of USPTO Patent Documents at www.uspto.gov or MPEP 901.04. ³ Enter Office that issued the document, by the two-letter code (WIPO Standard ST.3). ⁴ For Japanese patent documents, the indication of the year of the reign of the Emperor must precede the serial number of the patent document. ⁵ Kind of document by the appropriate symbols as indicated on the document under WIPO Standard ST. 16 if possible. ⁶ Applicant is to place a check mark here if English language Translation is attached.

Burden Hour Statement: This form is estimated to take 2.0 hours to complete. Time will vary depending upon the needs of the individual case. Any comments on the amount of time you are required to complete this form should be sent to the Chief Information Officer, U.S. Patent and Trademark Office, Washington, DC 20231. DO NOT SEND FEES OR COMPLETED FORMS TO THIS ADDRESS. SEND TO: Assistant Commissioner for Patents, P.O. Box 1450, Alexandria, VA 22313-1450.

| | | | | | | | |
|--|---|----|----|--|--|---------------------------------|--|
| INFORMATION DISCLOSURE CITATION Substitute for Form 1449-PTO | | | | <i>Electronically filed January 15, 2013</i> | | | |
| | | | | Application Number | | 90/012,304 | |
| | | | | Filing Date | | May 23, 2012 | |
| | | | | First Named Inventor | | Bas Ordning | |
| | | | | Art Unit | | 3992 | |
| | | | | Examiner Name | | BONSHOCK, DENNIS G | |
| Sheet | 6 | of | 13 | Attorney Docket Number | | P4304USREX2/120730-002US | |

| | |
|--------|--|
| NPL 42 | JOHNSON, E.A., "Touch Displays: A Programmed Man-Machine Interface," Ergonomics, March 1967, pp. 271-277, Volume 10, Number 2 |
| NPL 43 | KARLSON et al., AppLens and LaunchTile: Two Designs for One-Handed Thumb Use on Small Devices," CHI 2005 (Powerpoint), 2005 |
| NPL 44 | KROLIK, M., PIV Creator 3.41, Cross Browser DHTML 360 Panorama Image Viewer (PIV), 1999 |
| NPL 45 | KRUEGER, M.W., Artificial Reality, 1983 |
| NPL 46 | KRUEGER, M.W., Artificial Reality II, 1991 |
| NPL 47 | LAUREL, B., The Art of Human-Computer Interface Design, 1990, pp.65-73 |
| NPL 48 | LEE, S.K. et al., "A Multi-Touch Three Dimensional Touch-Sensitive Tablet," CHI '85 Proceedings, April 1985, pp. 21-25 |
| NPL 49 | LEWIS et al., MAC OS In A Nutshell- A Power User's Quick Reference, 2000 |
| NPL 50 | MASUI et al., "Elastic Graphical Interfaces for Precise Data Manipulation," ACM Conference on Human Factors in Computing Systems (CHI '95) Conference Companion, April 1995, pp. 143-144 |
| NPL 51 | D. Patel et al., "An Evaluation of Techniques for Browsing Photograph Collections on Small Displays", Proceedings Mobile HCI 2004, pp. 132-143 |
| NPL 52 | NORMAN et al., User Centered System Design, 1986 |
| NPL 53 | A. Cockburn and J. Savage, "Comparing Speed-Dependent Automatic Zooming with Traditional Scroll, Pan, and Zoom Methods", in People and Computers XVII: British Computer Society Conference on Human Computer Interaction, 2003, p.87-102 |
| NPL 54 | OWEN, G.S., Principles of Animation: Slow In and Out, March 13, 1999 |
| NPL 55 | PETZOLD, C., Programming Windows, 5th Edition, 1999 |
| NPL 56 | PlasmaplugsScrollBar Website, 2006 |
| NPL 57 | ROBERTSON et al., "Data Mountain: Using Spatial Memory for Document Management," UIST '98: Proceedings of the 11th Annual ACM symposium on User Interface Software and Technology, San Francisco, 1998, pp. 153-162. |
| NPL 58 | RUBINE, D., "Combining Gestures & Direct Manipulation," CHI '92, May 3-7, 1992, pp. 659-660 |
| NPL 59 | RUBINE et al., "The VideoHarp," ICMC Proceedings 1988, pp.49-55 |
| NPL 60 | SHNEIDERMAN, B., "Direct Manipulation: A Step Beyond Programming Languages," Aug. 1983, pp. 57-69, Computer, Vol. 16(8) |
| NPL 61 | P. Eslambolchilar and R. Murray-Smith, "Tilt-based automatic zooming and scaling in mobile devices – A state-space implementation." Mobile Human-Computer Interaction – MobileHCI 2004: 6th International Symposium, Glasgow, UK, September 13 - 16, 2004, pp. 120-131 |

| | |
|--------------------|-----------------|
| Examiner Signature | Date Considered |
|--------------------|-----------------|

*EXAMINER: Initial if reference considered, whether or not citation is in conformance with MPEP 609. Draw line through citation if not in conformance and not considered. Include copy of this form with next communication to applicant. ¹ Applicant's unique citation designation number (optional). ² See Kind Codes of USPTO Patent Documents at www.uspto.gov or MPEP 901.04. ³ Enter Office that issued the document, by the two-letter code (WIPO Standard ST.3). ⁴ For Japanese patent documents, the indication of the year of the reign of the Emperor must precede the serial number of the patent document. ⁵ Kind of document by the appropriate symbols as indicated on the document under WIPO Standard ST. 16 if possible. ⁶ Applicant is to place a check mark here if English language Translation is attached.

Burden Hour Statement: This form is estimated to take 2.0 hours to complete. Time will vary depending upon the needs of the individual case. Any comments on the amount of time you are required to complete this form should be sent to the Chief Information Officer, U.S. Patent and Trademark Office, Washington, DC 20231. DO NOT SEND FEES OR COMPLETED FORMS TO THIS ADDRESS. SEND TO: Assistant Commissioner for Patents, P.O. Box 1450, Alexandria, VA 22313-1450.

| | | | | | |
|--|---------------------------|----|----|--|---------------------------------|
| INFORMATION DISCLOSURE CITATION Substitute for Form 1449-PTO | | | | <i>Electronically filed January 15, 2013</i> | |
| | | | | Application Number | 90/012,304 |
| | | | | Filing Date | May 23, 2012 |
| | | | | First Named Inventor | Bas Ording |
| | | | | Art Unit | 3992 |
| Examiner Name | BONSHOCK, DENNIS G | | | | |
| Sheet | 7 | of | 13 | Attorney Docket Number | P4304USREX2/120730-002US |

| | | |
|--|--------|---|
| | NPL 62 | SILBERSCHATZ, A. et al., Operating System Concepts, Third Edition, 1991, pp. 1-696. |
| | NPL 63 | SMITH et al., "The Radial Scroll Tool: Scrolling Support for Stylus- or Touch-Based Document Navigation," UIST '04 Proceedings of the 17th Annual ACM symposium on User Interface Software and Technology, October 24-27, 2004, Santa Fe, New Mexico, pp. 1-4 |
| | NPL 64 | Forlines et al., Glimpse: A Novel Input Model for Multi-Level Devices, Mitsubishi Electric Laboratories, CHI 2005 |
| | NPL 65 | Sony, "The Power of a Full-Sized PC in the Palm of your Hand," 2004 |
| | NPL 66 | SUN et al., "Flipper: A New Method of Digital Document Navigation," CHI '05 extended abstracts on Human factors in computing systems, April 2-7, 2005, Portland, Oregon, pp.2001-2004 |
| | NPL 67 | Teleprompter-VBForums, 2003 |
| | NPL 68 | THOMAS, B.H., Thomas Dissertation-Animating Direct Manipulation in Human Computer Interfaces, 1997, pp. 1-207 |
| | NPL 69 | THOMAS et al., "Animating Direct Manipulation Interfaces," UIST 95 Pittsburg, PA, Nov. 1995, pp. 3-12 |
| | NPL 70 | TIDWELL, J., Designing Interfaces, 2006 |
| | NPL 71 | TOGNAZZINI, B., The "Starfire" Video Prototype Project: A Case History, 1994 |
| | NPL 72 | Apple Inc. v. Samsung Electronics Co., Case no. 11-cv-01846 (N.D. Cal.), excerpts from Apple's Reply Brief in PI Appeal |
| | NPL 73 | Affidavit of Benjamin Bederson, dated February 9, 2012 |
| | NPL 74 | Apple Inc. v. Samsung Electronics Co., Case no. 11-cv-01846 (N.D. Cal.), declaration of Ravin Balakrishnan in support of Apple's opposition to MSJ |
| | NPL 75 | Apple Inc. v. Samsung Electronics Co., Case no. 11-cv-01846 (N.D. Cal.), excerpts from Apple's opposition to Samsung MSJ, filed May 31, 2012 |
| | NPL 76 | Apple Inc. v. Samsung Electronics Co., Case no. 11-cv-01846 (N.D. Cal.), excerpts from Samsung motion for summary judgment, filed May 17, 2012 |
| | NPL 77 | Apple Inc. v. Samsung Electronics Co., Case no. 11-cv-01846 (N.D. Cal.), excerpts from Samsung brief, appealing PI ruling, dated January 11, 2012 |
| | NPL 78 | Apple Inc. v. Samsung Electronics Co., Case no. 11-cv-01846 (N.D. Cal.), reply declaration of Ravin Balakrisnan, filed September 30, 2011 |
| | NPL 79 | Apple Inc. v. Samsung Electronics Co., Case no. 11-cv-01846 (N.D. Cal.), Apple's Opening Claim Construction Brief Pursuant to Patent L.R. 4-5, dated 12-08-2011, pp. 6-8 |
| | NPL 80 | Apple Inc. v. Samsung Electronics Co., Case no. 11-cv-01846 (N.D. Cal.), Apple's Reply Claim Construction Brief Pursuant to Patent L.R. 4-5, dated 12-29-2011, pp. 3-5 |

| | | | |
|--------------------|--|-----------------|--|
| Examiner Signature | | Date Considered | |
|--------------------|--|-----------------|--|

*EXAMINER: Initial if reference considered, whether or not citation is in conformance with MPEP 609. Draw line through citation if not in conformance and not considered. Include copy of this form with next communication to applicant. ¹ Applicant's unique citation designation number (optional). ² See Kind Codes of USPTO Patent Documents at www.uspto.gov or MPEP 901.04. ³ Enter Office that issued the document, by the two-letter code (WIPO Standard ST.3). ⁴ For Japanese patent documents, the indication of the year of the reign of the Emperor must precede the serial number of the patent document. ⁵ Kind of document by the appropriate symbols as indicated on the document under WIPO Standard ST. 16 if possible. ⁶ Applicant is to place a check mark here if English language Translation is attached.

Burden Hour Statement: This form is estimated to take 2.0 hours to complete. Time will vary depending upon the needs of the individual case. Any comments on the amount of time you are required to complete this form should be sent to the Chief Information Officer, U.S. Patent and Trademark Office, Washington, DC 20231. DO NOT SEND FEES OR COMPLETED FORMS TO THIS ADDRESS. SEND TO: Assistant Commissioner for Patents, P.O. Box 1450, Alexandria, VA 22313-1450.

| | | | | | | | |
|--|---|----|----|---|--|---------------------------------|--|
| INFORMATION DISCLOSURE CITATION Substitute for Form 1449-PTO | | | | <i>Electronically filed January 15, 2013</i> | | | |
| | | | | Application Number | | 90/012,304 | |
| | | | | Filing Date | | May 23, 2012 | |
| | | | | First Named Inventor | | Bas Ordning | |
| | | | | Art Unit | | 3992 | |
| | | | | Examiner Name | | BONSHOCK, DENNIS G | |
| Sheet | 8 | of | 13 | Attorney Docket Number | | P4304USREX2/120730-002US | |

| | |
|--------|--|
| NPL 81 | Apple Inc. v. Samsung Electronics Co., Case no. 11-cv-01846 (N.D. Cal.), Order Construing Disputed Claim Terms, dated 04-04-2012 |
| NPL 82 | Apple Inc. v. Samsung Electronics Co., Case no. 11-cv-01846 (N.D. Cal.), Order Construing Disputed Claim Terms of U.S. Patent Nos. 7,469, 381 and 7,864,163, dated 07-20-2012 |
| NPL 83 | Apple Inc. v. Samsung Electronics Co., Case no. 11-cv-01846 (N.D. Cal.), Joint Claim Construction and Prehearing Statement Pursuant to Patent L.R. 4-3, dated 11-14-2011, p. 6 |
| NPL 84 | Apple Inc. v. Samsung Electronics Co., Case no. 11-cv-01846 (N.D. Cal.), Order Denying Motion for Summary Judgment, dated 06-30-2012, pp. 11-17 |
| NPL 85 | U.S. ITC, Investigation No. 337-TA-797, In the Matter of Certain Portable Electronic Devices and Related Software, Expert Report of Ravin Balakrishan, Ph.D. Concerning Claim Construction of U.S. Patent Number 7,469,381, dated 01-18-2012 |
| NPL 86 | U.S. ITC, Investigation No. 337-TA-797, In the Matter of Certain Portable Electronic Devices and Related Software, Respondent's Notice of Prior Art, dated 10-21-2011 |
| NPL 87 | U.S. ITC, Investigation No. 337-TA-797, In the Matter of Certain Portable Electronic Devices and Related Software, Complainant Apple Inc.'s Claim Construction Brief, dated 01-18-2012, pp. 48-70 |
| NPL 88 | U.S. ITC, Investigation No. 337-TA-797, In the Matter of Certain Portable Electronic Devices and Related Software, Joint Motion to Amend the Joint Claim Construction Statement, dated 01-18-2012 |
| NPL 89 | U.S. ITC, Investigation No. 337-TA-797, In the Matter of Certain Portable Electronic Devices and Related Software, Order No. 25: Granting Joint Motion to Amend the Joint Claim Construction Statement, dated 01-19-2012 |
| NPL 90 | U.S. ITC, Investigation No. 337-TA-797, In the Matter of Certain Portable Electronic Devices and Related Software, Notice of Prior Art, dated 11-07-2011 |
| NPL 91 | U.S. ITC, Investigation No. 337-TA-797, In the Matter of Certain Portable Electronic Devices and Related Software, Order No. 57: Construing the Terms of the Asserted Claims of the Patent at Issue, dated 06-26-2012, pp.14-49 |
| NPL 92 | U.S. ITC, Investigation No. 337-TA-797, In the Matter of Certain Portable Electronic Devices and Related Software, Invalidity Exhibit 381-1 |
| NPL 93 | U.S. ITC, Investigation No. 337-TA-797, In the Matter of Certain Portable Electronic Devices and Related Software, Invalidity Exhibit 381-2 |
| NPL 94 | U.S. ITC, Investigation No. 337-TA-797, In the Matter of Certain Portable Electronic Devices and Related Software, Invalidity Exhibit 381-4 |
| NPL 95 | U.S. ITC, Investigation No. 337-TA-797, In the Matter of Certain Portable Electronic Devices and Related Software, Invalidity Exhibit 381-5 |

| | | | |
|--------------------|--|-----------------|--|
| Examiner Signature | | Date Considered | |
|--------------------|--|-----------------|--|

*EXAMINER: Initial if reference considered, whether or not citation is in conformance with MPEP 609. Draw line through citation if not in conformance and not considered. Include copy of this form with next communication to applicant. ¹ Applicant's unique citation designation number (optional). ² See Kind Codes of USPTO Patent Documents at www.uspto.gov or MPEP 901.04. ³ Enter Office that issued the document, by the two-letter code (WIPO Standard ST.3). ⁴ For Japanese patent documents, the indication of the year of the reign of the Emperor must precede the serial number of the patent document. ⁵ Kind of document by the appropriate symbols as indicated on the document under WIPO Standard ST. 16 if possible. ⁶ Applicant is to place a check mark here if English language Translation is attached.

Burden Hour Statement: This form is estimated to take 2.0 hours to complete. Time will vary depending upon the needs of the individual case. Any comments on the amount of time you are required to complete this form should be sent to the Chief Information Officer, U.S. Patent and Trademark Office, Washington, DC 20231. DO NOT SEND FEES OR COMPLETED FORMS TO THIS ADDRESS. SEND TO: Assistant Commissioner for Patents, P.O. Box 1450, Alexandria, VA 22313-1450.

| | | | | | | | |
|--|---|----|----|--|--|---------------------------------|--|
| INFORMATION DISCLOSURE CITATION Substitute for Form 1449-PTO | | | | <i>Electronically filed January 15, 2013</i> | | | |
| | | | | Application Number | | 90/012,304 | |
| | | | | Filing Date | | May 23, 2012 | |
| | | | | First Named Inventor | | Bas Ordning | |
| | | | | Art Unit | | 3992 | |
| | | | | Examiner Name | | BONSHOCK, DENNIS G | |
| Sheet | 9 | of | 13 | Attorney Docket Number | | P4304USREX2/120730-002US | |

| | |
|---------|---|
| NPL 96 | U.S. ITC, Investigation No. 337-TA-797, In the Matter of Certain Portable Electronic Devices and Related Software, Invalidity Exhibit 381-6 |
| NPL 97 | U.S. ITC, Investigation No. 337-TA-797, In the Matter of Certain Portable Electronic Devices and Related Software, Invalidity Exhibit 381-7 |
| NPL 98 | U.S. ITC, Investigation No. 337-TA-797, In the Matter of Certain Portable Electronic Devices and Related Software, Invalidity Exhibit 381-8 |
| NPL 99 | U.S. ITC, Investigation No. 337-TA-797, In the Matter of Certain Portable Electronic Devices and Related Software, Invalidity Exhibit 381-9 |
| NPL 100 | Search information statement dated June 27, 2008, received in Australian Patent Application No. 2008100283, which corresponds to U.S. Application No. 11/956,969, 2 pages. |
| NPL 101 | Decision to grant a European patent, dated September 2, 2010, received in European Patent No. 2059868, which corresponds to U.S. Application No. 11/956,969, 9 pages. |
| NPL 102 | Response to Examiners first report, dated October 21, 2008, received in Australian Patent Application No. 2008100283, which corresponds to U.S. Application No. 11/956,969, 12 pages. |
| NPL 103 | Notice of certification dated November 7, 2008, received in Australian Patent Application No. 2008100283, which corresponds to U.S. Application No. 11/956,969, 1 page. |
| NPL 104 | International Preliminary report on Patentability dated March 10, 2009, received in European Patent No. 2059868, which corresponds to PCT/US2007/077441 and U.S. Application No. 11/956,969, 9 pages. |
| NPL 105 | Search information statement dated February 19, 2009, received in Australian Patent Application No. 2008201540, which corresponds to U.S. Application No. 11/956,969, 2 pages. |
| NPL 106 | Response to Examiners report No.1 dated March 31, 2009, received in Australian Patent Application No. 2008201540, which corresponds to U.S. Application No. 11/956,969, 1 page. |
| NPL 107 | Examiners report No.2 dated April 1, 2009, received in Australian Patent Application No. 2008201540, which corresponds to U.S. Application No. 11/956,969, 2 pages |
| NPL 108 | Response to Examiners report No. 2 dated July 09, 2009, received in Australian Patent Application No. 2008201540, which corresponds to U.S. Application No. 11/956,969, 28 pages. |
| NPL 109 | International search report dated April 8, 2008, received in European Patent No. 2059868, which corresponds to PCT/US2008/077441 and U.S. Application No. 11/956,969, 5 pages. |

| | | | |
|--------------------|--|-----------------|--|
| Examiner Signature | | Date Considered | |
|--------------------|--|-----------------|--|

*EXAMINER: Initial if reference considered, whether or not citation is in conformance with MPEP 609. Draw line through citation if not in conformance and not considered. Include copy of this form with next communication to applicant. ¹ Applicant's unique citation designation number (optional). ² See Kind Codes of USPTO Patent Documents at www.uspto.gov or MPEP 901.04. ³ Enter Office that issued the document, by the two-letter code (WIPO Standard ST.3). ⁴ For Japanese patent documents, the indication of the year of the reign of the Emperor must precede the serial number of the patent document. ⁵ Kind of document by the appropriate symbols as indicated on the document under WIPO Standard ST. 16 if possible. ⁶ Applicant is to place a check mark here if English language Translation is attached.

Burden Hour Statement: This form is estimated to take 2.0 hours to complete. Time will vary depending upon the needs of the individual case. Any comments on the amount of time you are required to complete this form should be sent to the Chief Information Officer, U.S. Patent and Trademark Office, Washington, DC 20231. DO NOT SEND FEES OR COMPLETED FORMS TO THIS ADDRESS. SEND TO: Assistant Commissioner for Patents, P.O. Box 1450, Alexandria, VA 22313-1450.

| | | | | | | |
|--|---------------------------|----|------------------------|--|---------------------|--|
| INFORMATION DISCLOSURE CITATION Substitute for Form 1449-PTO | | | | <i>Electronically filed January 15, 2013</i> | | |
| | | | | Application Number | 90/012,304 | |
| | | | | Filing Date | May 23, 2012 | |
| | | | | First Named Inventor | Bas Ordning | |
| | | | | Art Unit | 3992 | |
| Examiner Name | BONSHOCK, DENNIS G | | Attorney Docket Number | P4304USREX2/120730-002US | | |
| Sheet | 10 | of | 13 | | | |

| | |
|---------|--|
| NPL 110 | Response to Examiners report No. 3 dated August 3, 2009, received in Australian Patent Application No. 2008201540, which corresponds to U.S. Application No. 11/956,969, 1 page. |
| NPL 111 | Notice of acceptance dated August 24, 2009, received in Australian Patent Application No. 2008201540, which corresponds to U.S. Application No. 11/956,969, 1 page. |
| NPL 112 | International search report dated September 9, 2008, received in Australian Patent Application No. 2008201540, which corresponds to WO2008086218 and U.S. Application No. 11/956,969, 7 pages. |
| NPL 113 | International Preliminary report on Patentability July 7, 2009, received in Australian Patent Application No. 2008201540, which corresponds to WO2008086218 and U.S. Application No. 11/956,969, 15 pages. |
| NPL 114 | European search Opinion dated November 18, 2011, received in European Patent Application No. 2402850, which relates to U.S. Application No. 11/956,969, 4 pages. |
| NPL 115 | Search information statement dated February 10, 2009, received in Australian Patent Application No. 2009200366, which corresponds to U.S. Application No. 11/956,969, 2 pages. |
| NPL 116 | Response to examiners report No.1 dated March 12, 2009, received in Australian Patent Application No. 2009200366, which corresponds to U.S. Application No. 11/956,969, 1 page. |
| NPL 117 | Notice of acceptance dated March 31, 2009, received in Australian Patent Application No. 2009200366, which corresponds to U.S. Application No. 11/956,969, 1 page. |
| NPL 118 | European search Opinion dated November 29, 2011, received in European Patent Application No. 2402848, which relates to U.S. Application No. 11/956,969, 3 pages. |
| NPL 119 | Search information statement dated April 08, 2010, received in Australian Patent Application No. 2009208103, which corresponds to U.S. Application No. 11/956,969, 3 pages. |
| NPL 120 | Response to examiners report No.1 dated April 11, 2011, received in Australian Patent Application No. 2009208103, which corresponds to U.S. Application No. 11/956,969, 9 pages. |
| NPL 121 | Reply to communication from Examining Division dated May 5, 2010, received in European Patent No. 2126678, which corresponds to U.S. Application No. 11/956,969, 7 pages. |
| NPL 122 | Examiners report No.1 dated May 16, 2008, received in Australian Patent Application No. 2008100372, which corresponds U.S. Application No. 11/956,969, 1 page. |

| | | | |
|--------------------|--|-----------------|--|
| Examiner Signature | | Date Considered | |
|--------------------|--|-----------------|--|

*EXAMINER: Initial if reference considered, whether or not citation is in conformance with MPEP 609. Draw line through citation if not in conformance and not considered. Include copy of this form with next communication to applicant. ¹ Applicant's unique citation designation number (optional). ² See Kind Codes of USPTO Patent Documents at www.uspto.gov or MPEP 901.04. ³ Enter Office that issued the document, by the two-letter code (WIPO Standard ST.3). ⁴ For Japanese patent documents, the indication of the year of the reign of the Emperor must precede the serial number of the patent document. ⁵ Kind of document by the appropriate symbols as indicated on the document under WIPO Standard ST. 16 if possible. ⁶ Applicant is to place a check mark here if English language Translation is attached.

Burden Hour Statement: This form is estimated to take 2.0 hours to complete. Time will vary depending upon the needs of the individual case. Any comments on the amount of time you are required to complete this form should be sent to the Chief Information Officer, U.S. Patent and Trademark Office, Washington, DC 20231. DO NOT SEND FEES OR COMPLETED FORMS TO THIS ADDRESS. SEND TO: Assistant Commissioner for Patents, P.O. Box 1450, Alexandria, VA 22313-1450.

| | | | | | | | |
|--|----|----|----|--|--|---------------------------------|--|
| INFORMATION DISCLOSURE CITATION Substitute for Form 1449-PTO | | | | <i>Electronically filed January 15, 2013</i> | | | |
| | | | | Application Number | | 90/012,304 | |
| | | | | Filing Date | | May 23, 2012 | |
| | | | | First Named Inventor | | Bas Ordning | |
| | | | | Art Unit | | 3992 | |
| | | | | Examiner Name | | BONSHOCK, DENNIS G | |
| Sheet | 11 | of | 13 | Attorney Docket Number | | P4304USREX2/120730-002US | |

| | |
|---------|---|
| NPL 123 | Search information statement dated May 15, 2008, received in Australian Patent Application No. 2008100372, which corresponds to U.S. Application No. 11/956,969, 1 page. |
| NPL 124 | Response to examiners report No.1 dated September 12, 2008, received in Australian Patent Application No. 2008100372, which corresponds to U.S. Application No. 11/956,969, 18 pages. |
| NPL 125 | Notice of certification dated September 19, 2008, received in Australian Patent Application No. 2008100372, which corresponds to U.S. Application No. 11/956,969, 1 page. |
| NPL 126 | Request for Further Processing, dated October 22, 2012, submitted in European Application No. EP 2 402 848 |
| NPL 127 | Request for Further Processing, dated October 22, 2012, submitted in European Application No. EP 2 402 850 |
| NPL 128 | European search report dated October 18, 2011, received in European Patent Application No. 2390799, which relates to U.S. Application No. 11/956,969, 2 pages. |
| NPL 129 | European search Opinion dated October 31, 2011, received in European Patent Application No. 2390799, which relates to U.S. Application No. 11/956,969, 2 pages. |
| NPL 130 | Rejection Decision dated September 20, 2012, received in Chinese Patent Application No. 20080000019.9, which corresponds to U.S. Application No. 11/956,969 (issued U.S. Patent No. 7,469,381). |
| NPL 131 | Karlson et al., AppLens and LaunchTile: Two Designs for One-Handed Thumb Use on Small Devices, Powerpoint dated 2002 |
| NPL 132 | Technology, Safety, Community, Conference on Human Factors in Computing Systems, CHI 2005, April 2-7, 2005 |
| NPL 133 | CHI 2005 Paper Abstracts, 2005 |
| NPL 134 | CHI 2005 Schedule and Paper Abstracts, 2005 |
| NPL 135 | Forlines et al., Input Techniques for Mobile Interaction, plus..., Mitsubishi Electric Research Laboratories, 2005 |
| NPL 136 | U.S. ITC, Investigation No. 337-TA-797, In the Matter of Certain Portable Electronic Devices and Related Software, excerpts from Markman hearing, February 7, 2012 |
| NPL 137 | U.S. ITC, Investigation No. 337-TA-797, In the Matter of Certain Portable Electronic Devices and Related Software, HTC's Amended Notice of Prior Art, November 7, 2011 |
| NPL 138 | U.S. ITC, Investigation No. 337-TA-797, In the Matter of Certain Portable Electronic Devices and Related Software, excerpts from the evidentiary hearing transcript, August 14, 2012 |

| | | | |
|--------------------|--|-----------------|--|
| Examiner Signature | | Date Considered | |
|--------------------|--|-----------------|--|

*EXAMINER: Initial if reference considered, whether or not citation is in conformance with MPEP 609. Draw line through citation if not in conformance and not considered. Include copy of this form with next communication to applicant. ¹ Applicant's unique citation designation number (optional). ² See Kind Codes of USPTO Patent Documents at www.uspto.gov or MPEP 901.04. ³ Enter Office that issued the document, by the two-letter code (WIPO Standard ST.3). ⁴ For Japanese patent documents, the indication of the year of the reign of the Emperor must precede the serial number of the patent document. ⁵ Kind of document by the appropriate symbols as indicated on the document under WIPO Standard ST. 16 if possible. ⁶ Applicant is to place a check mark here if English language Translation is attached.

Burden Hour Statement: This form is estimated to take 2.0 hours to complete. Time will vary depending upon the needs of the individual case. Any comments on the amount of time you are required to complete this form should be sent to the Chief Information Officer, U.S. Patent and Trademark Office, Washington, DC 20231. DO NOT SEND FEES OR COMPLETED FORMS TO THIS ADDRESS. SEND TO: Assistant Commissioner for Patents, P.O. Box 1450, Alexandria, VA 22313-1450.

| | | | | | | | |
|--|----|----|----|--|--|---------------------------------|--|
| INFORMATION DISCLOSURE CITATION Substitute for Form 1449-PTO | | | | <i>Electronically filed January 15, 2013</i> | | | |
| | | | | Application Number | | 90/012,304 | |
| | | | | Filing Date | | May 23, 2012 | |
| | | | | First Named Inventor | | Bas Ordning | |
| | | | | Art Unit | | 3992 | |
| | | | | Examiner Name | | BONSHOCK, DENNIS G | |
| Sheet | 12 | of | 13 | Attorney Docket Number | | P4304USREX2/120730-002US | |

| | |
|---------|--|
| NPL 139 | U.S. ITC, Investigation No. 337-TA-797, In the Matter of Certain Portable Electronic Devices and Related Software, excerpts from the evidentiary hearing transcript, August 15, 2012 |
| NPL 140 | U.S. ITC, Investigation No. 337-TA-797, In the Matter of Certain Portable Electronic Devices and Related Software, excerpts from the evidentiary hearing transcript, August 16, 2012 |
| NPL 141 | U.S. ITC, Investigation No. 337-TA-797, In the Matter of Certain Portable Electronic Devices and Related Software, excerpts from the evidentiary hearing transcript, August 17, 2012 |
| NPL 142 | U.S. ITC, Investigation No. 337-TA-797, In the Matter of Certain Portable Electronic Devices and Related Software, excerpts from the evidentiary hearing transcript, August 22, 2012 |
| NPL 143 | U.S. ITC, Investigation No. 337-TA-797, In the Matter of Certain Portable Electronic Devices and Related Software, excerpts from the evidentiary hearing transcript, August 24, 2012 |
| NPL 144 | Apple Inc. v. Samsung Electronics Co. Ltd., et al., Nos. ZA11-730 and ZA11-731 (Netherlands), Judgment dated August 23, 2011. |
| NPL 145 | Apple Inc. v. Samsung Electronics Co. Ltd., et al., No. ZA12-220 (Netherlands), Judgment dated November 28, 2012. |
| NPL 146 | Apple Inc. v. Samsung Electronics Co. Ltd., et al., No. ZA12-220 (Netherlands), Judgment dated November 28, 2012. (Convenience English Translation) |
| NPL 147 | HTC User manual HTC P 3050 |
| NPL 148 | Apple v. Samsung, No. (P) NSD 1243 of 2011 (Australia), "Particulars of Invalidity Australian Standard Patent No. 2009208103," May 16, 2012 |
| NPL 149 | Apple v. Samsung, No. (P) NSD 1243 of 2011 (Australia), "Particulars of Invalidity Australian Standard Patent No. 2008100283," May 16, 2012 |
| NPL 150 | Apple v. Samsung, No. (P) NSD 1243 of 2011 (Australia), "Particulars of Invalidity Australian Standard Patent No. 2009200366," May 16, 2012 |
| NPL 151 | Apple v. Samsung, No. (P) NSD 1243 of 2011 (Australia), "Particulars of Invalidity Australian Standard Patent No. 2008100372," May 16, 2012 |
| NPL 152 | Apple v. Samsung, No. (P) NSD 1243 of 2011 (Australia), "Particulars of Invalidity Australian Standard Patent No. 2008201540," May 16, 2012 |
| NPL 153 | Apple v. HTC, Nos. HC11 C02826, HC11 C02703, HC11 C03080 (UK), Judgment dated July 4, 2012 |
| NPL 154 | Apple v. HTC, Nos. HC11 C02826, HC11 C02703, HC11 C03080 (UK), Hearing Transcript May 1, 2012 |

| | | | |
|--------------------|--|-----------------|--|
| Examiner Signature | | Date Considered | |
|--------------------|--|-----------------|--|

*EXAMINER: Initial if reference considered, whether or not citation is in conformance with MPEP 609. Draw line through citation if not in conformance and not considered. Include copy of this form with next communication to applicant. ¹ Applicant's unique citation designation number (optional). ² See Kind Codes of USPTO Patent Documents at www.uspto.gov or MPEP 901.04. ³ Enter Office that issued the document, by the two-letter code (WIPO Standard ST.3). ⁴ For Japanese patent documents, the indication of the year of the reign of the Emperor must precede the serial number of the patent document. ⁵ Kind of document by the appropriate symbols as indicated on the document under WIPO Standard ST. 16 if possible. ⁶ Applicant is to place a check mark here if English language Translation is attached.

Burden Hour Statement: This form is estimated to take 2.0 hours to complete. Time will vary depending upon the needs of the individual case. Any comments on the amount of time you are required to complete this form should be sent to the Chief Information Officer, U.S. Patent and Trademark Office, Washington, DC 20231. DO NOT SEND FEES OR COMPLETED FORMS TO THIS ADDRESS. SEND TO: Assistant Commissioner for Patents, P.O. Box 1450, Alexandria, VA 22313-1450.

| | | | | | | | |
|--|----|----|----|--|---------------------------------|---------------------------|--|
| INFORMATION DISCLOSURE CITATION Substitute for Form 1449-PTO | | | | <i>Electronically filed January 15, 2013</i> | | | |
| | | | | Application Number | | 90/012,304 | |
| | | | | Filing Date | | May 23, 2012 | |
| | | | | First Named Inventor | | Bas Ordning | |
| | | | | Art Unit | | 3992 | |
| | | | | Examiner Name | | BONSHOCK, DENNIS G | |
| Sheet | 13 | of | 13 | Attorney Docket Number | P4304USREX2/120730-002US | | |

| | |
|---------|--|
| NPL 155 | Apple v. HTC, Nos. HC11 C02826, HC11 C02703, HC11 C03080 (UK), Hearing Transcript May 2, 2012 |
| NPL 156 | Apple v. HTC, Nos. HC11 C02826, HC11 C02703, HC11 C03080 (UK), Hearing Transcript May 3, 2012 |
| NPL 157 | Apple v. HTC, Nos. HC11 C02826, HC11 C02703, HC11 C03080 (UK), Hearing Transcript May 8, 2012 |
| NPL 158 | Apple v. HTC, Nos. HC11 C02826, HC11 C02703, HC11 C03080 (UK), Hearing Transcript May 9, 2012 |
| NPL 159 | Apple v. HTC, Nos. HC11 C02826, HC11 C02703, HC11 C03080 (UK), Hearing Transcript May 0, 2012 |
| NPL 160 | Apple v. HTC, Nos. HC11 C02826, HC11 C02703, HC11 C03080 (UK), Hearing Transcript May 11, 2012 |
| NPL 161 | Apple Inc. v. Samsung Electronics Co., Case no. 11-cv-01846 (N.D. Cal.), deposition transcript of Van Dam, dated May 2, 2012 |
| NPL 162 | Apple Inc. v. Samsung Electronics Co., Case no. 11-cv-01846 (N.D. Cal.), deposition transcript of Van Dam, dated September 14, 2011 |
| NPL 163 | Apple Inc. v. Samsung Electronics Co., Case no. 11-cv-01846 (N.D. Cal.), Declaration of Benjamin Bederson, August 20, 2011 |
| NPL 164 | Apple Inc. v. Samsung Electronics Co., Case no. 11-cv-01846 (N.D. Cal.), Videotaped Deposition of Benjamin Bederson, Transcript, September 17, 2011 |
| NPL 165 | Apple Inc. v. Samsung Electronics Co., Case no. 11-cv-01846 (N.D. Cal.), excerpts from Apple's Motion for a Preliminary Injunction, filed 07-01-2011 |
| NPL 166 | Apple Inc. v. Samsung Electronics Co., Case no. 11-cv-01846 (N.D. Cal.), declaration of Ravin Balakrishnan in support of Apple's motion for a preliminary injunction, filed 07-01-2011 |
| NPL 167 | Apple Inc. v. Samsung Electronics Co., Case no. 11-cv-01846 (N.D. Cal.), excerpts from Samsung's opposition to Apple's motion for preliminary injunction, filed 11-29-2011 |
| NPL 168 | Apple Inc. v. Samsung Electronics Co., Case no. 11-cv-01846 (N.D. Cal.), declaration of Van Dam in support of Samsung's motion in opposition to preliminary injunction, filed 11-29-2011 |
| NPL 169 | Apple Inc. v. Samsung Electronics Co., Case no. 11-cv-01846 (N.D. Cal.), excerpts from Apple's reply motion for Preliminary Injunction, filed September 30, 2011 |
| | |

| | | | |
|--------------------|--|-----------------|--|
| Examiner Signature | | Date Considered | |
|--------------------|--|-----------------|--|

*EXAMINER: Initial if reference considered, whether or not citation is in conformance with MPEP 609. Draw line through citation if not in conformance and not considered. Include copy of this form with next communication to applicant. ¹ Applicant's unique citation designation number (optional). ² See Kind Codes of USPTO Patent Documents at www.uspto.gov or MPEP 901.04. ³ Enter Office that issued the document, by the two-letter code (WIPO Standard ST.3). ⁴ For Japanese patent documents, the indication of the year of the reign of the Emperor must precede the serial number of the patent document. ⁵ Kind of document by the appropriate symbols as indicated on the document under WIPO Standard ST. 16 if possible. ⁶ Applicant is to place a check mark here if English language Translation is attached.

Burden Hour Statement: This form is estimated to take 2.0 hours to complete. Time will vary depending upon the needs of the individual case. Any comments on the amount of time you are required to complete this form should be sent to the Chief Information Officer, U.S. Patent and Trademark Office, Washington, DC 20231. DO NOT SEND FEES OR COMPLETED FORMS TO THIS ADDRESS. SEND TO: Assistant Commissioner for Patents, P.O. Box 1450, Alexandria, VA 22313-1450.

IN THE UNITED STATES PATENT AND TRADEMARK OFFICE

Reexam Application No.: 90/012,304
For: US 7,469,381 B2
Filing Date: 05-23-2012
Art Unit: 3992
Examiner: BONSHOCK, DENNIS G.
Attorney Docket No.: P4304USREX2/120730-002US

INFORMATION DISCLOSURE STATEMENT

Mail Stop *Ex Parte Reexam*
Central Reexamination Unit
Commissioner for Patents
P.O. Box 1450
Alexandria, VA 22313-1450

January 15, 2013

Sir:

In accordance with the duty of disclosure provisions of 37 C.F.R. §1.56, there is hereby provided certain information which the Examiner may consider material to the reexamination of the subject U.S. patent. This information is supplemental to the disclosure made on October 9, 2012 in the above-captioned application. It is requested that the Examiner make this information of record if it is deemed material to the reexamination. To accommodate technical limitations in the EFS system, copies of reference documents for this Information Disclosure Statement are being submitted in several successive EFS submissions. It is respectfully requested that all such documents be considered together as one disclosure.

Enclosures accompanying this Information Disclosure Statement are:

- a. A list of all patents, publications, applications, or other information submitted for consideration by the office
- b. A legible copy of:
 - Each foreign patent;
 - Each publication or that portion which caused it to be listed on PTO-1449; and
 - all other information or portion which caused it to be listed on the PTO-1449
- c. if included, an English language copy search report(s) from a counterpart foreign application or PCT International search report.

Under MPEP 2202, “[a]ny person at any time may cite to the Office in writing prior art consisting of patents or printed publications...Such citations may be made without payment of a fee.” It is accordingly believed that no fee is required. If any fee is deemed required, the Commissioner is authorized to charge any additional fee required for this Information Disclosure Statement to Goldberg, Lowenstein & Weatherwax LLP Deposit Account No. 50-5927 (order no. 120730-002US).

Copies of each cited U.S. patent and each U.S. patent application publication are not enclosed, pursuant to the USPTO OG Notice dated 05 August 2003, waiving the requirement under 37 C.F.R. 1.98(a)(2)(i) for U.S. patent applications filed after June 30, 2003.

No admission is made that the information cited in this Statement is, or is considered to be, material to patentability nor a representation that a search has been made (other than a search report of a foreign counterpart application or PCT International Search Report if submitted herewith). 37 C.F.R. §§1.97(g) and (h).

Date: January 15, 2013

Respectfully Submitted,

/Kenneth J. Weatherwax/
Kenneth J. Weatherwax (Reg. No. 54,528)
Goldberg, Lowenstein & Weatherwax LLP
11400 W. Olympic Blvd., Suite 400
Los Angeles, California 90064
(310) 203-9344

Electronic Acknowledgement Receipt

| | |
|---|--|
| EFS ID: | 14709458 |
| Application Number: | 90012304 |
| International Application Number: | |
| Confirmation Number: | 4807 |
| Title of Invention: | LIST SCROLLING AND DOCUMENT TRANSLATION, SCALING, AND ROTATION ON A TOUCH-SCREEN DISPLAY |
| First Named Inventor/Applicant Name: | 7,469,381 |
| Customer Number: | 108491 |
| Filer: | Kenneth James Weatherwax |
| Filer Authorized By: | |
| Attorney Docket Number: | P4304USREX2/120730-002US |
| Receipt Date: | 15-JAN-2013 |
| Filing Date: | 23-MAY-2012 |
| Time Stamp: | 23:15:17 |
| Application Type: | Reexam (Third Party) |

Payment information:

| | |
|------------------------|----|
| Submitted with Payment | no |
|------------------------|----|

File Listing:

| Document Number | Document Description | File Name | File Size(Bytes)/ Message Digest | Multi Part /.zip | Pages (if appl.) |
|-----------------|-----------------------|---|---|------------------|------------------|
| 1 | Non Patent Literature | NPL41_Johnson_Collection_Pa pers_FirstPerson.pdf | 8935686 f35558e44dab0663b86e4065d99d1fa68ac aa3ea | no | 91 |

Warnings:**Information:**

| | | | | | |
|---|--|---------------------------------------|--|----|-----|
| 2 | Non Patent Literature | NPL42_Johnson_Touch_Displays.pdf | 793863 2bd08c2794479f8a9e645de7791fbee651c4ff6 | no | 8 |
| Warnings: | | | | | |
| Information: | | | | | |
| 3 | Non Patent Literature | NPL43_KARLSON_Applens_Powerpoint.pdf | 3002793 ece33c26e7fa553e6435235ebad6b59b83ff7dd4 | no | 50 |
| Warnings: | | | | | |
| Information: | | | | | |
| 4 | Non Patent Literature | NPL44_KROLIK_PIV_Creator.pdf | 2094957 37d6f7f849fc22456e493e23b74038cb0946397 | no | 3 |
| Warnings: | | | | | |
| Information: | | | | | |
| 5 | Non Patent Literature | NPL45_Krueger_Artificial_Reality.pdf | 18699702 e0774f0521397b03a97a258fdd238ad242b56680 | no | 328 |
| Warnings: | | | | | |
| Information: | | | | | |
| 6 | Reexam Certificate of Service | 20130115_IDS_381_COS_EFS.pdf | 78034 9e35ece2655cef146e8e50b569f1ff6c306a7631 | no | 1 |
| Warnings: | | | | | |
| Information: | | | | | |
| 7 | Information Disclosure Statement (IDS) Form (SB08) | 20130115_IDS_381_FINAL_EFS.pdf | 823577 fcc2b7e3186c23b8e0dabd913f529a8fe7567de1 | no | 13 |
| Warnings: | | | | | |
| Information: | | | | | |
| This is not an USPTO supplied IDS fillable form | | | | | |
| 8 | Transmittal Letter | 20130115_IDS_381_trans_letter_EFS.pdf | 97375 0b3f196813c8a4f1ef7a89ab0ce8e404e0d3e4c0 | no | 2 |
| Warnings: | | | | | |
| Information: | | | | | |
| Total Files Size (in bytes): | | | 34525987 | | |

This Acknowledgement Receipt evidences receipt on the noted date by the USPTO of the indicated documents, characterized by the applicant, and including page counts, where applicable. It serves as evidence of receipt similar to a Post Card, as described in MPEP 503.

New Applications Under 35 U.S.C. 111

If a new application is being filed and the application includes the necessary components for a filing date (see 37 CFR 1.53(b)-(d) and MPEP 506), a Filing Receipt (37 CFR 1.54) will be issued in due course and the date shown on this Acknowledgement Receipt will establish the filing date of the application.

National Stage of an International Application under 35 U.S.C. 371

If a timely submission to enter the national stage of an international application is compliant with the conditions of 35 U.S.C. 371 and other applicable requirements a Form PCT/DO/EO/903 indicating acceptance of the application as a national stage submission under 35 U.S.C. 371 will be issued in addition to the Filing Receipt, in due course.

New International Application Filed with the USPTO as a Receiving Office

If a new international application is being filed and the international application includes the necessary components for an international filing date (see PCT Article 11 and MPEP 1810), a Notification of the International Application Number and of the International Filing Date (Form PCT/RO/105) will be issued in due course, subject to prescriptions concerning national security, and the date shown on this Acknowledgement Receipt will establish the international filing date of the application.

IN THE UNITED STATES PATENT AND TRADEMARK OFFICE

In re: Reexam of U.S. Patent No. 7,469,381 B2

Control No. 90/012,304

Filed: May 23, 2012

For: **LIST SCROLLING AND DOCUMENT
TRANSLATION, SCALING, AND
ROTATION ON A TOUCH-SCREEN
DISPLAY**

Confirmation No.: 4807

Art Unit: 3992

Examiner: Bonshock, Dennis G

Atty. Docket:

: P4304USREX2/120730-002US

Certificate of Service

Mail Stop *Ex Parte* Reexam
Central Reexamination Unit
Commissioner for Patents
United States Patent and Trademark Office
P.O. Box 1450
Alexandria, VA 22313-1450

January 15, 2013

Sir:

In compliance with 37 C.F.R. § 1.550(f), the undersigned, on behalf of the Patent Owner, hereby certifies that copies of the following documents are being served on the Third Party Requester by first class mail on January 15, 2013.

1. Information Disclosure Statement citing documents US1-US3; USA1-USA10; FP1-FP63 and NPL1-NPL169;
2. Copies of cited documents FP1-FP63 and NPL1-NPL169 (on a disc);

The name and address of the party being served is as follows:

Joseph J. Richetti
BRYAN CAVE LLP
1290 Avenue of the Americas
New York, New York 10104

Very truly yours,

/Kenneth J. Weatherwax/

Kenneth J. Weatherwax, Reg. No. 54,528
Goldberg, Lowenstein & Weatherwax LLP
11400 W. Olympic Blvd., Suite 400
Los Angeles, CA 90064